









Vehicle list



					
---	---	---	--	---	---

ASKAM CHRYSLER (TÜRKIYE)



AS 700 - 800 - 900 - 950

AS 700-800-900-950 (Perkins Mot.)				3593.30.00	350 10 350 GSZ	
AS 950 (Deutz Mot.)				3868.20.00	380 15" GM380	
				3884.30.00	380 10 15" 380GSZ	

26.200 - 26.235 - 32.260





26.200				3868.20.00	380 15" GM380	
				3884.30.00	380 10 15" 380GSZ	
32.260 / 26.235 (J08 Mot.)				3868.20.00	380 15" GM380	

Hi-Ex Ser.19.300-26.300-32.300























Hi - Ex Serisi				3962.20.00	395 15.5" MF 395	
				3965.30.00	395 10 15.5" 395GTZ	

ASTRA

BE-series

BE 8440 F				4297.30.00	420 10 420GSZ	
				8514.40.00	KZI - 4,5	
Betonmischer 304 F/FP/M/MP				4253.20.00	420 GFX420KR	
				4266.30.00	420 10 420/210GSZ	
Betonmischer 20 257				8514.40.00	KZI - 4,5	- For PTO

HD 7 01.96 -















64.38	01.96 -	8210.42K.		4300.90.04	430 10 MFZ430	
				4301.20.00	430WGTZ	
				4326.30.00	KZISZ - 5	
				8919.40.00		
42.42 64.42 66.42	01.96 - 01.96 - 01.96 -	8210.42L.		4300.90.04	430 10 MFZ430	
				4301.20.00	430WGTZ	
				4326.30.00	KZISZ - 5	
				8919.40.00		
64.45 86.45	01.96 - 01.96 -	8280.42B		4300.90.04	430 10 MFZ430	
				4301.20.00	430WGTZ	
				4326.30.00	KZISZ - 5	
				8919.40.00		
64.52 66.52 84.52 86.52	01.96 - 01.96 - 01.96 - 01.98 -	8280.42S. TCA		4300.90.04	430 10 MFZ430	
				4301.20.00	430WGTZ	
				4326.30.00	KZISZ - 5	
				8919.40.00		
66.38	01.96 -	8210.42K.		4300.90.04	430 10 MFZ430	
				4301.20.00	430WGTZ	
				4326.30.00	KZISZ - 5	
				8919.40.00		
				4301.20.00	430 MFZ430	
	4326.30.00	430 10 430WGTZ				
	8919.40.00	KZISZ - 5				

Vehicle list



ASTRA

HD 7 01.96 -

66.45	01.96 -	8280.42B	 4300.90.04  4301.20.00  4326.30.00  8919.40.00	430 10 MFZ430 430WGTZ KZISZ - 5	
			 4301.20.00	430 MFZ430	
			 4326.30.00	430 10 430WGTZ	
			 8919.40.00	KZISZ - 5	
42.42 T	01.96 -	8210.42K.	 4300.90.04	430 10 MFZ430	- Engine code: 8210.42L
44.34	01.96 -	8210.42L.	 4301.20.00	MFZ430	- Engine code: 8280.42B
44.38	01.96 -	8210.42M	 4326.30.00	430WGTZ	- Engine code: 8280.42S
44.38 T	01.96 -	8280.42B	 8919.40.00	KZISZ - 5	- Use release fork with cam
44.42 T	01.96 -	8280.42S. TCA	 4300.90.176	430 10 MFZ430	- Engine code: 8210.42L
64.34	01.96 -	8460.41K.	 4301.20.00	MFZ430	- Engine code: 8280.42B
64.38 T	01.96 -		 4326.30.00	430WGTZ	- Engine code: 8280.42S
64.42 T	01.96 -		 8939.40.00	KZISZ - 5	- Use release fork with rollers
64.45 T	01.96 -				
64.47	01.96 -				
64.52 T	01.96 -				
66.42 T	01.96 -				
66.45 T	01.96 -				
66.52 T	01.96 -				
84.47	01.96 -				
86.42	01.96 -				

Vehicle list



ASTRA

HD 7-C 01.00 -

42.36	01.00 -	F3BE0681D		4300.90.04	430 10	- Engine code: 8210.42L
42.36 T	01.00 -	F3BE0681F		4301.20.00	MFZ430	- Engine code: 8210.42K
42.38		F3BE0681H		4326.30.00	430WGTZ	- Engine code: 8280.42S
42.40	01.00 -	F3BE0681J		8919.40.00	KZISZ - 5	- Use release fork with cam
42.40 T	01.00 -			4300.90.176	430 10	- Engine code: 8210.42L
42.45	01.00 -			4301.20.00	MFZ430	- Engine code: 8210.42K
42.45 T	01.00 -			4326.30.00	430WGTZ	- Engine code: 8280.42S
44.36	01.00 -			8939.40.00	KZISZ - 5	- Use release fork with rollers
44.36 T	01.00 -					
44.40	01.00 -					
44.40 T	01.00 -					
44.45	01.00 -					
44.45 T	01.00 -					
64.36	01.00 -					
64.36 T	01.00 -					
64.40	01.00 -					
64.40 T	01.00 -					
64.45	01.00 -					
64.45 T	01.00 -					
64.50	01.00 -					
64.50 T	01.00 -					
84.36	01.00 -					
66.36	01.00 -					
84.38						
66.36 T	01.00 -					
84.40	01.00 -					
84.42						
66.40	01.00 -					
84.45	01.00 -					
66.40 T	01.00 -					
84.50	01.00 -					
66.45	01.00 -					
66.45 T	01.00 -					
66.50	01.00 -					
66.50 T	01.00 -					
86.40	01.00 -					
86.45	01.00 -					
86.50	01.00 -					
88.45	01.00 -					
88.50	01.00 -					

HD 8 01.05 -

42.33	06.07 -	F2BE3681A		4300.90.68	430 10	- GBox: AS Tronic
42.36	06.07 -	F2BE3681B		4303.20.00	MFZ430	- Use release fork with rollers
44.33	06.07 -			4331.30.00	430WGTZ	
44.36	06.07 -			8939.40.00	KZISZ - 5	
				4300.90.94	430 10	- GBox: Ecosplit, AS Tronic
				4303.20.00	MFZ430	- Use release fork with cam
				4331.30.00	430WGTZ	
				8919.40.00	KZISZ - 5	

Vehicle list



ASTRA

HD 8 01.05 -

42.36	01.05 -	F3BE0681A		4300.90.04	430 10	- GBox: Ecosplit
42.36 T	01.05 -	F3BE0681D		4301.20.00	MFZ430	- Use release fork with cam
42.40	01.05 -	F3BE0681H		4326.30.00	430WGTZ	
42.40 T	01.05 -	F3BE0681J		8919.40.00	KZISZ - 5	
42.41	03.07 -	F3BE0681K		4300.90.176	430 10	- GBox: Ecosplit
42.45	01.05 -	F3BE3681D		4301.20.00	MFZ430	- Use release fork with rollers
42.45 T	01.05 -	F3BE3681F		4326.30.00	430WGTZ	
42.50	01.05 -	F3BE3681G		8939.40.00	KZISZ - 5	
42.50 T	01.05 -					
42.48	03.07 -					
44.36	01.05 -					
44.36 T	01.05 -					
44.40, 44.41	01.05 -					
44.40 T	01.05 -					
44.45 T	01.05 -					
44.50	01.05 -					
44.50 T	01.05 -					
64.36	01.05 -					
64.36 T	01.05 -					
64.40	01.05 -					
64.40 T	01.05 -					
64.45	01.05 -					
64.45 T	01.05 -					
64.50	01.05 -					
64.50 T	01.05 -					
66.36	01.05 -					
66.36 T	01.05 -					
66.40	01.05 -					
66.40 T	01.05 -					
66.45	01.05 -					
66.45 T	01.05 -					
66.50	01.05 -					
66.50 T	01.05 -					
84.36	01.05 -					
84.40, 84.41	01.05 -					
84.50	01.05 -					
84.54	01.05 -					
86.54	01.05 -					
86.40	01.05 -					
86.44, 86.45	01.05 -					
88.45	01.05 -					
88.50	01.05 -					
88.54	01.05 -					

Vehicle list









ASTRA





HD 8 01.05 -

42.41 T	03.07 -	F3BE0681D		4300.90.110	430 10	- GBox: Ecosplit
42.44	03.07 -	F3BE0681K		4390.20.00	MFZ430	
42.44 T	03.07 -	F3BE3681A		4390.30.00	430WGTZ	
42.48 T	03.07 -	F3BE3681D		8919.40.00	KZISZ - 5	
42.52 T	03.07 -	F3BE3681E				
42.56 T	03.07 -	F3BE3681F				
44.44, 44.45	01.05 -	F3BE3681G				
44.44 T	03.07 -					
44.48	03.07 -					
44.48 T	03.07 -					
44.52 T	03.07 -					
44.56 T	03.07 -					
64.41	03.07 -					
64.41 T	03.07 -					
64.44	03.07 -					
64.44 T	03.07 -					
64.48	03.07 -					
64.48 T	03.07 -					
64.52	03.07 -					
64.52 T	03.07 -					
64.56	03.07 -					
64.56 T	03.07 -					
66.41	03.07 -					
66.41 T	03.07 -					
66.44	03.07 -					
66.44 T	03.07 -					
66.48	03.07 -					
66.48 T	03.07 -					
66.52	03.07 -					
66.52 T	03.07 -					
66.56	03.07 -					
66.56 T	03.07 -					
84.44, 84.45	01.05 -					
84.48	03.07 -					
84.52	03.07 -					
84.56	03.07 -					
86.48	03.07 -					
86.50	01.05 -					
86.52	03.07 -					
86.56	03.07 -					
88.48	03.07 -					
88.52	03.07 -					
88.56	03.07 -					
44.41 T	03.07 -	F3BE0681A		4300.90.109	4300 10	- Engine code: F3BE3681
66.54	03.07 -	F3BE3681D		4390.20.00	MFZ430	- GBox: 12AS2330TO
				4390.30.00	430WGTZ	
				8939.40.00	KZISZ - 5	
				4300.90.110	430 10	- Engine code: F3BE3681
				4390.20.00	MFZ430	- GBox: 16S2220TO, 12AS2330TO
				4390.30.00	430WGTZ	
				8919.40.00	KZISZ - 5	



Vehicle list

					
---	---	---	--	---	---





AVIA

D-Line		10.01 -				
D 60, 110kW	10.01 -	ISBe 150		3601.20.00	362 MF362	- GBox: ZF S5-42
D 60, 125kW	10.01 -	ISBe 170				
D 75, 110kW	10.01 -					
D 75, 125kW	10.01 -					
D 75 T, 110kW	10.01 -					
D 75 T, 125kW	10.01 -					
D 90, 110kW	10.01 -	ISBe 150		3601.20.00	362 MF362	- GBox: ZF 6S850
D 90, 125kW	10.01 -	ISBe 170				
D 100, 110kW	10.01 -	ISBe 150		3608.20.00	362 MF362	
D 100, 125kW	10.01 -	ISBe 170				
D 120, 110kW	10.01 -			6905.40.00	KZIS - 3	
D 120, 125kW	10.01 -					













TRUCK

D 60 / D75 (zgg.6200kg)				3601.20.00	362 MF362	- GBox: ZF S5-42
D 60 / D75 (zgg.7490kg)				3601.20.00	362 MF362	- GBox: ZF S5-42
D 75 T Urban Tractor (zgg.10990kg)						
D 90 (zgg. 9000kg)				3601.20.00	362 MF362	- GBox: ZF 6S850

BARKAS

B 1000 Box (KM)		01.76 -				
1.0	01.76 - 12.91	353-1/B1000		1800.90.02	180 24 T180120 180DE2R KZI - 0	
				1801.20.00		
				1801.30.00		
				3212.40.00		

BMC (TÜRKİYE)















YAVUZ SERISI						
YAVUZ 1850				3594.30.00	350 10 14" 350GSZ	
YAVUZ 2200				3868.20.00	380 15" GM380	
FATİH SERISI						
FATİH 105-110				3259.30.00	325 10 13" 325GS	
FATİH 162.25-145.22				3594.30.00	350 10 14" 350GSZ	
FATİH 180				3574.20.00	350 14" MF 350	
				3574.30.00	350 10 14" 350GSZ	
FATİH 200.26				3592.30.00	350 10 14" 350GSZ	
DEV FATİH 214.26-220.26				3868.20.00	380 15" GM380	
				3884.30.00	380 10 15" 380GSZ	
FATİH 270-280				3568.30.00	350 10 14" 350GSZ	
				3569.30.00	350 10 14" 350GSZ	
FATİH 280				4304.20.00	430 MFZ430	
				4317.30.00	430 10 17" 430WGTZ	

Vehicle list

					
---	---	---	--	---	---











BMC (TÜRKIYE)

PROFESYONEL SERISI







PRO 518-522 (Nissan Mot)				3259.30.00	325 10 13" 325GS	
PRO 522-518 (Cummins Mot)				3574.20.00	350 14" MF 350	
				3574.30.00	350 10 14" 350GSZ	
PRO 522-617-620-624				3574.20.00	350 14" MF 350	
				3578.30.00	350 10 14" 350GSZ	
PRO 827-832				3568.30.00	350 10 14" 350GSZ	
				3569.30.00	350 10 14" 350GSZ	
PRO 625				3962.20.00	395 15.5" MF 395	
				3965.30.00	395 10 15.5" 395GTZ	
PRO 827	01.06 -			4304.20.00	430 MFZ430	
				4317.30.00	430 10 17" 430WGTZ	
PRO 935				4304.20.00	430 MFZ430	
				4328.30.00	430 10 17" 430WGTZ	
PRO 1142				4308.20.00	430 MFZ430	
				4328.30.00	430 10 17" 430WGTZ	

DAF

A-series



A 16 DF A 1600 DF A 3200 DF				3107.20.00	310 GF310K	
A 18 DH				3521.20.00	350 GF350KR	- GBox: AK/S5-352
				3563.30.00	350 10 350GSZ	- GBox: AK/S5-352
A 1602 DD A 1602 DF A 1700 DF A 1700 DSD A 1900 DS A 1902 DS AS 1900 DS AT 1902 DS				3521.20.00	350 GF350KR	
				3563.30.00	350 10 350GSZ	
A 2200 DKD				4205.20.00	420 G420KR	
				4208.30.00	420 10 420GS	
				8514.40.00	KZI - 4,5	
A 2400 DK AE 2400 DK AT 2400 DK ATE 2400 DK				4205.20.00	420 G420KR	
				4208.30.00	420 10 420GS	
				8514.40.00	KZI - 4,5	

Vehicle list





					
---	---	---	--	---	---

DAF





A-series

AE 17 DD			 3521.20.00	350 GF350KR	- GBox: AK/S 5-35-2
AE 17 DF			 3563.30.00	350 10 350GSZ	- GBox: AK/S 5-35-2
AE 18 DF			 3563.30.00	350 10 350GSZ	- GBox: AK/S 5-35-2





B-series

B 1600 DF			 3521.20.00	350 GF350KR	
			 3563.30.00	350 10 350GSZ	
B 1600 DS			 3521.20.00	350 GF350KR	- GBox: AK/S 5-35-2
B 1600 DT			 3563.30.00	350 10 350GSZ	- GBox: AK/S 5-35-2





DM

DM 15			 3521.20.00	350 GF350KR	- GBox: AK/S 5-35-2
DM 16			 3563.20.00	350 GMF350	- GBox: AK/S 5-35-2
DM 17			 4205.20.00	420 G420KR	
DM 18			 4208.30.00	420 10 420GS	
			 8514.40.00	KZI - 4,5	





F 900

FA 900 BDF	11.81 - 11.88	DF 615	 3500.90.05	350 10	
FA 900 BDT	11.83 - 11.88	DT 615	 3573.20.00	MF350	
			 3563.30.00	350GSZ	
			 6905.40.00	KZIS - 3	













F 1100

FA 1100 DD	01.78 - 12.81	DD 575	 3500.90.05	350 10	
FA 1100 DF	11.81 - 11.88	DF 615	 3573.20.00	MF350	
FA 1100 DNTD	12.86 - 11.90	DNTD 620	 3563.30.00	350GSZ	
FA 1100 DT	11.83 - 11.88	DT 615	 6905.40.00	KZIS - 3	

F 1200

FA 1200 DD	01.69 - 12.81	DD 575	 3500.90.05	350 10	
			 3573.20.00	MF350	
			 3563.30.00	350GSZ	
			 6905.40.00	KZIS - 3	

F 1300

F 1300			 3500.90.05	350 10	- GBox: ZF 6S-36
F 1300 DF			 3573.20.00	MF350	
			 3563.30.00	350GSZ	
			 6905.40.00	KZIS - 3	
			 3160.20.00	310 MF310	
FA 1300			 3160.20.00	310 MF310	- GBox: DF615
			 3563.20.00	350 GMF350	
			 3565.20.00	350 GMF350	
			 3563.30.00	350 10 350GSZ	
			 3500.90.05	350 10	- GBox: ZF 6S-36
			 3573.20.00	MF350	
			 3563.30.00	350GSZ	
			 6905.40.00	KZIS - 3	

Vehicle list



DAF

F 1300

FA 1300 DF	07.78 - 10.88	DF 615	3500.90.05	350 10	- GBox: ZF 6S-36
FA 1300 DNT,FA 1300 NT	12.86 - 12.92	DNT 620	3573.20.00	MF350	
FA 1300 DNTD,FA 1300 NB	12.86 - 12.92	DNTD 620	3563.30.00	350GSZ	
FA 1300 DT	07.78 - 02.90	DT 615	6905.40.00	KZIS - 3	
FA 1305 DT	07.78 - 02.90	NT 116			
FA 1300 DT-B	07.78 - 02.90	NT 133			

F 1400

F 1400 DF			3107.20.00	310 GF310K	
FA 1400 DD	02.72 - 12.81	DD 575	3500.90.05	350 10	
			3573.20.00	MF350	
			3563.30.00	350GSZ	
			6905.40.00	KZIS - 3	

F 1500

F 1500 DF			3500.90.05	350 10	- GBox: ZF 6S-36
			3573.20.00	MF350	
			3563.30.00	350GSZ	
			6905.40.00	KZIS - 3	
			3160.20.00	310 MF310	
FA 1500			3160.20.00	310 MF310	- GBox: DF615
			3563.20.00	350 GMF350	
			3565.20.00	350 GMF350	
			3563.30.00	350 10 350GSZ	
FA 1500 DF,FD 1500 DF	07.78 - 08.91	DF 615	3500.90.05	350 10	- GBox: ZF S6-36
FA 1500 DT,FD 1500 DT	07.78 - 08.91	DT 615	3573.20.00	MF350	
FT 1500 DT	07.78 - 08.91		3563.30.00	350GSZ	
			6905.40.00	KZIS - 3	

F 1600

F 1600			3581.20.00	350 GMF350KR	- GBox: ZF 6S-36
			3563.30.00	350 10 350GSZ	- GBox: ZF 6S-36
			3564.30.00	350 10 350GSZ	- GBox: ZF 6S-36
			6905.40.00	KZIS - 3	- GBox: ZF 6S-36
			3521.20.00	350 GF350KR	- GBox: S 8-48-2
			3583.30.00	350 10 350GSZ	- GBox: S 8-45-2
F 1600 DT		DF 615	3581.20.00	350 GMF350KR	- GBox: ZF 6S-36
FA 1600 DF, Platform/Chassis	01.70 - 08.91		3563.30.00	350 10 350GSZ	- GBox: ZF 6S-36
FA 1600 DF, Dump Truck	01.70 - 08.91		3564.30.00	350 10 350GSZ	- GBox: ZF 6S-36
FA 1600 DF 420			6905.40.00	KZIS - 3	- GBox: ZF 6S-36
FA 1605 DF			3107.20.00	310 GF310K	
FAS 1600 DF					
FT 1600 DF					

Vehicle list



DAF

F 1600

FA 1600 DT, Platform/Chassis	01.73 - 08.91	DT 615		3581.20.00	350 GMF350KR	- GBox: ZF 6S-36
FA 1600 DT, Dump Truck	01.73 - 08.91			3564.30.00	350 10 350GSZ	- GBox: ZF 6S-36
FGG 1600 DT, FGG 1621 DT	01.73 - 08.91			3563.30.00	350 10 350GSZ	- GBox: ZF 6S-36
FT 1600 DT	01.73 - 08.91			6905.40.00	KZIS - 3	- GBox: ZF 6S-36
FA 1600 DTD				3581.20.00	350 GMF350KR	- GBox: ZF 6S-36
FAS 1600 DTD				3563.30.00	350 10 350GSZ	- GBox: ZF 6S-36
FH 1600 DTD				3564.30.00	350 10 350GSZ	- GBox: ZF 6S-36
FM 1600 DF				6905.40.00	KZIS - 3	- GBox: ZF 6S-36
FT 1600 DTD				3521.20.00	350 GF350KR	
FA 1605 DT				3581.20.00	350 GMF350KR	- GBox: ZF 6S-36
FA 1605 DTD				3563.30.00	350 10 350GSZ	- GBox: ZF 6S-36 - GBox: AK/S 5-35-2 - GBox: S 8-45-2
				3564.30.00	350 10 350GSZ	- GBox: ZF 6S-36
				6905.40.00	KZIS - 3	- GBox: ZF 6S-36
				3521.20.00	350 GF350KR	- GBox: AK/S 5-35-2 - GBox: S 8-45-2

F 1700

FA 1700 DNT, FA 1700 NT	12.86 - 02.95	DNT 620		3500.90.39	350 10	- GBox: ZF S6-36
FA 1700 DNTD, FA 1700 NB, FD 1700 DNTD, FD 1700 NB	12.86 - 02.95	DNTD 620 NT 116 NT 133		3573.20.00	MF350	
				3564.30.00	350GSZ	
				8505.40.00	KZI - 4,5	
FA 1700 DNS	01.88 - 02.95	DNS 620		3500.90.05	350 10	- GBox: ZF S6-36
FAG 1700 DNT, FAG 1700 NT	12.86 - 02.95	DNT 620		3573.20.00	MF350	
FAG 1700 DNTD, FAG 1700 NB	12.86 - 02.95	DNTD 620 NT 116 NT 133		3563.30.00	350GSZ	
				6905.40.00	KZIS - 3	

F 1800

FAV 1800 DT	01.70 - 08.91	DT 615		3563.20.00	350 GMF350	- GBox: ZF S5-36
				3565.20.00	350 GMF350	- GBox: ZF S5-36
				3563.30.00	350 10 350GSZ	- GBox: ZF S5-36
				3521.20.00	350 GF350KR	

F 1900

FA 1900 DNT, FA 1900 NT, 16t	12.86 - 09.93	DNT 620		3500.90.05	350 10	
FA 1900 DNT, FD 1900 DNT, FD 1900 NT	12.86 - 09.93	NT 133		3573.20.00	MF350	
				3563.30.00	350GSZ	
				6905.40.00	KZIS - 3	
FA 1900 DNS	12.86 - 09.93	DNS 620		3500.90.39	350 10	
FA 1900 DNS, FA 1900 NS	12.86 - 09.93	DNT 620		3573.20.00	MF350	
FA 1900 DNT, FA 1900 NT, 18t	12.86 - 09.93	NS 156		3564.30.00	350GSZ	
FAV 1900 DNT, FAV 1900 NT	12.86 - 09.93	NT 133		8505.40.00	KZI - 4,5	
FT 1900 DNS, FT 1900 NS	12.86 - 09.93					

Vehicle list



DAF

F 2000

F 2000				3521.20.00	350 GF350KR	- GBox: S 8-45-2
F 2000 DH				3583.30.00	350 10 350GSZ	- GBox: S 8-45-2
F 2000 DHB		DHB 825		3829.20.00	380 GF380KR	
FA 2000 DHB	01.70 - 12.79			3852.30.00	380 10 380GS	
FAS 2000 DHB	01.70 - 12.79					
FAT 2000 DHB	01.70 - 12.79					
FM 2000 DHB	01.70 - 12.79					
FT 2000 DHB	01.70 - 12.79					
FT 2005 DHB	01.70 - 12.79					
FA 2000 DH	01.70 - 12.79	DH 825		3521.20.00	350 GF350KR	- GBox: S 8-45-2
FAS 2000 DH	01.70 - 12.79			3583.30.00	350 10 350GSZ	- GBox: S 8-45-2
FAT 2000 DH	01.70 - 12.79					
FM 2000 DH	01.70 - 12.79					
FT 2000 DH	01.70 - 12.79					

F 2100

F 2100				3160.20.00	310 MF310	
				3563.20.00	350 GMF350	
				3565.20.00	350 GMF350	
				3563.30.00	350 10 350GSZ	
				3879.20.00	380 GMF380	
				3852.30.00	380 10 380GS	
				8505.40.00	KZI - 4,5	
				3800.90.52	380 10 GMF380	- GBox: ZF S6-90/ZF 9/16S-109
				3878.20.00	380GSZ	
				3897.30.00	KZIS - 4	
				7951.40.00		
F 2105				3160.20.00	310 MF310	
				3563.20.00	350 GMF350	
				3565.20.00	350 GMF350	
				3563.30.00	350 10 350GSZ	
				3879.20.00	380 GMF380	
				3852.30.00	380 10 380GS	
				8505.40.00	KZI - 4,5	
				3800.90.52	380 10 GMF380	- GBox: ZF S6-90 / ZF9/16S-109
				3878.20.00	380GSZ	
				3897.30.00	KZIS - 4	
				7951.40.00		

Vehicle list

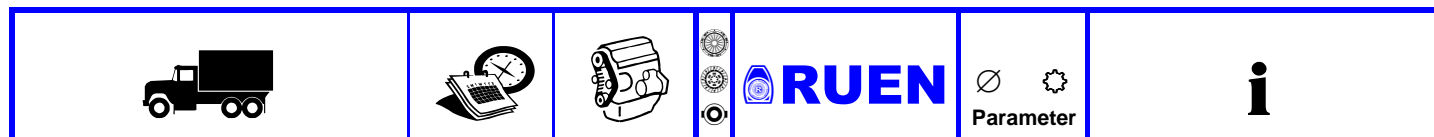

DAF

F 2100

FA 2100 DF,FA 2105 DF	07.78 - 09.86	DF 615		3800.90.52	380 10	- GBox: ZF 9/16S-109, S6-90
FA 2105 DHR,FA 2105 DHTD	07.78 - 09.86	DH 825		3878.20.00	GMF380	
FA 2105 DHT	07.81 - 09.86	DHR 825		3897.30.00	380GSZ	
	06.86 - 08.91	DHT 825		7951.40.00	KZIS - 4	
FA 2105 DHTD	06.86 - 08.91	DHTD 825				
FAG 2100 DH,FAG 2105 DH	07.78 - 09.86					
FAG 2100 DHR,FAG 2105 DHR,FAG 2100 DHTD	07.78 - 09.86					
FAS 2100 DHR,FAS 2103 DHR,FAS 2105 DHR,FAS 2103 DHTD	07.78 - 09.86					
FAS 2103 DH	07.78 - 09.86					
FAS 2103 DH,FAS 2105 DH	06.86 - 08.91					
FAS 2103 DHT, 162kW	07.81 - 09.86					
FAS 2103 DHT, 167kW	07.81 - 09.86					
FAS 2103 DHTD	06.86 - 08.91					
FT 2100 DHR	07.78 - 08.91					
FT 2105 DHT, 16t	07.81 - 09.86					
FT 2105 DHT, 17t	07.81 - 09.86					
FT 2105 DHTD, 16t	07.81 - 09.86					
FT 2105 DHTD	07.81 - 09.86					
FA 2100 DH	07.78 - 09.86	DH 825		3581.20.00	350	- GBox: S 6-36+GV 36
FA 2105 DH	06.86 - 08.91			3583.30.00	350 10	- GBox: S 6-36+GV 36
FT 2100 DH,FT 2105 DH	07.78 - 08.91			8514.40.00	350GSZ	- GBox: S 6-36+GV 36
				8514.40.00	KZI - 4,5	- GBox: S 6-36+GV 36
				3800.90.52	380 10	- GBox: ZF S6-90 / ZF9/16S-109
				3878.20.00	GMF380	
				3897.30.00	380GSZ	
				7951.40.00	KZIS - 4	
FA 2100 DNS				3800.90.52	380 10	- GBox: ZF S6-90 / ZF9/16S-109
				3878.20.00	GMF380	
				3897.30.00	380GSZ	
				7951.40.00	KZIS - 4	
				3500.90.39	350 10	- GBox: S 6-65+GV 80
				3573.20.00	MF350	
				3564.30.00	350GSZ	
				8505.40.00	KZI - 4,5	

F 2200

F 2200 DT				3521.20.00	350	- GBox: S 8-45-2
				3583.30.00	GF350KR	- GBox: S 8-45-2
				3583.30.00	350 10	- GBox: S 8-45-2
				3583.30.00	350GSZ	
F 2205 DHB		DU 825		3829.20.00	380	
FA 2200 DU	01.71 - 11.80			3829.20.00	GF380KR	
FAD 2205 DU	01.71 - 11.80			3852.30.00	380 10	
FAS 2200 DU				3852.30.00	380GS	
FAS 2205 DU	01.71 - 11.80					
FAT 2205 DU	01.71 - 11.80					
FAZ 2205 DU	01.71 - 11.80					
FT 2200 DU	01.71 - 11.80					

Vehicle list









DAF

F 2300 09.63 - 10.93





F 2300				3563.20.00	350 GMF350	
				3565.20.00	350 GMF350	
				3583.30.00	350 10 350GSZ	
				3852.30.00	380 10 380GS	
				3879.20.00	380 GMF380	
				7951.40.00	KZIS - 4	
					3800.90.52	380 10 GMF380 380GSZ KZIS - 4
F 2305				3563.20.00	350 GMF350	
				3565.20.00	350 GMF350	
				3583.30.00	350 10 350GSZ	
				3852.30.00	380 10 380GS	
				3879.20.00	380 GMF380	
				7951.40.00	KZIS - 4	
					3800.90.52	380 10 GMF380 380GSZ KZIS - 4
FA 2300 DHR FA 2300 DHU FA 2300 HT FAB 2305 DHT,FAG 2305 DHT,FAS 2300 DHU,FAS 2303 DHU,FAS 2305 FAG 2300 DHT,FAG 2305 DHT, 162 - 167kW FAG 2300 DHT,FAG 2305 DHT, 162kW FAG 2300 DHTD,FAG 2305 DHTD FAG 2300 HT,FAR 2300 HT FAG 2305 DH FAS 2300 DHR,FAS 2305 DHR FAT 2300 HT FAT 2305 DH FAT 2305 DHR FAT 2305 DHU,FAT 2335 DHT FAT 2335 DHT FAV 2300 HT FMB 2305 DHU FMT 2300 HT FMT 2305 DHR FMT 2305 DHU,FMT 2335 DHT FMT 2335 DHT FT 2300 DHU,FT 2305 DHU FT 2300 HT	07.78 - 12.81	DH 825		3800.90.52	380 10 GMF380 380GSZ KZIS - 4	- GBox: ZF 9S/16S-109, S6-90
	07.78 - 12.81	DHR 825		3878.20.00	GMF380	
	01.90 - 10.93	DHT 825		3897.30.00	380GSZ	
	07.78 - 09.86	DHTD 825		7951.40.00	KZIS - 4	
	11.81 - 09.86	DHU 825				
	09.86 - 08.91	HT 825				
	06.86 - 08.91					
	01.90 - 10.93					
	07.78 - 12.81					
	07.78 - 12.81					
	01.90 - 10.93					
	07.78 - 12.81					
	07.78 - 12.81					
	07.78 - 09.86					
	06.86 - 08.91					
	01.90 - 10.93					
	07.78 - 12.83					
	01.90 - 10.93					
	07.78 - 12.81					
	07.78 - 09.86					
06.86 - 08.91						
07.78 - 12.83						
01.90 - 10.93						

Vehicle list

					
---	---	---	--	---	---







DAF

F 2500

FA 2500 DHS		DHS 825	 3879.20.00	380 GMF380	- GBox: S 6-90+GV 90
FAD 2535 DHS, 184kW, 30t, Platform/Chassis	02.82 - 09.86		 8514.40.00	KZI - 4,5	- GBox: S 6-90+GV 90
FAD 2535 DHS, 184 - 195kW, 32t, Platform/Chassis	06.86 - 08.91				
FAD 2535 DHS, 194 - 195kW, 30t, Dump Truck	02.82 - 09.86				
FAD 2535 DHS, 194 - 195kW, 32t, Dump Truck	06.86 - 08.91				
FAS 2500 DHS					
FT 2500 DHS	02.82 - 09.86				
FA 2500 DHS	02.82 - 08.86	DHS 825	 3879.20.00	380 GMF380	
FA 2505 DHS	06.86 - 08.91				
FAG 2500 DHS,FAG 2505 DHS,FAS 2503 DHS	06.86 - 08.91		 8514.40.00	KZI - 4,5	
FAG 2505 DHS,FAS 2503 DHS	02.82 - 09.86				
FAT 2525 DHS, 22t	02.82 - 09.86				
FAT 2525 DHS, 24t	06.86 - 08.91				
FAT 2525 DHS,FAT 2535 DHS	06.86 - 08.91				
FAT 2535 DHS	02.82 - 09.86				
FMD 2525 DHS	02.82 - 09.86				
FMD 2525 DHS,FMD 2535 DHS	06.86 - 08.91				
FMT 2525 DHS	02.82 - 09.86				
FMT 2525 DHS,FMT 2535 DHS	06.86 - 08.91				
FT 2505 DHS	06.86 - 08.91				









F 2600

09.62 - 12.73

F 2600			 4205.20.00	420 G420KR	
FAT 2600 DKA			 4208.30.00	420 10 420GS	
FTT 2606 DKA (Iran)			 8514.40.00	KZI - 4,5	
FA 2600 DKB	02.72 - 12.73	DKB 1160	 4201.20.00	420 G420KR	
FAS 2600 DKB	02.72 - 12.73				
FT 2600 DKB	02.72 - 12.73		 4255.30.00	420 10 420GS	
FTS 2600 DKB					
FTT 2600 DKB	02.72 - 12.73		 8514.40.00	KZI - 4,5	

F 2700

01.90 - 10.93



























F 2700			 3800.90.52	380 10 GMF380	- GBox: ZF S6-90 / ZF9/16S-109
			 3878.20.00	380GSZ	
			 3897.30.00	KZIS - 4	
			 7951.40.00		
FA 2700 HS	01.90 - 10.93	HS 825	 3800.90.52	380 10 GMF380	
FAB 2700 HS,FAG 2700 HS,FAR 2700 HS	01.90 - 10.93				
FAT 2700 HS	01.90 - 10.93		 3878.20.00	380GSZ	
FMT 2700 HS	01.90 - 10.93		 3897.30.00	KZIS - 4	
FT 2700 HS	01.90 - 10.93		 7951.40.00		

Vehicle list

					
---	---	---	--	---	---

DAF

F 2800 09.73 - 09.91

F 2800 F 2805		4255.30.00	420 10 420GS	
		8514.40.00	KZI - 4,5	
		4256.20.00	420 GMF420K	- GBox: ZF 16S-151/181/221
		4287.30.00	420 10 420GVZ	- GBox: ZF 16S-151/181/221
		9101.40.00	KZI - 5	- GBox: ZF 16S-151/181/221
		4257.20.00	420 GMF420K	- GBox: ZF 16S-130
		4244.30.00	420 10 420/210GSZ	- GBox: ZF 16S-130
		7951.40.00	KZIS - 4	- GBox: ZF 16S-130
F 2800 ATi		4200.90.77	420 10 GMF420K	
		4256.20.00	420/210GSZ	
		4244.30.00	KZI - 4,5	
		8505.40.00		
		4256.20.00	420 GMF420K	- GBox: ZF 16S-151/181/221 - GBox: ZF 16S-130
		4278.30.00	420 10 420W2GSZ	- GBox: ZF 16S-151/181/221
		9101.40.00	KZI - 5	- GBox: ZF 16S-151/181/221
F 2800 DKA/DKT		4244.30.00	420 10 420/210GSZ	- GBox: ZF 16S-130
		7951.40.00	KZIS - 4	- GBox: ZF 16S-130
		4234.20.00	420 GF420KR	
		4222.20.00	420 GF420KR	
		4255.30.00	420 10 420GS	
		8514.40.00	KZI - 4,5	
		4256.20.00	420 GMF420K	- GBox: ZF 16S-151/181/221
		4287.30.00	420 10 420GVZ	- GBox: ZF 16S-151/181/221
		9101.40.00	KZI - 5	- GBox: ZF 16S-151/181/221
		4257.20.00	420 GMF420K	- GBox: ZF 16S-130
	4244.30.00	420 10 420/210GSZ	- GBox: ZF 16S-130	
	7951.40.00	KZIS - 4	- GBox: ZF 16S-130	

Vehicle list

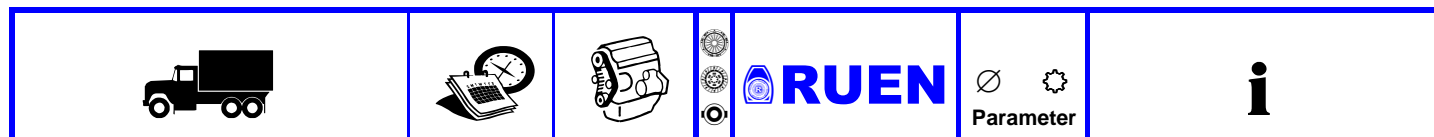

DAF

F 2800		09.73 - 09.91			
FA 2800 DKA	01.74 - 08.80	DKA 1160	4200.90.78	420 10	- GBox: ZF 16S-151/181/221
FA 2800 DKS	01.74 - 09.86	DKS 1160	4256.20.00	GMF420K	
FA 2800 DKT	01.74 - 11.80	DKS 1160 E	4287.30.00	420GVZ	
FA 2800 DKTD, 16t	01.74 - 09.86	DKT 1160	8505.40.00	KZI - 4,5	
FA 2800 DKTD, 17t	06.86 - 09.91	DKTD 1160			
FA 2805 DKSE,FA 2800 DKV,FA 2800 DKXE	05.83 - 09.91	DKV 1160			
FAB 2805 DKS,FAR 2800 DKS,FAS 2800 DKS	01.74 - 09.86	DKXE 1160			
FAB 2805 DKTD,FAS 2800 DKTD	01.74 - 09.86				
FAC 2803 DKS	01.74 - 09.86				
FAC 2803 DKSE	01.80 - 07.90				
FAC 2803 DKTD	01.74 - 09.91				
FAD 2805 DKS	01.74 - 09.86				
FAD 2805 DKTD	01.74 - 06.86				
FAD 2825 DKTD, Platform/Chassis	06.86 - 09.91				
FAD 2825 DKTD, Dump Truck	01.74 - 09.91				
FAD 2825 DKV	05.83 - 09.91				
FAG 2800 DKV,FAR 2804 DKXE,FAS 2803 DKXE,DKSE,DKV	05.83 - 09.91				
FAR 2804 DKSE,FAS 2800 DKT	01.80 - 09.86				
FAS 2800 DKA	01.74 - 11.80				
FAS 2803 DKS	06.86 - 09.91				
FAS 2803 DKTD	06.86 - 09.91				
FAT 2800 DKA	01.74 - 11.80				
FAT 2800 DKS	01.74 - 09.86				
FAT 2800 DKT	01.74 - 11.80				
FAT 2800 DKTD	01.74 - 09.86				
FAT 2805 DKS,FAT 2825 DKS	06.86 - 09.91				
FAT 2805 DKTD,FAT 2825 DKTD	06.86 - 09.91				
FMD 2805 DKTD,FMD 2825 DKTD, 30t	01.74 - 09.86				
FMD 2805 DKTD,FMD 2825 DKTD, 32t	06.86 - 09.91				
FMD 2825 DKV	05.83 - 09.91				
FT 2800 DKA	01.74 - 11.80				
FT 2800 DKT	01.74 - 11.80				
FT 2800 DKTD	01.74 - 09.86				
FT 2805 DKTD	06.86 - 09.91				
FTS 2800 DKA	01.74 - 11.80				
FTS 2800 DKS	01.74 - 09.86				
FTS 2800 DKT	01.74 - 11.80				
FTS 2800 DKTD	01.74 - 09.86				
FTS 2803 DKS	06.86 - 09.91				
FTS 2803 DKTD	06.86 - 09.91				
FTT 2800 DKA	01.74 - 11.80				
FTT 2800 DKS	01.74 - 09.86				
FTT 2800 DKT	01.74 - 11.80				
FTT 2800 DKTD	01.74 - 09.86				
FTT 2805 DKS,FTT 2815 DKS,FTT2825 DKS	06.86 - 09.91				
FTT 2805 DKTD	06.86 - 09.91				
FA 2800 DKSE	01.80 - 09.86	DKS 1160 E	4200.90.22	420 10	
FL 2805 DKS			4248.20.00	GFX420KR	
FT 2800 DKTD			4244.30.00	420/210GSZ	
			8514.40.00	KZI - 4,5	

Vehicle list

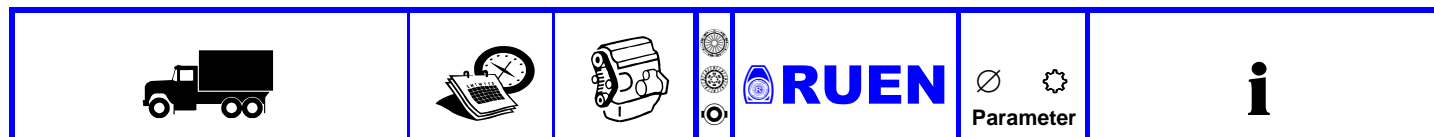

DAF

F 2800 09.73 - 09.91

FTT 2816 DKS				4256.20.00	420 GMF420K	- GBox: ZF 16S-151/181/221
				4287.30.00	420 10 420GVZ	- GBox: ZF 16S-151/181/221
				9101.40.00	KZI - 5	- GBox: ZF 16S-151/181/221
				4257.20.00	420 GMF420K	- GBox: ZF 16S-130
				4244.30.00	420 10 420/210GSZ	- GBox: ZF 16S-130
				7951.40.00	KZIS - 4	- GBox: ZF 16S-130
FT 2800 DKS FT 2800 DKSE, FT 2800DKXE, FT 2800 DKV FT 2805 DKS	01.74 - 09.86	DKS 1160		4200.90.22	420 10	
				4248.20.00	GFX420KR	
	01.80 - 09.91	DKS 1160 E		4244.30.00	420/210GSZ	
				8514.40.00	KZI - 4,5	
	06.86 - 09.91	DKV 1160 DKXE 1160		4256.20.00	420 GMF420K	- GBox: ZF 16S-151/181/221
				4287.30.00	420 10 420GVZ	- GBox: ZF 16S-151/181/221
				9101.40.00	KZI - 5	- GBox: ZF 16S-151/181/221
				4257.20.00	420 GMF420K	- GBox: ZF 16S-130
			4244.30.00	420 10 420/210GSZ	- GBox: ZF 16S-130	
			7951.40.00	KZIS - 4	- GBox: ZF 16S-130	

F 2900 01.90 - 10.93

FA 2900 KV FAD 2900 KV FAG 2900 KV, FAR 2900 KV, FAS 2900 KV FMD 2900 KV FT 2900 KV	01.90 - 10.93	KV 1160		4200.90.78	420 10	- GBox: ZF 16S-151/181/221
				4256.20.00	GMF420K	
				4287.30.00	420GVZ	
				8505.40.00	KZI - 4,5	

F 3200 01.90 - 10.93

FA 3200 KS FAB 3200 KS, FAR 3200 KS, FAS 3200 KS FAD 3200 KS FAT 3200 KV FMD 3200 KS FT 3200 KS	01.90 - 10.93	KS 1160		4200.90.78	420 10	- GBox: ZF 16S-151/181/221
				4256.20.00	GMF420K	
				4287.30.00	420GVZ	
				8505.40.00	KZI - 4,5	

F 3300 06.81 - 09.91

F 3300				4248.30.00	420 10 420W2GSZ	
				4210.30.00	420 10 420/210GSZ	
				8514.40.00	KZI - 4,5	
				4256.20.00	420 GMF420K	- GBox: ZF 16S-151/181/221
				4287.30.00	420 10 420GVZ	- GBox: ZF 16S-151/181/221
				9101.40.00	KZI - 5	- GBox: ZF 16S-151/181/221
				4257.20.00	420 GMF420K	- GBox: ZF 16S-130
				4244.30.00	420 10 420/210GSZ	- GBox: ZF 16S-130
				7951.40.00	KZIS - 4	- GBox: ZF 16S-130

Vehicle list



DAF

F 3300 06.81 - 09.91

F 3300 ATi			4200.90.77 4256.20.00 4244.30.00 8505.40.00	420 10 GMF420K 420/210GSZ KZI - 4,5	
			4256.20.00	420 GMF420K	- GBox: ZF 16S-151/181/221
			4287.30.00	420 10 420GVZ	- GBox: ZF 16S-151/181/221
			9101.40.00	KZI - 5	- GBox: ZF 16S-151/181/221
			4257.20.00	420 GMF420K	- GBox: ZF 16S-130
			4244.30.00	420 10 420/210GSZ	- GBox: ZF 16S-130
			7951.40.00	KZIS - 4	- GBox: ZF 16S-130
FA 3300 DKX,FA 3305 DKX, 243kW	06.81 - 09.86	DKX 1160	4200.90.78 4256.20.00 4287.30.00 8505.40.00	420 10 GMF420K 420GVZ KZI - 4,5	- GBox: ZF 16S-151/181/221
FA 3300 DKX,FA 3305 DKX, 260kW	06.85 - 09.91	DKX 1160 ATi			
FAB 3305 DKX,FAG 3300 DKX,FAR 3300 DKX,FAS 3303 DKX	06.81 - 09.86				
FAC 3303 DKX, 243kW	06.81 - 09.86				
FAC 3303 DKX, 260kW	06.85 - 09.91				
FAD 3325 DKX, 243kW	06.81 - 09.86				
FAD 3325 DKX, 260kW	06.85 - 09.91				
FAG 3300 DKX,FAR 3304 DKX,FAS 3303 DKX	06.85 - 09.91				
FAT 3325 DKX, 243kW	06.81 - 09.86				
FAT 3325 DKX, 260kW	09.85 - 09.91				
FT 3305 DKX, 243kW	06.81 - 09.86				
FT 3305 DKX, 260kW	06.85 - 09.91				
FTG 3300 DKX,FTS 3300 DKX	06.81 - 09.86				
FTG 3300 DKX,FTS 3303 DKX	06.85 - 09.91				
FTT 3325 DKX, 243kW	06.81 - 09.86				
FTT 3325 DKX, 260kW	06.85 - 09.91				

F 3600 06.85 - 09.91

F 3600			4200.90.78 4256.20.00 4287.30.00 8505.40.00	420 10 GMF420K 420GVZ KZI - 4,5	
			4256.20.00	420 GMF420K	- GBox: ZF 16S-151/181/221
			4287.30.00	420 10 420GVZ	- GBox: ZF 16S-151/181/221
			9101.40.00	KZI - 5	- GBox: ZF 16S-151/181/221
			4257.20.00	420 GMF420K	- GBox: ZF 16S-130
			4244.30.00	420 10 420/210GSZ	- GBox: ZF 16S-130
			7951.40.00	KZIS - 4	- GBox: ZF 16S-130
FA 3605 DKZ	06.85 - 09.91	DKZ 1160 ATi	4200.90.78 4256.20.00 4287.30.00 8505.40.00	420 10 GMF420K 420GVZ KZI - 4,5	- GBox: ZF 16S-151/181/221
FA 3605 DKZE	06.85 - 09.91	DKZE 1160			
FAC 3603 DKZ	06.85 - 09.91				
FAG 3600 DKZ,FAR 3604 DKZ,FAS 3603 DKZ	06.85 - 09.91				
FAR 3604 DKZE,FAS 3603 DKZE	06.85 - 09.91				
FT 3605 DKZ	06.85 - 09.91				
FT 3605 DKZE	06.85 - 09.91				
FTG 3600 DKZ,FTS 3603 DKZ	06.85 - 09.91				
FTT 3625 DKZ	06.85 - 09.91				

Vehicle list



DAF

N 2800

NAT 2826 DKS	01.81 - 09.91	DKS 1160		4257.20.00	420 GMF420K	
				4244.30.00	420 10 420/210GSZ	

N 3300

NAT 3326 DKX	01.81 - 09.91	DKX 1160		4257.20.00	420 GMF420K	- GBox: ZF 16S-130
				4210.30.00	420 10 420/210GSZ	
				8514.40.00	KZI - 4,5	
				4256.20.00	420 GMF420K	- GBox: ZF 16S-151/181/221
				4278.30.00	420 10 420W2GSZ	- GBox: ZF 16S-151/181/221
				9101.40.00	KZI - 5	- GBox: ZF 16S-151/181/221
				4244.30.00	420 10 420/210GSZ	- GBox: ZF 16S-130
				7951.40.00	KZIS - 4	- GBox: ZF 16S-130







T - Series

T 15/2 DF T 1600 DF				3107.20.00	310 GF310K	
T 18 DM TB 160/163 DS				3521.20.00	350 GF350KR	- GBox: AK/S 5-35-2
				3563.30.00	350 10 350GSZ	- GBox: AK/S 5-35-2
T 500 T 505				3573.20.00	350 MF350	
				3563.30.00	350 10 350GSZ	
T 2200 DKD				4205.20.00	420 G420KR	
				4208.30.00	420 10 420GS	
				8514.40.00	KZI - 4,5	
T 2400 DK TE 2400 DK				4205.20.00	420 G420KR	
				4208.30.00	420 10 420GS	
				8514.40.00	KZI - 4,5	
TT 1303 DH				3581.20.00	350 GMF350KR	- GBox: 4-WG 181
				3580.20.00	350 GMF350	- GBox: 4-WG 181
				3583.30.00	350 10 350GSZ	- GBox: 4-WG 181
				8514.40.00	KZI - 4,5	- GBox: 4-WG 181
T 510 T 520				4341.20.00	430 MFZ430	
				4244.30.00	420 10 420/210GSZ	
T 575				4341.20.00	430 MFZ430	

V



V 1600 DD V 1700 DF V 1700 DSD				3521.20.00	350 GF350KR	- GBox: AK/S 5-35-2
				3563.30.00	350 10 350GSZ	- GBox: AK/S 5-35-2

Vehicle list









					
---	---	---	--	---	---

DAF























V

V 2400 DK VE 2400 DK			 4205.20.00	420 G420KR	
			 4208.30.00	420 10 420GS	
			 8514.40.00	KZI - 4,5	

LF 05.13 -

FA 220	05.13 - 05.13 -		 3953.20.00	395 MF395	
FA 250, 187kW FA 250 FA 280 FA 310	05.13 - 05.13 - 05.13 - 05.13 -		 8542.40.00	KZIS-4	
FA 150 FA 180 FA 210	05.13 - 05.13 - 05.13 -		 3500.90.53  35173.20.00  35101.30.00  8541.40.00	350 MF350 350WGTZ KZIS-4	- Engine code: PX-5 112 - GBox: S5-42
			 3617.20.00	362 MF362	
			 8542.40.00	KZIS-4	

LF 45 01.01 -

FA 45.150, 7.49t FA 45.150, 10t FA 45.150, 12t FA 45.170, 7.49t FA 45.170, 10t FA 45.170, 12t FA 45.180, 7.49t FA 45.180, 10t FA 45.180, 12t FA 45.220, 7.49t FA 45.220, 10t FA 45.220, 12t	01.01 - 01.01 - 01.01 - 01.01 - 01.01 - 01.01 - 01.01 - 01.01 - 01.01 - 01.01 - 01.01 - 01.01 -	BE 110 C BE 123 C CE 136 C CE 162 C	 3620.90.03  3607.20.00  3607.30.00  8541.40.00	362 10 MF362 362WGTZ KZIS-4	- GBox: ZF 5S-42
			 3950.90.07  3953.20.00  3952.30.00  7951.40.00	395 10 MF395 395WGTZ KZIS - 4	- GBox: ZF 6S-850
45.170		BE 123 C	 3620.90.05  3607.20.00  3607.30.00  7951.40.00	362 10 MF362 362WGTZ KZIS - 4	- GBox: ZF5S-42
FA 45.220 FA 45.250	05.06 - 03.06 -		 3950.90.06  3953.20.00  3953.30.00  8542.40.00	395 10 MF395 395WGTZ KZIS-4	- GBox: ZF
			 3953.20.00	395 MF395	
			 8542.40.00	KZIS-4	
			 7951.40.00	KZIS - 4	
FA 45.140 FA 45.160 FA 45.180	05.06 - 05.06 - 05.06 -		 3620.90.07  3607.20.00  3609.30.00  8542.40.00	362 10 MF362 362 WGTZ KZIS-4	

Vehicle list



DAF







LF 55 01.01 -

55.170		BE 123 C	3620.90.05 3607.20.00 3607.30.00 7951.40.00	362 10 MF362 362WGTZ KZIS - 4	- GBox: ZF 6S-850
FA 55.170	01.01 -	BE 123 C	3950.90.07 3953.20.00 3952.30.00 7951.40.00	395 10 MF395 395WGTZ KZIS - 4	- GBox: ZF 6S-850
FA 55.180, 13t	01.01 -	CE 136 C			
FA 55.180, 15t	01.01 -	CE 162 C	3950.90.09 3953.20.00 3954.30.00 7951.40.00	395 10 MF395 395WGTZ KZIS - 4	- GBox: Eaton 6309
FA 55.180, 18t	01.01 -	CE 184 C			
FA 55.220, 13t	01.01 -		3620.90.07 3607.20.00 3609.30.00 8542.40.00	362 10 MF362 362 WGTZ KZIS-4	
FA 55.220, 18t	01.01 -				
FA 55.250, 15t	01.01 -		3950.90.06 3953.20.00 3953.30.00 8542.40.00	395 10 MF395 395WGTZ KZIS-4	
FA 55.250, 18t	01.01 -				
FA 55.180	05.06 -		3953.20.00 8542.40.00	395 MF395	- GBox: ZF 6S/800, 6S/1000
FA 55.220	05.06 -				
FA 55.250	05.06 -		7951.40.00	KZIS-4	- GBox: Eaton
FAN 55.220	05.06 -				
FAN 55.250	05.06 -		3950.90.06 3953.20.00 3953.30.00 8542.40.00	395 10 MF395 395WGTZ KZIS-4	
FT 55.220, 13t	01.01 -				
FT 55.250	01.01 -		3953.20.00 7951.40.00	395 MF395	- GBox: ZF 6S/800, 6S/1000
FA 55.280	05.06 -				
FA 55.290	05.06 -		7951.40.00	KZIS - 4	- GBox: Eaton
FAN 55.290	05.06 -				
FT 55.280	05.06 -		3620.90.08 3607.20.00 3610.30.00 7951.40.00	362 10 MF362 362GTZ KZIS - 4	- GBox: 6S850
FT 55.290	05.06 -				
FAN 55.250	05.06 -		3620.90.06 3607.20.00 3610.30.00 6905.40.00	362 10 MF362 362GTZ KZIS - 3	- GBox: ZF 6S-36
			3573.20.00	350 MF350	- GBox: ZF 6S-36 - GBox: ZF 9S-75
			3564.30.00	350 10 350GSZ	- GBox: ZF 6S-36 - GBox: ZF 9S-75
			6905.40.00	KZIS - 3	- GBox: ZF 9S-75 - GBox: ZF 6S-36
			3607.20.00	362 MF362	- GBox: ZF 9S-75
			3611.30.00	362 10 362GTZ	- GBox: ZF 9S-75
			7951.40.00	KZIS - 4	- GBox: ZF 9S-75

65 01.93 - 02.98















FA 65.180	03.93 - 02.98	NS 133 L	3620.90.08 3607.20.00 3610.30.00 7951.40.00	362 10 MF362 362GTZ KZIS - 4	- GBox: 6S850
FA 65.210	03.93 - 02.98	NS 133 M			
FA 65.240	03.93 - 02.98	NS 156 L	3620.90.06 3607.20.00 3610.30.00 6905.40.00	362 10 MF362 362GTZ KZIS - 3	- GBox: ZF 6S-36
FAV 65.180	03.93 - 02.98	NS 156 M			
FAV 65.210	03.93 - 02.98	NS 177 M	3573.20.00	350 MF350	- GBox: ZF 6S-36 - GBox: ZF 9S-75
			3564.30.00	350 10 350GSZ	- GBox: ZF 6S-36 - GBox: ZF 9S-75
			6905.40.00	KZIS - 3	- GBox: ZF 9S-75 - GBox: ZF 6S-36
			3607.20.00	362 MF362	- GBox: ZF 9S-75
			3611.30.00	362 10 362GTZ	- GBox: ZF 9S-75
			7951.40.00	KZIS - 4	- GBox: ZF 9S-75

Vehicle list



























					
---	---	---	--	---	---

DAF





65 CF 02.98 - 12.00

FA 65 CF 180	02.98 - 12.00	NS 133 M	 3620.90.08	362 10	
FA 65 CF 210	02.98 - 12.00	NS 156 M	 3607.20.00	MF362	
FA 65 CF 240	02.98 - 12.00	NS 177 M	 3610.30.00	362GTZ	
FAV 65 CF 180	02.98 - 12.00		 7951.40.00	KZIS - 4	
FAV 65 CF 210	02.98 - 12.00				
FAV 65 CF 240	02.98 - 12.00	NS 177 M	 4200.90.81	420 10	
			 4257.20.00	GMF420K	
			 4244.30.00	420/210GSZ	
			 7951.40.00	KZIS - 4	
			 4300.90.181 	430 10	- GBox: 8/16S151 - Only install together
			 43100.20.00	MFZ430E	
			 4334.30.00	430GTZ	
			 8916.40.00	KZIZ - 5	
			 4334.30.00	430 10	- For PTO
				430GTZ	
			 8950.40.00	KZIZ-6	- For PTO

CF 65 01.01 -

FA 65.180	01.01 -	CE 136 C	 3950.90.07	395 10	- GBox: ZF 6S-850
FA 65.220	01.01 - 05.13	CE 162 C	 3953.20.00	MF395	
FA 65.250	01.01 - 05.13	CE 184 C	 3952.30.00	395WGTZ	
			 7951.40.00	KZIS - 4	
			 3950.90.08	395 10	- GBox: Eaton 6309
			 3953.20.00	MF395	
			 3953.30.00	395WGTZ	
			 7951.40.00	KZIS - 4	
FA 65.180	01.01 - 05.13		 3950.90.07	395 10	- GBox: ZF-6S-850 - Engine code: CE 162 C
FA 65.220	05.06 - 05.13		 3953.20.00	MF395	
			 3952.30.00	395WGTZ	
			 7951.40.00	KZIS - 4	
			 3950.90.08	395 10	- GBox: Eaton 6309
			 3953.20.00	MF395	
			 3953.30.00	395WGTZ	
			 7951.40.00	KZIS - 4	
FA 65.250	05.06 - 05.13		 3950.90.06	395 10	
			 3953.20.00	MF395	
			 3953.30.00	395WGTZ	
			 8542.40.00	KZIS-4	
			 3953.20.00	395	- GBox: ZF
				MF395	
			 8542.40.00	KZIS-4	
FA 65.280	05.06 - 05.13		 3950.90.06	395 10	- GBox: ZF
			 3953.20.00	MF395	
			 3953.30.00	395WGTZ	
			 8542.40.00	KZIS-4	

75 07.92 - 02.98

FA 75.240	07.92 - 02.98	RS 180	 3800.90.52	380 10	
FAG 75.240,FAN 75.240	07.92 - 02.98	RS 180 L	 3878.20.00	GMF380	
FAR 75.240,FAS 75.240	07.92 - 02.98	RS 180 M	 3897.30.00	380GSZ	
FAV 75.240	07.92 - 02.98		 7951.40.00	KZIS - 4	
FT 75.240	07.92 - 02.98				

Vehicle list



DAF

75 07.92 - 02.98

FA 75.270	07.92 - 02.98	RS 200	4200.90.81	420 10	
FA 75.300	07.92 - 02.98	RS 200 L	4257.20.00	GMF420K	
FAG 75.270,FAN 75.270	07.92 - 02.98	RS 200 M	4244.30.00	420/210GSZ	
FAG 75.300,FAN 75.300	07.92 - 02.98	RS 222	7951.40.00	KZIS - 4	
FAR 75.270,FAS 75.270	07.92 - 02.98	RS 222 L			
FAR 75.300,FAS 75.300	07.92 - 02.98	RS 222 M			
FAT 75.270	07.92 - 02.98				
FAV 75.270	07.92 - 02.98				
FT 75.270	07.92 - 02.98				
FT 75.300	07.92 - 02.98				

75 CF 02.98 - 12.00

FA 75 CF 250	02.98 - 12.00	PF 183 M	4200.90.81	420 10	
FA 75 CF 290	02.98 - 12.00	PF 212 M	4257.20.00	GMF420K	
FAG 75 CF 250,FAN 75 CF 250	02.98 - 12.00	PR 183 S	4244.30.00	420/210GSZ	
FAG 75 CF 290,FAN 75 CF 290	02.98 - 12.00		7951.40.00	KZIS - 4	
FAR 75 CF 250,FAS 75 CF 250	02.98 - 12.00		4300.90.181	430 10	- GBox: 8/16S151
FAR 75 CF 290,FAS 75 CF 290	02.98 - 12.00		43100.20.00	MFZ430E	- Only install together
FAT 75 CF 250	02.98 - 12.00		4334.30.00	430GTZ	
FAT 75 CF 290	02.98 - 12.00		8916.40.00	KZIZ - 5	
FAV 75 CF 250, 18t	06.01 -				
FA 75 CF 320	02.98 - 12.00	PF 235 M	4300.90.03	430 10	- GBox: 8/16S151
FAG 75 CF 320,FAN 75 CF 320	02.98 - 12.00		4301.20.00	MFZ430	
FAR 75 CF 320,FAS 75 CF 320	02.98 - 12.00		4334.30.00	430GTZ	
FAT 75 CF 320	02.98 - 12.00		8916.40.00	KZIZ - 5	
			4300.90.181	430 10	- GBox: 8/16S151
			43100.20.00	MFZ430E	- Only install together
			4334.30.00	430GTZ	
			8916.40.00	KZIZ - 5	
FT 75 CF 250	02.98 - 12.00	PF 183 M	4200.90.81	420 10	
FT 75 CF 290	02.98 - 12.00	PF 212 M	4257.20.00	GMF420K	
			4244.30.00	420/210GSZ	
			7951.40.00	KZIS - 4	
			4300.90.181	430 10	- Engine code: 8/16S151
			43100.20.00	MFZ430E	- Only install together
			4334.30.00	430GTZ	
			8916.40.00	KZIZ - 5	
FT 75 CF 320	02.98 - 12.00	PF 235 M	4300.90.03	430 10	- GBox: 8/16S151
			4301.20.00	MFZ430	
			4334.30.00	430GTZ	
			8916.40.00	KZIZ - 5	
			4300.90.181	430 10	- GBox: 8/16S151
			43100.20.00	MFZ430E	- Only install together
			4334.30.00	430GTZ	
			8916.40.00	KZIZ - 5	

Vehicle list

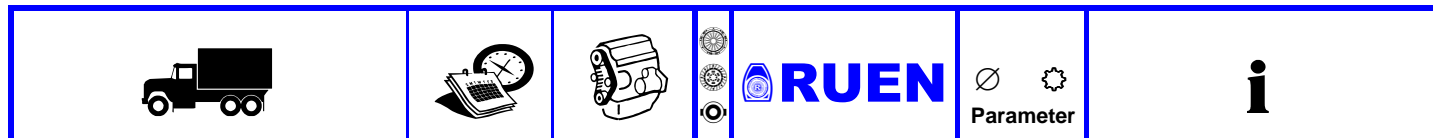

DAF

CF 75

01.01 -

FA 75.250	01.01 - 05.13	PE 183 C	4300.90.03	430 10	- GBox: 8S-151/16S-151
FA 75.310	01.01 - 05.13	PE 228 C	4301.20.00	MFZ430	
FAG 75.250, FAN 75.250, 26, 26.50t	01.01 - 05.13	PR 183 S	4334.30.00	430GTZ	
FAG 75.310, FAN 75.310, 26, 27t	01.01 - 05.13	PR 228 S	8916.40.00	KZIZ - 5	
FAR 75.250, FAS 75.250, 26, 26.50t	01.01 - 05.13		3950.90.08	395 10	- GBox: 9S-109 / 16S-109
FAT 75.250	01.01 - 05.13		3953.20.00	MF395	
FAT 75.310	01.01 - 05.13		3953.30.00	395WGTZ	
FT 75.250	01.01 - 05.13		7951.40.00	KZIS - 4	
FT 75.310	01.01 - 05.13		4300.90.181	430 10	- GBox: 8S-151/16S-151 - Only install together
			43100.20.00	MFZ430E	
			4334.30.00	430GTZ	
			8916.40.00	KZIZ - 5	
			4371.20.00	430 MFZ430	- GBox: ZF AS-Tronic
FAD 75.360	01.01 - 05.13		3950.90.08	395 10	- GBox: 9S-109/16S109
			3953.20.00	MF395	
			3953.30.00	395WGTZ	
			7951.40.00	KZIS - 4	
			4300.50.03	430 10	- Engine code: PR 265 S - GBox: Ecosplit 3
			4303.20.00	MFZ430	
			4334.30.00	430GTZ	
			4300.90.72	430 10	- Engine code: PR 265 S - GBox: Ecosplit 3
			4301.20.00	MFZ430	
			4338.30.00	430WGTZ	
			8916.40.00	KZIZ - 5	
			4300.90.89	430 10	- Engine code: PR 265 S - GBox: Ecosplit 4
			4301.20.00	MFZ430	
			4338.30.00	430WGTZ	
			8939.40.00	KZISZ - 5	
			4300.90.69	430 10	- Engine code: PR 265 S - GBox: AS Tronic
			4301.20.00	MFZ430	
			4332.30.00	430GTZ	
			8939.40.00	KZISZ - 5	
			4300.90.181	430 10	- GBox: Ecosplit 3 - Only install together
			43100.20.00	MFZ430E	
			4334.30.00	430GTZ	
			8916.40.00	KZIZ - 5	
			4300.90.188	430 10	- GBox: Ecosplit 3 - Only install together
			43100.20.00	MFZ430E	
			43134.30.00	430WGTZ	
			8916.40.00	KZIZ - 5	
			4300.90.189	430 10	- GBox: Ecosplit 4 - GBox: AS Tronic - Only install together
			43100.20.00	MFZ430E	
			43134.30.00	430WGTZ	
			8939.40.00	KZISZ - 5	
			4371.20.00	430 MFZ430	- GBox: ZF AS-Tronic

Vehicle list









DAF

CF 75 01.01 -

FAD 75.310	01.01 - 05.13		4300.50.03 4303.20.00 4334.30.00	430 10 MFZ430 430GTZ	- GBox: 8S-151/16S-151
			3950.90.08 3953.20.00 3953.30.00 7951.40.00	395 10 MF395 395WGTZ KZIS - 4	- Engine code: PR 228 S - GBox: 9S-109/16S109
			4300.90.69 4301.20.00 4332.30.00 8939.40.00	430 10 MFZ430 430GTZ KZISZ - 5	- Engine code: PR 228 S - GBox: ZF AS-Tronic
			4300.90.181 43100.20.00 4334.30.00 8916.40.00	430 10 MFZ430E 430GTZ KZIZ - 5	- GBox: 8S-151/16S-151 - Only install together
			4371.20.00	430 MFZ430	- GBox: ZF AS-Tronic
FA 75.250 FA 75.250, 9200cc FA 75.310 FA 75.360 FAD 75.250 FAT 75.250 FAT 75.310 FAT 75.360 FT 75.250 FT 75.310 FT 75.360	10.06 - 05.13 10.06 - 05.13 10.06 - 05.13 10.06 - 05.13 01.01 - 05.13 10.06 - 05.13 10.06 - 05.13 10.06 - 05.13 10.06 - 05.13 10.06 - 05.13 10.06 - 05.13	PE 265 C PR 183 S PR 228 S PR 265 S	4300.90.03 4301.20.00 4334.30.00 8916.40.00	430 10 MFZ430 430GTZ KZIZ - 5	- GBox: 8S-151/16S-151
			4300.90.181 43100.20.00 4334.30.00 8916.40.00	430 10 MFZ430E 430GTZ KZIZ - 5	- GBox: 8S-151/16S-151 - Only install together
			3950.90.08 3953.20.00 3953.30.00 7951.40.00	395 10 MF395 395WGTZ KZIS - 4	- GBox: 9S-109/16S109
			4300.90.69 4301.20.00 4332.30.00 8939.40.00	430 10 MFZ430 430GTZ KZISZ - 5	- GBox: ZF AS-Tronic - Use release fork with rollers
			4371.20.00	430 MFZ430	- GBox: ZF AS-Tronic











































Vehicle list

					
---	---	---	--	---	---







DAF

CF 75















































01.01 -

FA 75.360 FAG 75.360, FAN 75.360, 26, 27t FAR 75.360, FAS 75.360 FT 75.360	01.01 - 05.13 01.01 - 05.13 01.01 - 05.13 01.01 - 05.13	PE 265 C PR 265 S	 4300.90.03  4301.20.00  4334.30.00  8916.40.00	430 10 MFZ430 430GTZ KZIZ - 5	- GBox: 8S-151/16S-151
			 3950.90.08  3953.20.00  3953.30.00  7951.40.00	395 10 MF395 395WGTZ KZIS - 4	- GBox: 9S-109 / 16S-109
			 4300.90.181   43100.20.00  4334.30.00  8916.40.00	430 10 MFZ430E 430GTZ KZIZ - 5	- GBox: 8S-151/16S-151 - Only install together
			 4300.90.188   43100.20.00  43134.30.00  8916.40.00	430 10 MFZ430E 430WGTZ KZIZ - 5	- GBox: Ecosplit 3
			 4300.90.189   43100.20.00  43134.30.00  8939.40.00	430 10 MFZ430E 430WGTZ KZISZ - 5	- GBox: Ecosplit 4 - GBox: AS Tronic - Use release fork with rollers
			 4371.20.00	430 MFZ430	- GBox: ZF AS-Tronic
			 4300.90.171  4301.20.00  4338.30.00  8916.40.00	430 10 MFZ430 430WGTZ KZIZ - 5	- Transmission type: Ecosplit 3
			FAR 75.310, FAS 75.310, 26, 26.50t	01.01 - 05.13	PE 228 C PR 228 S
 3950.90.08  3953.20.00  3953.30.00  7951.40.00	395 10 MF395 395WGTZ KZIS - 4	- GBox: 9S-109 / 16S-109			
 4300.90.181   43100.20.00  4334.30.00  8916.40.00	430 10 MFZ430E 430GTZ KZIZ - 5	- GBox: 8S-151/16S-151 - Only install together			
 4300.90.189   43100.20.00  43134.30.00  8939.40.00	430 10 MFZ430E 430WGTZ KZISZ - 5	- GBox: Ecosplit 4 - GBox: AS Tronic - Use release fork with rollers			
 4371.20.00	430 MFZ430	- GBox: ZF AS-Tronic			

Vehicle list

					
---	---	---	--	---	---

DAF

CF 75						01.01 -					
FAT 75.360	01.01 - 05.13	PE 265 C PR 265 S		4300.90.03	430 10	- GBox: 8S-151/16S-151					
				 4301.20.00	MFZ430						
				 4334.30.00	430GTZ						
				 8916.40.00	KZIZ - 5						
					3950.90.08	395 10	- GBox: 9S-109 / 16S-109				
			 3953.20.00	MF395							
			 3953.30.00	395WGTZ							
			 7951.40.00	KZIS - 4							
				4300.90.181 	430 10	- GBox: 8S-151/16S-151 - Only install together					
			 43100.20.00	MFZ430E							
			 4334.30.00	430GTZ							
			 8916.40.00	KZIZ - 5							
				4300.90.189 	430 10	- GBox: Ecosplit 4 - GBox: AS Tronic - Use release fork with rollers					
			 43100.20.00	MFZ430E							
			 43134.30.00	430WGTZ							
			 8939.40.00	KZISZ - 5							
				4371.20.00	430	- GBox: ZF AS-Tronic					
				MFZ430							
85						07.92 - 02.98					
F 85.300	01.92 -	WS 242		4200.90.82	420 10						
FA 85.330	07.92 - 02.98	WS 242 L		 4256.20.00	GMF420K						
FA 85.360	07.92 - 02.98	WS 242 M		 4259.30.00	420GSZ						
FAD 85.330	07.92 - 02.98	WS 268		 9101.40.00	KZI - 5						
FAD 85.360	07.92 - 02.98	WS 268 L		4300.90.03	430 10						
FAG 85.360,FAR 85.360,FAS 85.360	07.92 - 02.98	WS 268 M		 4301.20.00	MFZ430						
FAT 85.360	07.92 - 02.98			 4334.30.00	430GTZ						
FAT 85.330	07.92 - 02.98			 8916.40.00	KZIZ - 5						
FA 85.400	03.95 - 02.98	WS 295 M		4300.90.03	430 10	- GBox: 816S-151/181/221					
FAD 85.400	03.95 - 02.98			 4301.20.00	MFZ430						
FAG 85.400,FAR 85.400,FAS 85.400	03.95 - 02.98			 4334.30.00	430GTZ						
FAT 85.400	03.95 - 02.98			 8916.40.00	KZIZ - 5						
FAG 85.330,FAR 85.330,FAS 85.330	07.92 - 02.98	WS 242 L WS 242 M		4200.90.22	420 10						
				 4248.20.00	GFX420KR						
				 4244.30.00	420/210GSZ						
				 8514.40.00	KZI - 4,5						
				4200.90.82	420 10						
				 4256.20.00	GMF420K						
				 4259.30.00	420GSZ						
				 9101.40.00	KZI - 5						
FT 85.330	07.92 - 02.98	WS 242		4200.90.82	420 10						
FT 85.360	07.92 - 02.98	WS 242 L		 4256.20.00	GMF420K						
FTG 85.330	07.92 - 02.98	WS 242 M		 4259.30.00	420GSZ						
FTG 85.360	07.92 - 02.98	WS 268 L		 9101.40.00	KZI - 5						
FTT 85.330	07.92 - 02.98	WS 268 M									
FTT 85.360	07.92 - 02.98										
FT 85.400	03.95 - 02.98	WS 295 M		4300.90.03	430 10	- GBox: 8/16S151/181/221					
FTG 85.400	03.95 - 02.98			 4301.20.00	MFZ430						
				 4334.30.00	430GTZ						
				 8916.40.00	KZIZ - 5						

Vehicle list

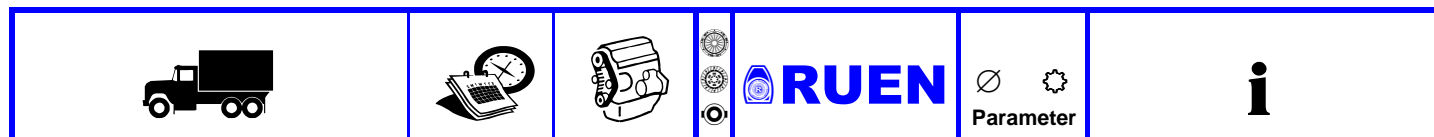

DAF

85 07.92 - 02.98

FTT 85.400	03.95 - 02.98	WS 295 M	4300.90.03	430 10	- GBox: 8/16S151/181/221
			4301.20.00	MFZ430	
			4334.30.00	430GTZ	
			8916.40.00	KZIZ - 5	
			4205.20.00	420	
			4208.30.00	420 10	
				420GS	
			8514.40.00	KZI - 4,5	

CF 05.13 -

CF 220	01.14 -		3953.20.00	395	
CF 250	01.14 -			MF395	
CF 280	01.14 -		8542.40.00	KZIS-4	
CF 310	01.14 -				
FA 400	05.13 -		4300.90.89	430 10	- Engine code: MX-11 210
FA 410	05.13 -		4301.20.00	MFZ430	- GBox: AS Tronic
FA 440, 320kW	05.13 -		4338.30.00	430WGTZ	
FA 460	05.13 -		8939.40.00	KZISZ - 5	
FA 510	05.13 -		4300.90.189	430 10	- GBox: AS Tronic
FAD 400	05.13 -		43100.20.00	MFZ430E	
FAD 410	05.13 -		43134.30.00	430WGTZ	
FAD 440	05.13 -		8939.40.00	KZISZ - 5	
FAD 460	05.13 -				
FAD 510	05.13 -				
FAN 400, FAG 400	05.13 -				
FAN 410, FAG 410	05.13 -				
FAN 440, FAG 440	05.13 -				
FAN 460, FAG 460	05.13 -				
FAN 510, FAG 510	05.13 -				
FAR 400, FAS 400	05.13 -				
FAR 410, FAS 410	05.13 -				
FAR 440, FAS 440	05.13 -				
FAR 460, FAS 460	05.13 -				
FAR 510, FAS 510	05.13 -				
FAT 400	05.13 -				
FAT 410	05.13 -				
FAT 440	05.13 -				
FA 290	05.13 -		4300.90.89	430 10	- Engine code: MX-11 210
FAN 290, FAG 290	05.13 -		4301.20.00	MFZ430	- GBox: AS Tronic
FAR 290, FAS 290	05.13 -		4338.30.00	430WGTZ	
FAT 290	05.13 -		8939.40.00	KZISZ - 5	
FT 290	05.13 -		4300.90.334	430	- Engine code: MX-11 210
	05.13 -		43104.20.00	MFZ430	- GBox: Ecosplit4
	05.13 -		43134.30.00	430WGTZ	
	05.13 -		8939.40.00	KZISZ - 5	
			4371.20.00	430	- Engine code: MX-11 210
				MFZ430	- GBox: AS Tronic

Vehicle list



DAF

CF 05.13 -

FA 330	05.13 -		4300.90.89 4301.20.00 4338.30.00 8939.40.00	430 10 MFZ430 430WGTZ KZISZ - 5	- Engine code: MX-11 240 - GBox: AS Tronic
FA 370	05.13 -				
FAN 330, FAG 330	05.13 -				
FAN 370, FAG 370	05.13 -				
FAR 330, FAS 330	05.13 -		4366.30.00	430 10 430WGTZ	
FAR 370, FAS 370	05.13 -		8505.40.00	KZI - 4,5	
FAT 330	05.13 -				
FAT 370	05.13 -	4371.20.00	430 MFZ430	- Engine code: MX-11 240 - GBox: AS Tronic	
FT 330	05.13 -				
FT 370	05.13 -				
FAD 290	05.13 -		4300.90.89 4301.20.00 4338.30.00 8939.40.00	430 10 MFZ430 430WGTZ KZISZ - 5	- Engine code: MX-11 320 - GBox: AS Tronic, Ecosplit 4
FAD 330	05.13 -				
FAD 370	05.13 -				
FAQ 400, FAX 400	12.15 -		4300.90.189	430 10 MFZ430E 430WGTZ KZISZ - 5	- Engine code: MX-11 320 - GBox: AS Tronic, Ecosplit 4
FAQ 410, FAX 410	12.15 -		43100.20.00 43134.30.00 8939.40.00		
FAQ 440, FAX 440, 32t	12.15 -		4371.20.00	430 MFZ430	- Engine code: MX-11 320 - GBox: AS Tronic, Ecosplit 4
FAQ 460, FAX 460	12.15 -				
FAQ 510, FAX 510	12.15 -				
FAT 440	05.13 -		4300.90.89 4301.20.00 4338.30.00 8939.40.00	430 10 MFZ430 430WGTZ KZISZ - 5	- Engine code: MX-11 210 - GBox: AS Tronic
FAT 460	05.13 -				
FAT 510	05.13 -				
FT 400	05.13 -		4300.90.189	430 10 MFZ430E 430WGTZ KZISZ - 5	- GBox: AS Tronic
FT 410	05.13 -		43100.20.00 43134.30.00 8939.40.00		
FT 440	05.13 -				
FT 460	05.13 -				
FT 510	05.13 -				
FTG 400	05.13 -				
FTG 410	05.13 -				
FTG 440	05.13 -				
FTG 460	05.13 -				
FTG 510	05.13 -				
FTP 400	05.13 -				
FTP 410	05.13 -				
FTP 440	05.13 -				
FTP 460	05.13 -				
FTP 510	05.13 -				
FTR 410	05.13 -				
FTR 460	05.13 -				
FTR 510	05.13 -				
FTS 410	05.13 -				
FTS 460	05.13 -				
FTS 510	05.13 -				
FTT 400	05.13 -				
FTT 410	05.13 -				
FTT 440	05.13 -				
FTT 460	05.13 -				
FTT 510	05.13 -				

Vehicle list



DAF

85 CF 02.98 -

FA 85 CF 340	02.98 - 12.00	XF 250 M		4300.90.03	430 10	- GBox: ZF S16-151
FAC 85 CF 340	02.98 - 12.00			4301.20.00	MFZ430	
FAD 85 CF 340	02.98 - 12.00			4334.30.00	430GTZ	
FAG 85 CF 340,FAN 85 CF 340	02.98 - 12.00			8916.40.00	KZIZ - 5	
FAR 85 CF 340	02.98 - 12.00			4200.90.83	420 10	- GBox: Fuller
FAS 85 CF 340	02.98 - 12.00			4256.20.00	GMF420K	
FAT 85 CF 340	02.98 - 12.00			4259.30.00	420GSZ	
				9101.40.00	KZI - 5	
				4300.90.181	430 10	- GBox: 8/16S-151/181/221
				43100.20.00	MFZ430E	- Only install together
				4334.30.00	430GTZ	
				8916.40.00	KZIZ - 5	
FT 85 CF 340	02.98 - 12.00	XF 250 M		4300.90.03	430 10	- GBox: ZF S16-151
FTG 85 CF 340	02.98 - 12.00			4301.20.00	MFZ430	
FTT 85 CF 340	02.98 - 12.00			4334.30.00	430GTZ	
				8916.40.00	KZIZ - 5	
				4200.90.83	420 10	- GBox: Fuller
				4256.20.00	GMF420K	
				4259.30.00	420GSZ	
				9101.40.00	KZI - 5	
				4300.90.181	430 10	- GBox: 8/16S-151/181/221
				43100.20.00	MFZ430E	- Only install together
				4334.30.00	430GTZ	
				8916.40.00	KZIZ - 5	
FA 85 CF 380	02.98 - 12.00	XF 280 M		4300.90.03	430 10	- GBox: ZF S16-181
FA 85 CF 430	02.98 - 12.00	XF 315 M		4301.20.00	MFZ430	
FAC 85 CF 380	02.98 - 12.00			4334.30.00	430GTZ	
FAC 85 CF 430	02.98 - 12.00			8916.40.00	KZIZ - 5	
FAD 85 CF 380	02.98 - 12.00			4200.90.83	420 10	- GBox: Fuller
FAD 85 CF 430	02.98 - 12.00			4256.20.00	GMF420K	
FAG 85 CF 380,FAN 85 CF 380	02.98 - 12.00			4259.30.00	420GSZ	
FAG 85 CF 430,FAN 85 CF 430	02.98 - 12.00			9101.40.00	KZI - 5	
FAR 85 CF 380	02.98 - 12.00			4300.90.181	430 10	- GBox: 8/16S-151/181/221
FAR 85 CF 430	02.98 - 12.00			43100.20.00	MFZ430E	- Only install together
FAS 85 CF 380	02.98 - 12.00			4334.30.00	430GTZ	
FAS 85 CF 430	02.98 - 12.00			8916.40.00	KZIZ - 5	
FAT 85 CF 380	02.98 - 12.00					
FAT 85 CF 430	02.98 - 12.00					
FT 85 CF 380	02.98 - 12.00	XF 280 M		4300.90.03	430 10	- GBox: ZF S16-181
FT 85 CF 430	02.98 - 12.00	XF 315 M		4301.20.00	MFZ430	
FTG 85 CF 380	02.98 - 12.00			4334.30.00	430GTZ	
FTG 85 CF 430	02.98 - 12.00			8916.40.00	KZIZ - 5	
FTT 85 CF 380	02.98 - 12.00			4200.90.83	420 10	- GBox: Fuller
FTT 85 CF 430	02.98 - 12.00			4256.20.00	GMF420K	
				4259.30.00	420GSZ	
				9101.40.00	KZI - 5	
				4300.90.181	430 10	- GBox: 8/16S-151/181/221
				43100.20.00	MFZ430E	- Only install together
				4334.30.00	430GTZ	
				8916.40.00	KZIZ - 5	

Vehicle list



DAF

CF 85 01.01 -

Model	Configuration	Options	Price	Code	Notes
FA 85.340	01.01 -	XE 250 C	4300.90.03	430 10	- GBox: ZF 16S-151/181/221
FA 85.380	01.01 -	XE 280 C	4301.20.00	MFZ430	
FA 85.430	01.01 -	XE 315 C	4334.30.00	430GTZ	
FA 85.480	01.01 -	XE 355 C	8916.40.00	KZIZ - 5	
FAD 85.340	01.01 -		4300.90.181	430 10	- GBox: 16S-151/181/221
FAD 85.380	01.01 -		43100.20.00	MFZ430E	- Only install together
FAD 85.430	01.01 -		4334.30.00	430GTZ	
FAD 85.480	01.01 -		8916.40.00	KZIZ - 5	
FAG 85.340, FAN 85.340	01.01 -				
FAG 85.380, FAN 85.380	01.01 -				
FAG 85.430, FAN 85.430	01.01 -				
FAG 85.480, FAN 85.480	01.01 -				
FAR 85.340, FAS 85.340	01.01 -				
FAR 85.380, FAS 85.380	01.01 -				
FAR 85.430, FAS 85.430	01.01 -				
FAR 85.480, FAS 85.480	01.01 -				
FAT 85.340	01.01 -				
FAT 85.380	01.01 -				
FAT 85.430	01.01 -				
FAT 85.480	01.01 -				
FT 85.340	01.01 -				
FT 85.380	01.01 -				
FT 85.430	01.01 -				
FT 85.480	01.01 -				
FTG 85.340	01.01 -				
FTG 85.380	01.01 -				
FTG 85.480	01.01 -				
FTT 85.340	01.01 -				
FTT 85.380	01.01 -				
FTT 85.430	01.01 -				
FTT 85.480	01.01 -				

Vehicle list

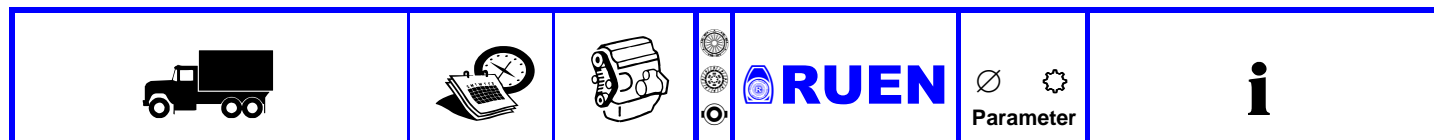

DAF

CF 85 01.01 -

FA 85.360	10.06 - 05.13	05 2013	MX		4300.90.72	430 10	- GBox: Ecosplit
	10.06 - 05.13	265			4301.20.00	MFZ430	
FA 85.410	10.06 - 05.13	05 2013	MX		4338.30.00	430WGTZ	
	10.06 - 05.13	300			8916.40.00	KZIZ - 5	
FA 85.460	10.06 - 05.13	05 2013	MX		4300.90.69	430 10	- GBox: AS Tronic
	10.06 - 05.13	340			4301.20.00	MFZ430	
FA 85.510	10.06 - 05.13	05 2013	MX		4332.30.00	430GTZ	
	10.06 - 05.13	375			8939.40.00	KZISZ - 5	
FAC 85.360	10.06 - 05.13				4300.90.188	430 10	- GBox: Ecosplit
FAC 85.410	10.05 - 05.13				43100.20.00	MFZ430E	
FAX 85.410	10.05 - 05.13				43134.30.00	430WGTZ	
FAC 85.460	10.05 - 05.13				8916.40.00	KZIZ - 5	
FAX 85.460	10.05 - 05.13				4300.90.189	430 10	- GBox: AS Tronic
FAC 85.510	10.05 - 05.13				43100.20.00	MFZ430E	- Use release fork with rollers
FAX 85.510	10.05 - 05.13				43134.30.00	430WGTZ	
FAD 85.360	10.06 - 05.13				8939.40.00	KZISZ - 5	
	10.06 - 05.13				4371.20.00	430	- GBox: Ecosplit, AS Tronic
	10.06 - 05.13					MFZ430	
	10.06 - 05.13				4300.90.171	430 10	- Transmission type: Ecosplit
	10.06 - 05.13				4301.20.00	MFZ430	
FAD 85.410	10.06 - 05.13				4338.30.00	430WGTZ	
	10.05 - 05.13				8916.40.00	KZIZ - 5	
	10.06 - 05.13						
	10.06 - 05.13						
	10.06 - 05.13						
	10.06 - 05.13						
FAD 85.460	10.05 - 05.13						
	10.06 - 05.13						
	10.06 - 05.13						
	10.06 - 05.13						
	10.05 - 05.13						
FAD 85.510	10.06 - 05.13						
	10.05 - 05.13						
	10.05 - 05.13						
	10.06 - 05.13						
	10.05 - 05.13						
FAG 85.360, FAN 85.360	10.06 - 05.13						
FAG 85.410, FAN 85.410	10.05 - 05.13						
FAG 85.460, FAN 85.460	10.05 - 05.13						
FAG 85.510, FAN 85.510	10.05 - 05.13						
FAN 85.360	10.06 - 05.13						
FAN 85.410	10.06 - 05.13						
FAN 85.460	10.06 - 05.13						
FAN 85.510	10.06 - 05.13						
FAQ 85.360	10.06 - 05.13						
FAQ 85.410	10.06 - 05.13						
FAQ 85.460	10.06 - 05.13						
FAQ 85.510	10.06 - 05.13						

Vehicle list



DAF

CF 85		01.01 -					
FAC 85.340	12.05 - 05.13	05 2013	MX		4300.90.14	430 10	- GBox: 16S-151/181/221
FAX 85.360	10.06 - 05.13	265			4303.20.00	MFZ430	
FAC 85.380	12.05 - 05.13	05 2013	XE		4334.30.00	430GTZ	
FAC 85.430	12.05 - 05.13	250 C			8916.40.00	KZIZ - 5	
FAC 85.480	12.05 - 05.13	05 2013	XE		4300.90.181	430 10	- GBox: 16S-151/181/221
FAX 85.340	01.01 - 05.13	280 C			43100.20.00	MFZ430E	- Only install together
FAX 85.380	01.01 - 05.13	05 2013	XE		4334.30.00	430GTZ	
FAX 85.430	01.01 - 05.13	355 C			8916.40.00	KZIZ - 5	
FAX 85.480	01.01 - 05.13						
FTP 85.340	01.01 - 05.13						
FTP 85.380	01.01 - 05.13						
FTP 85.430	01.01 - 05.13						
FTP 85.480	01.01 - 05.13						
FTS 85.480	01.01 - 05.13						
FTT 85.430	01.01 - 05.13						
FT 85.410	10.05 - 05.13				4300.90.72	430 10	
FT 85.460	10.05 - 05.13				4301.20.00	MFZ430	
					4338.30.00	430WGTZ	
					8916.40.00	KZIZ - 5	
					4371.20.00	430	- GBox: Ecosplit, AS Tronic
						MFZ430	
FAR 85.360	10.06 - 05.13				4300.90.72	430 10	- GBox: Ecosplit
FAR 85.360, FAS 85.360	10.06 - 05.13				4301.20.00	MFZ430	
	10.06 - 05.13				4338.30.00	430WGTZ	
	10.06 - 05.13				8916.40.00	KZIZ - 5	
FAR 85.410	10.05 - 05.13						
FAR 85.410, FAS 85.410	10.05 - 05.13				4300.90.69	430 10	- GBox: AS Tronic
	10.05 - 05.13				4301.20.00	MFZ430	
	10.05 - 05.13				4332.30.00	430GTZ	
	10.05 - 05.13				8939.40.00	KZISZ - 5	
FAR 85.460	10.05 - 05.13						
FAR 85.460, FAS 85.460	10.05 - 05.13				4300.90.188	430 10	- GBox: Ecosplit
	10.05 - 05.13				43100.20.00	MFZ430E	
	10.05 - 05.13				43134.30.00	430WGTZ	
	10.05 - 05.13				8916.40.00	KZIZ - 5	
FAR 85.510	10.05 - 05.13						
FAR 85.510, FAS 85.510	10.05 - 05.13				4300.90.189	430 10	- GBox: AS Tronic
	10.06 - 05.13				43100.20.00	MFZ430E	- Use release fork with rollers
	10.05 - 05.13				43134.30.00	430WGTZ	
	10.05 - 05.13				8939.40.00	KZISZ - 5	
FTG 85.360	10.06 - 05.13				4371.20.00	430	- GBox: Ecosplit, AS Tronic
FTG 85.410	10.05 - 05.13					MFZ430	
FTG 85.460	10.05 - 05.13						
FTG 85.510	10.05 - 05.13						
FTR 85.360, FTS 85.360, FTP 85.360	10.06 - 05.13				4300.90.17	430 10	- GBox: Ecosplit
FTR 85.410, FTS 85.410, FTP 85.410	10.05 - 05.13				4311.20.00	MFZ430	
FTR 85.460, FTS 85.460, FTP 85.460	10.05 - 05.13				4346.30.00	430WGTZ	
FTR 85.510, FTS 85.510, FTP 85.510	10.05 - 05.13				8919.40.00	KZISZ - 5	
FTT 85.360	10.06 - 05.13						
FTT 85.410	10.05 - 05.13						
FTT 85.460	10.05 - 05.13						
FTT 85.510	10.05 - 05.13						

Vehicle list

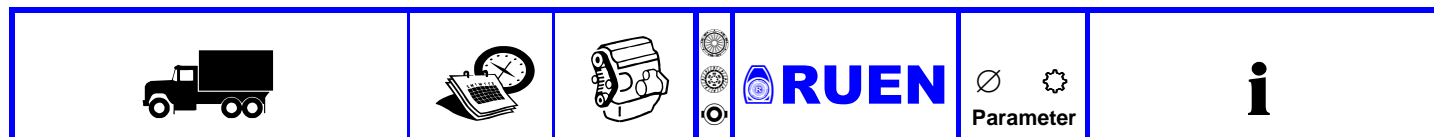

DAF

CF 85 10.05 -

FA 85.360	10.06 -		4300.90.72	430 10	- GBox: Ecosplit
FA 85.410	10.06 -		4301.20.00	MFZ430	
FA 85.460	10.06 -		4338.30.00	430WGTZ	
FA 85.510	10.06 -		8916.40.00	KZIZ - 5	
FAC 85.360, FAX 85.360	10.06 -				
FAC 85.410, FAX 85.410	10.05 -				
FAC 85.460, FAX 85.460	10.05 -				
FAC 85.510, FAX 85.510	10.05 -				
FAD 85.360	10.06 -				
FAD 85.410	10.05 -				
FAD 85.460	10.05 -				
FAD 85.510	10.05 -				
FAG 85.360, FAN 85.360	10.06 -				
FAG 85.410, FAN 85.410	10.05 -				
FAG 85.460, FAN 85.460	10.05 -				
FAG 85.510, FAN 85.510	10.05 -				
FAR 85.360, FAS 85.360	10.06 -				
FAR 85.410, FAS 85.410	10.05 -				
FAR 85.460, FAS 85.460	10.05 -				
FAR 85.510, FAS 85.510	10.05 -				
FTG 85.360	10.06 -				
FTG 85.410	10.05 -				
FTG 85.510	10.05 -				
FTR 85.360; FTS 85.360, FTP 85.360	10.06 -				
FTR 85.410, FTS 85.410, FTP 85.410	10.05 -				
FTR 85.460, FTS 85.460, FTP 85.460	10.05 -				
FTR 85.510, FTS 85.510, FTP 85.510	10.05 -				
FTT 85.360	10.06 -				

95 08.87 - 01.98

FA 95.310	09.87 - 09.90	WS 225	4200.90.78	420 10	
FA 95.350	09.87 - 09.90	WS 259	4256.20.00	GMF420K	
FAC 95.310	09.87 - 01.98		4287.30.00	420GVZ	
FAC 95.350	09.87 - 01.98		8505.40.00	KZI - 4,5	
FAD 95.310	09.87 - 01.98				
FAD 95.350	09.87 - 09.90				
FAG 95.350, FAR 95.350, FAS 95.350	09.87 - 09.90				
FAG 95.350, FAR 95.350, FAS 95.350	09.87 - 09.90				
FAR 95.310	09.87 - 09.90				
FAT 95.350	09.87 - 09.90				
FT 95.310	09.87 - 09.90				
FT 95.350	09.87 - 09.90				
FTG 95.310	09.87 - 01.98				
	09.87 - 01.98				
FTG 95.350, FTS 95.350	09.87 - 09.90				
FTG 95.350, FTS 95.350	09.87 - 09.90				
FTT 95.310	09.87 - 01.98				
FTT 95.330	09.87 - 01.98				
FTT 95.350	09.87 - 09.90				

Vehicle list

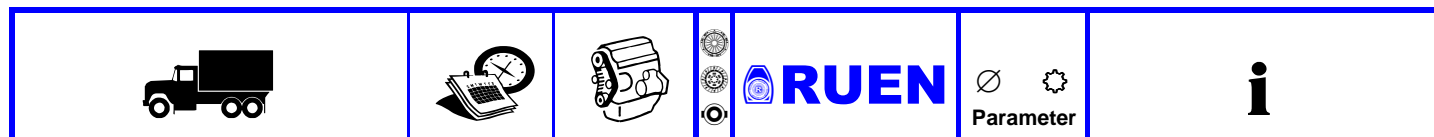

DAF

95 08.87 - 01.98

FA 95.330	08.90 - 01.93	WS 242	4200.90.82	420 10	
FA 95.360	08.90 - 01.98	WS 268	4256.20.00	GMF420K	
FAC 95.330	08.90 - 01.98	WS 268 G	4259.30.00	420GSZ	
FAC 95.360	08.90 - 01.98	WS 268 L	9101.40.00	KZI - 5	
FAD 95.330	08.90 - 01.98	WS 268 M			
FAD 95.360	08.90 - 01.98				
FAG 95.360, FAR 95.360, FAS 95.360	08.90 - 01.98				
FAG 95.360,FAR 95.360,FAS 95.360	08.90 - 01.98				
FAK 95.360	08.90 - 01.98				
FAR 95.330,FAS 95.330	08.90 - 01.93				
FAT 95.360	08.90 - 01.98				
FT 95.330	08.90 - 01.93				
FT 95.360	08.90 - 01.98				
FTG 95.330	08.90 - 01.98				
	08.90 - 01.98				
FTG 95.360, FTR 95.360, FTS 95.360	08.90 - 01.98				
FTG 95.360,FTR 95.360,FTS 95.360	08.90 - 01.98				
FTT 95.360	08.90 - 01.98				
FA 95.380	09.87 - 09.90	WS 282	4200.90.77	420 10	
FAC 95.380	09.87 - 01.98		4256.20.00	GMF420K	
FAD 95.380	09.87 - 09.90		4244.30.00	420/210GSZ	
FAG 95.380, FAR 95.380, FAS 95.380	09.87 - 09.90		8505.40.00	KZI - 4,5	
FAG 95.380,FAR 95.380,FAS 95.380	09.87 - 09.90				
FAT 95.380	09.87 - 09.90				
FTG 95.380, FTS 95.380	09.87 - 09.90				
FA 95.400	08.90 - 01.98	WS 282	4200.90.83	420 10	
FA 95.430	02.92 - 01.98	WS 295	4256.20.00	GMF420K	
FAD 95.400	08.90 - 01.98	WS 295 G	4259.30.00	420GSZ	
FAD 95.430	02.92 - 01.98	WS 295 L	9101.40.00	KZI - 5	
FAG 95.400,FAR 95.400,FAS 95.400	08.90 - 01.98	WS 295 M	4200.90.02	420 10	
FAG 95.430,FAR 95.430,FAS 95.430	02.92 - 01.98	WS 315	4256.20.00	GMF420K	
FAK 95.400	08.90 - 01.98	WS 315 G	4259.30.00	420GSZ	
FAK 95.430	02.92 - 01.98	WS 315 L	9101.40.00	KZI - 5	
FAT 95.400	08.90 - 01.98	WS 315 M			
WS 315 L (02/1992 - 01/1998)					
WS 315 M					
FAT 95.430	02.92 - 01.98				
FT 95.380	09.87 - 09.90				
FT 95.400	08.90 - 01.98				
FT 95.430	02.92 - 01.98				
FTG 95.380,FTS 95.380	09.87 - 09.90				
FTG 95.400, FTR 95.400, FTS 95.400	08.90 - 01.98				
FTG 95.400,FTR 95.400,FTS 95.400	08.90 - 01.98				
FTG 95.430, FTR 95.430, FTS 95.430	02.92 - 01.98				
FTG 95.430,FTR 95.430,FTS 95.430	02.92 - 01.98				
FTT 95.380	09.87 - 09.90				
FTT 95.400	08.90 - 01.98				
FTT 95.430	02.92 - 01.98				
FT 95.500	02.94 - 01.98	VF 373 M	4300.90.03	430 10	
			4301.20.00	MFZ430	
			4334.30.00	430GTZ	
			8916.40.00	KZIZ - 5	

Vehicle list



DAF

95 08.87 - 01.98

FAC 95.400	08.90 - 01.98		4200.90.83	420 10	
FAC 95.430	02.92 - 01.98		4256.20.00	GMF420K	
FAG 95.400, FAR 95.400, FAS 95.400	08.90 - 01.98		4259.30.00	420GSZ	
FAG 95.430, FAR 95.430, FAS 95.430	02.92 - 01.98		9101.40.00	KZI - 5	

XF 10.12 -

FA 410	10.12 -		4300.90.89	430 10	- GBox: AS Tronic, Ecosplit 4
FA 440	10.12 -		4301.20.00	MFZ430	
FA 460	10.12 -		4338.30.00	430WGTZ	
FA 510	10.12 -		8939.40.00	KZISZ - 5	
FAD 460	10.12 -		4371.20.00	430	- GBox: AS Tronic, Ecosplit
FAD 510	10.12 -			MFZ430	
FAN 410	10.12 -				
FAN 440	10.12 -				
FAN 460	10.12 -				
FAN 510	10.12 -				
FAR 410	10.12 -				
FAR 410, FAS 410	10.12 -				
FAR 440	10.12 -				
FAR 440, FAS 440	10.12 -				
FAR 460	10.12 -				
FAR 460, FAS 460	10.12 -				
FAR 510	10.12 -				
FAR 510, FAS 510	10.12 -				
FT 410	10.12 -				
FT 440	10.12 -				
FT 460	10.12 -				
FT 510	10.12 -				
FTG 410	10.12 -				
FTG 440	10.12 -				
FTG 460	10.12 -				
FTG 510	10.12 -				
FTP 410	10.12 -				
FTP 440	10.12 -				
FTP 460	10.12 -				
FTP 510	10.12 -				
FTT 460	10.12 -				
FTT 510	10.12 -				

Vehicle list



DAF

95 XF 01.97 - 09.02

FA 95 XF 380	01.97 - 09.02	XE 280 C		4300.90.03	430 10	- GBox: ZF S16-181
FA 95 XF 430	01.97 - 09.02	XE 315 C		4301.20.00	MFZ430	
FAC 95 XF 380	01.97 - 09.02	XF 280 M		4334.30.00	430GTZ	
FAC 95 XF 430	01.97 - 09.02	XF 315 M		8916.40.00	KZIZ - 5	
FAD 95 XF 380	01.97 - 09.02			4200.90.83	420 10	- GBox: Fuller
FAD 95 XF 430	01.97 - 09.02			4256.20.00	GMF420K	
FAR 95 XF 380	01.97 - 09.02			4259.30.00	420GSZ	
FAR 95 XF 430	01.97 - 09.02			9101.40.00	KZI - 5	
FAS 95 XF 380	01.97 - 09.02			4200.90.02	420 10	- GBox: Fuller
FAS 95 XF 430	01.97 - 09.02			4256.20.00	GMF420K	
FAT 95 XF 380	01.97 - 09.02			4259.30.00	420GSZ	
FAT 95 XF 430	01.97 - 09.02			9101.40.00	KZI - 5	
FT 95 XF 380	01.97 - 09.02					
FT 95 XF 430	01.97 - 09.02					
FTG 95 XF 380	01.97 - 09.02					
FTG 95 XF 430	01.97 - 09.02					
FTR 95 XF 380	01.97 - 09.02					
FTR 95 XF 430	01.97 - 09.02					
FTS 95 XF 380	01.97 - 09.02					
FTS 95 XF 430	01.97 - 09.02					
FTT 95 XF 380	01.97 - 09.02					
FTT 95 XF 430	01.97 - 09.02					
FA 95 XF 480	01.97 - 09.02	FA 95 XF 530		4200.90.83	420 10	- GBox: Fuller
FA 95 XF 530	01.97 - 09.02	VF 390 M		4256.20.00	GMF420K	
FAC 95 XF 480	01.97 - 09.02	XE 355 C		4259.30.00	420GSZ	
FAD 95 XF 480	01.97 - 09.02	XE 390 C		9101.40.00	KZI - 5	
FAR 95 XF 480	01.97 - 09.02	XF 355 M		4300.90.03	430 10	- GBox: ZF S16-221
FAR 95 XF 530	01.97 - 09.02			4301.20.00	MFZ430	
FAS 95 XF 480	01.97 - 09.02			4334.30.00	430GTZ	
FAS 95 XF 530	01.97 - 09.02			8916.40.00	KZIZ - 5	
FAT 95 XF 480	01.97 - 09.02					
FT 95 XF 480	01.97 - 09.02					
FT 95 XF 530, 14000cc	01.97 - 09.02					
FT 95 XF 530, 12580cc	01.97 - 09.02					
FTG 95 XF 480	01.97 - 09.02					
FTR 95 XF 480	01.97 - 09.02					
FTS 95 XF 480	01.97 - 09.02					
FTT 95 XF 480	01.97 - 09.02					
FTT 95 XF 530	01.97 - 09.02					

XF 95 09.02 - 12.06

FA 95.380	09.02 - 12.06	XE 280 C		4300.90.03	430 10	- GBox: 16S-151/181/221
FA 95.430	09.02 - 12.06	XE 315 C		4301.20.00	MFZ430	
FA 95.480	09.02 - 12.06	XE 355 C		4334.30.00	430GTZ	
FA 95.530	09.02 - 12.06	XE 390 C		8916.40.00	KZIZ - 5	
FT 95.380	09.02 - 12.06			4300.90.181	430 10	- GBox: 16S-151/181/221
FT 95.430	09.02 - 12.06			43100.20.00	MFZ430E	- Only install together
FT 95.480	09.02 - 12.06			4334.30.00	430GTZ	
FT 95.530	09.02 - 12.06			8916.40.00	KZIZ - 5	

Vehicle list



DAF

XF 95 09.02 - 12.06

FAD 95.380	01.02 - 12.06		4300.90.03	430 10	- GBox: 16S-151/181/221
FAD 95.430	01.02 - 12.06		4301.20.00	MFZ430	
FAD 95.480	01.02 - 12.06		4334.30.00	430GTZ	
FAD 95.530	09.02 -		8916.40.00	KZIZ - 5	
FAK 95.380	01.02 - 12.06		4300.90.97	430 10	- GBox: ZF AS Tronic
FAK 95.430	01.02 - 12.06		4303.20.00	MFZ430	- Use release fork with rollers
FAK 95.480	01.02 - 12.06		4334.30.00	430GTZ	
FAK 95.530	09.02 -		8939.40.00	KZISZ - 5	
FAN 95.380	01.02 - 12.06		4300.90.181	430 10	- GBox: 16S-151/181/221
FAN 95.430	01.02 - 12.06		43100.20.00	MFZ430E	- Only install together
FAN 95.480	01.02 - 12.06		4334.30.00	430GTZ	
FAN 95.530	09.02 -		8916.40.00	KZIZ - 5	
FAR 95.380	09.02 - 12.06				
FAR 95.430	09.02 - 12.06				
FAR 95.480	09.02 - 12.06				
FAR 95.530	09.02 - 12.06				
FAS 95.380	01.02 - 12.06				
FAS 95.430	01.02 - 12.06				
FAS 95.480	01.02 - 12.06				
FAS 95.530	09.02 -				
FAT 95.380	01.02 - 12.06				
FAT 95.430	01.02 - 12.06				
FAT 95.480	01.02 - 12.06				
FAT 95.530	09.02 -				
FTG 95.380	09.02 - 12.06				
FTG 95.430	12.05 - 12.06				
FTG 95.480	12.05 - 12.06				
FTG 95.530	09.02 - 12.06				
FTM 95.380	12.05 - 12.06				
FTM 95.430	12.05 - 12.06				
FTM 95.480	12.05 - 12.06				
FTM 95.530	09.02 - 12.06				
FTP 95.380	01.02 - 12.06				
FTP 95.430	01.02 - 12.06				
FTP 95.480	01.02 - 12.06				
FTP 95.530	09.02 -				
FTR 95.380	01.02 - 12.06				
FTR 95.430	01.02 - 12.06				
FTR 95.480	01.02 - 12.06				
FTR 95.530	09.02 -				
FTS 95.380	01.02 - 12.06				
FTS 95.430	01.02 - 12.06				
FTS 95.480	01.02 - 12.06				
FTS 95.530	09.02 -				
FTT 95.380	01.02 - 03.06				
FTT 95.430	01.02 - 03.06				
FTT 95.480	01.02 - 03.06				
FTT 95.530	09.02 -				



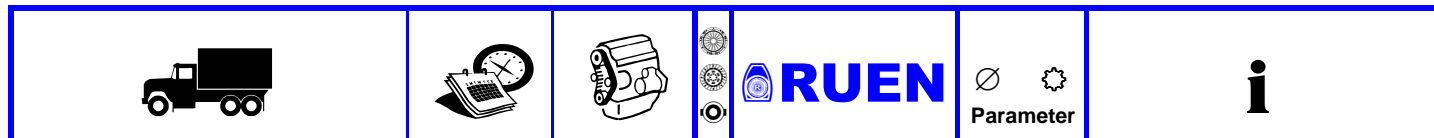



Vehicle list











































DAF

XF 105		10.05 -				
FA 105.410	10.05 -	MX 300		8916.40.00	KZIZ - 5	- GBox: ZF 16S-2020/2220
FA 105.460	10.05 -	MX 340		4300.90.72	430 10	- GBox: ZF 16S-2020, 2220
FA 105.510	10.05 -	MX 375		4301.20.00	MFZ430	
FAS 105.410, FAR 105.410, FAN 105.410	10.05 -			4338.30.00	430WGTZ	
FAS 105.460, FAR 105.460, FAN 105.460	10.05 -			8916.40.00	KZIZ - 5	
FAS 105.510, FAR 105.510, FAN 105.510	10.05 -			4300.90.188	430 10	- GBox: ZF16S-2020,2220
FT 105.410	10.05 -			43100.20.00	MFZ430E	
FT 105.460	10.05 -			43134.30.00	430WGTZ	
FT 105.510	10.05 -			8916.40.00	KZIZ - 5	
				4300.90.189	430 10	- GBox: AS Tronic
				43100.20.00	MFZ430E	- Use release fork with rollers
				43134.30.00	430WGTZ	
				8939.40.00	KZISZ - 5	
				4371.20.00	430	- GBox: ZF16S-2020,2220
					MFZ430	- GBox: AS Tronic
FAD 105.410	10.05 -			4300.90.72	430 10	- GBox: ZF16S-2020,2220
FAD 105.460	10.05 -			4301.20.00	MFZ430	
FAD 105.510	10.05 -			4338.30.00	430WGTZ	
FAK 105.410	10.05 -			8916.40.00	KZIZ - 5	
FAK 105.460	10.05 -			4300.90.69	430 10	- GBox: AS Tronic
FAK 105.510	10.05 -			4301.20.00	MFZ430	
FAR 105.410	10.05 -			4332.30.00	430GTZ	
FAR 105.510	10.05 -			8939.40.00	KZISZ - 5	
FAS 105.410, FAR 105.410, FAN 105.410	10.05 -			4300.90.188	430 10	- GBox: ZF16S-2020,2220
FAS 105.460, FAR 105.460, FAN 105.460	10.05 -			43100.20.00	MFZ430E	
FAS 105.510, FAR 105.510, FAN 105.510	10.05 -			43134.30.00	430WGTZ	
FAT 105.410	10.05 -			8939.40.00	KZISZ - 5	
FAT 105.460	10.15 -					
FAT 105.510	10.05 -					
FTM 105.410	10.05 -			4371.20.00	430	- GBox: ZF16S-2020,2220
FTM 105.460	10.05 -					- GBox: AS Tronic
FTM 105.510	10.05 -					
FTS 105.410, FTR 105.410, FTG 105.410	10.05 -					
FTS 105.460, FTR 105.460, FTG 105.460	10.05 -					
FTS 105.510, FTR 105.510, FTG 105.510	10.05 -					
FTT 105.410	10.05 -					
FTT 105.460	10.05 -					
FTT 105.510	10.05 -					
FAR 105.460	10.05 -			4300.90.72	430 10	
				4301.20.00	MFZ430	
				4338.30.00	430WGTZ	
				8916.40.00	KZIZ - 5	
				4300.90.188	430 10	- GBox: ZF16S-2020,2220
				43100.20.00	MFZ430E	
				43134.30.00	430WGTZ	
				8916.40.00	KZIZ - 5	
				4371.20.00	430	- GBox: ZF16S-2020,2220
					MFZ430	- GBox: AS Tronic

Vehicle list

					
---	---	---	--	---	---

DAF





XF 105		10.05 -				
FTP 105.410	10.05 -			4300.90.72	430 10	- GBox: ZF16S-2020,2220
FTP 105.460	10.05 -			4301.20.00	MFZ430	
FTP 105.510	10.05 -			4338.30.00	430WGTZ	
				8916.40.00	KZIZ - 5	
				4300.90.69	430 10	- GBox: AS Tronic
				4301.20.00	MFZ430	
				4332.30.00	430GTZ	
				8939.40.00	KZISZ - 5	
2600						
2600 DP				4205.20.00	420	
				4208.30.00	420 10	
				8514.40.00	420GS	
					KZI - 4,5	
2800						
2800				4257.20.00	420	- GBox: Fuller RT11613
				4259.30.00	420 10	- GBox: Fuller RT11613
				7951.40.00	420GSZ	- GBox: Fuller RT11613
					KZIS - 4	
400-SERIES		04.89 -				
2,0	04.89 -			2402.20.00	240	
				2400.90.06	242 23	- From model year: 09/1997
2,5 D				2403.20.00	MF240	
2,5 TD				2413.30.00	240TD	
				3205.40.00	KZIS - 0	
825						
825 DHU				4268.30.00	420 10	
					420GSZ	
SHERPA / FREIGHT ROVER						
1,7	03.89 -			2402.20.00	240	- From chassis no.: 271676
2,0	05.86 - 03.89				MF240	
2,0 D	09.86 - 03.89					
200 - SERIE						
1,7	04.89 - 08.92			2402.20.00	240	- GBox: 5 Gang / 5-speed
2,0	04.89 -				MF240	
2,0 D	04.89 -					
DAF (TÜRKİYE)						
1600 - 2100						
1600 - 2100				3524.20.00	350	
				3563.30.00	350 10	
					GF350KR	
					350GSZ	
2300 - 2500						
2300 - 2500				3878.20.00	380	
				38107.30.00	380 10	
					GMF380	
					380 GTZ	
3300 ATI - 360 ATI						
3300 ATI - 360 ATI				4256.20.00	420	
				4256.30.00	420 10	
					GMF420K	
					420GS	

Vehicle list

					
---	---	---	--	---	---

DAF (TÜRKİYE)

CF85 - XF95 SERISI





XF95 - CF 85		4303.20.00	430 MFZ430	- GBox: ZF
		4256.20.00	420 GMF420K	- GBox: FULLER
		4334.30.00	430 10 430GTZ	- GBox: ZF / FULLER
		8916.40.00	KZIZ - 5	

DEMAG

S...







SKD		2013.30.00	200 10 200S	
-----	---	-------------------	-----------------------	--

V...

V 35		2260.20.00	225 KS225	
		2256.30.00	225 10 225Z	
V 42		2518.20.00	250 G250	
		2511.30.00	250 10 250Z	



ENASA

1217 - 1437

1217		4269.20.00	420 GMF420K	
1223		4269.20.00	420 GMF420K	
		4291.30.00	420 10 420GSZ	
1232		4310.30.00	430 10 430WGVZ	
1234		4300.20.00	430 MFZ430	
1236				
1278				
1437		4269.20.00	420 GMF420K	
		4292.30.00	420 10 420GSZ	





EVOBUS

Pistenbully







Pistenbully		3120.20.00	310 GFX310	
		3126.30.00	310 10 310GSBL	

FAUN

A

AK 320 HB (DB-Mot.)		2507.20.00	250 HBX250	
		2528.30.00	250 10 250BHZX	
AK 320 HB (MWM-Mot.)		2812.20.00	280 HVB280	10.54 -
		2805.30.00	280 10 280BHZ	
AK 470 HB		3588.30.00	350 10 350GSZ	

Vehicle list

					
---	---	---	--	---	---

FAUN

A

AS 22	01.48 -		2262.20.00	225 KS225
-------	---------	---	-------------------	---------------------

F 24 - 284

F 24			2517.20.00	250 G250K
------	--	---	-------------------	---------------------

F 284 D			2518.30.00	250 10 250GSZ
---------	--	---	-------------------	-------------------------

F 56 /39 KA F 56 /41 K F 56 /43			3131.20.00	310 G310
---------------------------------------	--	---	-------------------	--------------------

F 50 /440 V			3130.20.00	310 G310K
-------------	--	---	-------------------	---------------------

			3588.30.00	350 10 350GSZ
--	--	---	-------------------	-------------------------

F 610 - 837

F 610 /36 SA F 610 /36 ZAN F 610 /362			3807.20.00	380 G380KR
---	--	---	-------------------	----------------------

F 610 /36 VS F 610 /39 KAN			4201.20.00	420 G420KR
-------------------------------	--	---	-------------------	----------------------

F 610 /450 VL F 610 /465 V F 687 /43 KAN F 687 /44 KAN F 687 /49 V F 688 /36 S F 688 A F 689 /36 S F 689 /36 V F 689 /36 VS F 689 /41 KAN F 689 /47 K F 689 VL			8505.40.00	KZI - 4,5
--	--	--	-------------------	-----------

F 6083 - 6103

F 6083 /42 K F 6083 /42 KA			4201.20.00	420 G420KR
-------------------------------	--	---	-------------------	----------------------

F 6083 /475 VL F 6103 /34 VS F 6103 /42 K F 6103 /42 KA F 6103 /475 VL			8505.40.00	KZI - 4,5
--	--	---	-------------------	-----------

K 20/37 - K 40/40

K 20/37 K 20/37 A			3505.20.00	350 G350KR
----------------------	--	---	-------------------	----------------------







K 20/37 V K 20/37 VA			8505.40.00	KZI - 4,5
-------------------------	--	---	-------------------	-----------

K 20/37 K 20/37 A			4201.20.00	420 G420KR
----------------------	--	---	-------------------	----------------------

			8505.40.00	KZI - 4,5
--	--	---	-------------------	-----------

























K 25/36 A K 25/36 V K 25/36 VA K 40/40 VL			3807.20.00	380 G380KR
--	--	---	-------------------	----------------------

Vehicle list

			 RUEN	 Parameter	
---	---	---	--	--	---

FAUN







KF 15.21 - 100.53

KF 15.21 /30 4x4 KF 15.21 /32 4x4			 3807.20.00	380 G380KR				
			 8505.40.00	KZI - 4,5				
KF 20.31 /42 (6 Zyl. Mot.) KF 20.31 /48 6x4 KF 20.31 /48 6x6			 3505.20.00	350 G350KR				
			 3512.30.00	350 10 350W2GSZ				
			 8505.40.00	KZI - 4,5				
			 3895.20.00	380 G380KR				
			 3812.30.00	380 10 380GSZ				
KF 30.31 /48 KF 30.41 /48 (8-Zyl.-Mot) KF 40.41 /50 (8-Zyl.-Mot)			 3895.20.00	380 G380KR				
KF 30.31 /48 6x6			 3505.20.00	350 G350KR				
			 8505.40.00	KZI - 4,5				
			 4201.20.00	420 G420KR				
KF 30.31 /54 6x6			 4201.20.00	420 G420KR				
			 4244.30.00	420 10 420/210GSZ				
KF 30.41 /48 KF 30.41 /48 6x4 KF 30.41 /48 8x4			 3505.20.00	350 G350KR				
			 8505.40.00	KZI - 4,5				
KF 30.41 /48 8x6 KF 50.42 /483 8x6			 3807.20.00	380 G380KR				
			 4201.20.00	420 G420KR				
			 8505.40.00	KZI - 4,5				
KF 30.41 /48 8x8 KF 60.43 /50 8x4 KF 60.43 /50 8x6 KF 60.43 /55 8x6 KF 60.52 /55 10x6 KF 70.43 /55 8x6			 3807.20.00	380 G380KR				
			KF 40.41 /48 10 Zyl. KF 40.41 /48 8x6 KF 40.41 /48 8x8 KF 50.42 /48 10-Zyl. KF 50.42 /48 8x6	 4201.20.00	420 G420KR			
				 8505.40.00	KZI - 4,5			
			KF 40.41 /48 8 Zyl. KF 40.41 /48 8x4 KF 50.42 /48 8-Zyl.			 3895.20.00	380 G380KR	
						 3812.30.00	380 10 380GSZ	
 8505.40.00	KZI - 4,5							

L 908 - L 1212

















L 1212 L 1212 /375 VS 8x6 L 1212 /45 ZA			 3807.20.00	380 G380KR	
---	--	--	---	----------------------	--

Vehicle list



					
---	---	---	--	---	---

FAUN

LK 116 - LK 1512

LK 116 /42 V 6x6 LK 606 /32 V LK 606 /38 V LK 906 /48 V LK 906 /48 V 6-Zyl.				3807.20.00	380 G380KR	
				8505.40.00	KZI - 4,5	
LK 606 /38 6x6				3895.20.00	380 G380KR	
				3812.30.00	380 10 380GSZ	
				8505.40.00	KZI - 4,5	
LK 906 /45 V LK 906 /45 V 6x6 LK 910 /483 10-Zyl. LK 910 /483 V LK 1210 /50 V 8x6 LK 1212 /485 III LK 1412 LK 1412 /64 V 10x6 LK 1508 /36 V LK 1512 /38 V 4x4				3807.20.00	380 G380KR	
LK 906 /48 6x4 LK 906 /48 V 6x4 LK 906 /48 V 8-Zyl. LK 906 /48 VH 6x4 LK 906 /60 V LK 910 /483				3505.20.00	350 G350KR	
				8505.40.00	KZI - 4,5	
LK 906 /48 6x6				3505.20.00	350 G350KR	
				8505.40.00	KZI - 4,5	
				4201.20.00	420 G420KR	
LK 908 /48				3505.20.00	350 G350KR	
				8505.40.00	KZI - 4,5	
				3807.20.00	380 G380KR	
				4201.20.00	420 G420KR	
LK 910 /483 8-Zyl.				4201.20.00	420 G420KR	
				8505.40.00	KZI - 4,5	

TF

TF 00.31/52 6x4				3895.20.00	380 G380KR	
				3812.30.00	380 10 380GSZ	
				8505.40.00	KZI - 4,5	







FIAT

DOBLO MPV (119_, 223_)

03.01 -

1.9 JTD (223AXE1A) 1.9 JTD 1.9 D Multijet	10.01 - 07.03 - 10.05 -	182 B9.000 186 A9.000 223 A7.000 223 B1.000 223 B2.000		3903.40.00	KZIS-0	
---	-------------------------------	--	---	-------------------	--------	--

Vehicle list

					
---	---	---	--	---	---

FIAT

DOBLO Cargo (223_)

11.00 -

1.9 JTD (223ZXE1A)	10.01 -	182 B9.000		3903.40.00	KZIS-0	
1.9 JTD	07.03 -	223 A7.000				
		223 B1.000				





DOBLO Box Body / Estate (263_)

02.10 -

1.6 D Multijet, 66kW	02.10 -	198 A3.000		3903.40.00	KZIS-0	- Engine code: 263A4.000 - Engine code: 198 A3.000 - GBox: Selespeed
1.6 D Multijet, 74kW	02.10 -	263 A3.000				
1.6 D Multijet, 77kW	02.10 -	263 A4.000				
		263 A5.000				
		263 A8.000				
		263 A9.000				

DUCATO Box (280_)







01.82 - 09.90

1.8	01.82 - 10.88	169 B		2150.90.18	215 21	- To model year: 05.1985
2.0	01.82 - 08.90	XN 1T		 2185.20.00		
				 2178.30.00		
				 3211.40.00		
				CP215		
				215CE		
				KZIS - 0		

FORD







TRANSIT Box (V_)

01.77 - 10.86

1.6 (WS)	11.77 - 10.86	4RB		2150.90.10	215 23	- From model year: 01/1978 - Engine code: OHC - GBox: F-Typ
				 2171.20.00		
				 2172.30.00		
				 3206.40.00		
				MF215K		
				215D		
				KZIS - 1		
				2172.30.00	215 23	- From model year: 01/1978 - Engine code: OHC - GBox: F-Typ
				215D		
				3206.40.00	KZIS - 1	- From model year: 01/1978 - Engine code: OHC - GBox: F-Typ









TRANSIT Platform/Chassis (V_)

11.77 - 10.86

1.6 (VCS, VDS)	11.77 - 10.86	B		2150.90.10	215 23	- From model year: 01/1978 - Engine code: OHC - GBox: F-Typ
				 2171.20.00		
				 2172.30.00		
				 3206.40.00		
				MF215K		
				215D		
				KZIS - 1		
				2172.30.00	215 23	- From model year: 01/1978 - Engine code: OHC - GBox: F-Typ
				215D		
				3206.40.00	KZIS - 1	- From model year: 01/1978 - Engine code: OHC - GBox: F-Typ

TRANSIT Box (T_)

09.85 - 09.92

2.5 D (TAL, TAS, TGL, TWS)	01.86 - 09.91	4AB		2400.90.06	242 23	- From model year: 10.1988
				 2403.20.00		
				 2413.30.00		
				 3205.40.00		
				MF240		
				240TD		
				KZIS - 0		
2.5 D (TAL, TAS, TGL, TWS)	10.88 - 09.91	4BA 4CA		2400.90.06	242 23	
				 2403.20.00		
				 2413.30.00		
				 3205.40.00		
				MF240		
				240TD		
				KZIS - 0		

Vehicle list

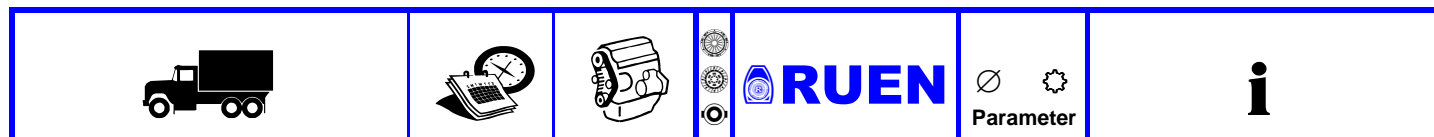

FORD

TRANSIT Box (T__) 09.85 - 09.92

1.6 (TAS)	09.85 - 09.92	LAT		2150.90.10	215 23	- Engine code: OHC - GBox: F-Typ
				2171.20.00	MF215K	
				2172.30.00	215D	
				3206.40.00	KZIS - 1	
				2172.30.00	215 23	- Engine code: OHC - GBox: F-Typ
				3206.40.00	215D	- Engine code: OHC - GBox: F-Typ
				3206.40.00	KZIS - 1	- Engine code: OHC - GBox: F-Typ
				3205.40.00	KZIS - 0	- From model year: 11/1988 - Engine code: OHC - GBox: F-Typ
				2413.30.00	240 23	- To model year: 07/1991 - GBox: MT75
2.0 (TAL, TAS, TGL, TWS)	09.85 - 09.92	NAT NAV		3205.40.00	240TD	- GBox: MT75
				2413.30.00	240 23	- To model year: 07/1991 - GBox: MT75

TRANSIT Platform/Chassis (T__) 10.85 - 09.92

2.5 D (TTL, TTS, TUL, TUS, TTE)	01.86 - 01.89	4AB		2400.90.06	242 23	- From model year: 10.1988
				2403.20.00	MF240	
				2413.30.00	240TD	
				3205.40.00	KZIS - 0	
2.5 DI (TTE, TTL, TTS, TUL)	09.88 - 09.92	4BA 4CA		2400.90.06	242 23	
				2403.20.00	MF240	
				2413.30.00	240TD	
				3205.40.00	KZIS - 0	
2.0 (TTE, TTL, TTS) 2.0 Cat (TUL)	01.86 - 09.92 11.85 - 09.92	N6T NAT NAV		3205.40.00	KZIS - 0	- GBox: MT75
				2413.30.00	240 23	- To model year: 07/1991 - GBox: MT75

TRANSIT Platform/Chassis (E__) 04.91 - 08.94

2.5 TD (EME/L/S, ENE/L/S) 2.5 TD (EME/L/S, ENE/L)	11.92 - 08.94 09.91 - 08.94	4EA 4GA 4GB 4GC		2400.90.06	242 23	
				2403.20.00	MF240	
				2413.30.00	240TD	
				3205.40.00	KZIS - 0	
2.0 (EME/L/S, ENE/L/S)	09.91 - 08.94	NCA		3205.40.00	KZIS - 0	- GBox: MT75
2.5 DI (EME/L/S, ENE/L/S) 2.5 DI (EML/S, ENL/S)	09.91 - 08.94 09.91 - 08.94	4AB 4BC 4CC 4DA 4FA		2400.90.06	242 23	
				2403.20.00	MF240	
				2413.30.00	240TD	
				3205.40.00	KZIS - 0	
				2403.20.00	MF240	
				2413.30.00	240TD	

TRANSIT Box (E__) 05.91 - 06.94

2.5 DI (EAL, EAS) 2.5 DI (EAS, EAL) 2.5 DI (EAL, EAS)	05.91 - 06.94 05.91 - 06.94 10.92 - 06.94	4BC 4CC 4DA 4FA 4GA		2400.90.06	242 23	
				2403.20.00	MF240	
				2413.30.00	240TD	
				3205.40.00	KZIS - 0	
				2403.20.00	MF240	
2.5 TD (EAS, EAL)	05.91 - 06.94	4EA		2400.90.06	242 23	
				2403.20.00	MF240	
				2413.30.00	240TD	
2.0 2.0 i (EAL, EAS)	09.91 - 06.94 09.91 - 06.94	NBA NCA		3205.40.00	KZIS - 0	- GBox: MT75

Vehicle list

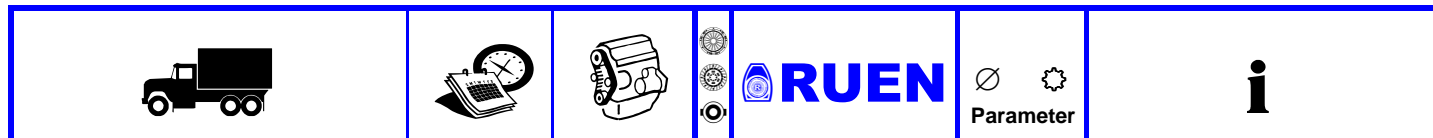

FORD

TRANSIT Box (E_) 06.94 - 07.00

2.5 DI (EAL, EAS), 51kW 2.5 DI (EAL, EAS), 56kW	06.94 - 03.00 06.94 - 03.00	4FA 4FB 4FC 4FD 4HB 4HC		2400.90.06 2403.20.00 2413.30.00 3205.40.00	242 23 MF240 240TD KZIS - 0	
2.5 TD (EAS) 2.5 DI (EAL, EAS)	10.98 - 03.00 05.99 - 03.00	4ED 4HA 4HD		2400.90.06 2403.20.00 2413.30.00 3205.40.00	242 23 MF240 240TD KZIS - 0	
2.5 TD (EAL, EAS) 2.5 TDI (EAL, EAS)	06.94 - 03.00 06.94 - 03.00	4EB 4EC 4GA 4GB 4GC 4GD 4GE 4GF		2400.90.06 2403.20.00 2413.30.00 3205.40.00	242 23 MF240 240TD KZIS - 0	
2.0 (EAL, EAS)	06.94 - 03.00	NSF NSG		3205.40.00	KZIS - 0	







TRANSIT Platform/Chassis (E_) 08.94 - 07.00

2.5 TD (EME/L/S, ENE/L/S) 2.5 DI (EML, ENE/L)	10.98 - 07.00 05.99 - 03.00	4ED 4HA 4HD		2400.90.06 2403.20.00 2413.30.00 3205.40.00	242 23 MF240 240TD KZIS - 0	
2.5 TD (EME/L/S, ENE/L/S), 63kW 2.5 TD (EME/L/S, ENE/L/S), 74kW	08.94 - 03.00 08.94 - 03.00	4EB 4EC 4GA 4GB 4GC 4GD 4GE 4GF		2400.90.06 2403.20.00 2413.30.00 3205.40.00	242 23 MF240 240TD KZIS - 0	
2.5 DI (EML/S, ENL/S) 2.5 DI (EME/L/S, ENE/L/S)	08.94 - 03.00 08.94 - 03.00	4FA 4FB 4FC 4FD 4HB 4HC		2400.90.06 2403.20.00 2413.30.00 3205.40.00	242 23 MF240 240TD KZIS - 0	
2.0 (EME/L/S, ENE/L/S)	08.94 - 03.00	NSF NSG		3205.40.00	KZIS - 0	

TRANSIT Box (FA_) 01.00 - 05.06

2.3 16V [RWD] (FAA_, FAB_, FAC_) 2.4 DI [RWD] (FAA_, FAB_, FAC_, FAD_), 55kW 2.4 DI (FAA_, FAB_, FAC_, FAD_) 2.4 TDE 2.4 DI [RWD] (FAA_, FAB_, FAC_, FAD_), 88kW 2.4 TDE	04.01 - 05.06 01.00 - 05.06 01.00 - 05.06 03.04 - 05.06 01.00 - 05.06 07.01 - 05.06	D2FA D2FB D2FE D4FA DOFA E5FA E5FC F4FA FXFA		3205.40.00	KZIS - 0	- From model year: 06/2002
---	--	--	--	-------------------	----------	----------------------------

Vehicle list

					
---	---	---	--	---	---

FORD

TRANSIT Platform/Chassis (FM_ 01.00 - 05.06

2.3 16V (F_A_, F_B_, F_C_, F_D_) 2.4 DI (F_A_, F_B_, F_C_, F_D_), 55kW 2.4 DI (F_A_, F_B_, F_C_, F_D_), 66kW 2.4 TDE 2.4 DI (F_A_, F_B_, F_C_, F_D_), 88kW 2.4 TDE	04.01 - 05.06 01.00 - 05.06 01.00 - 05.06 03.04 - 05.06 01.00 - 05.06 07.01 - 05.06	D2FA D2FB D2FE D4FA DOFA E5FA E5FC F4FA FXFA		3205.40.00	KZIS - 0	- From model year: 06/2002
--	--	--	---	-------------------	----------	----------------------------

TRANSIT Platform/Chassis 04.06 -

2.3 16V [RWD] 2.4 TDCi [RWD], 74kW	04.06 - 08.14 04.06 - 08.14	GZFA GZFB GZFC PHFA PHFC		3205.40.00	KZIS - 0	
---------------------------------------	--------------------------------	--------------------------------------	---	-------------------	----------	--

TRANSIT Box 04.06 -





2.3 16V [RWD]	04.06 - 08.14	GZFA GZFB GZFC		3205.40.00	KZIS - 0	
---------------	---------------	----------------------	---	-------------------	----------	--

Cargo 04.81 - 11.12

2632e/2932e/4432e/4532/5032e				3955.30.00	395 10 395WGTZ	
------------------------------	--	--	---	-------------------	--------------------------	--

















FORD (TÜRKİYE)

CARGO

CARGO 1312-1814-2014-2517				3258.30.00	325 10 325GSZ	
CARGO 2621 (Intercooler)				3574.30.00	350 10 14" 350GSZ	
CARGO 2520-2621 (Intercooler)				3574.20.00	350 14" MF 350	
YENİ CARGO 1824-1830-2524-2530-3230				3962.20.00	395 15.5" MF 395	
				3965.30.00	395 10 15.5" 395GTZ	

IVECO

DAILY I Box Body / Estate 01.78 - 08.98

30-8 (10014131, 10014132, 10014137, 10014231, 10014232...) 35-8 (10034131, 10034132, 10034137, 10034224, 10034231...)	01.78 - 12.89 01.78 - 12.89	8140.61.200		2400.90.01  2402.20.00  2402.30.00  4502.40.00	240 10 MF240 240PSD KZI - 1	- Engine code: 8140.61 - GBox: 2815
35-10 (10314204, 10314211, 10314212, 10314217, 10314411...)	01.85 - 12.89	8140.21.200		2350.90.01  2353.20.00  2354.30.00  4500.40.00	235 10 MFZ235 235CBL KZIZ - 3	- Engine code: 8140.27S - GBox: 2826.5
				2650.90.15  2658.20.00  2678.30.00  4500.40.00	265 10 MFZ265 265VTP KZIZ - 3	- Engine code: 8140.27S - GBox: 2826.5 - Equipment Var: Euro2
				2650.90.01  2651.20.00  2655.30.00  4502.40.00	265 10 MF265 265TB KZI - 1	- Engine code: 8140.21 - GBox: 2822

Vehicle list

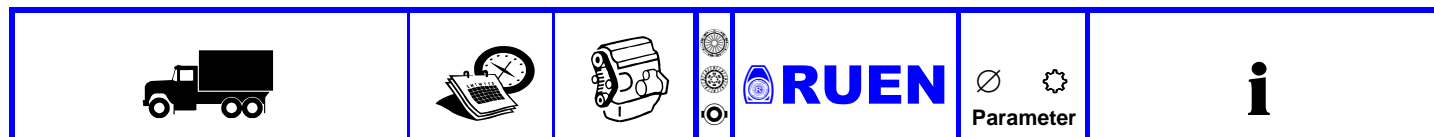

IVECO

DAILY I Box Body / Estate 01.78 - 08.98

40-10 V	01.85 - 12.89	8140.27 S		2650.90.01 2651.20.00 2655.30.00 4502.40.00	265 10 MF265 265TB KZI - 1	
45-10 V (10334204, 10334211, 10334212, 10334217, 10334404) 49-10 V (10354204, 10354211, 10354212, 10354217...)	01.85 - 12.89 01.85 - 12.89	8140.21.200		2650.90.01 2651.20.00 2655.30.00 4502.40.00	265 10 MF265 265TB KZI - 1	- Engine code: 8140.21 - GBox: 2824 - GBox: 822

DAILY I Platform/Chassis 01.78 - 05.99

30-8 (10011131, 10011132, 10011231, 10011232, 10011237...) 35-8 (10031131, 10031132, 10031137, 10031224, 10031231...) 40-8	01.78 - 12.89 01.78 - 12.89 01.83 - 06.89	8140.61.200		2400.90.01 2402.20.00 2402.30.00 4502.40.00	240 10 MF240 240PSD KZI - 1	- Engine code: 8140.61 - GBox: 2815
35-10 (10310311, 10311111, 10311112, 10311117, 10311211...) 45-10 (10331211, 10331212, 10331217, 10331304, 10331311...) 49-10 (10350211, 10350304, 10350311, 10350404, 10350411...)	01.85 - 12.89 01.85 - 12.89 01.85 - 12.89	8140.21.200		2650.90.01 2651.20.00 2655.30.00 4502.40.00	265 10 MF265 265TB KZI - 1	- Engine code: 8140.21 - GBox: 2822 - GBox: 2824
40-10	01.85 - 12.89	8140.27 S		2650.90.01 2651.20.00 2655.30.00 4502.40.00	265 10 MF265 265TB KZI - 1	

DAILY II Box Body / Estate 01.89 - 05.99

30-10 30-10 C	01.97 - 05.99 01.97 - 05.99	8140.23.		2350.90.01 2353.20.00 2354.30.00 4500.40.00	235 10 MFZ235 235CBL KZIZ - 3	
30-8 (12914111, 12914112, 12914117, 12914131, 12914137...), 55kW 30-8 (12914111, 12914112, 12914117, 12914131, 12914137...), 60kW 35-8 (12934104, 12934111, 12934112, 12934117, 12934124...), 55kW 35-8 (12934104, 12934111, 12934112, 12934117, 12934124...), 60kW	01.89 - 08.98 01.89 - 08.98 01.91 - 08.98 01.91 - 08.98	8140.07.2700 8140.07.2712 8140.67F. 8140.67F.3701 8140.67F.3710 8140.67F.3711 8140.67F.3713 8140.67F.3721		2350.90.01 2353.20.00 2354.30.00 4500.40.00	235 10 MFZ235 235CBL KZIZ - 3	- Engine code: 8140.67F - Engine code: 8140.07 - GBox: 2826.5 - GBox: 2819.5 - From chassis no.: 2926610
30-8 (14914111, 14914117, 14914211, 14914217, 14915111...) 30-8 V (14914111, 14914117, 14914211, 14914217...) 35-8 (14934104, 14934111, 14934204, 14934205, 14934211...) 35-10 (12974212, 12974217, 12974417) 40-10 4x4 (15214104, 15214111, 15214117, 15215111)	01.89 - 08.98 09.98 - 05.99 09.98 - 05.99 09.98 - 05.99 09.96 - 08.98 01.97 - 05.99	8140.23. 8140.63. 8140.67F. 8140.67F.3710 8140.67F.3711 8140.67F.3713 8140.67F.3721 8140.97.2781		2350.90.01 2353.20.00 2354.30.00 4500.40.00	235 10 MFZ235 235CBL KZIZ - 3	- Engine code: 8140.67F - Engine code: 8140.97 - Engine code: 8140.23 - GBox: 2826.5

Vehicle list

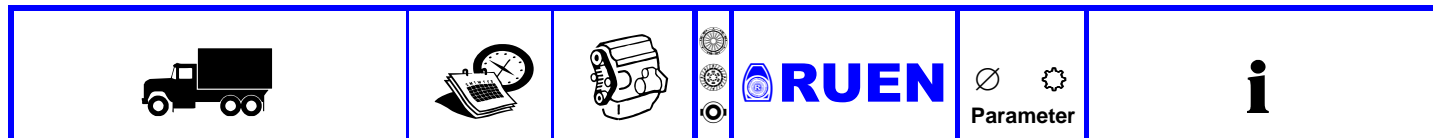

IVECO

DAILY II Box Body / Estate 01.89 - 05.99

35-10 (12974212, 12974217, 13014111, 13014131, 13014204...), 76kW 35-10 (12974212, 12974217, 13014111, 13014131, 13014204...), 80kW	01.89 - 08.98	8140.47R	2800.90.31	280 10	- Engine code: 8140.47R - GBox: 2826.5
	01.89 - 08.98	8140.47R.2790	2861.20.00	MFZ280	
			2867.30.00	280 VBL	
			4500.40.00	KZIZ - 3	
2650.90.15	265 10	- Engine code: 8140.47R - Engine code: 8140.27S - GBox: 2826.5 - Equipment Var: Euro2			
2658.20.00	MFZ265				
2678.30.00	265VTP				
4500.40.00	KZIZ - 3				
35-10 (15034111, 15034204, 15034211, 15034215, 15034217...)	01.96 - 05.99	8140.23.	2350.90.01	235 10	- Engine code: 8140.23 - GBox: 2826.5
			2353.20.00	MFZ235	
			2354.30.00	235CBL	
			4500.40.00	KZIZ - 3	
2650.90.15	265 10	- Engine code: 8140.23 - GBox: 2826.5			
2658.20.00	MFZ265				
2678.30.00	265VTP				
4500.40.00	KZIZ - 3				
35-12 (13114131, 13114204, 13114211, 13114212, 13114217...)	01.90 - 04.96	8140.47.2700 8140.47S	2650.90.15	265 10	- Engine code: 8140.47 - GBox: 2826.5
			2658.20.00	MFZ265	
			2678.30.00	265VTP	
			4500.40.00	KZIZ - 3	
2800.90.31	280 10	- Engine code: 8140.43 - GBox: 2826.5			
2861.20.00	MFZ280				
2867.30.00	280 VBL				
4500.40.00	KZIZ - 3				
40-10 V	01.90 - 04.96	8140.27.2720	2350.90.01	235 10	- From model year: 03/1990 - Engine code: 8140
			2353.20.00	MFZ235	
			2354.30.00	235CBL	
			4500.40.00	KZIZ - 3	
2650.90.01	265 10				
2651.20.00	MF265				
2655.30.00	265TB				
4502.40.00	KZI - 1				
45-10 V (13034204, 13034211, 13034212, 13034224...)	01.89 - 04.96	8140.27.2720	2350.90.01	235 10	- Engine code: 8140.27S - GBox: 2826.5 - From chassis no.: 5928513
			2353.20.00	MFZ235	
			2354.30.00	235CBL	
			4500.40.00	KZIZ - 3	
2650.90.01	265 10	- Engine code: 8140.27S - GBox: 2826.5 - To chassis no.: 5928512			
2651.20.00	MF265				
2655.30.00	265TB				
4502.40.00	KZI - 1				

Vehicle list

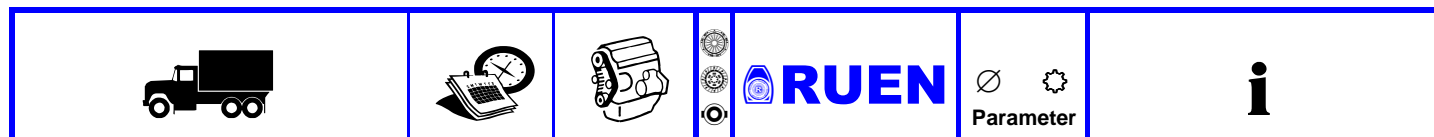

IVECO

DAILY II Box Body / Estate 01.89 - 05.99

49-10 V (13054204, 13054211, 13054212, 13054215...)	01.89 - 04.96	8140.27.2700 8140.47R.2790	2350.90.01	235 10 MFZ235 235CBL KZIZ - 3	- Engine code: 8140.23 - Engine code: 8140.27S - GBox: 2826.5 - From chassis no.: 5928513
			2353.20.00		
			2354.30.00 4500.40.00		
			2650.90.15	265 10 MFZ265 265VTP KZIZ - 3	- Engine code: 8140.27S - GBox: 2826.5 - Equipment Var: Euro2
			2658.20.00		
			2678.30.00 4500.40.00		
			2650.90.01	265 10 MF265 265TB KZI - 1	- Engine code: 8140.27S - GBox: 2826.5 - To chassis no.: 5928512
			2651.20.00		
			2655.30.00 4502.40.00		
49-12 V (13134124, 13134204, 13134211, 13134212...)	06.90 - 04.96	8140.47.2700 8140.47.2711	2650.90.15	265 10 MFZ265 265VTP KZIZ - 3	- Engine code: 8140.47 - GBox: 2826.5
59-12 V (13154404, 13154411, 13154412, 13154417...)	05.91 - 04.96	8140.47.2721 8140.47S	2658.20.00		
			2678.30.00 4500.40.00		
49-12 V (15154204, 15154211, 15154215, 15154217...)	05.96 - 05.99	8140.43.	2800.90.31	280 10 MFZ280 280 VBL KZIZ - 3	- Engine code: 8140.43 - GBox: 2826.5
59-12 V (15174404, 15174411, 15174415, 15174417)	05.96 - 05.99		2861.20.00		
			2867.30.00 4500.40.00		

DAILY II Dumptruck 01.89 - 05.99

35-8 K (14930304, 14931104, 14931111, 14931115...)	09.98 - 05.99	8140.23. 8140.63.	2350.90.01	235 10 MFZ235 235CBL KZIZ - 3	- Engine code: 8140.67 - Engine code: 8140.23 - GBox: 2826.5
			2353.20.00		
			2354.30.00 4500.40.00		
35-10 K (15030111, 15030211, 15030311, 15031111...)	01.97 - 05.99		2350.90.01	235 10 MFZ235 235CBL KZIZ - 3	- Engine code: 8140.27S - GBox: 2826.5 - From chassis no.: 5928513
			2353.20.00		
			2354.30.00 4500.40.00		
45-10 (13031204, 13031211, 13031212, 13031224, 13031231...)	01.92 - 04.96	8140.27.2720	2350.90.01	235 10 MFZ235 235CBL KZIZ - 3	- Engine code: 8140.27S - GBox: 2826.5 - From chassis no.: 5928513
			2353.20.00		
			2354.30.00 4500.40.00		
			2650.90.01	265 10 MF265 265TB KZI - 1	- Engine code: 8140.27S - GBox: 2826.5 - To chassis no.: 5928512
			2651.20.00		
			2655.30.00 4502.40.00		
49-10 K (13056212, 13056224, 13056231, 13056237...)	01.89 - 04.96	8140.27.2700 8140.47R.2790	2350.90.01	235 10 MFZ235 235CBL KZIZ - 3	- Engine code: 8140.27S - GBox: 2826.5 - From chassis no.: 5928513
			2353.20.00		
			2354.30.00 4500.40.00		
			2650.90.15	265 10 MFZ265 265VTP KZIZ - 3	- Engine code: 8140.27S - GBox: 2826.5 - Equipment Var: Euro2
			2658.20.00		
			2678.30.00 4500.40.00		
			2650.90.01	265 10 MF265 265TB KZI - 1	- Engine code: 8140.27S - GBox: 2826.5 - To chassis no.: 5928512
			2651.20.00		
			2655.30.00 4502.40.00		
49-10 K (15056204, 15056211, 15056304, 15056311)	05.96 - 05.99	8140.23.	2350.90.01	235 10 MFZ235 235CBL KZIZ - 3	- Engine code: 8140.23 - GBox: 2826.5
			2353.20.00		
			2354.30.00 4500.40.00		
			2650.90.15	265 10 MFZ265 265VTP KZIZ - 3	
			2658.20.00		
			2678.30.00 4500.40.00		

Vehicle list



IVECO

DAILY II Dumptruck 01.89 - 05.99

49-12 K (13136204, 13136211, 13136212, 13136224...) 59-12 K (13156211, 13156212, 13156231, 13156311...)	06.90 - 04.96 05.91 - 04.96	8140.47.2700 8140.47.2711 8140.47.2721	 	2650.90.15 2658.20.00 2678.30.00 4500.40.00	265 10 MFZ265 265VTP KZIZ - 3	- Engine code: 8140.47 - GBox: 2826.5
35-12 K (15130311, 15130411, 15131111, 15131204...) 59-12 K (15176211, 15176304, 15176311, 15176315...)	09.96 - 08.98 05.96 - 05.99	8140.43.	 	2800.90.31 2861.20.00 2867.30.00 4500.40.00	280 10 MFZ280 280 VBL KZIZ - 3	- Engine code: 8140.43 - GBox: 2826.5

DAILY II Platform/Chassis 01.89 - 05.99

30-8 (12910211, 12911111, 12911112, 12911117, 12911131...), 55kW 30-8 (12910211, 12911111, 12911112, 12911117, 12911131...), 60kW 35-8 (12931102, 12931104, 12931111, 12931112, 12931117...), 55kW 35-8 (12931102, 12931104, 12931111, 12931112, 12931117...), 60kW	01.92 - 08.98 01.92 - 08.98 01.89 - 08.98 01.89 - 08.98	8140.07.2700 8140.07.2712 8140.67F. 8140.67F.	 	2350.90.01 2353.20.00 2354.30.00 4500.40.00	235 10 MFZ235 235CBL KZIZ - 3	- Engine code: 8140.67F - Engine code: 8140.07 - GBox: 2826.5 - GBox: 2819.5 - From chassis no.: 2926610
				2400.90.01 2402.20.00 2402.30.00 4502.40.00	240 10 MFZ40 240PSD KZI - 1	- Engine code: 8140.07 - GBox: 2819.5 - To chassis no.: 2926609
30-8 (10011131, 10011132, 10011231, 10011232, 10011237...)	01.92 - 08.98 09.98 - 05.99	8140.63. 8140.67F. 8140.67F.3710 8140.67F.3711 8140.67F.3713 8140.67F.3721	 	2400.90.01 2402.20.00 2402.30.00 4502.40.00	240 10 MFZ40 240PSD KZI - 1	- Engine code: 8140.61 - GBox: 2815
				2350.90.01 2353.20.00 2354.30.00 4500.40.00	235 10 MFZ235 235CBL KZIZ - 3	- Engine code: 8140.67F - GBox: 2826.5
30-8 (14911111, 14911117, 14911211, 14911215, 14911217...) 35-8 (14930304, 14931104, 14931111, 14931115, 14931204...)	09.98 - 05.99 09.98 - 05.99	8140.63.	 	2350.90.01 2353.20.00 2354.30.00 4500.40.00	235 10 MFZ235 235CBL KZIZ - 3	- Engine code: 8140.67F - GBox: 2826.5
30-10	01.98 - 05.99	8140.23.	 	2350.90.01 2353.20.00 2354.30.00 4500.40.00	235 10 MFZ235 235CBL KZIZ - 3	
				2650.90.15 2658.20.00 2678.30.00 4500.40.00	265 10 MFZ265 265VTP KZIZ - 3	
35-10 (12971112, 12971212, 12971312, 12971317, 12976112...), 68kW 35-10 (12971112, 12971212, 12971312, 12971317, 12976112...), 76kW 49-10 (13050211, 13050231, 13050304, 13050311, 13050331...)	01.89 - 12.96 01.89 - 12.96 01.89 - 04.96	8140.27.2700 8140.47R.2790 8140.97.2781	 	2650.90.15 2658.20.00 2678.30.00 4500.40.00	265 10 MFZ265 265VTP KZIZ - 3	- Engine code: 8140.47R - Engine code: 8140.27S - GBox: 2826.5 - Equipment Var: Euro2
				2350.90.01 2353.20.00 2354.30.00 4500.40.00	235 10 MFZ235 235CBL KZIZ - 3	- Engine code: 8140.97 - Engine code: 8140.25S - Engine code: 8140.27S - GBox: 2826.5 - From chassis no.: 5928513
				2650.90.01 2651.20.00 2655.30.00 4502.40.00	265 10 MFZ265 265TB KZI - 1	- Engine code: 8140.27S - GBox: 2826.5 - To chassis no.: 5928512
35-10 (15030111, 15030211, 15030311, 15031111, 15031117...)	01.96 - 05.99	8140.23.		2350.90.01 2353.20.00 2354.30.00 4500.40.00	235 10 MFZ235 235CBL KZIZ - 3	- Engine code: 8140.23 - GBox: 2826.5

Vehicle list



IVECO

DAILY II Platform/Chassis 01.89 - 05.99

45-10 (13031204, 13031211, 13031212, 13031224, 13031231...)	01.89 - 04.96	8140.27.2720		2350.90.01	235 10 MFZ235 235CBL KZIZ - 3	- Engine code: 8140.27S - GBox: 2826.5 - From chassis no.: 5928513
				2353.20.00 2354.30.00 4500.40.00		
				2650.90.01	265 10 MF265 265TB KZI - 1	- Engine code: 8140.27S - GBox: 2826.5 - To chassis no.: 5928512
				2651.20.00 2655.30.00 4502.40.00		
35-10 35-12 (15130311, 15130411, 15131111, 15131204, 15131211...) 49-12 (15150211, 15150311, 15150404, 15150411, 15151204...) 59-12 (15170211, 15170304, 15170311, 15170504, 15170511...)	01.89 - 12.96	8140.43.		2800.90.31	280 10 MFZ280 280 VBL KZIZ - 3	- Engine code: 8140.47R - Engine code: 8140.43 - GBox: 2826.5
	05.96 - 05.99	8140.47R				
35-12 (13110131, 13110211, 13110231, 13110311, 13110312...) 49-12 (13130211, 13130231, 13130304, 13130311, 13130312...) 59-12 (13150204, 13150211, 13150231, 13150311, 13150312...)	01.90 - 04.96	8140.47.2700		2650.90.15	265 10 MFZ265 265VTP KZIZ - 3	- Engine code: 8140.47 - GBox: 2826.5
	06.90 - 04.96	8140.47.2711 8140.47.2721				
49-10 (15050304, 15050404, 15050411, 15051204, 15051211...)	05.96 - 05.99	8140.23.		2350.90.01	235 10 MFZ235 235CBL KZIZ - 3	- Engine code: 8140.23 - GBox: 2826.5
				2353.20.00 2354.30.00 4500.40.00		
				2650.90.15	265 10 MFZ265 265VTP KZIZ - 3	
				2658.20.00 2678.30.00 4500.40.00		

DAILY III Box Body / Estate 11.97 - 10.09

29 L 9 V 29 L 11 V	05.99 - 07.07	8140.43C		2350.90.01	235 10 MFZ235 235CBL KZIZ - 3	
	05.99 - 07.07	8140.63.				
35 S 9 V, 35 C 9 V 35 S 11 V, 35 C 11 V	05.99 - 07.07	8140.43C		2350.90.01	235 10 MFZ235 235CBL KZIZ - 3	- Engine code: 8140.43 - GBox: S5.200
	05.99 - 07.07	8140.63.				
29 L 10 V (ALJA43A2, ALJA42A2, ALJA41A2) 29 L 12 V (ALKA41A2, ALLA52A2, ALKA42A2) 29 L 14 35 S 10 (ANJA41A1, ANJA42A2, ANJA42AB, ANJA43A, ANJAV1A...) 35 C 12 V, 35 S 12 V (AGKA43A2, AGKB43A2, AGKB46A2...)	09.02 - 07.07	F1AE0481A		2350.90.01	235 10 MFZ235 235CBL KZIZ - 3	- GBox: ZF S5-200 - Engine code: F1AE0481
	09.02 - 07.07	F1AE0481B F1AE0481M				
35 S 15 V, 35 C 15 V (A6HCV3B2, A6HBV4B2, A6HC41B2...)	11.02 - 07.07	8140.43N		2800.90.31	280 10 MFZ280 280 VBL KZIZ - 3	- Engine code: 8140.43N - GBox: S6-300
35 C 17, 35 S 17	01.05 - 04.06	F1CE0481B		2800.90.31	280 10 MFZ280 280 VBL KZIZ - 3	- GBox: 6S-380 OD
50 C 11 50 C 13	05.99 - 07.07	8140.43C		2650.90.15	265 10 MFZ265 265VTP KZIZ - 3	
	05.99 - 07.07	8140.43S				

Vehicle list

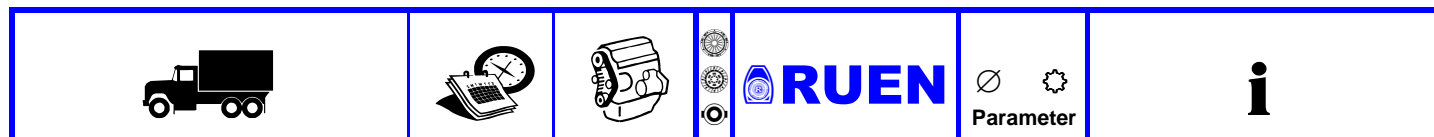

IVECO

DAILY III Platform/Chassis 03.98 - 10.09

29 L 9 29 L 11 35 C 9, 35 S 9	05.99 - 04.06 05.99 - 04.06 11.01 - 04.06	8140.43B 8140.43C 8140.43R 8140.63.	 	2350.90.01 2353.20.00 2354.30.00 4500.40.00	235 10 MFZ235 235CBL KZIZ - 3	
35 S 9,35 C 9 35 S 11,35 C 11 (A2FC13AA, A6FBU4AB, A2NB14A1, A2ND13A1...)	05.99 - 04.06 05.99 - 04.06	8140.43C 8140.63.	 	2350.90.01 2353.20.00 2354.30.00 4500.40.00	235 10 MFZ235 235CBL KZIZ - 3	- Engine code: 8140.43 - GBox: S5.200
29 L 10 (ALJAV1A1, ALJA41AA, ALJA41A1, AHJA64A1...) 29 L 12 (ALKA41A1, AHKA64A1, ALLA51A1) 35 C 10 V , 35 S 10 V (AMJA14A1, AMJA64A1, AMJA65A1...) 35 C 12 , 35 S 12 (AEKA14A1, AEKA14AA, AEKA64A1...)	09.02 - 04.06 09.02 - 04.06 09.02 - 04.06 09.02 - 04.06	F1AE0481A F1AE0481B	 	2350.90.01 2353.20.00 2354.30.00 4500.40.00	235 10 MFZ235 235CBL KZIZ - 3	- GBox: ZF S5-200 - Engine code: F1AE0481
29 L 14 (AHRA11C1B1, AHRA14C1B1, AHRA64C1B1)	11.05 - 04.06	F1AE0481M	 	2350.90.01 2353.20.00 2354.30.00 4500.40.00	235 10 MFZ235 235CBL KZIZ - 3	- GBox: ZF 5S-300
				2800.90.32 2861.20.00 2678.30.00 4500.40.00	280 10 MFZ280 265VTP KZIZ - 3	- GBox: ZF 5S-300
35 C 15 50 C 15 65 C 15	11.01 - 04.06 01.01 - 04.06 11.01 - 04.06	8140.43N	 	2800.90.31 2861.20.00 2867.30.00 4500.40.00	280 10 MFZ280 280 VBL KZIZ - 3	
35 C 17, 35 S 17	01.05 - 04.06	F1CE0481B		2800.90.31 2861.20.00 2867.30.00 4500.40.00	280 10 MFZ280 280 VBL KZIZ - 3	- GBox: F1AE0481
35 S 13,35 C 13 50 C 11 50 C 13	05.99 - 04.06 05.99 - 04.06 05.99 - 04.06	8140.43C 8140.43S	 	2650.90.15 2658.20.00 2678.30.00 4500.40.00	265 10 MFZ265 265VTP KZIZ - 3	

DAILY IV Box Body / Estate 05.06 - 03.12

40C14 GV, 40C14 GV/P 40C14 V, 40C14 V/P	07.07 - 08.11 07.07 - 08.11	F1CE044 1A F1CE3481LC	 	2800.90.31 2861.20.00 2867.30.00 4500.40.00	280 10 MFZ280 280 VBL KZIZ - 3	- GBox: 6S-400 OD
				2800.90.32 2861.20.00 2678.30.00 4500.40.00	280 10 MFZ280 265VTP KZIZ - 3	- GBox: 5S-300
29L10 V 29L12 V, 29L12 V/P 29L14 C, 29L14 C/P, 29L14 V, 29L14 V/P	05.06 - 08.11 05.06 - 08.11 05.06 - 08.11	F1AE0481FA F1AE0481GA F1AE0481HA	 	2350.90.01 2353.20.00 2354.30.00 4500.40.00	235 10 MFZ235 235CBL KZIZ - 3	- GBox: ZF 5S-300
				2800.90.32 2861.20.00 2678.30.00 4500.40.00	280 10 MFZ280 265VTP KZIZ - 3	- GBox: ZF 5S-300
35C12 V, 35C12 V/P, 35S12 V, 35S12 V/P	05.06 - 08.11	F1AE0481GA		2350.90.01 2353.20.00 2354.30.00 4500.40.00	235 10 MFZ235 235CBL KZIZ - 3	- GBox: ZF 5S-300

Vehicle list



IVECO

DAILY IV Box Body / Estate		05.06 - 03.12				
35C15 V, 35C15 V/P	05.06 - 08.11	F1CE0481FA	2800.90.31 2861.20.00 2867.30.00 4500.40.00	280 10 MFZ280 280 VBL KZIZ - 3	- GBox: 6S-400 OD - GBox: 6S-380 OD	
35C17 V, 35C17 V/P, 35S17 V, 35S17 V/P	07.07 - 08.11	F1CE0481HA				
35C18 V, 35C18 V/P, 35S18 V, 35S18 V/P	05.06 - 08.11					
40C17 V, 40C17 V/P	07.07 - 08.11					
50C17 V, 50C17 V/P	07.07 - 08.11					
65C17 V, 65C17 V/P	07.07 - 08.11					
70C14 V, 70C14 V/P	07.07 - 08.11	F1CE0481HA	2800.90.32 2861.20.00 2678.30.00 4500.40.00	280 10 MFZ280 265VTP KZIZ - 3	- GBox: ZF 6S-400 OD	
70C17V, 70C17 V/P	07.07 - 08.11	F1CE3481LC				
40C15 V, 40C15 V/P	05.06 - 08.11	F1CE0481FA	4500.40.00	KZIZ - 3	- Engine code: F1CE0481 - GBox: 6S-380A OD, 6S-400A OD	
40C18 V, 40C18 V/P	05.06 - 08.11	F1CE0481HA				
45C15 V	05.06 - 08.11	F1CE0481HC				
45C18	05.06 - 08.11					
50C15 V, 50C15 V/P	05.06 - 08.11					
50C18 V, 50C18 V/P	05.06 - 08.11					
60C15 V	05.06 - 08.11					
60C18	05.06 - 08.11					
65C15	05.06 - 08.11					
65C18	05.06 - 08.11					
DAILY IV Dumptruck		05.06 - 08.11				
35C10 K	05.06 - 08.11	F1AE0481FA				2350.90.01 2353.20.00 2354.30.00 4500.40.00
35C12	05.06 - 08.11	F1AE0481GA				
35C15	05.06 - 08.11	F1CE0481FA	2800.90.31 2861.20.00 2867.30.00 4500.40.00	280 10 MFZ280 280 VBL KZIZ - 3	- GBox: 6S-400 OD - GBox: 6S-380 OD	
35C17 K, 35C17 DK, 35S17 K, 35S17 DK	07.07 - 08.11	F1CE0481HA				
35C18	05.06 - 08.11					
40C17 K, 40C17 DK	07.07 - 08.11					
50C17 K, 50C17 DK	07.07 - 08.11					
65C17 K, 65C17 DK, 65C17KK	07.07 - 08.11					
40C14 K, 40C14 DK	07.07 - 08.11	F1CE3481LC	2800.90.31 2861.20.00 2867.30.00 4500.40.00	280 10 MFZ280 280 VBL KZIZ - 3	- GBox: 6S-400 OD	
						2800.90.32 2861.20.00 2678.30.00 4500.40.00
50C15	05.06 - 08.11	F1CE0481FA	4500.40.00	KZIZ - 3	- Engine code: F1CE0481 - GBox: 6S-380A OD, 6S-400A OD	
50C18	05.06 - 08.11	F1CE0481HA				
60C15	05.06 - 08.11	F1CE0481HC				
60C18	05.06 - 08.11					
70C14 K, 70C14 DK, 70C14 KK	07.07 - 08.11	F1CE0481HA	2800.90.32 2861.20.00 2678.30.00 4500.40.00	280 10 MFZ280 265VTP KZIZ - 3	- GBox: ZF 6S-400 OD	
70C17 K, 70C17 DK, 70C17 KK	07.07 - 08.11	F1CE3481LC				

Vehicle list



IVECO

DAILY IV Platform/Chassis 05.06 - 09.11

40C14 G, 40C14 G/P 40C14, 40C14 /P	07.07 - 08.11	F1CE0441A		2800.90.31	280 10	- GBox: 6S-400 OD
	07.07 - 08.11	F1CE3481LC		2861.20.00 2867.30.00 4500.40.00	MFZ280 280 VBL KZIZ - 3	
				2800.90.32	280 10	- GBox: 5S-300
				2861.20.00 2678.30.00 4500.40.00	MFZ280 265VTP KZIZ - 3	
29L10 29L12 29L14	05.06 - 08.11	F1AE0481FA		2350.90.01	235 10	- GBox: ZF 5S-300
	05.06 - 08.11	F1AE0481GA		2353.20.00 2354.30.00 4500.40.00	MFZ235 235CBL KZIZ - 3	
				2800.90.32	280 10	- GBox: ZF 5S-300
				2861.20.00 2678.30.00 4500.40.00	MFZ280 265VTP KZIZ - 3	
35C10, 35S10 35C12, 35S12	05.06 - 08.11	F1AE0481FA		2350.90.01	235 10	- GBox: ZF 5S-300
	05.06 - 08.11	F1AE0481GA		2353.20.00 2354.30.00 4500.40.00	MFZ235 235CBL KZIZ - 3	
35C15 35C17, 35C17 /P, 35S17, 35S17 /P, 35S17 D 35C18, 35S18 35S17 W, 35S17 WD 40C17, 40C17 /P 50C17, 50C17 /P 65C17, 65C17 /P	05.06 - 08.11	F1CE0481FA		2800.90.31	280 10	- GBox: 6S-400 OD
	07.07 - 08.11	F1CE0481HA		2861.20.00 2867.30.00 4500.40.00	MFZ280 280 VBL KZIZ - 3	- GBox: 6S-380 OD
	05.06 - 08.11					
	07.07 - 08.11					
	07.07 - 08.11					
	07.07 - 08.11					
40C15 40C18 45C15 45C18, 45C18 /P, 45C18 D, 45C18 D/P 50C15 50C18 60C15, 60C15 /P, 60C15 D, 60C15 D/P 60C18 65C15, 65C15 /P, 65C15 D, 65C15 D/P 65C18	05.06 - 08.11	F1CE0481FA		4500.40.00	KZIZ - 3	- Engine code: F1CE0481
	05.06 - 08.11	F1CE0481HA				- GBox: 6S-380A OD, 6S-400A OD
	05.06 - 08.11	F1CE0481HC				
	05.06 - 08.11					
	05.06 - 08.11					
	05.06 - 08.11					
	05.06 - 08.11					
	05.06 - 08.11					
	05.06 - 08.11					
05.06 - 08.11						
70C14, 70C14 /P 70C17, 70C17 /P	07.07 - 08.11	F1CE0481HA		2800.90.32	280 10	- GBox: ZF 6S-400 OD
	07.07 - 08.11	F1CE3481LC		2861.20.00 2678.30.00 4500.40.00	MFZ280 265VTP KZIZ - 3	

Daily 50...

50 NC 50-9 50-10	01.75 - - 02.82			2810.20.00	280	- Engine code: -Deutz
					H280K	- Engine code: 8340
50 F /50 F 10 55 F 9/55 F 10	01.78 - - 12.78			2810.30.00	280 10	- Engine code: -Deutz
					280CBL	- Engine code: 8340
55 NC 55-9 55-10	01.75 -					

Vehicle list

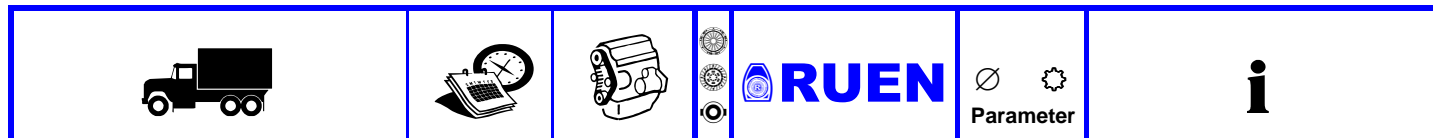

IVECO

Daily 50...

50-8				2514.20.00	250 H250K	- Engine code: 8040 - From model year: 09/1983
				2514.30.00	250 10 250CBL	- Engine code: 8040 - From model year: 09/1983
				6301.40.00	KZI - 2	- Engine code: 8040 - From model year: 09/1983
50-9 Zeta	01.87 -			2654.20.00	270 MF270	- Engine code: 8040
				2656.30.00	270 10 270CTB	- Engine code: 8040
50-10				2810.20.00	280 H280K	- From model year: 01/1978 - To model year: 12/1983
				2810.30.00	280 10 280CBL	- From model year: 01/1978 - To model year: 12/1983 - Engine code: 8340 - From model year: 09/1983
				6301.40.00	KZI - 2	- Engine code: 8340 - From model year: 09/1983
55-8	- 12.83			2514.20.00	250 H250K	- To model year: 02/1982
				2514.30.00	250 10 250CBL	- To model year: 02/1982
55-12 Turbo				2650.90.15	265 10	
				2658.20.00	MFZ265	
				2678.30.00	265VTP	
				4500.40.00	KZIZ - 3	

EuroCargo I-III 01.91 - 09.15

75 E 15 K D2HAD2A1, D2HAD2AD, D2HAD3AD, D2HAD3A1, D2HAD1A1	01.91 - 09.15	8060.25R.4200 LTC		3100.90.03	310 10	- Transmission Number: 2838.5
				3179.20.00	MFZ310	- Transmission Number: 2845.5
				3132.30.00	310GSB	- Transmission Number: 2845.6
				5501.40.00	KZISZ - 3	
75 E 15, 75 E 15 P, 80 E 15 D2HA12B1, D2HA14BD, D2HAC3A1, D2HAC3AD, D2HAC4A1, D2HAC4BD, D2HAC5E1, D2HAC6A1, D2HAC6AD, D2HAC6B1	01.91 - 09.15	8060.25R.4200 LTC		3100.90.03	310 10	- Transmission Number: 2845.5
				3179.20.00	MFZ310	- Transmission Number: 2845.6
				3132.30.00	310GSB	
				5501.40.00	KZISZ - 3	
80 E 15 K D3HAD1A1, D3HAD3A1, D3HAD3BD, D3HAD1B1, D3HAD3AD, D3HAD3B1, D3HAD2B1, D3HAD2A1, D3HAD2BD, D3HAD2AD, 7.49t	01.91 - 09.15	8060.25R.4200 LTC		3100.90.03	310 10	- Transmission Number: 2845.5
				3179.20.00	MFZ310	- Transmission Number: 2845.6
				3132.30.00	310GSB	
				5501.40.00	KZISZ - 3	
80 E 15 K D3HAD1A1, D3HAD3A1, D3HAD3BD, D3HAD1B1, D3HAD3AD, D3HAD3B1, D3HAD2B1, D3HAD2A1, D3HAD2BD, D3HAD2AD, 8.00t	01.91 - 09.15	8060.25R.4200 LTC		3100.90.03	310 10	- Transmission Number: 2845.5
				3179.20.00	MFZ310	- Transmission Number: 2845.6
				3132.30.00	310GSB	
				5501.40.00	KZISZ - 3	
80 E 15, 80 E 15 P D3HA12B1, D3HA13ED, D3HA14E1, D3HA15E1, D3HA15ED, D3HA33B1, D3HA33BD, D3HAC3BD, D3HAC4AD, D3HAC5E1, D3HAC6E1	01.91 - 09.15	8060.25V.4000		3100.90.03	310 10	- Transmission Number: 2855.6
				3179.20.00	MFZ310	
				3132.30.00	310GSB	
				5501.40.00	KZISZ - 3	
80 E 18, 80 E 18 P, 18 E 80 FP D3KAC4CD, D3KAC5C1, D3KAC6A1, D3KB15C1, D3KB15CD, D3KB16C1, D3KCC4A1, D3KHC5AD, D3KHC6D1, 7.49t	01.91 - 09.15	8060.25V.4000		3100.90.03	310 10	- Transmission Number: 2855.6
				3179.20.00	MFZ310	
				3132.30.00	310GSB	
				5501.40.00	KZISZ - 3	
80 E 18, 80 E 18 P, 18 E 80 FP D3KAC4CD, D3KAC5C1, D3KAC6A1, D3KB15C1, D3KB15CD, D3KB16C1, D3KCC4A1, D3KHC5AD, D3KHC6D1, 8.00t	01.91 - 09.15	8060.25V.4000		3100.90.03	310 10	- Transmission Number: 2855.6
				3179.20.00	MFZ310	
				3132.30.00	310GSB	
				5501.40.00	KZISZ - 3	
80 E 18 K D3KAD3A1, D3KAD3AD, D3KA31A1, D3KA32AD, D3KAD1A1, D3KAD2AD, D3KHD1A1, D3KA32A1, D3KA33A1, D3KHD2A1, D3KA33AD, D3KAD2A1, 7.49t	01.91 - 09.15	8060.25V.4000		3100.90.03	310 10	- Transmission Number: 2855.6
				3179.20.00	MFZ310	
				3132.30.00	310GSB	
				5501.40.00	KZISZ - 3	
80 E 18 K D3KAD3A1, D3KAD3AD, D3KA31A1, D3KA32AD, D3KAD1A1, D3KAD2AD, D3KHD1A1, D3KA32A1, D3KA33A1, D3KHD2A1, D3KA33AD, D3KAD2A1, 8.00t	01.91 - 09.15	8060.25V.4000		3100.90.03	310 10	- Transmission Number: 2855.6
				3179.20.00	MFZ310	
				3132.30.00	310GSB	
				5501.40.00	KZISZ - 3	

Vehicle list

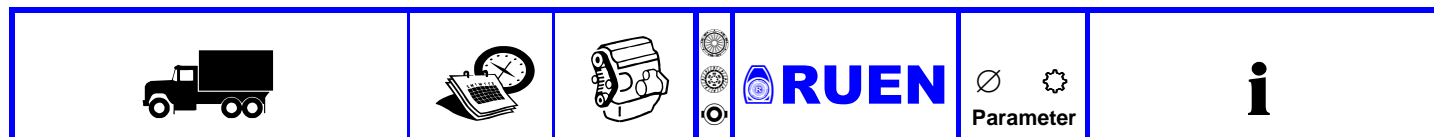

IVECO

EuroCargo I-III		01.91 - 09.15			
80 E 21, 80 E 21 P, 21 E 80 FP D3LAC3C1, D3LAC6A1, D3LB15C1, D3LBC4A1, D3LAC4A1, D3LAC6C1, D3LB15A1, D3LLC5D1, D3LA14C1, 8.00t 80 E 21, 80 E 21 P, 80 E 21 FP D3LAC3C1, D3LAC6A1, D3LB15C1, D3LBC4A1, D3LAC4A1, D3LAC6C1, D3LB15A1, D3LLC5D1, D3LA14C1, 7.49t	01.91 - 09.15 01.91 - 09.15	8060.45.4100 TCA 8060.45.4180	3300.90.01 3312.20.00 3315.30.00 5501.40.00	330 10 MFZ330 330GS KZISZ - 3	- Transmission Number: 2865.6
95 E 15 W D4HE12B1, D4HPC1B1, D4HE11A1, D4HE12AD, D4HPC1BD, D4HPC2B1, D4HE12A1, D4HPC2A1, D4HE11B1, D4HPC1A1, D4HE12BD	01.91 - 09.15	8060.25R.4750 8060.25R.4755 8060.25R.4760 8060.25R.4764 8060.45R.5050 8060.45R.5051	3100.90.03 3179.20.00 3132.30.00 5501.40.00	310 10 MFZ310 310GSB KZISZ - 3	- Transmission Number: 2845.5 - Transmission Number: 2845.6
95 E 21 W D4LE11A1, D4LPC1C1, D4LPC2AD, D4LPC2A1, D4LE11AD, D4LPC1AD, D4LPC2C1, D4LE12A1, D4LE12AD, D4LPC1A1	01.91 - 09.15	8060.45.4700 8060.45.4702 8060.45.4704 8060.45.4706 8060.45.4708 8060.45.5250 8060.45.5251 8060.45.5255	3300.90.01 3312.20.00 3315.30.00 5501.40.00	330 10 MFZ330 330GS KZISZ - 3	- To chassis no.: 2253628 - Transmission Number: 2865.6 - Transmission Number: S6-36 - Transmission Number: S6-36/2-5
100 E 15 K D4HA31B1, D4HAD3A1, D4HAD3AD, D4HAD3BD, D4HAD1A1, D4HAD2A1, D4HAD2B1, D4HAD2AD, D4HAD2BD, D4HAD3B1, D4HA33B1 100 E 15, 100 E 15 P D4HA13B1, D4HA15B1, D4HA15E1, D4HAC4E1, D4HAC5A1, D4HHC2BD, D4HHC4A1, D4HHC5BD, D4HHC6E1, D4HA16B1	01.91 - 09.15 01.91 - 09.15	8060.25R.4200 LTC 8060.45R.5000 8060.45R.5001 8060.45R.5003 8060.45R.5005	3100.90.03 3179.20.00 3132.30.00 5501.40.00	310 10 MFZ310 310GSB KZISZ - 3	- Transmission Number: 2845.5 - Transmission Number: 2845.6
100 E 18 K D4KAD2AD, D4KHD1A1, D4KHD2A1, D4KA32A1, D4KAD2A1, D4KA31A1, D4KA33A1, D4KAD1A1, D4KAD3A1, D4KAD3AD 100 E 18, 100 E 18 P D4KAC4C1, D4KAC4CD, D4KAC5CD, D4KB14C1, D4KAC2A1, D4KAC2AD, D4KAC5AD, D4KAC6CD, D4KB16C1, D4KHC7A1	01.91 - 09.15 01.91 - 09.15	8060.25V.4000	3100.90.03 3179.20.00 3132.30.00 5501.40.00	310 10 MFZ310 310GSB KZISZ - 3	- Transmission Number: 2855.6
100 E 21, 100 E 21 P D4LAC4C1, D4LB15A1, D4LBC4C1, D4LHC4A1, D4LHC5A1, D4LA15A1, D4LA15C1, D4LAC2A1, D4LB14A1, D4LHC3A1	01.91 - 09.15	8060.45.4100 TCA 8060.45.4180	3300.90.01 3312.20.00 3315.30.00 5501.40.00	330 10 MFZ330 330GS KZISZ - 3	- Transmission Number: 2865.6
120 E 15 E0BA16B1, E0BAC1B1, E0BBC6AD, E0HHC5BD, E0BA17B1, E0BAC4ED, E0BAC6B1, E0BBC3D1, E0HHC5A1, E0HHC9BD, E0BA15B1, E0BAC2A1 120 E 15 K E0BAD1AD, E0BAD1BD, E0BAD1A1, E0BAD1B1, E0BAD2BD, E0BAD2A1, E0BAD2B1, E0BAD2AD	01.91 - 09.15 01.91 - 09.15	8060.25R.4200 8060.25R.4280	3100.90.03 3179.20.00 3132.30.00 5501.40.00	310 10 MFZ310 310GSB KZISZ - 3	- Transmission Number: 2845.5 - Transmission Number: 2845.6
120 E 18 K E0CA32B1, E0CAD1B1, E0CAD1A1, E0CA31B1, E0CAD2A1 120 E 18, 120 E 18 P, 120 E 18 H E0CA13E1, E0CA14B1, E0CA15E1, E0CA16B1, E0CA16BD, E0CA17E1, E0CAC3B1, E0CAC4B1, E0CAC5E1	01.91 - 09.15 01.91 - 09.15	8060.25V.4080 8060.45B.5100	3100.90.03 3179.20.00 3132.30.00 5501.40.00	310 10 MFZ310 310GSB KZISZ - 3	- Transmission Number: 2855.6 - Transmission Number: 2870.9
120 E 23, 120 E 23 P, 120 E 23 FP, 120 E 23 H E0DA13B1, E0DAC2A1, E0DAC2E1, E0DAC6A1, E0DBC3A1, E0DBC3B1, E0DBC7D1, E0MHC5E1	01.91 - 09.15	8060.45.6090 8060.45S.6800 8060.45S.7200	3300.90.01 3312.20.00 3315.30.00 5501.40.00	330 10 MFZ330 330GS KZISZ - 3	- Transmission Number: 2865.6 - Transmission Number: 2870.9

Vehicle list



IVECO

EuroCargo I-III		01.91 - 09.15				
130 E 15 E1HHC7AD, E5BAC2A1, E5BAC2AD, E5BAC2E1, E5BAC3A1, E5BAC3AD, E5BBC5AD, E5BAC5AD, E5BAC5DD, E5BBC3AD, E1HHC2AD, E1HHC7A1	01.91 - 09.15	8060.25R.4280 8060.25V.4080		3100.90.03 3179.20.00 3132.30.00 5501.40.00	310 10 MFZ310 310GSB KZISZ - 3	- Transmission Number: 2845.6 - Transmission Number: 2870.9 - Transmission Number: 2855.6
130 E 15 K E5BAD2AD, E5BAD1AD, E5BAD2A1, E5BAD1A1	01.91 - 09.15					
130 E 18 E1KHC6A1, E1KHC6B1, E1KHC7A1, E1KHC9A1, E5CA14E1, E5CA17B1, E5CAC2D1, E5CAC3E1, E5CAC4A1, E5CAC4B1, E5CAC6DD, E5CAC7E1	01.91 - 09.15					
130 E 18 K E5CAD1A1, E5CAD2A1	01.91 - 09.15					
130 E 23 E1MHC4A1, E1MHC6B1, E1MLC8E1, E5DAC5E1, E5DAC7A1, E5DAC7E1, E5DBC3E1, E5DC16BD, E1MHC8E1, E1MLC5B1, E5DAC1B1, E5DAC3B1	01.91 - 09.15	8060.45.6090 8060.45S.6000		3300.90.01 3312.20.00 3315.30.00 5501.40.00	330 10 MFZ330 330GS KZISZ - 3	- To chassis no.: 2253628 - Transmission Number: ZF S6.36 - Transmission Number: 2865.6 - Transmission Number: 2870.9
				3100.90.03 3179.20.00 3132.30.00 5501.40.00	310 10 MFZ310 310GSB KZISZ - 3	- Transmission Number: 2865.6 - Transmission Number: 2870.9
135 E 18 W E3KPC1A1, E3KPC2AD, E3KPC3AD, E3KPC2A1, E3KPC3A1	01.91 - 09.15	8060.25V.4800		3100.90.03 3179.20.00 3132.30.00 5501.40.00	310 10 MFZ310 310GSB KZISZ - 3	- Transmission Number: 2865.6
135 E 18 WR E1CE13A1, E1CE13AD, E1CE11A1, E1CE12AD, E1CE11AD, E1CE12A1	01.91 - 09.15					
135 E 23 W E3MPC1A1, E3MPC1AD, E3MPC3A1, E3MPC3AD, E3MPC2C1, E3MPC2A1	01.91 - 09.15	8060.45S TCA		3300.90.01 3312.20.00 3315.30.00 5501.40.00	330 10 MFZ330 330GS KZISZ - 3	- To chassis no.: 2253628 - Transmission Number: 2865.6 - Transmission Number: S6-36/2-5
135 E 23 WR E1DE13A1, E1DE11AD, E1DE12A1, E1DE12AD, E1DE13AD, E1DE11A1	01.91 - 09.15	8060.45S TCA		3300.90.01 3312.20.00 3315.30.00 5501.40.00	330 10 MFZ330 330GS KZISZ - 3	- To chassis no.: 2253628 - Transmission Number: 2865.6
150 E 15 E2BAC2DD, E2BAC6BD, E2HHC7AD, E2BAC2AD, E2BAC4A1, E2BAC5A1, E2BAC2ED, E2BAC3A1, E2BAC6A1, E2BAC7A1, E2BAC7DD, E2BAC4AD	01.91 - 09.15	8060.25R.4280		3100.90.03 3179.20.00 3132.30.00 5501.40.00	310 10 MFZ310 310GSB KZISZ - 3	- Transmission Number: 2845.6 - Transmission Number: 2870.9
150 E 15 K E2BAD1AD, E2BAD2A1, E2BAD1A1	01.91 - 09.15	8060.25R.4280		3100.90.03 3179.20.00 3132.30.00 5501.40.00	310 10 MFZ310 310GSB KZISZ - 3	- Transmission Number: 2845.6
150 E 18 K E2CA32B1, E2CAD2A1, E2CA31B1, E2CAD1B1, E2CAD2B1, E2CAD1A1	01.91 - 09.15	8060.25V.4000 8060.25V.4080 8060.45B		3100.90.03 3179.20.00 3132.30.00 5501.40.00	310 10 MFZ310 310GSB KZISZ - 3	- Transmission Number: 2865.6 - Transmission Number: 2870.9
150 E 18, 150 E 18 P E2CA15E1, E2CA17E1, E2CAC1AD, E2CAC1BD, E2CAC2BD, E2CAC3AD, E2CAC3D1, E2CAC4AD, E2CAC4B1, E2CAC5AD	01.91 - 09.15					
150 E 23, 150 E 23 P, 150 E 23 FP E2DA16B1, E2DA16E1, E2DAC1A1, E2DAC2A1, E2DB17B1, E2DB17E1, E2DBC5E1, E2DCC5E1, E2MMC9E1	01.91 - 09.15	8060.45.6090 8060.45S.6800		3300.90.01 3312.20.00 3315.30.00 5501.40.00	330 10 MFZ330 330GS KZISZ - 3	- To chassis no.: 2253628 - Transmission Number: ZF S6.36 - Transmission Number: 2865.6 - Transmission Number: 2870.9 - Transmission Number: 2870S.9
				3100.90.03 3179.20.00 3132.30.00 5501.40.00	310 10 MFZ310 310GSB KZISZ - 3	- Transmission Number: 2870.9

Vehicle list



IVECO

EuroCargo I-III		01.91 - 09.15				
170 E 18 K, 180 E 18 K F0AAD2A1, F0AAD3A1, F0AAD3AD, F0AAD3B1, F0AAD2AD, F0AAD2BD, F0AAD2B1, F0AAD3BD 170 E 18, 180 E 18 F0AAC3ED, F0AAC4BD, F0AAC6D1, F0AAC7A1, F0AAC7B1, F0AAC7E1, F0AAC8AD, F0AAC9DD, F0AAC9ED, F0ABC5DD, F0ABC7ED	01.91 - 09.15 01.91 - 09.15	8060.25V.4800	 	3100.90.03 3179.20.00 3132.30.00 5501.40.00	310 10 MFZ310 310GSB KZISZ - 3	- Transmission Number: 2865.6 - Transmission Number: 2870.9
170 E 23 K, 180 E 23 K F0BAD2B1, F0BAD3B1, F0BAD2A1, F0BAD2BD, F0BAD3A1, F0BAD3BD 170 E 23, 180 E 23 F0BA17E1, F0BAC3A1, F0BAC3B1, F0BAC7D1, F0BAC8BD, F0MHC3A1, F0BA15B1, F0BA17B1, F0BAC2B1, F0BAC3BD, F0BAC6B1	01.91 - 09.15 01.91 - 09.15	8060.45S TCA	 	3300.90.01 3312.20.00 3315.30.00 5501.40.00	330 10 MFZ330 330GS KZISZ - 3	- To chassis no.: 2253628 - Transmission Number: 2865.6 - Transmission Number: 2870.9
180 E 21 T D3LB22C1, D3LB22A1, D3LA22A1, D3LA22C1, D3LA22CD, D3LA22AD	01.91 - 09.15	8060.45.4100 TCA	 	3300.90.01 3312.20.00 3315.30.00 5501.40.00	330 10 MFZ330 330GS KZISZ - 3	- Transmission Number: 2865.6
260 E 23 T E0DB21BD, E0DB21E1, E0MH22B1, E0DA21BD, E0DA21ED, E0DB21B1, E0ML22B1, E0ML22BD, E0DA21B1, E0DA21E1, E0ML22E1 280 E 23 T E2DB22E1, E2DA21B1, E2DA22E1, E2DA21BD, E2DA22ED, E2DB21B1, E2DA22BD	01.91 - 09.15 01.91 - 09.15	8060.45S TCA 8060.45S.6000	 	3300.90.01 3312.20.00 3315.30.00 5501.40.00	330 10 MFZ330 330GS KZISZ - 3	- Transmission Number: 2870.9
EuroCargo Euro 6			 	3620.90.50 3607.20.00 3608.30.00 8514.40.00	362 10 MF362 362WGTZ KZI - 4,5	- Engine code: Tetcor 4 - Equipment Var: 160/186 PS - GBox: 6 AS 700 TO, 6 S 700 TO
			 	3620.90.51 3607.20.00 3609.30.00 8514.40.00	362 10 MF362 362 WGTZ KZI - 4,5	- Engine code: Tetcor 4 - Equipment Var: 206 PS - GBox: 6 AS 800 TO, 6 S 800 TO
				3953.20.00	395 MF395	- Engine code: Tetcor 6 - Equipment Var: 220/250 PS - GBox: 6 AS 800 TO, 6 S 800 TO - Equipment Var: 280 PS - GBox: 6 AS 1000 TO, 6 S 1000TO
				8541.40.00	KZIS-4	- Engine code: Tetcor 6 - Equipment Var: 220/250 PS - GBox: 6 AS 800 TO, 6 S 800 TO - Equipment Var: 280 PS - GBox: 6 AS 1000 TO, 6 S 1000TO
				8936.40.00	KZISZ - 5	- Engine code: Tetcor 6 - Equipment Var: 320 PS - GBox: 12 AS 1210 TO

Vehicle list



IVECO

EuroCargo I-III 01.91 - 09.15

60 E 10 D0BAC4A1, D0BAC2B1, D0BAC2A1, D0BAC3B1, D0BAC3A1, D0BAC1A1, D0BAC4B1, D0BAC1B1	01.91 - 09.15	8040.25B.4200 8040.25X.4000		2858.30.00	280 10 280GTZ	- Engine code: 8040 - To chassis no.: 21801116
60 E 12 D0DAC3A1, D0DAC2BD, D0DAC3AD, D0DAC1B1, D0DAC3BD, D0DAC1AD, D0DAC3B1, D0DAC2AD, D0DAC2A1, D0DAC4A1, D0DAC4B1, D0DAC6AD	01.91 - 09.15	8040.45.4000 8040.45.4180		5501.40.00	KZISZ - 3	- Engine code: 8040 - To chassis no.: 21801116
60 E 14 K D0EAD2A1, D0EAD1A1	01.91 - 09.15					
60 E 14, 60 E 14 P D0EAC1AD, D0EAC3DD, D0EAC6B1, D0EBC3B1, D0EAC2B1, D0EAC3B1, D0EAC6A1, D0EBC6B1, D0EAC1B1, D0EAC4B1	01.91 - 09.15					
65 E 10 D1BAC2B1, D1BAC1B1, D1BAC3B1, D1BAC4A1, D1BAC2A1, D1BAC1A1, D1BAC3A1, D1BAC4B1	01.91 - 09.15					
65 E 10 K D1BAD2A1, D1BAD1A1	01.91 - 09.15					
65 E 12 K D1DAD1AD, D1DAD2A1, D1DAD2AD, D1DAD1A1	01.91 - 09.15					
65 E 12, 65 E 12 P D1DA12E1, D1DAC1AD, D1DAC3AD, D1DAC6D1, D1DDC4B5, D1DA16B1, D1DAC3A1, D1DDC4D5, D1DHC2A1, D1DHC4A1, D1DHC4B1	01.91 - 09.15					
65 E 14 K D1EAD2AD, D1EHD1A1, D1EAD2A1, D1EHD2A1, D1EAD1A1	01.91 - 09.15					
65 E 14, 65 E 14 P D1EAC2AD, D1EAC3D1, D1EHC4AD, D1ELC5E1, D1EA13B1, D1EAC4A1, D1EAC4B1, D1EAC4D1, D1EHC1B1, D1EHC5A1, D1EAC2B1	01.91 - 09.15					
75 E 12 K D2DAD2AD, D2DAD3AD	01.91 - 09.15					
75 E 12, 75 E 12 P D2DAC2A1, D2DAC2B1, D2DAC3A1, D2DAC3DD, D2DAC4AD, D2DAC4BD, D2DBC5A1, D2DHC4A1, D2DHC6E1, D2DAC2AD, D2DAC4A1	01.91 - 09.15					
75 E 14 K D2EAD2AD, D2EAD3AD	01.91 - 09.15					
75 E 14, 75 E 14 P D2EAC2B1, D2EAC4AD, D2EAC4B1, D2EBC3E1, D2EHC1A1, D2EHC5B1, D2EHC7B1, D2ELC4A1, D2EAC5A1, D2EAC6AD, D2EBC3A1	01.91 - 09.15					

Vehicle list



IVECO

EuroCargo I-III 01.91 - 09.15

75 E 14 K tector	09.06 - 09.15	F4AE3481A	3620.90.51	362 10	- GBox: 6 AS 800 TO, 6 S 800 TO
75 E 14 tector, 75 E 14 P tector	09.06 - 09.15	F4AE3481B	3607.20.00	MF362	
BJMAC4D1, BJMAC4DA, BJMAC6D1,		F4AE3481C	3609.30.00	362 WGTZ	
BJMAC7D1, BJMAC5D1, BJMAC6D2,		F4AE3481D	8514.40.00	KZI - 4,5	
BJMAC7D2, BJMAC3D1, BJMAC4DB		F4AE3681B	3620.90.52	362 10	- GBox: ZF 6AS 700 T0
75 E 16 K tector	09.06 - 09.15		3607.20.00	MF362	
75 E 16 tector, 75 E 16 P tector	09.06 - 09.15		3607.30.00	362WGTZ	
BJNAC3DA, BJNAC4D2, BJNAC5D2,			8514.40.00	KZI - 4,5	
BJNBC2D1, BJNBC4DB, BJNBC5D1,					
BJNBC5DB, BJNBC7D2, BJNAC2DA					
100 E 18 K tector	09.06 - 09.15				
100 E 18 tector, 100 E 18 P tector, 100	09.06 - 09.15				
E 18 FP tector					
100 E 22 tector, 100 E 22 P tector, 100	09.06 - 09.15				
E 22 FP tector					
100 E 22 W tector, 100 E 22 WS tector	09.06 - 09.15				
BMSEC1D5, BMSEC1E5, BMSEC1DE,					
BMSEC2DE, BMSEC2D5, BMSEC2E5					
120 E 18 K tector, 120 E 18 DK tector	09.06 - 09.15				
120 E 22 D tector, 120 E 22 P tector,	09.06 - 09.15				
120 E 22 FP tector					
120 E 22 K tector	09.06 - 09.15				
140 E 18 K tector, 140 E 18 DK tector	09.06 - 09.15				
140 E 18 tector, 140 E 18 P tector, 140	09.06 - 09.15				
E 18 D FP tector					
140 E 22 K tector	09.06 - 09.15				
140 E 22 tector, 140 E 22 P tector, 140	09.06 - 09.15				
E 22 D FP tector					
150 E 22 K tector	09.06 - 09.15				
150 E 22 tector, 150 E 22 P tector, 150	09.06 - 09.15				
E 22 FP tector					
160 E 18 K tector	09.06 - 09.15				
160 E 18 tector, 160 E 18 P tector	09.06 - 09.15				
160 E 22 K tector	09.06 - 09.15				
160 E 22 tector, 160 E 22 P tector	09.06 - 09.15				

Vehicle list



IVECO

EuroCargo I-III 01.91 - 09.15

80 E 17 K, 80 E 17 DK tector, 80 E 18 K tector	09.00 - 09.15	F4AE0481A	 5501.40.00	KZISZ - 3	<ul style="list-style-type: none"> - From model year: 06/2003 - Engine code: Tector 4 F4A E0481A - Transmission Number: 2870.9 - GBox: Iveco 9-Gear - From model year: 11/2000 - Engine code: Tector 6 F4A E0681E - Engine code: F4AE0681
80 E 17, 80 E 17 D tector, 80 E 17 DP tector, 80 E 18 tector DKPAC3D1, DKPAC4D1, DKPAC4D2, DKPAC4G2, DKPAC4GA, DKPAC5GB	09.00 - 09.15	F4AE0681D F4AE0681E F4AE3481B F4AE3681B			
80 E 18 K tector, 80 E 18 DK tector	09.00 - 09.15				
80 E 18 tector, 80 E 18 D tector, 80 E 18 DP tector DKRBE7DD, DKRCC7D2, DKRCC7GB, DKRAC2D1, DKRAC3D1, DKRAC4D1, DKRAC6DA	09.00 - 09.15				
80 E 21 K, 80 E 21 DK tector, 80 E 22 K tector	09.00 - 09.15				
80 E 21, 80 E 21 D tector, 80 E 21 DP tector, 80 E 22 tector DKSAC3GA, DKSAC5D1, DKSAC6D1, DKSAC6DB, DKSAC7G2, DKSAE2G4	09.00 - 09.15				
90 E 17 K tector, 90 E 17 DK tector	09.00 - 09.15				
90 E 17, 90 E 17D tector, 90 E 17 DP tector, 90 E 18 tector BLRAC3DA, BLRAC4D2, BLRAC4DA, BLRAC4G2, BLRAC5GB, BLRAC6D2, BLRAC7B2	09.00 - 09.15				
90 E 18 K tector, 90 E 18 DK tector	09.00 - 09.15				
90 E 18 tector, 90 E 18 D tector, 90 E 18 DP tector DKRAC2D1, DKRAC3D1, DKRAC4D1, DKRAC6DA, DKRAC6GB, DKRAC7DA, DKRAC7GA	09.00 - 09.15				
90 E 21 K tector, 90 E 21 DK tector	09.00 - 09.15				
90 E 21, 90 E 21 D tector, 90 E 21 DP tector, 90 E 22 tector DKSAC3GA, DKSAC5D1, DKSAC6D1, DKSAC6DB, DKSAC7G2, DKSAE2G4	09.00 - 09.15				

Vehicle list

					
---	---	---	--	---	---

IVECO

EuroCargo I-III

01.91 - 09.15

100 E 18 K tector, 100 E 18 DK tector D4RAC4D2, D4RAC5D1, D4RBC4D1, D4RBC5D2, D4RBC5G2, D4RBC6D2, D4RBE6D3, D4RCC6D2, D4RCC7G2	09.00 - 09.15	F4AE0681C F4AE0681D F4AE0681E	5501.40.00	KZISZ - 3	<ul style="list-style-type: none"> - From model year: 06/2003 - Engine code: Tector 4 F4A E0481A - Transmission Number: 2870.9 - GBox: Iveco 9-Gear
100 E 18 tector, 100 E 18 P tector, 100 E 18 FP tector D4RAC4D2, D4RAC5D1, D4RBC4D1, D4RBC5D2, D4RBC5G2, D4RBC6D2, D4RBE6D3	09.00 - 09.15	F4AE3681B F4AE3681C			
100 E 18 W tector, 100 E 18 WS tector D4RAC4D2, D4RAC5D1, D4RBC4D1, D4RBC5D2, D4RBC5G2, D4RBC6D2, D4RBE6D3, D4RCC6D2, D4RCC7G2	09.00 - 09.15				<ul style="list-style-type: none"> - From model year: 11/2000 - Engine code: Tector 6 F4A E0681E - Engine code: F4AE0681
100 E 21 K tector, 100 E 21 DK tector D4SAC2D1, D4SAC2G1, D4SAC4DA, D4SBC2D1, D4SBC3G1, D4SBC7G1, D4SCC6DA, D4SAC1D1, D4SAC7G1	09.00 - 09.15				
100 E 21 W tector, 100 E 21 WS tector D4SAC2D1, D4SAC2G1, D4SAC4DA, D4SBC2D1, D4SBC3G1, D4SBC7G1, D4SCC6DA, D4SAC1D1, D4SAC7G1	09.00 - 09.15				
100 E 21, 100 E 21 DP tector, 100 E 22 tector BLSAC2G1, BLSAC4D2, BLSAC4DA, BLSAC4G2, BLSAC4GB, BLSAC6G2, BLSAE5GD, BLSBC4D1	09.00 - 09.15				
120 E 18 K tector, 120 E 18 DK tector	09.00 - 09.15				
120 E 18 tector, 120 E 18 D tector, 120 E 18 DP tector EKRAC5G1, EKRAC7DA, EKRAC9DA, EKRACBGB, EKRAE4D4, EKRAE4GD, EKRAE5DD	09.00 - 09.15				
120 EL 21, 120 EL 21 P tector, 120 E 22, 120 EL 22 tector EJSAC3G1, EJSAC5G2, EJSBC3DA, EJSBC3GA, EJSBC7G1, EKSAC4G1, EKSAC5GA	09.00 - 09.15				
130 E 18 K tector, 130 E 18 DK tector E4RAC2DA, E4RAC5G1, E4RAC6D1, E4RAC8DA, E4RAC8DB, E4RAC9DA, E4RACBGB, E4RBC2G1, E4RBC8D1	09.00 - 09.15				
130 E 18 tector, 130 E 18 D tector, 130 E 18 DP tector E4RAC2DA, E4RAC5G1, E4RAC6D1, E4RAC8DA, E4RAC8DB, E4RAC9DA, E4RACBGB	09.00 - 09.15				
140 E 18 W tector ENREC1D1, ENREC1DA, ENREC2D1, ENREC3DA, ENREC2DA, ENREC3D1	09.00 - 09.15				
150 E 18 K tector E6RAC2GA, E6RAC4D1, E6RAC7G2, E6RACBD1, E6RBC2G1, E6RAC2D1, E6RAC4G1, E6RAC4GA, E6RAC5D1, E6RAC5GA, E6RAC8D1	09.00 - 09.15				
150 E 18 tector E6RAC2GA, E6RAC4D1, E6RAC7G2, E6RACBD1, E6RBC2G1, E6RAC2D1, E6RAC4G1, E6RAC4GA, E6RAC5D1, E6RAC5GA, E6RAC8D1	09.00 - 09.15				
180 E 21 K tector F0SAC5DA, F0SAC7DA, F0SAC9D1, F0SAC9DA, F0SAC9G2, F0SBC6G1, F0SAC6G1, F0SACBDA, F0SBCAGA, F0SAC8DA, F0SACBDB	09.00 - 09.15				
180 E 21 tector F0SAC5DA, F0SAC7DA, F0SAC9D1, F0SAC9DA, F0SAC9G2, F0SBC6G1, FJSAC5T1, FJSAC6G1, FJSAC7D1, FJSAC7DB, FJSACBD2	09.00 - 09.15				

Vehicle list



IVECO

EuroCargo I-III 01.91 - 09.15

110 E 25 W tector	05.06 - 09.15	F4AE0681A		3953.20.00	395 MF395	- GBox: 6AS800/6AS1000
110 E 25 WS tector	05.06 - 09.15	F4AE0681B				
140 E 24 K tector	09.00 - 09.15	F4AE3681A		8514.40.00	KZI - 4,5	- GBox: 6AS800/6AS1000
140 E 24 tector, 14 E 24 P tector, 140 E 24 FP tector EQTBC2D1, EQTBC6D2, EQTBC8D2, EQTCC5D1, EQTCC8D1, EQTCC8D2, EQTCCBG1	09.00 - 09.15	F4AE3681D F4AE3681E				
140 E 28 W tector, 140 E 28 WS tector	09.06 - 09.15					
150 E 28 WS tector	09.06 - 09.15					
150 E 30 K tector	09.06 - 09.15					
150 E 30 tector, 150 E 30 P tector, 150 E 30 FP tector	09.06 - 09.15					
160 E 28 K tector	09.06 - 09.15					
160 E 30 K tector	09.06 - 09.15					
160 E 30 tector, 160 E 30 P tector	09.06 - 09.15					
180 E 30 K tector	09.06 - 09.15					
180 E 30 tector, 180 E 30 P tector	08.06 - 09.15					
190 E 25 tector, 190 E 25 P tector	05.08 - 09.15					
190 E 30 tector, 190 E 30 P tector	05.08 - 09.15					
230 E 30 tector	02.08 - 09.15					
120 E 24 K tector, 120 E 24 DK tector	09.00 - 09.15	F4AE0681B		38109.30.00	380 10 380GTZ	- Transmission Number: 2895.9 - GBox: Iveco 9-Gear - Engine code: F4AE0681
120 E 24, 120 E 24 DP tector, 120 E 25 FP tector CKTAC2DA, CKTAC4G1, CKTAC4G2, CKTAC7G1, CKTAC7GA, CKTAC9D1, CKTAC9G1, EKTAC5F1	09.00 - 09.15	F4AE3681D		8919.40.00	KZISZ - 5	- Transmission Number: 2895.9 - GBox: Iveco 9-Gear - Engine code: F4AE0681
130 E 24 tector, 130 E 24 D tector, 130 E 24 DP tector E4TAC6G2, E4TAC7G2, E4TACBG1, E4TAE6G3, E4TBC7G1, E4TBC9G2, E4TCC6G1	09.00 - 09.15			3953.20.00	395 MF395	- GBox: 6AS800/6AS1000
150 E 24 tector, 150 E 25 tector CMTAC5G2, CMTAC6G2, CMTAC7G1, CMTAC8D2, CMTAC9D1, E6TAC2F1, E6TAC4T1, E6TAC6FA, E6TAC8G1	09.00 - 09.15			8514.40.00	KZI - 4,5	- GBox: 6AS800/6AS1000

Vehicle list

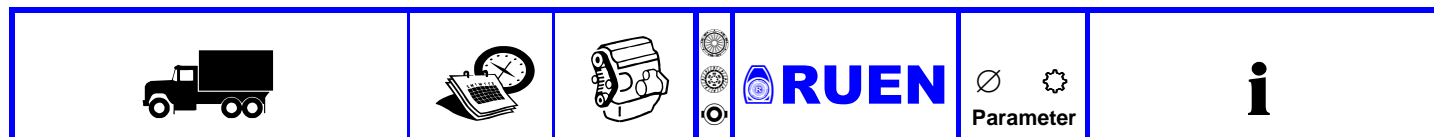

IVECO

EuroCargo I-III 01.91 - 09.15

130 E 24 K tector, 130 E 24 DK tector E4TAC6G2, E4TAC7G2, E4TACBG1, E4TAE6G3, E4TBC7G1, E4TBC9G2, E4TCC6G1, E4TAC6G1, E4TBC4F1	09.00 - 09.15	8360.46.417 8360.46.417 TCA F4AE0681A		38109.30.00	380 10 380GTZ	- Engine code: F4AE0681 - Engine code: 8360.46 E2 - Engine code: 8360.46 - Transmission Number: 2895.9
130 E 28 tector E4UAC8G1, E4UAC9G1, E4UBC2G1, E4UBC6G2, E4UBC8G1, E4UCC7G2, E4UACBG1, E4UBCBG2, E4UCC9G1, E4UBC4G1, E4UBCBG1, Dump Truck	09.00 - 09.15	F4AE0681B F4AE3681D F4AE3681E		8919.40.00	KZISZ - 5	- Engine code: F4AE0681 - Engine code: 8360.46 E2 - Engine code: 8360.46 - Transmission Number: 2895.9
130 E 28 tector E4UAC8G1, E4UAC9G1, E4UBC2G1, E4UBC6G2, E4UBC8G1, E4UCC7G2, EKUAC4G2, EKUAC6GB, EKUAC9G1, EKUBC4GB, EKUBC6GB, Platform/Chassis	09.00 - 09.15					
150 E 24 K tector E6TAC2F1, E6TAC4T1, E6TAC6FA, E6TAC8G1, E6TACBGA, E6TBC5F1, E6TBC7G1, E6TAC4F1, E6TAC5F1, E6TAC6G2, E6TAC9G2	09.00 - 09.15					
150 E 27, 150 E 27 P, 150 E27FP, 150 E 27 R E2FA15A1, E2FB13A1, E2FB13C1, E2FH12Z1, E2FA14A1, E2FA14C1, E2FA15AD, E2FA16A1	01.91 - 09.15					
150 E 28 K tector E6UA87G5, E6UBC5G2, E6UBC9G1, E6UCCBG2, E6UAC7G2, E6UBC2G1, E6UBC7G2, E6UCC8G1, E6UA87G1, E6UBC8G1, E6UBCBG2	09.00 - 09.15					
150 E 28 tector E6UA87G5, E6UBC5G2, E6UBC9G1, E6UCCBG2, EMUAC6G1, EMUAC7GA, EMUACBG1, EMUBC2G1, EMUBC4G1, EMUBC5G1, EMUBC9GA	09.00 - 09.15					
170 E 27, 180 E 27 F0FLC7A1, F0FLC9AD, F0FLC7D1, F0FLC8AD, F0FHC4A1, F0FHC5A1, F0FHC7A1, F0FHC9D1, F0FLC6D1, F0FHC3A1, F0FHC3D1	01.91 - 09.15					
180 E 24 K tector F0TAC5G1, F0TACAFB, F0TACAGB, F0TBC7G1, F0TBC9G1, F0TAC4G1, F0TAC8FA, F0TAC9G2, F0TACBG1, F0TBC4G1, F0TBC5G1	09.00 - 09.15					
180 E 24, 180 E 25 tector F0TAC5G1, F0TACAFB, F0TACAGB, F0TBC7G1, F0TBC9G1, FJTAC4DA, FJTAC4T1, FJTAC5T1, FJTAC5T2, FJTAC7D2	09.00 - 09.15					
180 E 28 K tector F0UAC4G1, F0UAC6G2, F0UAC8GA, F0UBCBGA, F0UAC4GA, F0UACAG1, F0UACAGA, F0UACAGB, F0UBC5G1, F0UBC9G1, F0UAC5G1	09.00 - 09.15					
180 E 28 tector, 180 E 28 P tector F0UAC8GA, F0UBCBGA, FJUAC5G1, FJUAC5GB, FJUAC6GB, FJUAC7G1, FJUAC7G2, FJUAC7T2, FJUAC8T1	09.00 - 09.15					
320 E 27 T E2FB21A1, E2FA22A1, E2FH23A1, E2FA21AD, E2FA22C1, E2FH23D1, E2FL22A1, E2FA21A1, E2FL23A1, E2FL23D1, E2FA22CD	01.91 - 09.15					
320 E 27, 320 E 27 P E2FB21A1, E2FA22A1, E2FH23A1, E2FA21AD, E2FA22C1, E2FH22A1, E2FA21A1, E2FA22CD, E2FB22C1, E2FA22AD	01.92 - 09.15					
320 E 28 T tector E6UA2YG1, E6UB22GA, E6UB2YG2, E6UB22G1, E6UB2YG1, E6UB2YGA	09.00 - 09.15					

Vehicle list



IVECO

EuroCargo I-III 01.91 - 09.15

140 E 24 W tector, 140 E 24 WS tector ENTEC1DA, ENTEC1D1, ENTEC2DA, ENTEC3DA, ENTEC2D1, ENTEC3D1	09.00 - 09.15	F4AE0681B	38109.30.00	380 10 380GTZ	
			8919.40.00	KZISZ - 5	
			4000.90.61 \oplus	400 22 MFZ400X 400GVZ	
			4060.60.00 4052.30.00		
			3953.20.00	395 MF395	- GBox: 6AS800/6AS1000
			8514.40.00	KZI - 4,5	- GBox: 6AS800/6AS1000
150 E 18 K tector 150 E 18 tector, 150 E 18 P tector, 150 E 18 FP tector	09.06 - 09.15 09.06 - 09.15	F4AE3481A	3620.90.52 3607.20.00 3607.30.00 8514.40.00	362 10 MF362 362WGTZ KZI - 4,5	- GBox: ZF 6AS 700 T0
260 E 23 E0DB21BD, E0DB21E1, E0MH22B1, E0DA21BD, E0DA21ED, E0DB21B1, E0ML22B1, E0ML22BD, E0DA21B1, E0DA21E1, E0ML22E1	01.92 - 09.15	8060.45S TCA 8060.45S.6000	3300.90.01 3312.20.00 3315.30.00 5501.40.00	330 10 MFZ330 330GS KZISZ - 3	

Vehicle list

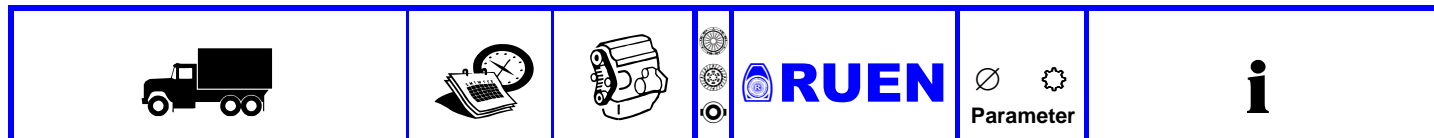

IVECO

EuroCargo IV 09.15 -

65E16, 65E16P F1MBC531, F1MAC2CA, F1MAC431, F1MAC6C1, F1MBC4C1, F1MAC4CA, F1MAC63A, F1MAC6CA, F1MAC23A, F1MAC3CA, F1MAC5C1	09.15 -	F4AFE411A F4AFE411C F4AFE411E F4AFE411F	3620.90.51 3607.20.00 3609.30.00 8514.40.00	362 10 MF362 362 WGTZ KZI - 4,5	- GBox: 6AS 800TO / 6S 800TO
75E16, 75E16P F1MBC531, F1MAC2CA, F1MAC431, F1MAC6C1, F1MBC4C1, F1MAC4CA, F1MAC63A, F1MAC6CA, F1MAC23A, F1MAC3CA, F1MAC5C1	09.15 -	F4AFE611A	3620.90.50 3607.20.00 3608.30.00 8514.40.00	362 10 MF362 362WGTZ KZI - 4,5	- GBox: 6AS 700TO / 6S 700TO
75E19, 75E19P F1NAC2C1, F1NBC231, F1NBC531, F1NAC7C2, F1NBC331, F1NAC231, F1NAC5C1, F1NAC73B, F1NBC631, F1NBC7C2, F1NAC531	09.15 -				
75E21, 75E21P F1RBC231, F1RBC331, F1RBC2C1, F1RBC631, F1RAC63A, F1RAC6CA, F1RBC531, F1RBC6C1, F1RBC731, F1RBC7C2, F1RAC2C1	09.15 -				
80E19, 80E19P, 80EL19, 80EL19P F1NAC2C1, F1NBC231, F1NBC531, F2NAC2C1, F2NAC4C1, F2NBC732, F1NAC7C2, F1NBC331, F2NAC2CA	09.15 -				
80E21, 80E21P, 80E21FP, 80EL21, 80EL21P F2RAC331, F2RAC4C4, F2RBC6C1, F2RBC431, F2RBC732, F2RCC631, F2RAC534, F2RAC5C1, F2RBC2C1	09.15 -				
80EL16, 80EL16P F1MBC531, F1MAC2CA, F1MAC431, F1MAC6C1, F1MBC4C1, F1MAC4CA, F1MAC63A, F1MAC6CA, F1MAC23A, F1MAC3CA, F1MAC5C1	09.15 -				
90E19, 90E19P F2NAC2C1, F2NAC4C1, F2NBC732, F2NAC2CA, F2NBC331, F2NBC531, F2NBC5C1, F2NBC4C1, F2NBC4C4, F2NAC231, F2NAC2T1	09.15 -				
90E21, 9E21P, 80E21FP F2RAC331, F2RAC4C4, F2RBC6C1, F2RBC431, F2RBC732, F2RCC631, F2RAC534, F2RAC5C1, F2RBC2C1, F2RBC5C1	09.15 -				
90E22, 90E22P, 90E22FP F2SAC2F1, F2SBC331, F2SBC532, F2SBC6C1, F2SBC7F1, F2SBC7F2, F2SCC6F2, F2SAC3F1, F2SAC6C1, F2SBC231	09.15 -				
100E19, 100E19P F2NAC2C1, F2NAC4C1, F2NBC732, F2NAC2CA, F2NBC331, F2NBC531, F2NBC5C1, F2NBC4C1, F2NBC4C4, F2NAC231, F2NAC2T1	09.15 -				
100E21, 100E21P, 100E21FP F2RAC331, F2RAC4C4, F2RBC6C1, F2RBC431, F2RBC732, F2RCC631, F2RAC534, F2RAC5C1, F2RBC2C1, F2RBC5C1	09.15 -				
120E19, 120E19P, 120EL19, 120EL19P G1NAC2C1, G1NBC731, G2NBC931, G1NAC531, G1NBC5C1, G2NAC6C1, G2NAC731, G2NAC7C1, G2NAC8C1	09.15 -				
120E21, 120E21P, 120EL21, 120EL21P G1RBC7F2, G2RBC2TA, G2RBC83A, G1RBC431, G1RBC5F2, G1RBC6C1, G1RBC731, G2RAC6F1, G2RACBCB	09.15 -				

Vehicle list









IVECO

EuroCargo IV 09.15 -



140E19, 140E19P G2NBC931, G2NAC6C1, G2NAC731, G2NAC7C1, G2NAC8C1, G2NAC5C1, G2NAC631, G2NBCB31, G2NAC8CA, G2NBC831, G2NBC631	09.15 -	F4AFE411C F4AFE411F F4AFE611A F4AFE611C	3620.90.51 3607.20.00 3609.30.00 8514.40.00	362 10 MF362 362 WGTZ KZI - 4,5	- GBox: 6AS 800TO / 6S 800TO
140E21, 140E21P G2RBC2TA, G2RBC83A, G2RAC6F1, G2RACBCB, G2RBC4C1, G2RBC5C1, G2RBC734, G2RAC53A, G2RAC8C1, G2RBC4F1, G2RBC8C1	09.15 -	F4AFE611E F4GFE601A	3620.90.50 3607.20.00 3608.30.00 8514.40.00	362 10 MF362 362WGTZ KZI - 4,5	- GBox: 6AS 700TO / 6S 700TO
140E22, 140E22FP, 140E22P G2SBC531, G2SBC8F1, G2SCC541, G2SAC731, G2SAC8C1, G2SBC731, G2SCC5F1, G2SAC541, G2SAC9C1, G2SBC5C1	09.15 -				
140E25, 140E25FP, 140E25P G2TAC2F1, G2TAC4F1, G2TBC2F1, G2TBC6C4, G2TBC9C1, G2TBCB32, G2TCC731, G2TCC842, G2TBC631, G2TBC741	09.15 -				
140E28, 140E28FP, 140E28P G2UAC4T1, G2UBC7F1, G2UBCB42, G2UCC842, G2UCC8F2, G2UAC6F1, G2UBC732, G2UBC741, G2UBC7C1, G2UBC8F2	09.15 -				
150E21, 150E21P G3RAC531, G3RBC731, G3RAC73A, G3RBC831, G3RAC4FA, G3RBC73A, G3RBC931, G3RAC83A, G3RAC731	09.15 -				
160E21, 160E21P G3RAC531, G3RBC731, G3RAC73A, G3RBC831, G3RAC4FA, G7PBC5F1, G3RBC73A, G3RBC931, G3RAC83A, G7PAC4T1, G3RAC731	09.15 -				
160E22, 160E22P G3SAC6C1, G3SBC831, G3SBC931, G3SBC741	09.15 -				
160E25, 160E25FP, 160E25P G3TAC74A, G3TAC8F1, G3TBC43A, G3TBC4T1, G3TBC941, G3TBC942, G3TBCBF1, G3TAC731, G3TBC441, G3TBC6F1	09.15 -				
160EL21 CNG, 16EL21P CNG G7PBC5F1, G7PAC4T1	09.15 -				
180E25, 180E25FP, 180E25P	09.15 -				
180E28, 180E28P	09.15 -				
190EL25, 190EL25P	09.15 -				
190EL28, 190EL28P	09.15 -				

Vehicle list



					
---	---	---	--	---	---

IVECO

EuroCargo IV 09.15 -

80E22, 80E22FP F2SAC2F1, F2SBC331, F2SBC532, F2SBC6C1, F2SBC7F1, F2SBC7F2, F2SCC6F2, F2SAC3F1, F2SAC6C1, F2SBC231, F2SBC5C1	09.15 -	F4AFE611A		3953.20.00	395 MF395	- GBox: 6 AS 1000TO, 6S 1000TO, 6AS 800TO / 6S 800TO
		F4AFE611C		8514.40.00	KZI - 4,5	- GBox: 6 AS 1000TO, 6S 1000TO, 6AS 800TO / 6S 800TO
100E22, 100E22P, 100E22FP	09.15 -	F4AFE611E				
F2SAC2F1, F2SBC331, F2SBC532, F2SBC6C1, F2SBC7F1, F2SBC7F2, F2SCC6F2, F2SAC3F1, F2SAC6C1, F2SBC231	09.15 -	F4GFE601A				
110E22, 110E22P, 110E22FP	09.15 -					
G1SAC4F1, G1SBC2F1, G1SAC3C1, G1SBC2T1, G1SBC331, G1SBC3F1, G1SBC5C1, G1SBC5F1, G1SBC631, G1SBC6F1	09.15 -					
120E22, 120E22P, 120E22FP, 120EL22, 120EL22P G1SAC4F1, G2SBC531, G2SBC8F1, G2SCC541, G1SBC2F1, G2SAC731, G2SAC8C1, G2SBC731	09.15 -					
120E25, 120E25FP, 120E25P	09.15 -					
G2TAC2F1, G2TAC4F1, G2TBC2F1, G2TBC6C4, G2TBC9C1, G2TBCB32, G2TCC731, G2TCC842, G2TBC541, G2TBC631	09.15 -					
120E28, 120E28FP, 120E28P	09.15 -					
G2UAC4T1, G2UBC7F1, G2UBCB42, G2UCC842, G2UCC8F2, G2UAC6F1, G2UBC732, G2UBC741, G2UBC7C1, G2UBC8F2	09.15 -					
120EL21 CNG, 12EL21P CN	09.15 -					
GG6PBC3F1, G6PBC5T1, G6PAC3F1, G6PBC5F1	09.15 -					
150E22, 150E22P G3SAC6C1, G3SBC831, G3SBC931, G3SBC741	09.15 -					
150E25, 150E25FP, 150E25P	09.15 -					
G3TAC74A, G3TAC8F1, G3TAC731, G3TAC2C1, G3TCC831, G3TCC842, G3TCC931, G3TAC2F1, G3TACB41, G3TCC7F1	09.15 -					
150E25W G4TEC2C6, G4TEC4C6	09.15 -					
150E28, 150E28FP, 150E28P	09.15 -					
G3UCC942, G3UBC2T1, G3UBC8C1, G3UCC832, G3UCC932, G3UAC2F1, G3UAC4F1, G3UBC7F2, G3UBC841, G3UBC6F1	09.15 -					
150E28W G4UEC1C6	09.15 -					
160E28, 160E28FP, 160E28P	09.15 -					
150E32, 150E32FP, 150E32P	09.15 -	F4AFE611D		8936.40.00	KZISZ - 5	- GBox: 12 AS 1210 TO
G3ZAC4F1, G3ZBC7F1, G3ZBC8F1, G3ZBCB42, G3ZBC5F2, G3ZBC941, G3ZAC2F1, G3ZBC5F1, G3ZBC742, G3ZCC5F1	09.15 -					
160E32, 160E32FP, 160E32P	09.15 -					
180E32, 180E32P	09.15 -					
190EL32, 190EL32P	09.15 -					

EuroFire

























60 .9 A				2820.20.00	280 MF280	
				2832.30.00	280 10 280GTZ	
				6905.40.00	KZIS - 3	

Vehicle list

					
---	---	---	--	---	---









IVECO

EuroFire

65 .12 A			 3169.20.00	310 MF310	
			 3113.30.00	310 10 310GSBL	
			 6905.40.00	KZIS - 3	
75 .14 A-AW 75 .16 A-AW 90 .16 A-AW			 3570.20.00	350 GMF350	
			 3585.30.00	350 10 350GSZ	
			 6905.40.00	KZIS - 3	
75 E 14			 3179.20.00	310 MFZ310	- From chassis no.: 2180117
			 3132.30.00	310 10 310GSB	
			 5501.40.00	KZISZ - 3	- From chassis no.: 2180117
95 E 18	05.91 -		 3100.90.03	310 10 MFZ310 310GSB KZISZ - 3	
120 .19 A-AW 140 .19 A			 3563.20.00	350 GMF350	
			 3583.30.00	350 10 350GSZ	
			 8514.40.00	KZI - 4,5	
120 .23 AW 120 .25 AW,AN 140 .25 A			 3895.20.00	380 G380KR	
			 3816.30.00	380 10 380GSZ	
			 8514.40.00	KZI - 4,5	
130 E 24 135 E 22	05.91 - 05.91 -		 3300.90.01	330 10 MFZ330 330GS KZISZ - 3	
160 .30 AH-AHW			 4253.20.00	420 GFX420KR	
			 4268.30.00	420 10 420GSZ	
			 8514.40.00	KZI - 4,5	
75 E 14	05.91 -		 2858.30.00	280 10 280GTZ	- To chassis no.: 2180116
			 5501.40.00	KZISZ - 3	- To chassis no.: 2180116
150 E 27	12.91 -		 38109.30.00	380 10 380GTZ	
			 8919.40.00	KZISZ - 5	

EuroStar

01.93 - 02.02

LD 190 E 39 P, LD 190 E 39 FP L1JC18F2, L1JCL8F2, L1JB15H2, L1JB17N2, L1JC17F2, L1JCL7N2, L1JC18H2, L1JCL7F2, L1JCL8C2, L1JCL9N2	11.99 - 02.02	F3AE0681E	 4300.90.04	430 10 MFZ430 430WGTZ KZISZ - 5	- Engine code: F3AE0681 - Use release fork with cam
			 4301.20.00		
			 4326.30.00		
			 8919.40.00		
			 4300.90.176	430 10 MFZ430 430WGTZ KZISZ - 5	- Engine code: F3AE0681 - Use release fork with rollers
			 4301.20.00		
			 4326.30.00		
			 8939.40.00		

Vehicle list

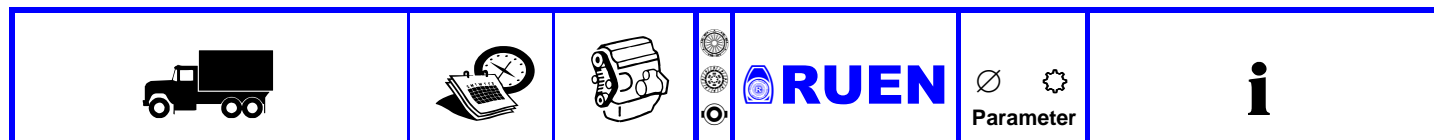

IVECO

EuroStar		01.93 - 02.02			
LD 190 E 40 LD 260 E 40 LD 440 E 40 T LD 440 E 40 TX/P	09.00 - 02.02 09.00 - 02.02 09.00 - 02.02 01.01 - 02.02	F3AE0681B	4300.90.04 4301.20.00 4326.30.00 8919.40.00 4300.90.176 4301.20.00 4326.30.00 8939.40.00	430 10 MFZ430 430WGTZ KZISZ - 5 430 10 MFZ430 430WGTZ KZISZ - 5	- GBox: ZF - Use release fork with cam - GBox: ZF - Use release fork with rollers
LD 190 E 42, LD 190 E 42 P L1CB13D1, L1CB14D1, L1CB15D1, L1CL13D1, L1CL14D1, L1CB15C1, L1CA12C1, L1CA12D1, L1CL14C1, L1CH12D1	01.93 - 02.02	8210.42L(TCA) 8210.42L. 8210.42L.400 8210.42M. TCA	4300.90.02 4301.20.00 4327.30.00 8919.40.00	430 10 MFZ430 430GTZ KZISZ - 5	- Engine code: 8210 - GBox: Fuller
LD 190 E 47 L1DB13C1, L1DB14C1, L1DC14K1, L1DA12C1, L1DC15K1, L1DB14D1, L1DB15D1, L1DA15C1, L1DB13D1, L1DB14K1, L1DA12D1	01.93 - 02.02		4300.90.04 4301.20.00 4326.30.00 8919.40.00	430 10 MFZ430 430WGTZ KZISZ - 5	- Engine code: 8210 - GBox: ZF - Use release fork with cam
LD 240 E 42 FS, LD 240 E 42 PS L3CE13D1, L3CE15C1, L3CF13C1, L3CF14D1, L3CM13C1, L3CP15C1, L3CR14D1, L7CB16D1, L7CL15D1	01.93 - 02.02		4300.90.176 4301.20.00 4326.30.00 8939.40.00	430 10 MFZ430 430WGTZ KZISZ - 5	- Engine code: 8210 - GBox: ZF - Use release fork with rollers
LD 240 E 47 PS L3DB15D1, L3DC13D1, L3DC15K1, L3DE13D1, L3DE15D1, L3DE14D1, L3DF13D1, L3DC14K1, L3DC15D1, L3DF14C1, L3DF14D1	01.93 - 02.02				
LD 260 E 42 P L4CL14D1, L4CL15D1	01.93 - 02.02				
LD 260 E 47 L4DB15D1, L4DC15D1, L4DC15C1, L4DA13D1, L4DA15D1, L4DA16D1	01.93 - 02.02				
LD 400 E 42 TX/P, LD 440 E 42 TX/P L1CA23D1, L0CA22D1, L1CB22D1, L1CC22C1, L1CL22D1, L1CM22C1, L1CM23C1, L0CB22D1, L1CB23C1	01.93 - 02.02				
LD 440 E 42 T/P L1CA23D1, L1CB22D1, L1CC22C1, L1CL22D1, L1CM22C1, L1CM23C1, L1CB23C1, L1CC23D1, L1CM22D1, L1CH22C1, L1CH23C1	01.93 - 02.02				
LD 440 E 42 TZ L1CA23D1, L1CB22D1, L1CC22C1, L1CL22D1, L1CM22C1, L1CM23C1, L1CB23C1, L1CC23D1, L1CM22D1, L1CH22C1, L1CH23C1	01.93 - 02.02				
LD 440 E 47 T/P L1DB23D1, L1DA22C1, L1DB22K1, L1DC22D1, L1DC23D1, L1DB21K1, L1DB22C1, L1DC23C1, L1DB22D1, L1DB23C1, L1DB23K1	01.93 - 02.02				
LD 440 E 47 TZ L1DB23D1, L1DA22C1, L1DB22K1, L1DC22D1, L1DC23D1, L1DB21K1, L1DB22C1, L1DC23C1, L1DB22D1, L1DB23C1, L1DB23K1	01.93 - 02.02				
LD 190 E 43, LD 190 E 43 P, LD 190 E 43 FP L1JB15F2, L1JC18F2, L1KB18D2, L1KB19C2, L1KC17C2, L1JB17FD, L1JC17F2, L1JB18F2	11.99 - 02.02	F3AE0681D	4300.90.04 4301.20.00 4326.30.00 8919.40.00 4300.90.176 4301.20.00 4326.30.00 8939.40.00	430 10 MFZ430 430WGTZ KZISZ - 5 430 10 MFZ430 430WGTZ KZISZ - 5	- Engine code: F3AE0681 - Use release fork with cam - Engine code: F3AE0681 - Use release fork with rollers

Vehicle list

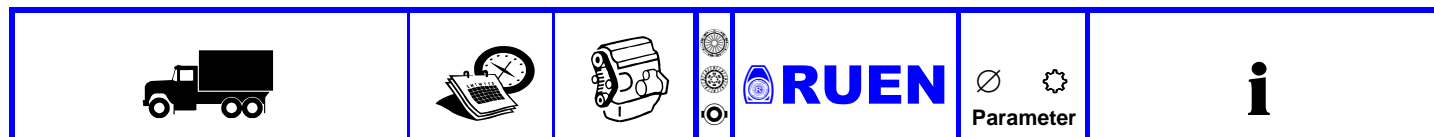







IVECO

EuroStar 01.93 - 02.02











LD 190 E 52 L1EB14D1, L1EB14C1, L1EA12C1, L1EA14D1, L1EB13C1, L1EB15D1, L1EA12D1	01.93 - 02.02	8280.42S. TCA		4300.90.02 4301.20.00 4327.30.00 8919.40.00	430 10 MFZ430 430GTZ KZISZ - 5	- GBox: Fuller
LD 240 E 52 PS L3EB15D1, L3EE14C1, L3EE14D1, L3EB16D1, L3EE16C1, L3EF13D1, L3EE13C1, L3EE15C1, L3EE15D1, L3EB13C1, L3EE16D1	01.93 - 02.02			4300.90.04 4301.20.00 4326.30.00 8919.40.00	430 10 MFZ430 430WGTZ KZISZ - 5	- GBox: ZF - Use release fork with cam
LD 260 E 52 L4EA15D1, L4EC15D1, L4EB15D1	01.93 - 02.02			4300.90.176 4301.20.00 4326.30.00 8939.40.00	430 10 MFZ430 430WGTZ KZISZ - 5	- GBox: ZF - Use release fork with rollers
LD 440 E 52 T L1EA22D1, L1EA23C1, L1EA23D1, L1EC22D1, L1EB23C1, L1EB23D1, L1EC23C1, L4EA21D1, L4EB21D1, L1EC22C1, L1EC23D1	01.93 - 02.02			4300.90.176 4301.20.00 4326.30.00 8939.40.00	430 10 MFZ430 430WGTZ KZISZ - 5	- GBox: ZF - Use release fork with rollers
LD 440 E 52 TZ L1EA22D1, L1EA23C1, L1EA23D1, L1EC22D1, L1EB23C1, L1EB23D1, L1EC23C1, L4EA21D1, L4EB21D1, L1EC22C1, L1EC23D1	01.93 - 02.02			4300.90.176 4301.20.00 4326.30.00 8939.40.00	430 10 MFZ430 430WGTZ KZISZ - 5	- GBox: ZF - Use release fork with rollers
LD 260 E 39 P, LD 260 E 39 FP L3JB16E2, L3JB17CD, L3JC14F2, L3JCL7CD, L3JE15H2, L3JE17N2, L3JE19N2, L3JF16F2, L3JF17F2, L3JB15N2	11.99 - 02.02	F3AE0681D F3AE0681E F3BE0681E		4300.90.04 4301.20.00 4326.30.00 8919.40.00	430 10 MFZ430 430WGTZ KZISZ - 5	- Engine code: F3AE0681 - Use release fork with cam
LD 260 E 43 Y/PS, LD 260 E 43 FP L3JF16F2, L3JF17F2, L3KC17C2, L3KCL7D2, L3KE16D2, L3JF14F2, L3JFL7F2, L3KB15C2, L3KB16A2	01.93 - 02.02			4300.90.176 4301.20.00 4326.30.00 8939.40.00	430 10 MFZ430 430WGTZ KZISZ - 5	- Engine code: F3AE0681 - Use release fork with rollers
LD 440 E 39 T, LD 440 E 39 T/P L1JB21C2, L1JBH3FD, L1JB21F2, L1JBH1F2, L1JB23C2, L1JB23F2, L1JBH3F2, L1JCT1C2, L1JB23CD	11.99 - 02.02					
LD 440 E 43 T/P L1JBH3FD, L1JB21F2, L1JBH1F2, L1KB21C2, L1KB23C2, L1JB23F2, L1JBH3F2, L1KBH3CD, L1JB21FD, L1JCT1F2, L1KBH1C2	01.93 - 02.02					
LD 440 E 43 TX/P L1KB21C2, L1KB23C2, L1KB23LD, L2JB21F2, L1KB21L2, L1KB23L2, L2KB21C2, L2KB21LD, L1KB21DD, L1KB21J2, L1KCT1LD	11.99 - 02.02					
LD 440 E 48 T/P L1PB21L2, L1PB21W2, L1PB2142, L1PB21G2, L1PB2112, L1PBH3G2, L1PB23G2, L1PB23J2, L1PB23L2, L1PB21J2, L1PB23GD	01.01 - 02.02					
240 E 52	01.92 -			4327.30.00	430 10 430GTZ	- Engine code: 8210 - GBox: Fuller
				4326.30.00	430 10 430WGTZ	- Engine code: 8210 - GBox: ZF
				8919.40.00	KZISZ - 5	- Engine code: 8210 - GBox: ZF - GBox: Fuller - Use release fork with cam

Vehicle list













					
---	---	---	--	---	---

IVECO







EuroStar 01.93 - 02.02

LD 190 E 38 P L1BB14D1, L1BL14D1, L1BB15D1, L1BL15D1, L1BB14C1	01.93 - 02.02	8460.41L TCA		4006.30.00	400 10 400GVZ	- Engine code: 8460 - GBox: Fuller
LD 240 E 38 L3BB14D1, L3BB15D1, L3BC14D1, L3BL14D1, L3BM14K1, L3BP14D1, L3BE16D1, L3BP15D1, L3BR14D1, L3BB16D1, L3BC14C1	01.93 - 02.02	8460.41L.5020		8919.40.00	KZISZ - 5	- Engine code: 8460 - GBox: Fuller
LD 260 E 38 P	01.93 - 02.02	8460.41N		4007.30.00	400 10 400WGTZ	- Engine code: 8460 - GBox: ZF
LD 400 E 38 TX/P, LD 440 E 38 TX/P	01.93 - 02.02					
L0BL23CD, L0BL23KD, L1BL23C1, L2BL21C1, L2BL21CD, L1BB23D1, L2BB21D1, L1BL21C1, L1BG21D1	01.93 - 02.02					
LD 440 E 38 T L1BL23C1, L1BB23D1, L1BH23D1, L1BB22D1, L1BL23K1, L1BL22D1, L1BL23D1, L1BA23D1, L1BB23C1	01.93 - 02.02					
LD 440 E 38 TZ L1BL23C1, L1BB23D1, L1BH23D1, L1BB22D1, L1BL23K1, L1BL22D1, L1BL23D1, L1BA23D1, L1BB23C1	01.93 - 02.02					
LD 260 E 48 Y/PS	01.93 - 02.02	F3BE0681E		4300.90.04	430 10 MFZ430	- Engine code: F3AE0681 - Use release fork with cam
				4301.20.00	430WGTZ	
				4326.30.00	KZISZ - 5	
				8919.40.00		
				4300.90.176	430 10 MFZ430	- Engine code: F3AE0681 - Use release fork with rollers
				4301.20.00	430WGTZ	
				4326.30.00	KZISZ - 5	
				8939.40.00		























EuroTech MH 01.98 -

190 E 24 K	09.98 -	F2BE0681B		4005.30.00	400 10 400GVZ	- GBox: AS Tronic
190 E 27 K	09.98 -	F2BE0681C		8919.40.00	KZISZ - 5	- GBox: AS Tronic
190 E 31 K	09.98 -	F2BE0681D				
260 E 27 Y/P, 260 E 27 Y/PS, 260 E 27 RY/PS, 260 E 27 RY/PT M3NB14A2, M3NB16AC, M3NB18A2, M3NE14A1, M3NE15A1, M3NE16AC, M3NE17A1	11.99 -	F2BE0681F				
190 E 24, 190 E 24 /P M1NA18A2, M1NA19A2, M1NB15D1, M1NB17A1, M1NB17AC, M1NA13A1, M1NB14AC, M1NB15A2, M1NB16A1, M1NB16D1	09.98 -	F2BE0681D		38109.30.00	380 10 380GTZ	- Engine code: F2BE0681 - Transmission Number: 2895.9
				8919.40.00	KZISZ - 5	- Engine code: F2BE0681 - Transmission Number: 2895.9
				4005.30.00	400 10 400GVZ	- Engine code: F2BE0681 - Transmission Number: 2895.9
190 E 27, 190 E 27 /P M1NA18A2, M1NA19A2, M1NB15D1, M1NB17A1, M1NB17AC, M1PA14B1, M1PA16B2, M1PA17B1, M1PA17B2, M1PA18B1	09.98 -	F2BE0681C F2BE0681F		38109.30.00	380 10 380GTZ	
				8919.40.00	KZISZ - 5	
190 E 31, 190 E 31 /P M1PA14B1, M1PA16B2, M1PA17B1, M1PA17B2, M1PA18B1, M1PB17BD, M1PB17C2, M1PB1MCC, M1PA16B1, M1PB19CC	09.98 -	F2BE0681B		4007.30.00	400 10 400WGTZ	- Engine code: F2BE0681 - GBox: AS-tronic
260 E 31 Y/P, 260 E 31 Y/PS, 260 E 31 Y/PT M3PB18B2, M3PB19C2, M3PE16B1, M3PE16C1, M3PE16C2, M3PE18C2, M7PB16B1, M7PB17B2	11.99 -			8919.40.00	KZISZ - 5	- Engine code: F2BE0681 - GBox: AS-tronic - GBox: 16S 109
400 E 31 TP, 440 E 31 T, 440 E 31 TP	09.98 -			4005.30.00	400 10 400GVZ	- Engine code: F2BE0681 - GBox: 16S 109
M1PA23B1, M1PB21C1, M1PB23BD, M1PA21B2, M1PA23B2, M1PB21C2, M1PB23C2, M1PB21BD, M1PB21CD						

Vehicle list

					
---	---	---	--	---	---

IVECO

EuroTech MH		01.98 -				
190 E 35, 190 E 35 /P, 190 E 35 /FP M1RA13B1, M1RA16B2, M1RB16CD, M1RB17B1, M1RB18B1, M1RB18CD, M1RB19B1, M1RB19B2, M1RB1MB1 260 E 35 Y/P, 260 E 35 Y/PT, 260 E 35 Y/TN M3RB14B1, M3RB14B2, M3RB15C1, M3RB16B2, M3RB19BC, M3RB19CC, M3RE18BD, M3RE19C1 400 E 35 TP, 440 E 35 T, 440 E 35 T/P, 440 E 35 T/FP M1RA21BC, M1RCT3C2, M2RB21CZ, M1RA23B1, M1RB23C2, M1RD21B2, M1RA21B2	09.98 -	F2BE0681A	 4007.30.00	400 10 400WGTZ	- Engine code: F2BE0681 - GBox: 16S 151	
	11.99 -		 8919.40.00	KZISZ - 5	- Engine code: F2BE0681 - GBox: 16S 151 - GBox: 12AS 1800 DD	
260 E 24 Y/P, 260 E 24 Y/PS, 260 E 24 Y/PT M3NB14A2, M3NB16AC, M3NB18A2, M3NE14A1, M3NE15A1, M3NE16AC, M3NE17A1, M3NE17A2	09.98 -	F2BE0681D	 4005.30.00	400 10 400GVZ	- Engine code: F2BE0681 - Transmission Number: 2895.9	
	11.99 -		 8919.40.00	KZISZ - 5	- Engine code: F2BE0681 - Transmission Number: 2895.9	
EuroTech MP		01.92 -				
180 E 42 M0CA14B1, M0CB13D1, M0CB15B1, M0CA14C1, M0CA15D1, M0CB13C1, M0CA12B1, M0CB13A1, M0CB14B1, M0CA14D1, M0CB13B1, M0CB15D1 190 E 42, 190 E 42 /P M1CA15A1, M1CB14A1, M1CH14C1, M1CL13B1, M1CA12B1, M1CA13A1, M1CA13C1, M1CA13D1, M1CA14C1, M1CB13D1 240 E 42 M3CC13D1, M3CC14C1, M3CC15B1, M3CL15A1, M3CP13B1, M3CP16C1, M3CB13A1, M3CB14B1, M3CC13A1, M3CC15C1, M3CE13A1, M3CE14B1 260 E 42 M4CA16B1, M4CL13B1, M4CA11A1, M4CA15B1, M4CB13D1, M4CA15D1, M4CB14D1, M4CB15C1, M4CH15H1, M4CL15B1, M4CA16C1, M4CB13C1 400 E 42 T, 440 E 42 T, 440 E 42 T/P M0CA22C1, M0CA22D1, M1CA22DD, M1CB23C1, M1CB23D1, M1CC23D1, M1CH22A1, M1CL23H1, M4CA21C1 440 E 42 TZ M4CA21C1, M4CB21C1, M4CA21DD, M4CB21B1, M4CH21B1, M4CH21C1, M4CL21C1, M7CA22CD, M4CL21B1, M7CA22DD, M4CA21A1	01.92 - 12.93	8210.42L(TCA) 8210.42L.400	 4300.90.02	430 10 MFZ430 430GTZ KZISZ - 5	- GBox: Fuller	
	01.93 -		 4301.20.00  4327.30.00  8919.40.00	 4300.90.04	430 10 MFZ430 430WGTZ KZISZ - 5	- GBox: ZF - Use release fork with cam
01.92 -	 4300.90.176	 4301.20.00  4326.30.00  8939.40.00	430 10 MFZ430 430WGTZ KZISZ - 5	- Engine code: 8210 - GBox: ZF - Use release fork with rollers		
01.94 -						
01.92 -						
01.93 -						
190 E 39, 190 E 39 /P, 190 E39 /FP M1JA15F2, M1JA17F1, M1JA18C1, M1JB15E1, M1JB17E1, M1JB19C2, M1JB19F2, M1JB19N2, M1JC16C1 190 E 43, 190 E 43 /P M1KA15C2, M1KA15F2, M1KA18F1, M1KA19F1, M1KB15D2, M1KB17D2, M1KC8D2, M1KA15C1, M1KA17F1, M1KB18A1	11.99 -	F3AE0681D F3AE0681E	 4300.90.04	430 10 MFZ430 430WGTZ KZISZ - 5	- Engine code: F3AE0681 - Use release fork with cam	
	01.01 -		 4300.90.176	 4301.20.00  4326.30.00  8939.40.00	430 10 MFZ430 430WGTZ KZISZ - 5	- Engine code: F3AE0681 - Use release fork with rollers
260 E 39 Y, 260 E 39 Y/P, 260 E 39 Y/FP, 260 E 39 Y/FS M3JB16D1, M3JB17C2, M3JC15C2, M3JC15F2, M3JC16F2, M3JC17C2, M3JE15D2 260 E 43 Y, 260 E 43 Y/P M3KB15D1, M3KB16D1, M3KC15D2, M3KE16D2, M3KF15D1, M7KB16D2, M3JE16C2, M3JE16F2, M3KB17D2, M3KE17C2	11.99 -	F3AE0681D F3AE0681E	 4300.90.04	430 10 MFZ430 430WGTZ KZISZ - 5	- Engine code: F3AE0681 - Use release fork with cam	
	11.99 -		 4300.90.176	 4301.20.00  4326.30.00  8939.40.00	430 10 MFZ430 430WGTZ KZISZ - 5	- Engine code: F3AE0681 - Use release fork with rollers

Vehicle list

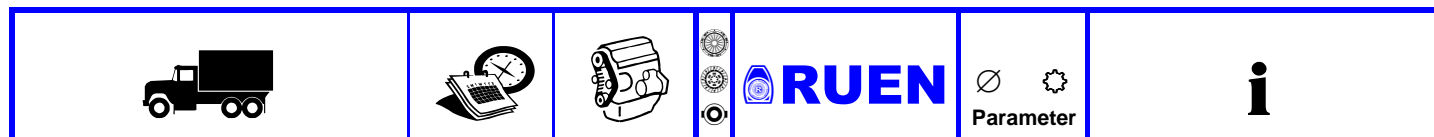

IVECO

EuroTech MP 01.92 -

440 E 39 T, 440 E 39 T/P, 440 E 39 T/FP-CT M1JA23F1, M1JB21C1, M1JB21CD, M1JB21FD, M1JB21N2, M1JB23G2, M1JB23PD, M1JBH3CD	11.99 -	F3AE0681D F3AE0681E		4300.90.04 4301.20.00 4326.30.00 8919.40.00	430 10 MFZ430 430WGTZ KZISZ - 5	- Engine code: F3AE0681 - Use release fork with cam
440 E 39 TX/P M1JB21C1, M1JB21N2, M1JB23G2, M1JB23PD, M1JCT3FD, M1JD23D2, M2JB21G2, M1JB21C2, M1JB21F1, M1JB21H2, M1JB23CD	11.99 -			4300.90.176 4301.20.00 4326.30.00 8939.40.00	430 10 MFZ430 430WGTZ KZISZ - 5	- Engine code: F3AE0681 - Use release fork with rollers
440 E 43 T, 440 E 43 T/P M1JA23F1, M1JAH3F1, M1JB21FD, M1KB21J2, M1KBH1A2, M1KCT1L2, M1KD21D1, M1KE2121, M2KB21CD, M1JA21F1	11.99 -					
180 E 34 M0AA13C1, M0AA15A1, M0AA16D1, M0AB15C1, M0AL14AD, M0AA12A1, M0AA15AD, M0AA15D1, M0AB15A1, M0AB15B1, M0AA15DD, M0AA13A1	01.92 - 12.93	8460.41K. TCA 8460.41K.406 8460.41L. TCA 8460.41L.5020		4007.30.00	400 10 400WGTZ	- Engine code: 8460 - GBox: ZF
180 E 38 M0BA13A1, M0BA13CD, M0BA13D1, M0BA14B1, M0BA14D1, M0BA15AD, M0BA15BD, M0BA16B1, M0BB13B1, M0BA12D1, M0BB14D1, M0BA12A1	01.92 - 12.93	8460.41N		8919.40.00	KZISZ - 5	- Engine code: 8460 - GBox: ZF
180 E 38 M0BA13A1, M0BA13CD, M0BA13D1, M0BA14B1, M0BA14D1, M0BA15AD, M0BA15BD, M0BA16B1, M0BB13B1, M0BA12D1, M0BB14D1, M0BA12A1	01.92 - 12.93	8460.41N		4006.30.00	400 10 400GVZ	- Engine code: 8460 - GBox: ZF - GBox: Fuller
190 E 34 M1AA13D1, M1AA14D1, M1AA15D1, M1AB13B1, M1AB14D1, M1AB16B1, M1AH14B1, M1AH14C1, M1AL14A1, M1AL14D1, M1AA12A1, M1AB15D1	01.93 -					
190 E 38 M1BA12B1, M1BA13B1, M1BB13B1, M1BH14D1, M1BH16B1, M1BN17DD, M1BA12C1, M1BA15D1, M1BB14D1, M1BH12D1, M1BA12A1, M1BA12D1	01.93 -					
240 E 34 M7AA15B1, M3AM13B1, M7AH15A1, M3AM14B1, M7AA15A1, M7AA15C1, M7AA15D1, M7AA16C1, M7AH14D1, M3AM15D1, M7AA14D1, M7AH13A1	09.95 - 12.96					
240 E 38 M3BB14A1, M3BB16C1, M3BE14B1, M3BF13B1, M3BL15B1, M3BL15D1, M3BL16D1, M3BP13A1, M3BP15D1, M3BR14B1, M7BA11D1, M7BA13C1	01.92 -					
260 E 38 P M4BB13C1, M4BB15D1, M4BL15B1, M4BB14B1, M4BB14C1, M4BB13A1, M4BB15B1, M4BC15D1	01.94 -					
400 E 34 T, 440 E 34 T M0AA22CD, M0AB22B1, M0AB23C1, M0AL23CD, M1AA22DD, M1AA23B1, M1AA23D1, M1AB22A1, M1AB22D1, M1AH22D1	01.92 -					
400 E 38 T, 440 E 38 T, 440 E 38 T/P M1BA23C1, M1BB22A1, M1BB22C1, M1BB23C1, M1BH22B1, M1BL21K1, M1BL23C1, M0BA23CD, M0BB22CD	01.92 -					
400 E 38 TXP M2BB21AD, M2BB21C1, M2BB21D1, M2BB21B1, M2BB21BD, M2BL21B1, M2BB21A1, M2BB21DD, M2BL21DD, M2BB21CD, M2BL21BD	11.93 - 12.96					
440 E 38 TZ M4BB21D1, M4BA21D1, M4BB21B1, M4BL21D1, M4BC21D1	01.93 -					
240 E 30 PS M3FE13B1, M3FE13J1, M3FP13B1	01.97 -	8460.41C. TCA		4007.30.00	400 10 400WGTZ	- Engine code: 8460
				8919.40.00	KZISZ - 5	- Engine code: 8460

Vehicle list



IVECO







EuroTech MT 01.92 - 08.98

180 E 24 F1CAC8A1, F1CAC9C1, F1CBC8C1, F1CAC8C1, F1CBC6A1, F1CBC9A1, F1CAC6A1, F1CBC9C1, F1CAC3A1, F1CAC3C1, F1CAC4A1, F1CAC6C1	01.92 - 12.96	8360.46.417 TCA 8360.46R.416 TCA		38109.30.00	380 10 380GTZ	- Engine code: 8360
					8919.40.00	KZISZ - 5
180 E 24 K F1CAD2A1, F1CAD1A1	01.93 - 12.96					
180 E 27 F1DA13A1, F1DB16A1, F1DBC6A1, F1DBC9C1, F1DA18C1, F1DAC2C1, F1DAC8C1, F1DB13A1, F1DBC6CD, F1DBC9A1, F1DA11A1, F1DA16C1	01.92 - 12.96					
180 E 27 K F1DAD1A1, F1DA31A1, F1DA32A1	01.92 - 12.96					
190 E 24 F3CBC8A1, F3CBC9A1, F3CBC9C1, F3CAC1A1, F3CAC6A1, F3CAC9A1, F3CBC8C1, F3CBC4A1, F3CAC3A1, F3CAC3C1, F3CAC4A1, F3CAC8A1	01.97 - 08.98					
190 E 24 K F3CAD1A1, F3CAD2A1	01.97 - 08.98					
190 E 27 F3DA19C1, F3DBC9C1, F3DA14C1, F3DAC8C1, F3DBC3A1, F3DBC9A1, F3DAC4A1, F3DAC9A1, F3DBC6A1, F3DBC8A1, F3DA11A1, F3DA14A1	01.97 - 08.98					
190 E 27 K F3DA31A1, F3DAD1A1, F3DAD2A1, F3DA32A1	01.97 - 08.98					
180 E 30 R F2GB14C1, F2GA12B1, F2GA19H1, F2GB13C1, F2GB13HD, F2GB16B1, F2GC14G1, F2GA11C1, F2GA13B1, F2GA14C1, F2GA18G1	01.92 - 12.96	8460.41C.320		4005.30.00	400 10 400GVZ	- Engine code: 8460 - GBox: ZF
					8919.40.00	KZISZ - 5
190 E 30 F3GAC2H1, F3GAC3G1, F3GAC4G1, F3GBC4B1, F3GA14B1, F3GAC2G1, F3GAC3B1, F3GAC8C1, F3GBC6B1, F3GBC8B1, F3GBC9G1, F3GA13B1	01.97 - 08.98			4006.30.00	400 10 400GVZ	- Engine code: 8460 - GBox: Fuller
190 E 30 K F3GAD2C1, F3GAD1C1, F3GAD3C1, F3GAD3B1, F3GAD1B1, F3GAD2B1	01.97 - 08.98					
400 E 30 T F2GA21B1, F2GA21CD, F2GA22GD, F2GA23BD, F2GA23G1, F2GB22GD, F2GB22HD, F2GB23B1, F2GA21BD, F2GA23B1, F2GB21B1	01.92 - 08.98					
180 E 34 R F2HA12A1, F2HA16D1, F2HA12D1, F2HA14A1, F2HA19D1, F2HB18D1, F2HB18E1, F2HA11A1, F2HB16A1, F2HB19D1, F2HA11B1	01.92 - 12.93	8460.41K.406		4007.30.00	400 10 400WGTZ	- Engine code: 8460 - GBox: ZF
					8919.40.00	KZISZ - 5
400 E 34 T F2HA22AD, F2HA22D1, F2HB23D1, F2HA22A1, F2HB22A1, F2HB22E1, F2HB23BD, F2HA22DD, F2HA23D1, F2HA22ED, F2HA23E1	01.92 - 08.98			4006.30.00	400 10 400GVZ	- Engine code: 8460 - GBox: Fuller

EuroTrakker 01.93 - 11.04









MP 190 E 37 H K0EB12D8, K0EA12E1, K0EC12D1, K0EA12D1, K0EA13E1, K0EB12E1, K0EA13E8, K0ED12D1, K0EB12D1, K0EA12A1, K0EB13D1	01.93 - 11.04	8210.42K.		4300.90.02	430 10 MFZ430 430GTZ KZISZ - 5	
						4301.20.00
MP 190 E 37 W K0EB12D8, K0EA12E1, K0EC12D1, K0EA12D1, K0EA13E1, K0EB12E1, K0EA13E8, K0ED12D1, K0EB12D1, K0EA12A1, K0EB13D1	01.93 - 11.04					

Vehicle list

					
---	---	---	--	---	---

IVECO

EuroTrakker 01.93 - 11.04

<p>MP 190 E 38 W Cursor K0LA12C2, K0LA13C2, K0LB13C3, K0LA13C4, K0LB14C3, K0LB13H3, K0LB12C3, K0LB14H3, K0LB13H5, K0LB12C5, Platform/Chassis</p>	<p>01.01 - 11.04</p>	<p>F3BE0681G</p>	<p> 4300.90.04  4301.20.00  4326.30.00  8919.40.00</p>	<p>430 10 MFZ430 430WGTZ KZISZ - 5</p>	<p>- Engine code: F3AE0681 - Use release fork with cam</p>
<p>MP 190 E 38 W Cursor K0LA12C2, K0LA13C2, K0LB13C3, K0LA13C4, K0LB14C3, K0LB12C3, K0LB14H3, K0LA14C2, K0LB12H3, K0LB12H5, Dump Truck</p>	<p>01.01 - 11.04</p>		<p> 4300.90.176  4301.20.00  4326.30.00  8939.40.00</p>	<p>430 10 MFZ430 430WGTZ KZISZ - 5</p>	<p>- Engine code: F3AE0681 - Use release fork with rollers</p>

Vehicle list



IVECO

EuroTrakker 01.93 - 11.04

MP 190 E 42 H K0FA12D1, K0FB12K1, K0FB12D1	01.93 - 11.04	8210.42K(TCA)		4300.90.02	430 10	- GBox: Fuller
MP 190 E 42 W K0FD13D1, K0FD13F1, K0FA12D1, K0FD12D1, K0FD13A1, K0FD14J1, K0FB12K1, K0FD12C1, K0FD12J1, K0FD13J1, K0FD14D1	01.93 - 11.04	8210.42K. 8210.42L(TCA) 8210.42L.		4301.20.00 4327.30.00 8919.40.00	MFZ430 430GTZ KZISZ - 5	
MP 260 E 37 H K1EA15B1, K1EA17C1, K1EC12C1, K1ED13B1, K1EA12B1, K1EA15C8, K1EA16B1, K1EA17B1, K1EA17D1, K1EB13C1, K1EA12C1	01.93 - 11.04			4300.90.04	430 10	- Engine code: 8210 - GBox: ZF - Use release fork with cam
MP 260 E 37 W K1EA17C1, K1EC12C1, K1ED13B1, K1EA15B1, K1EA16B1, K1EA12B1, K1EA15C8, K1EA17B1, K1EA17D1, K1EB13C1, K1EB13B1	01.93 - 11.04			4301.20.00 4326.30.00 8919.40.00	MFZ430 430WGTZ KZISZ - 5	
MP 260 E 42 H K1FB13B1, K1FC12C1, K1FC16F1, K1FA12B1, K1FB14A1, K1FD13B1	01.93 - 11.04			4300.90.176	430 10	- Engine code: 8210 - GBox: ZF - Use release fork with rollers
MP 260 E 42 W K1FD14B1, K1FB13B1, K1FD14A1, K1FC12C1, K1FC16F1, K1FD14E1, K1FA12B1, K1FB14A1, K1FD13B1, K1FD13D1, K1FD13A1	01.93 - 11.04					
MP 380 E 37 W K3EA12A5, K3EA13DE, K3EA15F5, K3EB13D1, K3EB14E1, K3EC13A1, K3EC13D1, K3EC15A1, K3EA13A1, K3EA14D5, K3EA14E1	01.93 - 11.04					
MP 380 E 37 H K3EA12A5, K3EA13DE, K3EA15F5, K3EB13D1, K3EB14E1, K3EC13A1, K3EC13D1, K3EC15A1, K3EA13A1, K3EA14D5, K3EA14E1	01.93 - 11.04					
MP 410 E 37 H K5EC13B1, K5EA11B1, K5EC11B1, K5EA11A1	01.93 - 11.04					
MP 440 E 37 HT K1EA21E1, K1EC22BD, K1EC22G1, K1EA22B1, K1EA22D1, K1EC21A1, K1EC21E1, K1EC21ED, K1EC21F1, K1EC25H1, K1EC21C1	01.93 - 11.04					
MP 440 E 42 HT K1FC25H1, K1FC26G1, K1FC26H1, K1FC21B1, K1FC21F1, K1FC22B1, K1FC23H1, K1FC24H1, K1FC21C1, K1FC22F1, K1FC23G1	01.93 - 11.04					
MP 720 E 37 HT K3EA22D5, K3EB24D5, K3EC22A1, K3EC23D1, K3EA22A1, K3EA22D1, K3EA23A5, K3EC22D1, K3EC22F1, K3EC22J1, K3EC23A1	01.93 - 11.04					
MP 720 E 37 WT K3EA22D5, K3EB24D5, K3EA22A1, K3EA22D1, K3EA23A5, K3EC22D1, K3EA23FE, K3ED23J1, K3EA22FE, K3EA23F5, K3EA23J5	01.93 - 11.04					
MP 720 E 42 HT K3FA22A1, K3FA22J1, K3FC23J1, K3FA22K1, K3FA23F5, K3FA23FE, K3FB23J5, K3FC22J1, K3FC23D1, K3FA22F1, K3FC22A1	01.93 - 11.04					
MP 720 E 42 WT K3FA22A1, K3FA22J1, K3FB23A5, K3FB23F5, K3FB23G5, K3FB24D5, K3FA22K1, K3FA23F5, K3FA23FE, K3FB23J5, K3FB24A5	01.93 - 11.04					

Vehicle list



IVECO

EuroTrakker 01.93 - 11.04





























MP 190 E 44 W Cursor K0MB12C5, K0MB12H5, K0MB14C3, K0MA12C2, K0MA13C2, K0MB12C3, K0MB12D3, K0MB12H3, K0MB13H3, K0MB13H5, Dump Truck	09.00 - 11.04	F3BE0681C		4300.90.04 4301.20.00 4326.30.00 8919.40.00	430 10 MFZ430 430WGTZ KZISZ - 5	- Engine code: F3AE0681 - Use release fork with cam
MP 190 E 44 W Cursor K0MB12C5, K0MB12H5, K0MB14C3, K0MB14H5, K0MA12C2, K0MA13C2, K0MB12C3, K0MB12D3, K0MB12H3, K0MB13H3, Platform/Chassis	09.00 - 11.04			4300.90.176 4301.20.00 4326.30.00 8939.40.00	430 10 MFZ430 430WGTZ KZISZ - 5	- Engine code: F3AE0681 - Use release fork with rollers
MP 260 E 38 H Cursor K1LA14C4, K1LA17C4, K1LA16H2, K1LB14C3, K1LA14C2, K1LA14H2, K1LA15C4, K1LA17C2, K1LA17D2, K1LB13C3, Dump Truck	01.01 - 11.04	F3BE0681C F3BE0681G		4300.90.04 4301.20.00 4326.30.00 8919.40.00	430 10 MFZ430 430WGTZ KZISZ - 5	- Engine code: F3AE0681 - Use release fork with cam
MP 260 E 38 H Cursor K1LA12H4, K1LA14C4, K1LA14H4, K1LA15C4, K1LA17C4, K1LA15HA, K1LA16H2, K1LA17H2, K1LA17HC, K1LB14C3, Platform/Chassis	01.01 - 11.04			4300.90.176 4301.20.00 4326.30.00 8939.40.00	430 10 MFZ430 430WGTZ KZISZ - 5	- Engine code: F3AE0681 - Use release fork with rollers
MP 260 E 38 W Cursor K1LA14C4, K1LA17C4, K1LA16H2, K1LB14C3, K1LA14C2, K1LA14H2, K1LA15C4, K1LA17C2, K1LA17D2, K1LB13C3, Dump Truck	01.01 - 11.04					
MP 260 E 38 W Cursor K1LA14C4, K1LA17C4, K1LA16H2, K1LB14C3, K1LA14C2, K1LA14H2, K1LA15C4, K1LA17C2, K1LA17D2, K1LB13C3, Platform/Chassis	01.01 - 11.04					
MP 260 E 44 H Cursor K1MA12C2, K1MA15C4, K1MA17J2, K1MA13D4, K1MB13C3, K1MB14H3, K1MA12D2, K1MA12D4, K1MA13C2, K1MA14C2	01.01 - 11.04					
MP 260 E 44 H Cursor K1MA12C2, K1MA13HA, K1MA15C4, K1MA16H4, K1MA17HA, K1MA17J2, K1MA13CA, K1MA13D4, K1MA15HC, K1MA17HC	01.00 - 11.04					
MP 260 E 44 W Cursor K1MA12C2, K1MA15C4, K1MA17J2, K1MA13D4, K1MB13C3, K1MB14H3, K1MA12D2, K1MA12D4, K1MA13C2, K1MA14C2, Dump Truck	01.01 - 11.04					
MP 260 E 44 W Cursor K1MA12C2, K1MA15C4, K1MA17J2, K1MA13D4, K1MB13C3, K1MB14H3, K1MA12D2, K1MA12D4, K1MA13C2, K1MA14C2, Platform/Chassis	01.01 - 11.04					
MP 340 E 37 H K4EA11B1, K4EA13B1, K4EC13C1, K4EA11BD, K4EA13BD, K4EA13AD, K4EC11B1, K4EC11C1, K4EA11C1, K4EA13A1, K4EC13B1	01.93 - 11.04	8210.42K(TCA) 8210.42K. 8210.42L.		4300.90.02 4301.20.00 4327.30.00 8919.40.00	430 10 MFZ430 430GTZ KZISZ - 5	- GBox: Fuller
MP 340 E 42 H K4FA11B1, K4FD17F1, K4FC11C1, K4FC11B1, K4FA13C1, K4FA11C1	01.93 - 11.04			4300.90.04 4301.20.00 4326.30.00 8919.40.00	430 10 MFZ430 430WGTZ KZISZ - 5	- GBox: ZF - Use release fork with cam
MP 400 E 37 HT K0EA22J1, K0EB22D5, K0EC21J1, K0EA21E1, K0EC21D1, K0EC21F1, K0EC22J1, K0EA21J5, K0EC21A1	01.93 - 11.04					
MP 400 E 37 WT K0EA22J1, K0EB22D5, K0EA21E1, K0EC22J1, K0EA21J5, K0ED22D1	01.93 - 11.04			4300.90.176 4301.20.00 4326.30.00 8939.40.00	430 10 MFZ430 430WGTZ KZISZ - 5	- GBox: ZF - Use release fork with rollers

Vehicle list

					
---	---	---	--	---	---

IVECO

EuroTrakker 01.93 - 11.04

MP 340 E 38 H Cursor K4LA13C2, K4LA12C2, K4LA13JA, K4LA11D2, K4LA13DA, K4LA72C2, K4LA12H2, K4LA13CA, K4LF13CA, K4LA11H2, Dump Truck	01.01 - 11.04	F3BE0681C F3BE0681G		4300.90.04  4301.20.00  4326.30.00  8919.40.00	430 10 MFZ430 430WGTZ KZISZ - 5	- Engine code: F3AE0681 - Use release fork with cam
	01.01 - 11.04			4300.90.176  4301.20.00  4326.30.00  8939.40.00	430 10 MFZ430 430WGTZ KZISZ - 5	- Engine code: F3AE0681 - Use release fork with rollers
MP 340 E 38 H Cursor K4LA14CA, K4LA11H4, K4LA13C2, K4LA14HA, K4LA12C2, K4LA12H4, K4LA13C4, K4LA13H4, K4LA13JA, K4LA11D2, Platform/Chassis	01.01 - 11.04					
MP 340 E 38 HB Cursor K4LA13C2, K4LA71H4, K4LA12C2, K4LA13JA, K4LA71C4, K4LA72C4, K4LA11D2, K4LA13DA, K4LA72C2, K4LA72H2	01.01 - 11.04					
MP 340 E 44 H Cursor K4MA12J2, K4MA11H2, K4MA12C2, K4MA12D2, K4MA13HA, K4MA13J4, K4MA11C2, K4MA13C2, K4MA13H4, K4MA11D2, Dump Truck	01.01 - 11.04					
MP 340 E 44 H Cursor K4MA12J2, K4MA14HA, K4MA11H2, K4MA12C2, K4MA12D2, K4MA12H4, K4MA12C4, K4MA13CC, K4MA13HA, K4MA13J4, Platform/Chassis	01.01 - 11.04					
MP 340 E 44 HB Cursor K4MA12J2, K4MA72C4, K4MA11H2, K4MA12C2, K4MA12D2, K4MA71C4, K4MA73H4, K4MA13HA, K4MA13J4, K4MA72H2	01.01 - 11.04					
MP 380 E 38 W Cursor K3LA13C4, K3LA13D2, K3LA12D2, K3LA13H2, K3LA14D2, K3LA15C2, K3LB13H3, K3LB13H5, K3LB14H5, K3LA13E2	01.01 - 11.04	F3BE0681G		4300.90.04  4301.20.00  4326.30.00  8919.40.00	430 10 MFZ430 430WGTZ KZISZ - 5	- Engine code: F3AE0681 - Use release fork with cam
	01.01 - 11.04			4300.90.176  4301.20.00  4326.30.00  8939.40.00	430 10 MFZ430 430WGTZ KZISZ - 5	- Engine code: F3AE0681 - Use release fork with rollers
MP 380 E 38 H Cursor K3LA13C4, K3LA13D2, K3LA12D2, K3LA13H2, K3LA14D2, K3LA15C2, K3LB13H3, K3LA12C2, K3LA13E2, K3LA14C2, Dump Truck	01.01 - 11.04					
MP 380 E 38 H Cursor K3LA13C4, K3LA13D2, K3LA12D2, K3LA13H2, K3LA14D2, K3LA15C2, K3LB13H3, K3LA12C2, K3LA13E2, K3LA14C2, Platform/Chassis	01.01 - 11.04					
MP 380 E 38 W Cursor K3LA13C4, K3LA13D2, K3LA12D2, K3LA13H2, K3LA14D2, K3LA15C2, K3LB13H3, K3LB13H5, K3LB14H5, K3LA12C2	01.01 - 11.04					
MP 380 E 42 H K3FA13J1, K3FA15J1, K3FB14D1, K3FC14D1, K3FA13D1, K3FA13F1, K3FA15D1, K3FB14E1, K3FA12A1, K3FA13A1, K3FA12D1	01.93 - 11.04	8210.42L.		4300.90.02  4301.20.00  4327.30.00  8919.40.00	430 10 MFZ430 430GTZ KZISZ - 5	- Engine code: 8210 - GBox: Fuller
	01.93 - 11.04			4300.90.04  4301.20.00  4326.30.00  8919.40.00	430 10 MFZ430 430WGTZ KZISZ - 5	- Engine code: 8210 - GBox: ZF - Use release fork with cam
				4300.90.176  4301.20.00  4326.30.00  8939.40.00	430 10 MFZ430 430WGTZ KZISZ - 5	- Engine code: 8210 - GBox: ZF - Use release fork with rollers
MP 380 E 42 W K3FA13J1, K3FA15J1, K3FB14D1, K3FC14D1, K3FA13D1, K3FA13F1, K3FA15D1, K3FB14E1, K3FA12A1, K3FA13A1, K3FA12D1						

Vehicle list

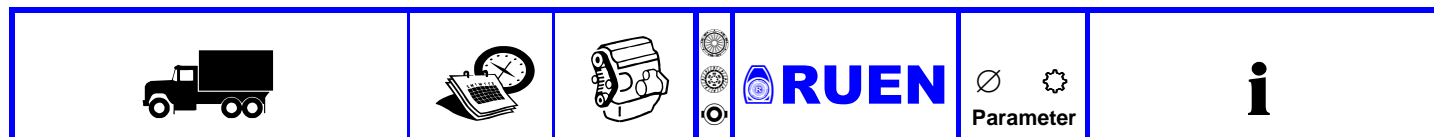







IVECO













EuroTrakker 01.93 - 11.04

MP 380 E 44 H Cursor K3SA15C2, K3SA15C4, K3SA12C4, K3SA12D2, K3SA12D4, K3SA12H2, K3SA13C2, K3SA12C2, K3SA13H4, Dump Truck MP 380 E 44 H Cursor K3SA15C2, K3SA15C4, K3SA12C4, K3SA12D2, K3SA12D4, K3SA12H2, K3SA13C2, K3SA12C2, K3SA13H4, Platform/Chassis MP 380 E 44 W Cursor K3SA15C2, K3SA15C4, K3SA12C4, K3SA12D2, K3SA12D4, K3SA12H2, K3SA13C2, K3SA12C2, K3SA13H4, Dump Truck MP 380 E 44 W Cursor K3MB13H1, K3SA15C2, K3SA15C4, K3MB14M1, K3SA12C4, K3SA12D2, K3SA12D4, K3SA12H2, K3SA13C2, K3MB13M1, Platform/Chassis	01.01 - 11.04	F3BE0681C		4300.90.04 ⊗ 4301.20.00 ⊗ 4326.30.00 ⊙ 8919.40.00	430 10 MFZ430 430WGTZ KZISZ - 5	- Engine code: F3AE0681 - Use release fork with cam	
	01.01 - 11.04				4300.90.176 ⊗ 4301.20.00 ⊗ 4326.30.00 ⊙ 8939.40.00	430 10 MFZ430 430WGTZ KZISZ - 5	- Engine code: F3AE0681 - Use release fork with rollers
MP 400 E 42 HT K0FA21A1, K0FC21D1, K0FC21J1, K0FA21D1, K0FA21K1, K0FA21F1, K0FC21A1, K0FA21J1, K0FC21F1, K0FC22J1 MP 400 E 42 WT K0FA21A1, K0FC21D1, K0FC21J1, K0FA21D1, K0FA21K1, K0FA21F1, K0FA21J1, K0FD22D1 MP 410 E 38 H Cursor K5LA11D2, K5LA12C2, K5LA12D2, K5LA13H2, K5LA73C2, K5LA12H2, K5LA13E2, K5LA11C2, K5LA11H2, K5LA13E3, Dump Truck MP 410 E 38 H Cursor K5LA11D2, K5LA12C2, K5LA12D2, K5LA13H2, K5LA73C2, K5LA12H2, K5LA13E2, K5LA11C2, K5LA11H2, K5LA13E3, Platform/Chassis	01.93 - 11.04	8210.42L(TCA) 8210.42L. F3BE0681G		4300.90.02 ⊗ 4301.20.00 ⊗ 4327.30.00 ⊙ 8919.40.00	430 10 MFZ430 430GTZ KZISZ - 5	- Engine code: 8460 - GBox: Fuller	
	01.93 - 11.04				4300.90.04 ⊗ 4301.20.00 ⊗ 4326.30.00 ⊙ 8919.40.00	430 10 MFZ430 430WGTZ KZISZ - 5	- Engine code: 8460 - GBox: ZF - Use release fork with cam
	01.01 - 11.04				4300.90.176 ⊗ 4301.20.00 ⊗ 4326.30.00 ⊙ 8939.40.00	430 10 MFZ430 430WGTZ KZISZ - 5	- Engine code: 8460 - GBox: ZF - Use release fork with rollers
	01.01 - 11.04				4300.90.176 ⊗ 4301.20.00 ⊗ 4326.30.00 ⊙ 8939.40.00	430 10 MFZ430 430WGTZ KZISZ - 5	- Engine code: 8460 - GBox: ZF - Use release fork with rollers
MP 410 E 42 H K5FA11B1, K5FC11B1, K5FC13B1, K5FC14E1, K5FA11A1, K5FD12B1 MP 410 E 42 W K5FA11B1, K5FC11B1, K5FC13B1, K5FC14E1, K5FA11A1, K5FD12B1	01.93 - 11.04	8210.42L(TCA) 8210.42L.		4300.90.02 ⊗ 4301.20.00 ⊗ 4327.30.00 ⊙ 8919.40.00	430 10 MFZ430 430GTZ KZISZ - 5	- Engine code: 8210 - GBox: Fuller	
	01.93 - 11.04				4300.90.04 ⊗ 4301.20.00 ⊗ 4326.30.00 ⊙ 8919.40.00	430 10 MFZ430 430WGTZ KZISZ - 5	- Engine code: 8210 - GBox: ZF - Use release fork with cam
	01.93 - 11.04				4300.90.176 ⊗ 4301.20.00 ⊗ 4326.30.00 ⊙ 8939.40.00	430 10 MFZ430 430WGTZ KZISZ - 5	- Engine code: 8210 - GBox: ZF - Use release fork with rollers
MP 410 E 44 H Cursor K5MA13H2, K5MA73C2, K5MA11D4, K5MA11H2, K5MA12J4, K5MA14C4, K5MA11C4, K5MA13C2, K5MA14C2, K5MA14J4	01.01 - 11.04	F3BE0681C		4300.90.04 ⊗ 4301.20.00 ⊗ 4326.30.00 ⊙ 8919.40.00	430 10 MFZ430 430WGTZ KZISZ - 5	- Engine code: F3AE0681 - Use release fork with cam	
					4300.90.176 ⊗ 4301.20.00 ⊗ 4326.30.00 ⊙ 8939.40.00	430 10 MFZ430 430WGTZ KZISZ - 5	- Engine code: F3AE0681 - Use release fork with rollers

Vehicle list

					
---	---	---	--	---	---

IVECO

EuroTrakker		01.93 - 11.04				
MP 190 E 30 W K0AB14D1, K0AA13D1, K0AD13D1, K0AA12D1, K0AA15D1, K0AB12D1, K0AC13D1, K0AA14D1, K0AB13D1, K0AA13C1, K0AA16D1	01.93 - 11.04	8460.41C.	 4005.30.00	400 10 400GVZ	- Engine code: 8460	
			 8919.40.00	KZISZ - 5	- Engine code: 8460	
MP 190 E 30 H K0AB14D1, K0AA13D1, K0AD13D1, K0AA12D1, K0AA15D1, K0AB12D1, K0AC13D1, K0AA14D1, K0AB13D1, K0AA13C1, K0AA16D1	01.93 - 11.04					
MP 260 E 30 H K0AC11A1, K0AC11C1, K0AC11G1, K1AA13D1, K1AA16D1, K1AC12E1, K1AC14G1, K1AC14H1, K1AC15A1, K1AC15E1, K1AC16A1	01.93 - 11.04					
MP 190 E 31 H Cursor K0PA12A1, K0PA14A2, K0PB13C1, K0PB14A3, K0PA12A2, K0PA15A1, K0PB12A3, K0PA14A1, K0PB12A1, K0PB13A3, Dump Truck	09.99 - 11.04	F2BE0681B	 4007.30.00	400 10 400WGTZ	- Engine code: F2BE0681 - GBox: 12AS 1800 DD - GBox: 12AS 2301 DD	
			 8919.40.00	KZISZ - 5	- Engine code: F2BE0681 - GBox: 12AS 1800 DD - GBox: 16S 109 - GBox: 9S 109	
MP 190 E 31 W Cursor K0PA12A1, K0PA14A2, K0PB13C1, K0PB14A3, K0PA12A2, K0PA15A1, K0PB12A3, K0PA14A1, K0PB12A1, K0PB13A3, Dump Truck	09.99 - 11.04					
MP 190 E 31 H Cursor K0PA12A1, K0PA14A2, K0PB13C1, K0PB14A3, K0PA12A2, K0PA15A1, K0PB12A3, K0PA14A1, K0PA15D1, K0PB12A1, Platform/Chassis	09.99 - 11.04		 4005.30.00	400 10 400GVZ	- Engine code: F2BE0681 - GBox: 16S 109 - GBox: 9S 109	
			 4300.90.177  4341.20.00  4327.30.00  8919.40.00	430 10 MFZ430 430GTZ KZISZ - 5		
MP 260 E 31 H Cursor K1PA14A2, K1PA14K2, K1PA15AD, K1PA15B1, K1PA17AD, K1PC73JD, K1PA13A2, K1PA14AD, K1PA14GA, K1PA17G2, Dump Truck	09.99 - 11.04					
MP 260 E 31 H Cursor K1PA13D1, K1PA14A2, K1PA14K2, K1PA15AD, K1PA15B1, K1PA17A1, K1PA17AD, K1PC73JD, K1PA13A2, K1PA14AD, Platform/Chassis	09.99 - 11.04					
MP 260 E 31 HB Cursor K1PA14A2, K1PA14K2, K1PA15AD, K1PA15B1, K1PA17AD, K1PA73AD, K1PA74A1, K1PC73JD, K1PA13A2, K1PA14AD	11.99 - 11.04					
MP 190 E 31 W Cursor K0PA12A1, K0PA14A2, K0PB13C1, K0PB14A3, K0PA12A2, K0PA15A1, K0PB12A3, K0PB13A1, K0PB14E1, K0PA14A1, Platform/Chassis	09.99 - 11.04	F2BE0681B	 4007.30.00	400 10 400WGTZ	- Engine code: F2BE0681 - GBox: 12AS 1800 DD	
			 8919.40.00	KZISZ - 5	- Engine code: F2BE0681 - GBox: 12AS 1800 DD - GBox: 9S 109 - GBox: 16S 109	
			 4005.30.00	400 10 400GVZ	- Engine code: F2BE0681 - GBox: 9S 109 - GBox: 16S 109	

Vehicle list

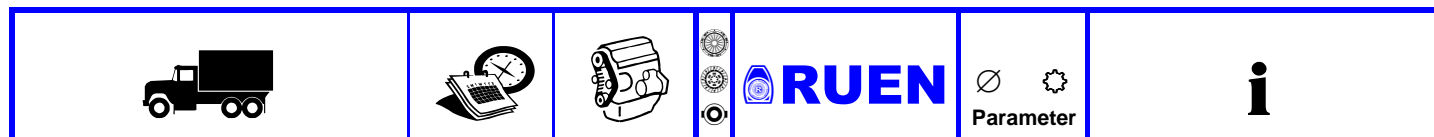

IVECO

EuroTrakker 01.93 - 11.04

MP 190 E 34 H K0BB14B1, K0BC12B1, K0BB12B1, K0BD12B1, K0BA14A1, K0BA14C1, K0BB12A1, K0BA13B1, K0BB13B1, K0BA12B1	01.93 - 11.04	8460.41K. 8460.41K. TCA		4006.30.00	400 10 400GVZ	- Engine code: 8460 - GBox: Fuller
					8919.40.00	KZISZ - 5
MP 190 E 34 W K0BB14B1, K0BC12B1, K0BB12B1, K0BD12B1, K0BA14A1, K0BA14C1, K0BB12A1, K0BA13B1, K0BB13B1, K0BA12B1	01.93 - 11.04			4007.30.00	400 10 400WGTZ	- Engine code: 8460 - GBox: ZF
MP 260 E 34 H K1BB13A1, K1BC12B1, K1BA14C1, K1BA16C1, K1BC16B1, K1BA12D1, K1BB13B1, K1BB14B1, K1BC17DD, K1BA16D1, K1BA17B1	01.93 - 11.04					
MP 260 E 34 W K1BB13A1, K1BC12B1, K1BA14C1, K1BA16C1, K1BC16B1, K1BA12D1, K1BB13B1, K1BB14B1, K1BC17DD, K1BA16D1, K1BA17B1	01.93 - 11.04					
MP 340 E 34 H K4BA11AD, K4BC11B1, K4BA13B1, K4BC13BD, K4BA14AD, K4BA11B1, K4BA13AD, K4BC14BD, K4BA11A1, K4BA13A1, K4BA13BD	01.93 - 11.04					
MP 380 E 34 H K3BA12B1, K3BA14A1, K3BC14B1, K3BD13B1, K3BA13A1, K3BC12B1, K3BA15B1, K3BC15B1, K3BA14B1, K3BB14B1, K3BA12A1	01.93 - 11.04					
MP 400 E 34 HT K0BA21D1, K0BC21B1, K0BC21A1, K0BC21C1, K0BA21B1, K0BC21D1	01.93 - 11.04					
MP 440 E 34 HT K1BC21C1, K1BC22A1, K1BA22C1, K1BC21A1, K1BC22B1, K1BC21D1, K1BC22C1, K1BA21B1, K1BC21B1, K1BC22D1	01.93 - 11.04					

Vehicle list

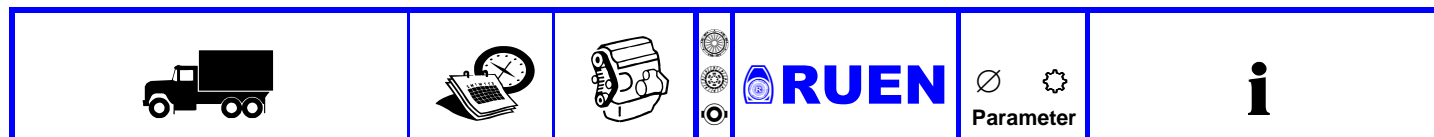

IVECO

EuroTrakker 01.93 - 11.04

MP 190 E 35 H Cursor K0RB14B3, K0RB13A1, K0RA13H1, K0RA14A4, K0RA15A1, K0RA13A1, K0RB13K3, K0RB14D1, K0RA14A2, K0RB14A1, Dump Truck	09.99 - 11.04	F2BE0681A		4007.30.00	400 10 400WGTZ	- Engine code: F2BE0681 - GBox: 16S 151+INT - GBox: 12AS 2301 DD - GBox: 16S 151
MP 190 E 35 H Cursor K0RB14B3, K0RA14D1, K0RB13A1, K0RA13H1, K0RA14A4, K0RA15A1, K0RA13A1, K0RB13K3, K0RB14D1, K0RA14A2, Platform/Chassis	09.99 - 11.04			8919.40.00	KZISZ - 5	- Engine code: F2BE0681 - GBox: 16S 151+INT - GBox: 12AS 2301 DD - GBox: 16S 151 - GBox: 12AS 1800 DD
MP 190 E 35 W Cursor K0RB14B3, K0RB13A1, K0RA13H1, K0RA14A4, K0RA15A1, K0RA13A1, K0RB13K3, K0RB14D1, K0RA14A2, K0RB14A1, Dump Truck	09.99 - 11.04					
MP 190 E 35 W Cursor K0RB14B3, K0RB13A1, K0RA13H1, K0RA14A4, K0RA15A1, K0RA13A1, K0RB12A1, K0RB13K3, K0RB14D1, K0RA14A2, Platform/Chassis	09.99 - 11.04					
MP 260 E 35 H Cursor K1RA13A1, K1RA14N1, K1RA15K2, K1RA17A1, K1RA17A2, K1RA17AA, K1RA17K2, K1RA14A2, K1RA15A1, K1RA74A2, Dump Truck	01.00 - 11.04					
MP 260 E 35 H Cursor K1RA13A1, K1RA13D1, K1RA14N1, K1RA15K2, K1RA16D1, K1RA17A1, K1RA17A2, K1RA17AA, K1RA17K2, K1RA14A2, Platform/Chassis	01.00 - 11.04					
MP 260 E 35 W Cursor K1RA13A1, K1RA14N1, K1RA15K2, K1RA17A1, K1RA17A2, K1RA17AA, K1RA17K2, K1RA14A2, K1RA15A1, K1RA74A2, Dump Truck	09.99 - 11.04					
MP 260 E 35 W Cursor K1RA13A1, K1RA14N1, K1RA15K2, K1RA17A1, K1RA17A2, K1RA17AA, K1RA17K2, K1RA14A2, K1RA15A1, K1RA74A2, Platform/Chassis	09.99 - 11.04					
MP 340 E 35 H Cursor K4RA14A1, K4RA73A1, K4RA73A2, K4RF13KA, K4RA71A1, K4RA13A2, K4RA13AA, K4RA13DD, K4RF14KC, K4RA71A2, Dump Truck	09.99 - 11.04					
MP 340 E 35 H Cursor K4RA14A1, K4RA14D1, K4RA73A1, K4RA73A2, K4RF13KA, K4RA12A1, K4RA71A1, K4RA12AD, K4RA13A2, K4RA13AA, Platform/Chassis	09.99 - 11.04					
MP 340 E 35 HB Cursor K4RA14A1, K4RA73A1, K4RA73A2, K4RF13KA, K4RA71A1, K4RA71D1, K4RA13A2, K4RA13AA, K4RA71C1, K4RA72A1	01.01 - 11.04					

Vehicle list

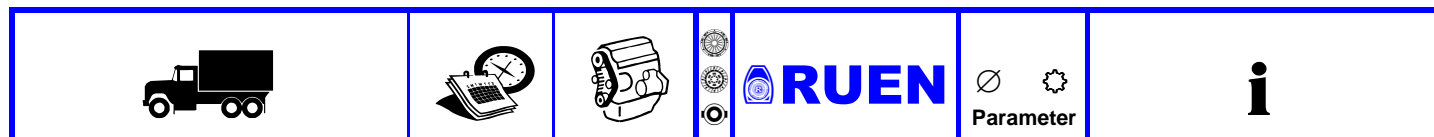

IVECO

EuroTrakker 01.93 - 11.04

MP 380 E 38 HB Cursor K3LA72H2, K3LA74C2, K3LA74H4, K3LA74H2, K3LA73C2, K3LA72C2, K3LA73H2, K3LA74C4	01.01 - 11.04	F3BE0681C F3BE0681E F3BE0681G		4300.90.04 4301.20.00 4326.30.00 8919.40.00	430 10 MFZ430 430WGTZ KZISZ - 5	- Engine code: F3AE0681 - Use release fork with cam
MP 380 E 44 HB Cursor K3MA72H2, K3MA74C2, K3MA74H4, K3MA72C2, K3MA73C2, K3MA74C4, K3MA73H2, K3MA74H2	01.01 - 11.04			4300.90.176 4301.20.00 4326.30.00 8939.40.00	430 10 MFZ430 430WGTZ KZISZ - 5	- Engine code: F3AE0681 - Use release fork with rollers
MP 410 E 44 HB Cursor K5MA71H2, K5MA73C2, K5MA74H2, K5MA71H4, K5MA74H4, K5MA73C4, K5MA72C4, K5MA72H4, K5MA73H4, K5MA74C4	01.01 - 11.04					
MP 440 E 38 HT Cursor K1LA22C2, K1LA22H4, K1LA22HA, K1LA22C4, K1LA22HC, K1LA22H2, K1LA22CA, K1LA22CC	01.01 - 11.04					
MP 440 E 44 HT Cursor K1MA22C2, K1MA22HC, K1MA22C4, K1MA22H4, K1MA22HA, K1MA22CA, K1MA22H2, K1MA22CC	01.01 - 11.04					
MP 720 E 38 HT Cursor K3LA22H4, K3LA22C4, K3LA22H2, K3LA22C2	01.01 - 11.04					
MP 720 E 44 HT Cursor	01.01 - 11.04					
MP 720 E 48 HT Cursor	01.01 - 11.04					
MP 380 E 31 MP 400 E 31 MP 720 E 31				4300.90.177 4341.20.00 4327.30.00 8919.40.00	430 10 MFZ430 430GTZ KZISZ - 5	

M 06.82 - 12.92

159-17	07.82 - 09.86	8360.05.254		3570.20.00	350 GMF350	- GBox: ZF
				3585.30.00	350 10 350GSZ	- GBox: ZF
165-24 R	06.82 - 09.86	8220.22.002		3895.20.00	380 G380KR	
	01.85 - 12.85	8220.22.102				
165-24 T	06.82 - 09.86	8460.21.002		38115.30.00	380 10 380GSZ	
175-24 31631431, 31631511, 31631111, 31631211, 31631411, 31631304, 31631311, 31631531, 31633115, 31631104, 31631204, 31631231	09.86 - 11.92	8460.21.010		8510.40.00	KZI - 4,5	- GBox: ZF
175-24 T 31631431, 31631511, 31631111, 31631211, 31631411, 31631304, 31631311, 31631531, 31633115, 31631104, 31631204, 31631231	09.86 - 11.92			8512.40.00	KZI - 4,5	- GBox: Fuller
115-17 31731211, 31731411, 31731311, 31731111, 31731511	09.83 - 12.85	8060.24.601		7951.40.00	KZIS - 4	- To model year: 11/1985 - Engine code: 8060
135-17 31831204, 31831211, 31831311, 31833105, 31831215, 31831315, 31833111, 31833211, 31831504, 31831205, 31831511, 31832104	09.83 - 12.85					
135-17 T 31831204, 31831211, 31831311, 31833105, 31831215, 31831315, 31833111, 31833211, 31831504, 31831205, 31831511, 31832104	09.83 - 12.85					

MK 01.83 - 12.91

75-9 A 17131312, 17131212	01.83 - 05.89	BF4L 913 T		2820.20.00	280 MF280	
75-9 H 17131312, 17131212	01.83 - 08.85	F4L 913		2832.30.00	280 10 280GTZ	
				6904.40.00	KZI-3	

Vehicle list



IVECO

MK 01.83 - 12.91

80-13 A 37051152, 37611212, 37051452, 37053152, 37611312, 37611412, 37613112, 37051252, 37611112, 37611512, 37612112, 37031212 80-13 A 80-13 AH 37051152, 37611212, 37051452, 37053152, 37611312, 37611412, 37613112, 37051252, 37611112, 37611512, 37612112, 37031212 80-13 AT 37051152, 37611212, 37051452, 37053152, 37611312, 37611412, 37613112, 37051252, 37611112, 37611512, 37612112, 37031212 90-13 A 37673132, 37671232, 37671412, 37671432, 37673112, 37671312, 37671212, 37671332 90-13 AH 37673132, 37671232, 37671412, 37671432, 37673112, 37671312, 37671212, 37671332 110-13 A 37251592, 37251272, 37251472, 37251292, 37251372, 37251392, 37251492, 37251572 110-13 AH 37251592, 37251272, 37251472, 37251292, 37251372, 37251392, 37251492, 37251572	01.83 - 12.91	BF6L 913 T F6L 913		3166.20.00	310 MF310		
					3113.30.00	310 10 310GSBL	
					6904.40.00	KZI-3	
80-13 AW 37651232, 37651312, 37651412, 87211152, 37651532, 37651132, 37651212, 37653132, 37651332, 37653112, 87211172, 37651432 80-13 AW 37651232, 37651312, 37651412, 37651532, 37651132, 37651212, 37653132, 37651332, 37653112, 37651432, 37652132	01.83 - 12.91	BF6L 913 T F6L 913		3169.20.00	310 MF310		
					3113.30.00	310 10 310GSBL	
					6904.40.00	KZI-3	
80-16 A 37731332, 37731412, 37731432, 87231312, 37731232, 37731312, 37731212, 87231332, 7.49t 80-16 A 37731332, 37731412, 37731432, 87231312, 37731232, 37731312, 37731212, 87231332, 8.00t 80-16 AW 37731332, 37731412, 37731432, 87231312, 37731232, 37731312, 37731212, 87231332, 7.49t 80-16 AW 37731332, 37731412, 37731432, 87231312, 37731232, 37731312, 37731212, 87231332, 8.00t 110-16 A 37351492, 37351372, 37351592, 37351272, 37351472, 37351572, 37351292, 37351392 110-16 AH 37353192, 37353172 110-16 AT	01.83 - 12.91	BF6L 913 F6L 913		3570.20.00	350 GMF350		
					3585.30.00	350 10 350GSZ	
					6904.40.00	KZI-3	
130-13 A 37271372, 37271492, 37271272, 37271292, 37271392, 37271472 130-13 AH 37273172, 37273192	01.83 - 12.91	BF6L 913 T F6L 913		3166.20.00	310 MF310		
					3113.30.00	310 10 310GSBL	
					6904.40.00	KZI-3	
130-16 A 37371492, 37371272, 37371392, 37371292, 37372192, 37371472, 37372172, 37371372 130-16 AH 37373172, 37373192	01.83 - 12.91	BF6L 913		3570.20.00	350 GMF350		
					3585.30.00	350 10 350GSZ	
					6904.40.00	KZI-3	

Vehicle list



IVECO

OM 35 - 616

OM 35	01.85 -			2514.20.00	250 H250K	
OM 40 /35	05.76 - 12.85			2514.30.00	250 10 250CBL	
OM 40	05.76 -					
OM 45	01.85 -					
OM 50	01.85 -					
OM 616	05.76 -					
OM 55				2810.20.00	280 H280K	
OM 65				2810.30.00	280 10 280CBL	
OM 70						
OM 75						

P/PA 12.79 - 12.93

159-17 H	07.82 - 09.86	8360.05.254		3570.20.00	350 GMF350	- GBox: ZF
				3585.30.00	350 10 350GSZ	- GBox: ZF
				6904.40.00	KZI-3	- GBox: ZF
160-23 AH	04.84 - 05.89	F8L 413 F		4237.20.00	420 GF420KR	
				8514.40.00	KZI - 4,5	
				4289.30.00	420 10 420GSZ	- For PTO
160-23 AHW	01.85 - 12.85	F8L 413 F		3895.20.00	380 G380KR	
				38115.30.00	380 10 380GSZ	
				8514.40.00	KZI - 4,5	
160-23 AHW	04.84 - 05.89	F8L 413 F		3895.20.00	380 G380KR	- To model year: 01.1986
				38115.30.00	380 10 380GSZ	- To model year: 01.1986
				4237.20.00	420 GF420KR	- From model year: 02.1986
				4208.30.00	420 10 420GS	- From model year: 02.1986
				8514.40.00	KZI - 4,5	
				4289.30.00	420 10 420GSZ	- From model year: 02.1986 - For PTO
160-30 AH, 17.00t, Platform/Chassis 160-30 AH, 17.00t, Dump Truck 160-30 AHW	06.86 - 05.89	BF8L 513		4253.20.00	420 GFX420KR	- GBox: ZF
	06.86 - 05.89			4268.30.00	420 10 420GSZ	- GBox: ZF
	06.86 - 05.89			8514.40.00	KZI - 4,5	- GBox: ZF
170-23 AH 68911212, 69111312, 69111212, 68911312	04.88 - 12.90	F8L 513		4237.20.00	420 GF420KR	
				4208.30.00	420 10 420GS	
				8514.40.00	KZI - 4,5	
170-23 AHW 68911212, 69111312, 69111212, 68911312 170-23 AHW,180-23 AHW 68911212, 69111312, 69111212, 68911312	04.88 - 12.90	F8L 513		3895.20.00	380 G380KR	- GBox: ZF
	01.91 - 12.93			38115.30.00	380 10 380GSZ	- GBox: ZF
				8514.40.00	KZI - 4,5	- GBox: ZF
				4237.20.00	420 GF420KR	- GBox: ZF
				4208.30.00	420 10 420GS	- GBox: ZF

Vehicle list

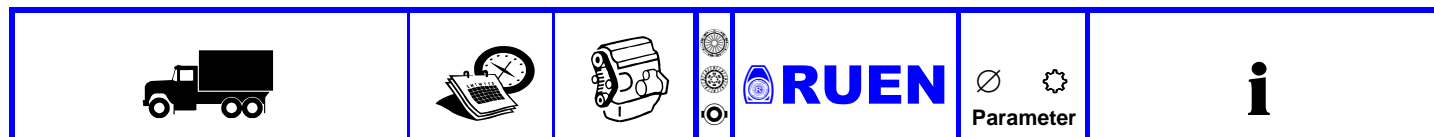

IVECO

P/PA		12.79 - 12.93				
170-23 AH,180-23 AH 68911212, 69111312, 69111212, 68911312 170-34 AH 69151212, 68951112, 68951212, 68951312, 69151112, 17.00t, Platform/Chassis 170-34 AH 69151212, 68951112, 68951212, 68951312, 69151112, 17.00t, Dump Truck 170-34 AH 69151212, 68951112, 68951212, 68951312, 69151112 170-34 AHW 69151212, 68951112, 68951212, 68951312, 69151112 170-34 AH,180-34 AH 69151212, 68951112, 68951212, 68951312, 69151112 170-34 AHW,180-34 AHW 69151212, 68951112, 68951212, 68951312, 69151112	01.91 - 12.93	BF8L 513		4253.20.00	420 GFX420KR	
	04.89 - 12.90	F8L 513		4268.30.00	420 10 420GSZ	
	04.89 - 12.90			8514.40.00	KZI - 4,5	
	01.91 - 12.93					
	04.89 - 12.90					
	01.91 - 12.93					
	01.91 - 12.93					
170-25 AH 68931212, 68931312, 69131312, 69131212 170-25 AHW 68931212, 68931312, 69131312, 69131212 170-25 AH,180-25 AH 68931212, 68931312, 69131312, 69131212	03.89 - 12.90	F8L 513		4237.20.00	420 GF420KR	- GBox: ZF
	03.89 - 12.90			4208.30.00	420 10 420GS	- GBox: ZF
	01.91 - 12.93			8514.40.00	KZI - 4,5	- GBox: ZF
170-25 AHW,180-25 AHW 68931212, 68931312, 69131312, 69131212	01.91 - 12.93	F8L 513		4289.30.00	420 10 420GSZ	- For PTO
				4237.20.00	420 GF420KR	- GBox: ZF
				4208.30.00	420 10 420GS	- GBox: ZF
				8514.40.00	KZI - 4,5	- GBox: ZF
190-25 AH, 16.00t, Platform/Chassis 190-25 AH, 16.00t, Dump Truck 190-25 AH, 19.00t, Dump Truck 190-25 AHW, 16.00t, Dump Truck 190-25 AHW, 19.00t, Dump Truck	07.83 - 06.86	F8L 413 F		4237.20.00	420 GF420KR	- GBox: ZF
	07.83 - 06.86			4208.30.00	420 10 420GS	- GBox: ZF
	07.83 - 06.86			8514.40.00	KZI - 4,5	- GBox: ZF
	07.83 - 06.86					
	07.83 - 06.86					
190-30 H 60031152, 60031255, 60131112, 60031155, 60031252, 60032152, 60131115, 17.00t, Platform/Chassis 190-30 H 60031152, 60031255, 60131112, 60031155, 60031252, 60032152, 60131115, 18.00t, Platform/Chassis 190-30 H 60031152, 60031255, 60131112, 60031155, 60031252, 60032152, 60131115, 17.00t, Dump Truck 190-30 H 60031152, 60031255, 60131112, 60031155, 60031252, 60032152, 60131115, 18.00t, Dump Truck	04.87 - 12.90	8210.22.210		4278.20.00	420 GFX420KR	- GBox: Fuller
		8210.22.236		4268.30.00	420 10 420GSZ	- GBox: Fuller
	01.91 - 12.92	8210.22.511		8514.40.00	KZI - 4,5	- GBox: Fuller
		8210.22.521				
		8210.22.523				
		8210.22.525				
	04.87 - 12.90	8210.22.535				
190-30 HT 60031152, 60031255, 60131112, 60031155, 60031252, 60032152, 60131115	01.89 - 12.90	8210.22.210		4278.20.00	420 GFX420KR	
	01.90 - 12.92	8210.22.236		4268.30.00	420 10 420GSZ	
		8210.22.511				
		8210.22.521				
		8210.22.523				
		8210.22.525				
		8210.22.535				
		8210.22.537				

Vehicle list



IVECO

P/PA		12.79 - 12.93					
190-30 HW 60031152, 60031255, 60131112, 60031155, 60031252, 60032152, 60131115	04.87 - 12.90	8210.22.210		4278.20.00	420 GFX420KR		
	01.91 - 12.92	8210.22.236		4268.20.00	420 GMF420K		
		8210.22.511		8510.40.00	KZI - 4,5		
		8210.22.521					
		8210.22.523					
8210.22.525							
8210.22.535							
8210.22.537							
190-32 AH, 16.00t, Platform/Chassis 190-32 AH, 16.00t, Dump Truck 190-32 AH, 19.00t, Dump Truck 190-32 AHW, 16.00t, Dump Truck 190-32 AHW, 19.00t, Dump Truck	01.83 - 12.85	F10L 413 F		4298.20.00	420 GF420		
	01.83 - 12.85			4268.30.00	420 10 420GSZ		
	01.83 - 12.85			8514.40.00	KZI - 4,5		
	01.83 - 12.85						
	01.83 - 12.85						
260-25 AH 69031312, 69037112, 69031332, 69037212, 68711112, 68811212, 22.00t, Platform/Chassis 260-25 AH 69031312, 69037112, 69031332, 69037212, 68711112, 68811212, 22.00t, Dump Truck 260-25 AH 69031312, 69037112, 69031332, 69037212, 68711112, 68811212, 26.00t, Dump Truck 260-25 AH 69031312, 69037112, 69031332, 69037212, 68711112, 68811212, 24.00t, Utility truck 260-25 AH 69031312, 69037112, 69031332, 69037212, 68711112, 68811212, 26.00t, Utility truck 260-25 AHW, 22.00t, Dump Truck 260-25 AHW, 26.00t, Dump Truck	03.84 - 06.86	F8L 413 F		4237.20.00	420 GF420KR	- GBox: ZF	
	03.84 - 06.86	F8L 513		4208.30.00	420 10 420GS	- GBox: ZF	
				8514.40.00	KZI - 4,5	- GBox: ZF	
	03.84 - 06.86						
	04.89 - 12.92						
	04.89 - 12.92						
	03.84 - 06.86						
	03.84 - 06.86						
	260-25 AHB 69031312, 69037112, 69031332, 69037212, 68711112, 68811212, 22.00t, Concrete Mixer 260-25 AHB 69031312, 69037112, 69031332, 69037212, 68711112, 68811212, 26.00t, Concrete Mixer 260-25 AHB 69031312, 69037112, 69031332, 69037212, 68711112, 68811212, 22.00t, Concrete Mixer 260-25 AHB 69031312, 69037112, 69031332, 69037212, 68711112, 68811212, 26.00t, Concrete Mixer	12.79 - 10.85	F8L 413 F		3895.20.00	380 G380KR	- GBox: ZF
		12.79 - 10.85			38115.30.00	380 10 380GSZ	- GBox: ZF
				8514.40.00	KZI - 4,5	- GBox: ZF	
03.84 - 06.86							
03.84 - 06.86							

Vehicle list

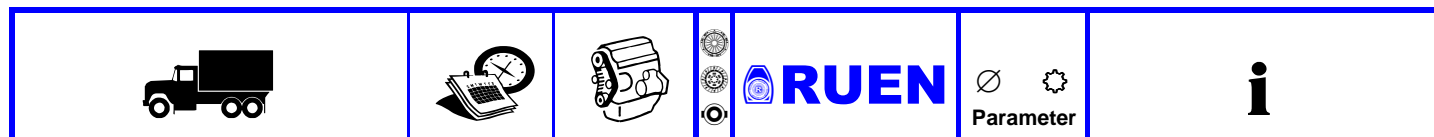

IVECO

P/PA		12.79 - 12.93					
260-30 AH, 24.00t, Platform/Chassis	06.86 - 05.90	BF8L 513		4253.20.00	420 GFX420KR	- GBox: ZF	
260-30 AH, 24.00t, Dump Truck	06.86 - 05.90			4268.30.00	420 10 420GSZ	- GBox: ZF	
260-30 AH, 26.00t, Dump Truck	06.86 - 05.90			8514.40.00	KZI - 4,5	- GBox: ZF	
260-30 AHT, 24.00t, Truck Tractor	06.86 - 05.90						
260-30 AHT, 26.00t, Truck Tractor	06.86 - 05.90						
260-30 AHW, 24.00t, Dump Truck	06.86 - 05.90						
260-30 AHW, 26.00t, Dump Truck	06.86 - 05.90						
260-34 AH 69052112, 69051112, 69051412, 67651212, 69051312, 24.00t, Platform/Chassis	04.89 - 12.90						
260-34 AH 69052112, 69051112, 69051412, 67651212, 69051312, 25.00t, Platform/Chassis	01.91 - 12.92						
260-34 AH 69052112, 69051112, 69051412, 67651212, 69051312, 24.00t, Dump Truck	04.89 - 12.90						
260-34 AH 69052112, 69051112, 69051412, 67651212, 69051312, 25.00t, Dump Truck	01.91 - 12.92						
260-34 AH 69052112, 69051112, 69051412, 67651212, 69051312, 26.00t, Dump Truck	04.89 - 12.90						
260-34 AHT, 24.00t, Truck Tractor	04.89 - 12.90						
260-34 AHT, 25.00t, Truck Tractor	01.91 - 12.92						
260-34 AHT, 26.00t, Truck Tractor	04.89 - 12.90						
260-34 AHW	01.91 - 12.92						
260-32 AH, 22.00t, Platform/Chassis	01.83 - 12.85		F10L 413 F		4298.20.00	420 GF420	- GBox: ZF
260-32 AH, 22.00t, Dump Truck	01.83 - 12.85				4268.30.00	420 10 420GSZ	- GBox: ZF
260-32 AH, 26.00t, Dump Truck	01.83 - 12.85				8514.40.00	KZI - 4,5	- GBox: ZF
260-32 AHT, 22.00t, Truck Tractor	01.83 - 12.85						
260-32 AHT, 26.00t, Truck Tractor	01.83 - 12.85						
260-32 AHW, 22.00t, Dump Truck	01.83 - 12.85						
260-32 AHW, 26.00t, Dump Truck	01.83 - 12.85						
300-30 AH	04.87 - 05.89	BF8L 513		4253.20.00	420 GFX420KR		
300-30 AHB	04.87 - 05.89			4268.30.00	420 10 420GSZ		
				8514.40.00	KZI - 4,5		

Vehicle list

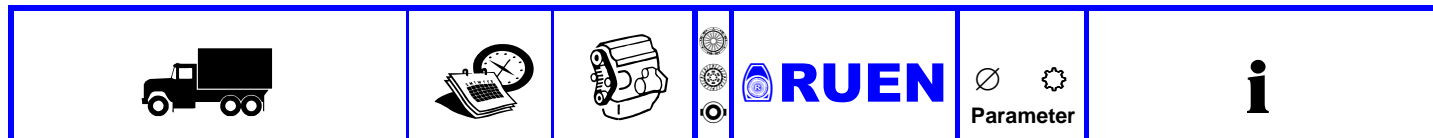

IVECO

P/PA		12.79 - 12.93				
330-30 H 60371255, 60372155, 60371355, 60372255, 60371252, 60372152, 60371242, 60371245, 60371352, 60372245, 60531212, 60531312	01.88 - 12.90	8210.22X.235		4278.20.00	420 GFX420KR	
		8210.22X.523		4250.30.00	420 10 420WGSZ	
	01.91 - 12.92			4268.30.00	420 10 420GSZ	
	06.84 - 12.90 06.84 - 12.92			8514.40.00	KZI - 4,5	
330-30 HT 60371255, 60372155, 60371355, 60372255, 60371252, 60372152, 60371242, 60371245, 60371352, 60372245, 60531212, 60531312, 24.00t, Truck Tractor	01.88 - 12.90					
	01.91 - 12.92					
	01.88 - 12.90					
	01.88 - 12.92					
330-30 HT 60371255, 60372155, 60371355, 60372255, 60371252, 60372152, 60371242, 60371245, 60371352, 60372245, 60531212, 60531312, 26.00t, Truck Tractor	01.88 - 12.90					
	01.88 - 12.92					
	01.88 - 12.90					
	01.88 - 12.92					
330-30 HW 60371255, 60372155, 60371355, 60372255, 60371252, 60372152, 60371242, 60371245, 60371352, 60372245, 60531212, 60531312, 24.00t, Dump Truck	01.88 - 12.90	8210.22X.235		4278.20.00	420 GFX420KR	
		8210.22X.523		4268.30.00	420 10 420GSZ	
	01.91 - 12.92					
	01.88 - 12.90					
330-30 HW 60371255, 60372155, 60371355, 60372255, 60371252, 60372152, 60371242, 60371245, 60371352, 60372245, 60531212, 60531312, 26.00t, Dump Truck	01.88 - 12.90					
	01.88 - 12.92					
	01.88 - 12.90					
	01.88 - 12.92					
330-36 HT 61211112, 61211205, 60551312, 61211215, 61211312, 61211315, 61212115, 61212212, 61211212, 61212112, 61212215, 60551212, 24.00t, Truck Tractor	01.89 - 12.90	8210.42.210		4300.90.42 ⊕	430 10	- GBox: ZF
		8210.42.235		4334.60.00	MFZ430	- GBox: Fuller
		8210.42.237		4326.30.00	430WGTZ	
		8210.42.269		4309.26.00 ⊖	430 MFZ430	- GBox: ZF - GBox: Fuller - Contained in xxxx.60.00
	8210.42.270					
	8210.42.271			8930.40.00	KZI/Z-5	- GBox: ZF - GBox: Fuller - Contained in xxxx.60.00

Vehicle list

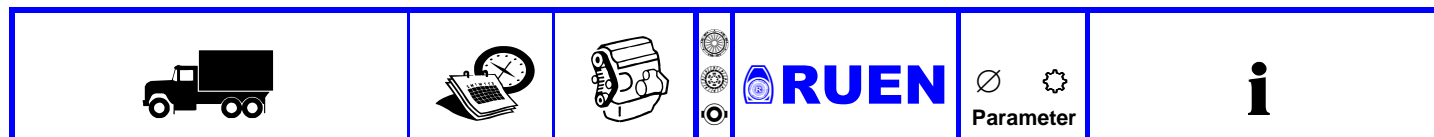

IVECO

P/PA 12.79 - 12.93

330-36 H 61211112, 61211205, 60551312, 61211215, 61211312, 61211315, 61212115, 61212212, 61211212, 61212112, 61212215, 60551212, 24.00t, Dump Truck	01.89 - 12.90	8210.42.210 8210.42.235 8210.42.237 8210.42.269		4300.90.42 ⊕ 4334.60.00 4326.30.00	430 10 MFZ430 430WGTZ	- GBox: ZF
	01.91 - 12.92	8210.42.270 8210.42.271		4300.90.36 ⊕ 4334.60.00 4327.30.00	430 10 MFZ430 430GTZ	- GBox: Fuller
	01.89 - 12.90			4309.26.00 ⊖	430 MFZ430	- GBox: ZF - GBox: Fuller - Contained in xxxx.60.00
	01.89 - 12.92			8930.40.00	KZI/Z-5	- GBox: ZF - GBox: Fuller - Contained in xxxx.60.00
330-36 H 61211112, 61211205, 60551312, 61211215, 61211312, 61211315, 61212115, 61212212, 61211212, 61212112, 61212215, 60551212, 26.00t, Dump Truck	01.89 - 12.92					
330-36 HT 61211112, 61211205, 60551312, 61211215, 61211312, 61211315, 61212115, 61212212, 61211212, 61212112, 61212215, 60551212	01.91 - 12.92					
330-36 HT 61211112, 61211205, 60551312, 61211215, 61211312, 61211315, 61212115, 61212212, 61211212, 61212112, 61212215, 60551212, 26.00t, Truck Tractor	01.89 - 12.90					
330-36 HT 61211112, 61211205, 60551312, 61211215, 61211312, 61211315, 61212115, 61212212, 61211212, 61212112, 61212215, 60551212	01.89 - 12.92					
330-36 HW 61211112, 61211205, 60551312, 61211215, 61211312, 61211315, 61212115, 61212212, 61211212, 61212112, 61212215, 60551212, 24.00t, Dump Truck	01.89 - 10.90					
330-36 HW 61211112, 61211205, 60551312, 61211215, 61211312, 61212115, 61212212, 61211212, 61212112, 61212215, 60551212, 26.00t, Dump Truck	01.89 - 10.90					
330-36 HW 61211112, 61211205, 60551312, 61211215, 61211312, 61211315, 61212115, 61212212, 61211212, 61212112, 61212215, 60551212	01.89 - 12.92					
	01.91 - 12.92					
340-34 AH 69253112	03.89 - 12.92	BF8L 513		4278.20.00	420 GFX420KR	
				4268.30.00	420 10 420GSZ	
				8514.40.00	KZI - 4,5	

P/PA-Haubenfahrzeuge 12.79 - 12.93

120-13 ANW 77711215, 77731212, 77731112, 77711115	01.83 - 09.90	BF6L 913 T F6L 913		6904.40.00	KZI-3	
120-16 ANW, 120-17 ANW	01.83 - 11.89	BF6L 913		6904.40.00	KZI-3	
				3536.20.00	350 GF350K	- For: Version 42231628 - For: Version 42231929
				3583.30.00	350 10 350GSZ	- For: Version 42231628 - For: Version 42231929
				8514.40.00	KZI - 4,5	- For: Version 42231628 - For: Version 42231929

Vehicle list



IVECO

P/PA-Haubenfahrzeuge 12.79 - 12.93

150-16 AN	01.83 - 12.91	BF6L 913		3570.20.00	350 GMF350	- GBox: ZF
150-16 ANW	01.83 - 12.91			3585.30.00	350 10 350GSZ	- GBox: ZF
160-17 AN 78831332, 78911332	07.89 - 12.93	BF6L 913		3563.20.00	350 GMF350	
160-17 ANW 78831332, 78911332	07.89 - 12.93	BF6L 913/U		3583.30.00	350 10 350GSZ	
				8514.40.00	KZI - 4,5	
160-23 ANW, 16.00t, Dump Truck	04.84 - 12.85	F8L 413 F		3895.20.00	380 G380KR	
160-23 ANW	01.86 - 05.89	F8L 513		38115.30.00	380 10 380GSZ	
160-23 ANW, 19.00t, Dump Truck	04.84 - 12.85			8514.40.00	KZI - 4,5	
160-23 ANW, 16.00t, Utility truck	04.84 - 12.85					
160-23 ANW	01.88 - 05.89					
170-23 ANW	04.88 - 12.90					
170-23 ANW 79011212, 79011232, 18.00t, Dump Truck	01.91 - 12.93					
170-23 ANW 79011212, 79011232	01.90 - 12.90					
170-23 ANW 79011212, 79011232, 18.00t, Utility truck	01.91 - 12.93					
190-25 ANT	07.86 - 12.87					
190-25 AN 77011232, 77012132, 77012135, 77111232, 77111252, 77031215, 77011335, 77031315, 77032115, 77131215, 77011235	07.83 - 12.86	F8L 413 F		4237.20.00	420 GF420KR	- To model year: 11.1984
				4208.30.00	420 10 420GS	- To model year: 11.1984
190-25 AN 77011232, 77012132, 77012135, 77111232, 77111252, 77031215, 77011335, 77131215, 77031315, 77032115, 77011235	07.83 - 12.87			8514.40.00	KZI - 4,5	- To model year: 11.1984
190-25 ANT	07.83 - 06.86					
190-25 ANW	07.83 - 12.86	F8L 413 F		4237.20.00	420 GF420KR	
	07.83 - 12.87			4208.30.00	420 10 420GS	- To model year: 11.1984
				4268.30.00	420 10 420GSZ	- From model year: 12.1984
				8514.40.00	KZI - 4,5	
190-25 ANW	01.86 - 09.90	F8L 413 F		4237.20.00	420 GF420KR	
				4268.30.00	420 10 420GSZ	
				8514.40.00	KZI - 4,5	
190-30 N 70131215, 70131315, 70132112, 70131212, 70131312, 70132115	04.87 - 12.90	8210.22.175		4278.20.00	420 GFX420KR	- GBox: Fuller
	01.91 - 12.93			4268.30.00	420 10 420GSZ	- GBox: Fuller
190-30 NT 70132132, 70131232, 70131332	04.87 - 12.90			8514.40.00	KZI - 4,5	- GBox: Fuller
	01.91 - 12.93					
260-25 AN, 22.00t, Dump Truck	07.83 - 06.86	F8L 413 F		3895.20.00	380 G380KR	- GBox: ZF
260-25 AN, 26.00t, Dump Truck	07.83 - 06.86			38115.30.00	380 10 380GSZ	- GBox: ZF
				8514.40.00	KZI - 4,5	- GBox: ZF
				4237.20.00	420 GF420KR	- GBox: ZF
				4208.30.00	420 10 420GS	- For: ANW - GBox: ZF
				4268.30.00	420 10 420GSZ	- For: AN - GBox: ZF

Vehicle list



IVECO

P/PA-Haubenfahrzeuge		12.79 - 12.93				
260-25 ANW, 22.00t, Dump Truck 260-25 ANW, 26.00t, Dump Truck	07.83 - 06.86	F8L 413 F	4237.20.00	420 GF420KR	- GBox: ZF	
	07.83 - 06.86		4208.30.00	420 10 420GS	- GBox: ZF	
			8514.40.00	KZI - 4,5	- GBox: ZF	
330-30 AN 77331115, 77251212, 77331112, 77251315, 77251112, 77251215, 77251115, 24.00t, Dump Truck 330-30 AN 77331115, 77251212, 77331112, 77251315, 77251112, 77251215, 77251115, 26.00t, Dump Truck 330-30 AN 77331115, 77251212, 77331112, 77251315, 77251112, 77251215, 77251115, 33.00t, Dump Truck 330-30 ANW 77251117, 77251317, 77331117, 24.00t, Dump Truck 330-30 ANW 77251117, 77251317, 77331117, 26.00t, Dump Truck 330-30 ANW 77251117, 77251317, 77331117, 33.00t, Dump Truck	05.86 - 09.90	BF8L 513	4268.30.00	420 10 420GSZ	- GBox: Fuller	
	05.86 - 09.90		8514.40.00	KZI - 4,5	- GBox: Fuller	
	05.86 - 09.90					
	05.86 - 09.90					
	05.86 - 09.90					
	05.86 - 09.90					
	05.86 - 09.90					
	05.86 - 09.90					
330-30 N 70351212, 70431115, 70431112, 70351112, 70351215, 70351315, 70351115, 24.00t, Dump Truck 330-30 N 70351212, 70431115, 70431112, 70351112, 70351215, 70351315, 70351115 330-30 N 70351212, 70431115, 70431112, 70351112, 70351215, 70351315, 70351115, 26.00t, Dump Truck 330-30 N 70351212, 70431115, 70431112, 70351112, 70351215, 70351315, 70351115, 33.00t, Dump Truck	10.87 - 12.90	8210.22X.069 8210.22X.575	4278.20.00	420 GFX420KR		
	01.91 - 12.92		4268.30.00	420 10 420GSZ		
	10.87 - 12.90		8514.40.00	KZI - 4,5		
	10.87 - 12.90		4236.20.00	420 GF420KR		
	10.87 - 12.92					
330-30 NW 70351132, 70351232, 70431122, 70451115, 70371315, 70431132, 70371215, 70371115, 24.00t, Dump Truck 330-30 NW 70351132, 70351232, 70431122, 70451115, 70371315, 70431132, 70371215, 70371115 330-30 NW 70351132, 70351232, 70431122, 70451115, 70371315, 70431132, 70371215, 70371115, 26.00t, Dump Truck 330-30 NW 70351132, 70351232, 70431122, 70451115, 70371315, 70431132, 70371215, 70371115, 33.00t, Dump Truck	10.87 - 12.90	8210.22X.069 8210.22X.575	4278.20.00	420 GFX420KR		
	01.91 - 12.92		4268.30.00	420 10 420GSZ		
	10.87 - 12.90					
	10.87 - 12.92					
	10.87 - 12.92					
330-30 ANW			4300.20.00	430 MFZ430		
			4326.30.00	430 10 430WGTZ		
			8919.40.00	KZISZ - 5		
160-23 ANW	04.85 - 12.85	F8L 413 F	3801.20.00	380 G380KR		
			3816.30.00	380 10 380GSZ		
			8514.40.00	KZI - 4,5		

Vehicle list





					
---	---	---	--	---	---





IVECO





Sirius

Sirius K			 2802.20.00	280 G280	
Sirius S					

Stralis 02.02 -

190S40 190S43 190S48 AS		F3BE0681	 4300.90.04  4301.20.00  4326.30.00  8919.40.00	430 10 MFZ430 430WGTZ KZISZ - 5	- GBox: 16S-181 - GBox: 12AS 2301DD
-------------------------------	--	----------	--	---	--

AS 260S40 L3LB16D3, L3LB17D3, L7LB15D3, LCLC15D3, LCLC16D3, LCLC16G3, LCLCL6BA, LCLE16F1, LCLE17B1, LCLE19E1, LCLF17E1, L3LB15D3	02.02 -	F3AE0681B F3AE0681D F3AE0681H F3BE0681A F3BE0681E	 4300.90.04  4301.20.00  4326.30.00  8919.40.00	430 10 MFZ430 430WGTZ KZISZ - 5	- GBox: 16AS 2601 DD
AS 260S43 L3KB16D3, L3KC16G1, L3KFL6G3, L7KB18D3, LCKC15D3, LCKC17D3, LCKE14A1, LCKE16A1, LCKE17F1, LCKF16A1, LCKF17A1, L3KB15D3	02.02 -	F3BE0681E			
AS 260S44	02.02 -				
AS 260S48 L3PB16D3, L3PB18G3, L3PFL7KB, L7PB16K3, LJPC15A1, LJPC16A1, LJPC16H1, LJPC17HA, LJPE14E1, LJPE15A1, LJPE15H1, LJPE16H1	02.02 -				
AS 260S54 L7RB15B3, L3RC15B3, L7RB17B3, LJRE18B3, L3RB15B3, L3RB16B3, L3RB17B3, L3RE16A1, L3RB18B3, L3RC17B3, L7RB16B3	02.02 -				













AS 440S40 LALCT1A1, LALCT1AA, L2LB21G1, LALB23E1, LALCT1E1, L1LB21D1, L1LB21F1, L1LB21G1, L1LB23C1, L1LB23D1, LALB21AA, L1LCT1G1	02.02 -	F3AE0681B F3AE0681D F3AE0681H F3BE0681A F3BE0681E	 4300.90.04  4301.20.00  4326.30.00  8919.40.00	430 10 MFZ430 430WGTZ KZISZ - 5	- GBox: 16S-221 - GBox: 16AS 2601DD
AS 440S40 LALCT1A1, L2LB21G1, LALB23E1, LALCT1E1, L1LB21D1, L1LB21F1, L1LB21G1, L1LB23C1, L1LB23D1, L1LCT1G1, L1LB21C1, L1LB23DA	02.02 -	F3BE0681E			
AS 440S43 L1KB21G1, L2KB21GA, LAKB21E1, LAKB23E1, LAKCT1EA, L2KB21G1, LAKB21AA, LAKCT1A1, LAKCT1AA, L1KB21C1, L1KB23FA, L1KB23G1, Truck Tractor, 4x2	02.02 -				
AS 440S43 L1KB21G1, L2KB21GA, LAKB21E1, LAKB23E1, L2KB21G1, LAKCT1A1, L1KB21C1, L1KB23FA, L1KB23G1, L1KCT1D1, LAKBH3A1, LBKB21A1, Truck Tractor, 6x2/4	02.02 -				
AS 440S44					
AS 440S48 L1PCT1K1, LGPB21C1, LGPB21E1, LGPB23C1, LGPCT1C1, LGPCT1EA, LHPB21E1, L1PB21C1, L1PB23C1, L1PB23G1, L1PCT1J1, LGPB23AA	02.02 -				
AS 440S48 L1PCT1K1, LGPB21E1, LGPCT1C1, LHPB21AA, LHPB21E1, L1PB21C1, L1PB23C1, L1PB23G1, L1PCT1J1, L1PB21F1, LHPB21A1, L1PCT1B1	02.02 -				
AS 440S54 L1RB21B1, LGRB21G1, LGRB21GA, L1RB23BA, L1RCT1B1, L1RB23B1, LGRM23M1, LGRB21M1, LGRB23G1, LGRB23GA, LGRM23MA, L1RB21A1	02.02 -				

Vehicle list







					
---	---	---	--	---	---

IVECO















Stralis 02.02 -

Stralis Euro 6			 4300.90.109  4390.20.00  4390.30.00  8939.40.00	4300 10 MFZ430 430WGTZ KZISZ - 5	- Engine code: Cursor 11 - Engine code: Cursor 13 - Equipment Var: 480 PS - Equipment Var: 500 PS - Equipment Var: 560 PS
260S35 AD	02.02 -	F2BE0681A	 4007.30.00	400 10 400WGTZ	- Engine code: F2BE0681 - GBox: 9S,16S,12AS - GBox: 16S-109,12AS-2301 DD
260S35 AT					
AD 190S35	04.04 -		 8919.40.00	KZISZ - 5	- Engine code: F2BE0681 - GBox: 9S,16S,12AS
AD 260S35	04.04 -				
AS 440S35 AD					
460S36 T	04.12 -	F2BE3681B	 4300.90.68	430 10 MFZ430 430WGTZ KZISZ - 5	- Engine code: F2BE3681 - Engine code: Cursor 9 - GBox: 12AS-1930 TD - GBox: 12AS-1420 TD - Use release fork with rollers
530S36 T	04.12 -	F2CFE611A	 4303.20.00		
AD 190S33, AT 190S33 6ABB13A1, 6ABB16E1, QABB13A1, QABB18E1, 6ABB19E1, 6ABB19E3, QABA13A1, 6ABB17E1, 6ABB19B3, QABB17E1	12.06 -	F2CFE611B	 4331.30.00  8939.40.00		
AD 190S36, AT 190S36 2ACB16D1, 2ACB17B2, 2ACB18B1, 2ACB18D1, 2ACCD7D1, 2ACCDLB1, 2ACCDLD2, 2ACCU8B2, 2ACCD7B2, 2ACCD8B2	01.13 -				
AD 190S40, AT 190S40 2ADB13B2, 2ADB13D1, 2ADB15B1, 2ADB15B2, 2ADB15D2, 2ADB17B1, 2ADB17B2, 2ADB18D2, 2ADCD5D1, 2ADCD7B2	01.13 -				
AD 260S36, AT 260S36 2ECB13B1, 2ECB14D2, 2ECB19B1, 2ECCD7B2, 2ECCU4B1, 2ECCU7B1, 2ECB13D1, 2ECB13D2, 2ECB16B2, 2ECB19D1	01.13 -				
AD 260S36, AT 260S36 2DCB14B1, 2DCB14E2, 2DCB15D2, 2DCCD4B2, 2ECE14B2, 2ECE15B2, 2ECE17D2, 2ECE19D2, 2ECFD6D2, 2ECFD7B2	01.13 -				
AD 260S40, AT 260S40 2EDB14B1, 2EDB15D2, 2EDB18D1, 2EDCD3D2, 2EDCD4B1, 2EDCD4D1, 2EDCD5D2, 2EDCD8D1, 2EDCU5B2, 2EDCU7B1	01.13 -				
AD 260S40, AT 260S40 2DDB14D2, 2DDCD4B2, 2EDE14B1, 2EDE15D1, 2EDE16D2, 2EDE18D2, 2EDE19B2, 2EDFD6D1, 2EDFD7B1, 2EDFU5B2	01.13 -				
AD 190S27, AT 190S27 MDHA14B1, MDHA17B1, MDHB16FA, MDHB1MB1, MDHG17FA, MDHG19BA, NDHA16B1, NDHA18B1, NDHB16B1, NDHB16F1	06.03 -	F2BE0681B F2BE0681C F2BE0681E	 4007.30.00	400 10 400WGTZ	- Engine code: F2BE0681 - GBox: 12AS
AD 190S30, AD 190S31, AT 190S31 6AAA19A1, 6AAB18A1, 6AAB18EA, 6AAB19B1, 6AAB19BC, 6AACD7B1, MDPA14A1, MDPA14G1, MDPA15A1	06.03 -	F2BE0681F F2BE3681C	 8919.40.00	KZISZ - 5	- Engine code: F2BE0681 - GBox: 12AS - GBox: 9S, 16S - GBox: 9S-109 - GBox: 16S-109
AD 260S31, AT 260S31 MEPG15C1, MFPB14F1, MFPB16B1, MFPB16BA, MFPB16FA, MFPB17BA, MFPE11F1, MFPE17F1, MFPG17BA, MGPA15B1	06.03 -		 4005.30.00	400 10 400GVZ	- Engine code: F2BE0681 - GBox: 9S, 16S - GBox: 9S-109 - GBox: 16S-109

Vehicle list

					
---	---	---	--	---	---

IVECO

Stralis		02.02 -					
AD 190S31, AT 190S31 2AAB14B2, 2AAB14C1, 2AAB15C1, 2AAB16C1, 2AAB16C2, 2AAB17B2, 2AAB17C1, 2AAB18A2, 2AAB18C1, 2AAB18D1 AD 190S33, AT 190S33 2ABB14C2, 2ABB14D1, 2ABB17D2, 2ABB19C2, 2ABCD4A1, 2ABCD6E1, 2ABCD7B1, 2ABCD8C1, 2ABCDLC1, 2ABCDLD1 AD 260S31, AT 260S31 AD 260S31, AT 260S31 2EAB18D2, 2EAB19A1, 2EACD4A1, 2EACD4D1, 2EACD5B2, 2EACD5E2, 2EACD6D1, 2EACD6E1, 2EACD7C1, 2EACD7D2 AD 260S31, AT 260S31 2DACD5C1, 2DACD5C2, 2EAE14E2, 2EAE15D1, 2EAE15D2, 2EAE16D2, 2EAE17A2, 2EAE17C2, 2EAE18B1, 2EAFD3C1 AD 260S33, AT 260S33 2EBB15D1, 2EBB16B1, 2EBB16B2, 2EBB17C1, 2EBB18D2, 2EBB19B2, 2EBCD4A1, 2EBCD4D1, 2EBCD4E2, 2EBCD5D1 AD 260S33, AT 260S33 2DBCD4C1, 2DBCD5A1, 2DBCD5C1, 2DBCD5E1, 2EBE11E1, 2EBE13B1, 2EBE13D2, 2EBE14A2, 2EBE14E2, 2EBE15B1	01.13 - 01.13 - 04.04 - 01.13 - 01.13 - 01.13 - 01.13 -	F2BE3681C F2CFE611C F2CFE611D	   	4300.90.68 4303.20.00 4331.30.00 8939.40.00	430 10 MFZ430 430WGTZ KZISZ - 5	- Engine code: Cursor 9 - GBox: 16 S 1620 TD, 12 AS 1420 TD, 12 AS 1930 TD - GBox: 12 AS 2330 TO - Use release fork with rollers	
					4339.30.00	430 10 430WGTZ	- Engine code: Cursor 9 - GBox: 9 S 1310TO
					8542.40.00	KZIS-4	- Engine code: Cursor 9 - GBox: 9 S 1310TO
AD 190S33, AT 190S33 AD 190S36, AT 190S36 AD 260S36, AT 260S36	05.07 - 05.07 - 07.07 -	F2BE3681A F2BE3681B	   	4300.90.68 4303.20.00 4331.30.00 8939.40.00	430 10 MFZ430 430WGTZ KZISZ - 5	- GBox: 12AS 2301 DD - Use release fork with rollers	
					4300.90.94 4303.20.00 4331.30.00 8919.40.00	430 10 MFZ430 430WGTZ KZISZ - 5	- GBox: 12AS 2301 DD - Use release fork with cam
AD 190S35, AT 190S35, AD 190S36, AT 190S36 6ACB1LA3, 6ACCD8A3, 6ACCD8B3, MDRA16B1, MDRA18B1, MDRB19E1, MDRG16B1, MDRG16E1	06.03 -	F2BE0681A F2BE3681A		4007.30.00	400 10 400WGTZ	- Engine code: F2BE0681 - GBox: 12AS-2301 DD - GBox: 16S-151	
				8919.40.00	KZISZ - 5	- Engine code: F2BE0681 - GBox: 12AS-2301 DD - GBox: 16S-151	
				4300.90.68 4303.20.00 4331.30.00 8939.40.00	430 10 MFZ430 430WGTZ KZISZ - 5	- Engine code: F2BE3681 - GBox: 12AS-1930TD - Use release fork with rollers	
				4300.90.94 4303.20.00 4331.30.00 8919.40.00	430 10 MFZ430 430WGTZ KZISZ - 5	- Engine code: F2BE3681 - GBox: 16S-1620TD - Use release fork with cam	

Vehicle list

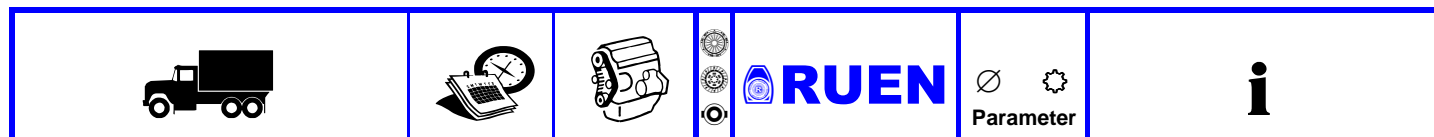







IVECO

Stralis 02.02 -

AD 190S40, AT 190S40 MLLA15A1, MLLB17AA, MLLB17EA, MLLB19E1, MLLG15A1, MLLG15AA, MLLG16A1, MLLG1ME1, NLLA16B1, NLLB15AA AD 190S43, AT 190S43 NLKG16EA, NLKG17A1, NLKG18AA, MLKB16A1, MLKB16EA, MLKB17E1, MLKG16A1, MLKG19AA, MLKG1MEA, NLKA15B1 AD 190S48, AT 190S48, AS 190S48 1AGB17B1, 1AGB18D1, 2FGB16D2, 2FGB18B2, 2FGCD5B1, 2FGCD5D1, 2FGCU8B2, 1AGB17D1, 1AGB1LB1 AD 260S40, AT 260S40 MMLB15AA, MMLB15E1, MMLB16E1, MMLE13EA, MMLE14EA, MMLF14EA, MMLG16A1, MMLH14AA, MMLH15E1, MNLB16A1 AS 190S40 L1LB15D3, L1LB19D3, LDLCL7A1, L1LB15G3, LDLB18E1, LDLB18A1, LDLC18A1, LDLC17E1, L1LB17D3, LDLB19E1, LDLC18A1, LDLC18E1 AS 190S43 L1KB18G3, L1KB15D3, L1KB19D3, L1KB18D3, L1KB17D3, L1KB15G3, L1KB17G3 AS 190S48 LKPB18A1, LKPB18E1, LKPCL8C1, LKPB15M1, LKPC18E1, LKPC18M1, LKPCL8G1, LKPCL7E1, LKPCL7G1, LKPCL8E1, LKPB19E1, LKPCL7M1	03.03 - 06.03 - 01.13 - 06.03 - 02.02 - 02.02 - 02.02 -	F3AE0681B F3AE0681D F3AE0681H F3BE0681E F3GFE611A	 	4300.90.04 4301.20.00 4326.30.00 8919.40.00	430 10 MFZ430 430WGTZ KZISZ - 5	- Engine code: F3AE0681 - GBox: 16S-181 - GBox: 12AS-2301DD - Use release fork with cam
					4300.90.176 4301.20.00 4326.30.00 8939.40.00	430 10 MFZ430 430WGTZ KZISZ - 5
AD 190S42, AT 190S42, AS 190S42 4ADCLLB3, QFDA14A1, QFDB1MA1, TFDB13B1, TFDCD7B1, ZADB18B1, 6FDB14A1, QFDB13B1, QFDB18B1	07.06 -	F3AE3681B F3AE3681D	 	4300.90.68 4303.20.00 4331.30.00 8939.40.00	430 10 MFZ430 430WGTZ KZISZ - 5	- Engine code: F3AE3681 - GBox: 12AS-1930TD - Use release fork with rollers
				4300.90.175 4303.20.00 4339.30.00 8939.40.00	430 10 MFZ430 430WGTZ KZISZ - 5	- Engine code: F3AE3681 - GBox: 16S-1920TD





















Vehicle list

					
---	---	---	--	---	---

IVECO

Stralis

02.02 -

AD 190S42, AT 190S42, AS 190S42 1AEB18D1, 1AEB19B1, 2FEB14B2, 2FEB14D1, 2FEB18D2, 2FEB1LD2, 2FEC3B1, 2FEC3B2, 2FEC3D1	01.13 -	F3AE3681Y F3GFE611A F3GFE611B F3GFE611D	 4300.90.109  4390.20.00  4390.30.00  8939.40.00	4300 10 MFZ430 430WGTZ KZISZ - 5	- Engine code: Cursor 11 - Engine code: Cursor 13 - GBox: 16 S 1920 TD, 16 S 2220 TO, 12 AS 1930 TD - GBox: 12 AS 2330 TD, 12 AS 2330 TO - GBox: 16 S 2220 TD, 16 S 2220 TO - GBox: 12 AS 2330 TD, 12 AS 2330 TO - Use release fork with rollers
AD 190S46, AT 190S46, AS 190S46 4AECU8B3, 6FEB15B3, 6FECNLB3, 6FEB14B3, 6FEB15A1, 6FEB1MB3, 6FECNLBC, 4AEB16B3, 6FEC3D2	01.13 -				
AD 190S46, AT 190S46, AS 190S46 1AFB14B1, 1AFB15B1, 1AFB15D1, 1AFB18B1, 1AFB18D1, 1AFB19B1, 2FFB13D2, 2FFB15B1, 2FFCD3D2	01.13 -				
AD 260S42, AT 260S42 1EEE13D1, 1EEE17B1, 1EEE18D1, 1EEE19B1, 2KEE13B2, 2KEE16D2, 2KEE17D2, 2KEE18D2, 2KEE19D1, 2KEE19D2	01.13 -				
AD 260S42, AT 260S42, AS 260S42 1EEB13D1, 1EEB18B1, 1EEB18D1, 1EECL6B1, 1EECU7D1, 1EECU9D1, 2KEB13B2, 2KEB16D1, 2KEB18B2	01.13 -				
AD 260S46, AT 260S46, AS 260S46 1DFB16B1, 1DFB16D1, 1DFB18B1, 1EFB13B1, 1EFCL6D1, 1EFCL7B1, 2KFB14D2, 2KFB16B2, 2KFB16D1	01.13 -				
AD 260S46, AT 260S46, AS 260S46 1EFE17B1, 1EFE18B1, 1EFL6B1, 1EFFU5D1, 2KFE15B2, 2KFE16D2, 2KFE18B2, 2KFE19D2, 2KFFD3B2	01.13 -				
AD 440S42, AT 440S42, AS 440S42 1BEB21B1, 2GEE23D3, 1BECT1D1, 2GEB23B2, 2GEBH1D1, 2GEB1D1, 2GEB1D2, 2GEB1D3, 2GEB1D4	01.13 -				
AD 440S46, AT 440S46, AS 440S46 1BFB21B1, 1BFE23B2, 2GFB21D1, 2GFBS1B1, 1BFBH1B1, 1BFE21B2, 2GFB21B2, 2GFBH3B2, 2GFBH3D2	01.13 -				
AD 440S46, AT 440S46, AS 440S46 1FFB21B1, 2MFB22B2, 2MFB22D2, 1FFB22D1, 1FFB21D1, 1FFB22B1	01.13 -				
AD 440S48, AT 440S48, AS 440S48 1BGBH3D1, 1BGCT1D1, 1BGE21B2, 1BGE21D2, 2GGBS3D1, 2GGE23D3, 1BGB23B1, 1BGE23B2, 2GGB23B2	01.13 -				
AD 440S48, AT 440S48, AS 440S48 1FGB22B1, 1FGB22D1, 2MGB22B2, 1FGB21B1, 2MGB22D2, 1FGB21D1	01.13 -				
AT 440S46 2JFGH2B2, 2JFGH2D2	01.13 -				
AT 440S48 2JGGH2B2, 2JGGH2D2	01.13 -				
AD 190S45, AT 190S45 TFEC3D1, TFEC3D2, TFEC3D3, TFEC3D4, TFEC3D5, TFEC3D6, TFEC3D7, TFEC3D8, TFEC3D9, TFEC3D10, TFEC3D11, TFEC3D12, TFEC3D13, TFEC3D14, TFEC3D15, TFEC3D16, TFEC3D17, TFEC3D18, TFEC3D19, TFEC3D20, TFEC3D21, TFEC3D22, TFEC3D23, TFEC3D24, TFEC3D25, TFEC3D26, TFEC3D27, TFEC3D28, TFEC3D29, TFEC3D30, TFEC3D31, TFEC3D32, TFEC3D33, TFEC3D34, TFEC3D35, TFEC3D36, TFEC3D37, TFEC3D38, TFEC3D39, TFEC3D40, TFEC3D41, TFEC3D42, TFEC3D43, TFEC3D44, TFEC3D45, TFEC3D46, TFEC3D47, TFEC3D48, TFEC3D49, TFEC3D50, TFEC3D51, TFEC3D52, TFEC3D53, TFEC3D54, TFEC3D55, TFEC3D56, TFEC3D57, TFEC3D58, TFEC3D59, TFEC3D60, TFEC3D61, TFEC3D62, TFEC3D63, TFEC3D64, TFEC3D65, TFEC3D66, TFEC3D67, TFEC3D68, TFEC3D69, TFEC3D70, TFEC3D71, TFEC3D72, TFEC3D73, TFEC3D74, TFEC3D75, TFEC3D76, TFEC3D77, TFEC3D78, TFEC3D79, TFEC3D80, TFEC3D81, TFEC3D82, TFEC3D83, TFEC3D84, TFEC3D85, TFEC3D86, TFEC3D87, TFEC3D88, TFEC3D89, TFEC3D90, TFEC3D91, TFEC3D92, TFEC3D93, TFEC3D94, TFEC3D95, TFEC3D96, TFEC3D97, TFEC3D98, TFEC3D99, TFEC3D100	12.06 -	F3AE3681A	 4300.90.68  4303.20.00  4331.30.00  8939.40.00  4300.90.94  4303.20.00  4331.30.00  8919.40.00  4300.90.175  4303.20.00  4339.30.00  8939.40.00  4300.90.178  4303.20.00  4334.30.00  8919.40.00	430 10 MFZ430 430WGTZ KZISZ - 5	- Engine code: F3AE3681 - GBox: 12AS-2330TD - Use release fork with rollers - Engine code: F3AE3681 - GBox: 12AS-2330TD - Use release fork with cam - Engine code: F3AE3681 - GBox: 16S-2220TD - GBox: ZF16S-1920TD

Vehicle list



IVECO

Stralis		02.02 -				
AD 260S27 CNG, AT 260S27 CNG MQEE15A1, MQHE15A3, MQHE16D3, MQHE17D1, MQHE15A1, MQHE16D1, MQHE17A3, MQHE17D3, MQEE14DA, MQEE17D1	01.08 -	F2BE0641	4005.30.00	400 10 400GVZ	- GBox: 3200R	
			8919.40.00	KZISZ - 5	- GBox: 3200R	
			4300.90.94 4303.20.00 4331.30.00 8919.40.00	430 10 MFZ430 430WGTZ KZISZ - 5	- GBox: 16S - Use release fork with cam	
AD 260S27, AT 260S27 MFHB14FA, MFHB16F1, MFHB16FA, MFHB17F1, MFHB18B1, MFHB18FA, MFHE14B1, MFHE14BA, MFHE15FA, MFHE16B1 AD 440S31, AT 440S31 MCPB21B1, MCPB23F1, MCPB23B1, NCPB23FA, NCPB21B1, MCPB21FA, MCPB23BA, NCPB21F1, NCPB23F1, NCPB21BA	04.04 -	F2BE0681B F2BE0681F	4005.30.00	400 10 400GVZ	- GBox: 9S, 16S, 12AS	
	06.03 -		8919.40.00	KZISZ - 5	- GBox: 9S, 16S	
AD 260S35, AT 260S35, AD 260S36, AT 260S36 MFRB15BA, MFRB18BA, MFRE14B1, MFRG14B1, MFRG18B1, MFRH17F1, MGRB15FA, MGRB18F1	06.03 -	F2BE0681A F2BE3681A	4300.90.94 4303.20.00 4331.30.00 8919.40.00	430 10 MFZ430 430WGTZ KZISZ - 5	- GBox: 16S 109 - Use release fork with cam	
AD 260S42, AT 260S42 QKDE15B1, ZDDB15A1, QKDE13A1, QKDE13B1, QKDE19A1, QKDE17AA, QKDB15A1, QKDE14B1, ZDDB16B1, ZDDE15B1 AD 260S42, AT 260S42, AS 260S42 AD 260S45, AT 260S45 AD 260S45, AT 260S45, AS 260S45 AD 440S42, AT 440S42 TGDB21A1, TGDB21B1, TGDB21BA, TGDB23A1, TGDCM3BA, QGDB21A1, TGDCM3B1, ZBDB21A1, TGDE21A2, ZEDB21A1 AD 440S45, AT 440S45 TGE21B1, TGE21A1, TGE21AA, TGE23B1, TGE23BA, TGE23BA, TGE23BA, TGE23BA, TGE23BA, TGE23BA, TGE23BA, TGE23BA, TGE23BA, AS 440S42 ZBDB21A1, ZBDB21BA, ZBDB23B1, ZBDB21AA, ZBDB23A1, ZBDB23AA, ZBDB23BA, ZBDB21B1 AS 440S42 AS 440S42, AT 440S42 AS 440S45 ZBEB21BA, ZBEB23A1, ZBEB21A1, ZBEB21B1, ZBEB23AA, ZBEB21AA, ZBEB23BA, ZBEB23B1 AS 440S45, AT 440S45, Truck Tractor, 6x2 AS 440S45, AT 440S45, Truck Tractor, 6x4	12.06 -	F3AE3681A F3AE3681B F3AE3681D	4300.90.175 4303.20.00 4339.30.00 8939.40.00	430 10 MFZ430 430WGTZ KZISZ - 5	- Engine code: F3AE3681 - GBox: 16S-1920TD - GBox: 16S-2220TD	
	05.07 - 12.06 - 05.07 - 04.06 - 12.06 - 05.06 - 07.06 - 12.06 - 12.06 - 12.06 - 12.06 - 12.06 -			4300.90.178 4303.20.00 4334.30.00 8919.40.00	430 10 MFZ430 430GTZ KZISZ - 5	- GBox: ZF16S-1920TD
AD 260S42, AT 260S42 AD 320S36 6YCB18B1, 6XCE19B1, 6YCB16B1, 6YCB18B3 AD 440S33, AT 440S33	12.06 -	F2BE3681A	4300.90.68 4303.20.00 4331.30.00 8939.40.00	430 10 MFZ430 430WGTZ KZISZ - 5	- GBox: 16S 109 - GBox: 12AS - Use release fork with rollers	
	01.13 -	F2BE3681B	4300.90.94 4303.20.00 4331.30.00 8919.40.00	430 10 MFZ430 430WGTZ KZISZ - 5	- GBox: 12 AS, 16S 109 - Use release fork with cam	
	12.06 -	F3AE3681B	4300.90.178 4303.20.00 4334.30.00 8919.40.00	430 10 MFZ430 430GTZ KZISZ - 5	- GBox: 16S 109	

Vehicle list

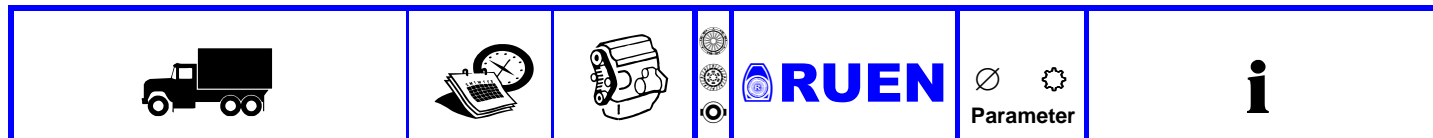









































IVECO

Stralis		02.02 -			
AD 260S43, AT 260S43 LCKE14A1, LCKE15AA, LCKE16A1, MMGK15EA, MMKH15EA, MMKH16A1, MNKB16A1, MNKB17AA, MNKB18AA, NMKE14AA, AD 440S40, AT 440S40 MJLB21A1, MJLB21EA, MJLB21AA, MJLB21E1 AD 440S42, AT 440S42, AS 440S42 1FEB21D1, 1FEB22B1, 2MEB22B2, 2MEB22D2, 1FEB21B1, 1FEB22D1 AS 260S48 AS 260S54 AS 440S40 NJLB21E1, LBLB21A1, NJLB21A1, NJLB21EA, LBLB21AA, LBLB21E1, LBLB21EA, NJLB21AA AS 440S48 AS 440S54 L2RB21B1, L2RB21BA	06.03 -	F3AE0681B F3AE0681D F3AE0681H	4300.90.04 4301.20.00 4326.30.00 8919.40.00	430 10 MFZ430 430WGTZ KZISZ - 5	- GBox: 16S 181, 12AS 2301 DD - GBox: 12AS 1930 TD, 16 S 1920 TD - Use release fork with cam
	03.03 -	F3BE0681A	4300.90.176 4301.20.00 4326.30.00 8939.40.00	430 10 MFZ430 430WGTZ KZISZ - 5	- GBox: 16S 181, 12AS 2301 DD - GBox: 12AS 1930 TD, 16 S 1920 TD - Use release fork with rollers
	01.13 -	F3GFE611D	4300.90.178 4303.20.00 4334.30.00 8919.40.00	430 10 MFZ430 430GTZ KZISZ - 5	- GBox: ZF16S-1920TD
	02.02 - 02.02 - 02.02 - 02.02 - 02.02 -				
AD 260S48, AT 260S48, AS 260S48 1EGB17D1, 1EGB19B1, 1EGCL5B1, 1EGCL6B1, 1EGCL6D1, 1EGCU9D1, 2KGB14B1, 2KGC4D2, 2KGC7B2	01.13 -	F3GFE611A	4300.90.04 4301.20.00 4326.30.00 8919.40.00	430 10 MFZ430 430WGTZ KZISZ - 5	- GBox: 12AS/16AS/16S - Use release fork with cam
			4300.90.109 4390.20.00 4390.30.00 8939.40.00	4300 10 MFZ430 430WGTZ KZISZ - 5	- GBox: 12AS 2330 TD, 16S 2220TD - Use release fork with rollers
			4300.90.94 4303.20.00 4331.30.00 8919.40.00	430 10 MFZ430 430WGTZ KZISZ - 5	- GBox: 12AS 2601 DD - Use release fork with cam
			4300.90.176 4301.20.00 4326.30.00 8939.40.00	430 10 MFZ430 430WGTZ KZISZ - 5	- GBox: 12AS/16AS/16S - Use release fork with rollers
AD 320S42, AT 320S42 6WDE18A1, QWDE14B3, QWDE16A3, TWDE16B3, TWDE18B3, QWDE15A3, QWDE17B3, TWDE16A3, QWDE16B3, QWDE17A3	05.07 -	F3AE3681D	4300.90.68 4303.20.00 4331.30.00 8939.40.00	430 10 MFZ430 430WGTZ KZISZ - 5	- GBox: 12AS - Use release fork with rollers
			4300.90.94 4303.20.00 4331.30.00 8919.40.00	430 10 MFZ430 430WGTZ KZISZ - 5	- GBox: 12AS - Use release fork with cam
			4300.90.178 4303.20.00 4334.30.00 8919.40.00	430 10 MFZ430 430GTZ KZISZ - 5	- GBox: 16S
			4300.90.179 4303.20.00 4331.30.00 8939.40.00	430 10 MFZ430 430WGTZ KZISZ - 5	- GBox: 16S







Vehicle list

					
---	---	---	--	---	---

IVECO















Stralis		02.02 -						
AD 320S45, AT 320S45, AD 320S46, AT320S46 TZE15A3, TWEE17A3, TWEE18B3, 6WEE16A1, QZEB14A3, QZEB18B3, TZE18A3, 6ZEB15A1	05.07 -	F3AE3681A	 4300.90.68	430 10 MFZ430 430WGTZ KZISZ - 5	- GBox: 12AS - GBox: 12AS / 16AS - Use release fork with rollers			
			 4303.20.00					
			 4331.30.00					
			 4300.90.94	430 10 MFZ430 430WGTZ KZISZ - 5	- GBox: 12AS - GBox: 12AS / 16AS - Use release fork with cam			
			 4303.20.00					
			 4331.30.00					
			 4300.90.179	430 10 MFZ430 430WGTZ KZISZ - 5	- GBox: 16S			
			 4303.20.00					
			 4331.30.00					
AD 440S35, AT 440S35, AD 440S36, AT 440S36 MCRB21F1, MCRC21B1, NCRE23F1, MCRB23BA, MCRB21BA, NCRB23F1, MCRB23FA, MCRC21F1	06.03 -	F2BE0681A F2BE3681A	 4007.30.00	400 10 400WGTZ	- GBox: 12AS / 16S			
			 8919.40.00			KZISZ - 5	- GBox: 12AS / 16S	
						 4005.30.00	400 10 400GVZ	- GBox: 12AS / 16S
						 4300.90.94	430 10 MFZ430 430WGTZ KZISZ - 5	- GBox: 12AS / 16S - GBox: 9S - Use release fork with cam
			 4303.20.00					
			 4331.30.00					
AS 190S45 AS 260S43	12.06 -	F3AE0681D	 4300.90.175	430 10 MFZ430 430WGTZ KZISZ - 5	- Engine code: F3AE3681 - GBox: 16S-2220TD - GBox: 16S-1920TD			
	05.05 -	F3AE3681A	 4303.20.00					
			 4339.30.00					
			 8939.40.00					
AS 190S50 1GHB13D1, 1GHB16D1, ZFFCU8B1, 1GHB18B1, 1GHB1LD1, 1GHB1MD1, 1GHCL7B1, 1GHCL7D1, 1GHCLLD1, ZFFB16A1, 1GHB15B1, 1GHB18D1 AS 320S50 4XFE16A3, 4XFE17A3, ZXFB17B3, ZXFE14B3, ZXFE15B3, 4XFE18B3, 4XFE17B3, 4XFE15B3, ZXFE16A3, 4XFE19B3, ZXFB16A3, ZXFE15A3 AS 440S50 1PHB22B1, 1PHB21D1, 1PHB21B1, 1PHB22D1	12.06 -	F3B3681B F3HFE611B	 4300.90.109	4300 10 MFZ430 430WGTZ KZISZ - 5	- Engine code: F3BE3681 - GBox: 12AS-2330TD - Use release fork with rollers			
			 4390.20.00					
			 4390.30.00					
	05.07 -			 4300.90.110	430 10 MFZ430 430WGTZ KZISZ - 5	- Engine code: F3BE3681 - GBox: 12AS-2330TD - GBox: 16S-2320TD		
				 4390.20.00				
				 4390.30.00				
07.06 -			 8919.40.00					
AS 260S50 1JHB14B1, 1JHB16B1, 1JHB16D1, 1NHB14B1, 1NHCU5B1, 1NHCU9D1, 1JHB13B1, 1JHB15B1, 1JHB19B1, 1NHB17B1, 1NHB18D1, 1NHB19B1 AS 260S56 1JLB17D1, 1NLB16D1, 1NLCU5B1, 1NLB18D1, 1NLCU9D1, 1NLB17B1, 1NLCU6D1, 1NLCU8D1, 1NLCU9B1, 1JLB15B1, 1JLB18D1, 1JLB19D1	12.06 -	F3B3681A F3B3681B F3HFE611A F3HFE611B	 4300.90.110	430 10 MFZ430 430WGTZ KZISZ - 5	- GBox: 12AS / 16AS			
			 4390.20.00					
			 4390.30.00					
	12.06 -			 8919.40.00				
	AS 440S56 1PLB21B1, 1PLB22D1, 1PLB22B1, 1PLB21D1	07.06 -	F3B3681A F3HFE611A	 4300.90.04	430 10 MFZ430 430WGTZ KZISZ - 5	- GBox: 16S - Use release fork with cam		
				 4301.20.00				
 4326.30.00								
				 4300.90.109	4300 10 MFZ430 430WGTZ KZISZ - 5	- GBox: 12AS - Use release fork with rollers		
				 4390.20.00				
				 4390.30.00				
				 8939.40.00				
				 4300.90.176	430 10 MFZ430 430WGTZ KZISZ - 5	- GBox: 16S - Use release fork with rollers		
				 4301.20.00				
			 4326.30.00					
			 8939.40.00					

Vehicle list













					
---	---	---	--	---	---

IVECO

Stralis 02.02 -

AT 440S42	07.06 -	F3AE3681B	 4300.90.175  4303.20.00  4339.30.00  8939.40.00	430 10 MFZ430 430WGTZ KZISZ - 5	- Engine code: F3AE3681 - GBox: 16S-1920TD
			 4300.90.178  4303.20.00  4334.30.00  8919.40.00	430 10 MFZ430 430GTZ KZISZ - 5	
450S33 T AD 190S31, AT 190S31	04.12 - 04.04 -	F2BE3681C F2CFE611C	 4339.30.00	430 10 430WGTZ	- Engine code: Cursor 9 - GBox: 9 S 1310TO
			 8542.40.00	KZIS-4	- Engine code: Cursor 9 - GBox: 9 S 1310TO
AD 440S43, AT 440S43 LAKB21E1, LAKB23E1, MHKBH1AA, MHKBH1EA, MHKBH3A1, NHKBH1A1, NHKBH3AA, NHKBH3EA, NHKCM3AA, NHKB21A1 AD 440S43, AT 440S43 NJKB21E1, NJKB21AA, MJKB21AA, NJKB21A1, MJKB21E1, MJKB21EA, MJKB21A1, NJKB21EA AT 440S43 AT 440S43 NKKBH2FA, NKKBH1F1, NKKBH1B1, NKKBH2BA AT 440S45	06.03 - 06.03 - 06.03 - 06.03 - 07.06 -	F3AE0681D F3AE3681A	 4300.90.178  4303.20.00  4334.30.00  8919.40.00	430 10 MFZ430 430GTZ KZISZ - 5	- GBox: ZF16S-1920TD























Trakker 09.04 -

Trakker Euro 6			 4300.90.68  4303.20.00  4331.30.00  8939.40.00	430 10 MFZ430 430WGTZ KZISZ - 5	- Engine code: Cursor 9 - GBox: 16 S 1620 TD, 12 AS 1420 TD - GBox: 12 AS 1930 TD, 12 AS 2330 TO - Use release fork with rollers
			 4300.90.109  4390.20.00  4390.30.00  8939.40.00	4300 10 MFZ430 430WGTZ KZISZ - 5	- Engine code: Cursor 11 - Engine code: Cursor 13 - Equipment Var: 420 PS; 460 PS; 480 PS; 450 PS; 480 PS; 500 PS; - GBox: 16 S 1920 TD, 16 S 2220 TO, 12 AS 1930 TD - GBox: 12 AS 2330 TD, 12 AS 2330 TO - Use release fork with rollers
AD 180T27 W, AT 180T27 W KFKA12D2, KFKA13D2, KFKA13DB, KFKA14D2, KFKA14DB, KFKA12DB AD 190T27, AT 190T27	06.05 - 06.05 -	F2BE0681F	 4005.30.00	400 10 400GVZ	- Engine code: F2BE0681 - GBox: 9S109
			 8919.40.00	KZISZ - 5	- Engine code: F2BE0681 - GBox: 9S109
AD 190T31 W, AT 190T31 W AD 190T31 W, AT 190T31 W KUAA13BC, KUAA15B3, KUAA14BC, KUAA14B3, KUAA15BC, KUAA13B3 AD 190T31, AT 190T31 AD 260T31 B AD 260T31, AT 260T31, Dump Truck, 6x4 AD 260T31, AT 260T31, Platform/Chassis, 6x4	10.04 - 06.05 - 10.04 - 06.05 - 10.04 - 10.04 -	F2BE0681B F2BE3681C	 4007.30.00	400 10 400WGTZ	- Engine code: F2BE0681 - GBox: 12AS2301DD
			 8919.40.00	KZISZ - 5	- Engine code: F2BE0681 - GBox: 12AS2301DD - GBox: 9S109
			 4005.30.00	400 10 400GVZ	- Engine code: F2BE0681 - GBox: 9S109 - GBox: 16S109

Vehicle list

					
---	---	---	--	---	---

IVECO

Trakker		09.04 -			
AD 190T31 W, AT 190T31 W UMAA34A6, UMAB33A3, UMAB33A6, UMAB34A3, UMAB35A6, UMAB35A3, UMAA35A6, UMAA33A3, UMAA33A6, UMAA34A3	01.13 -	F2CFE611C F2CFE611D	 4300.90.68  4303.20.00  4331.30.00  8939.40.00	430 10 MFZ430 430WGTZ KZISZ - 5	- Engine code: Cursor 9 - GBox: 16 S 1620 TD, 12 AS 1420 TD - GBox: 12 AS 1930 TD, 12 AS 2330 TO - Use release fork with rollers
AD 190T33 W, AT 190T33 W UMBA33B3, UMBA34B3, UMBA35B6, UMBA35C6, UMBA33A6, UMBA34C6, UMBA34A6, UMBA35A3, UMBA34B6, UMBA35A3	01.13 -		 4339.30.00	430 10 430WGTZ	- Engine code: Cursor 9 - GBox: 9 S 1310TO
AD 190T33, AT 190T33 UABA13B1, UABA14A4, UABA15B1, UABA16B1, UABA14B4, UABA16B4, UABA17A1, UABA17B1, UABA13A1, UABA15A1	01.13 -				
AD 260T33, AT 260T33 UCBA12C4, UCBA14B1, UCBA17B1, UCBA12A1, UCBA12B4, UCBA12C1, UCBA13B1, UCBA14A1, UCBA11A4, UCBA13A1	01.13 -				
AD 190T33 W, AT 190T33 W AD 190T33, AT 190T33 AD 260T33 B KNBD71C1, KNBD73CA, KNBD72BA, KNBD71CA, KNBD72B1, KNBD73C1, KNBD71B1, KNBD71BA, KNBD72C1, KNBD73BA, KNBD72CA	03.06 - 03.06 - 07.07 -	F2BE3681A F2BE3681B	 4300.90.68  4303.20.00  4331.30.00  8939.40.00	430 10 MFZ430 430WGTZ KZISZ - 5	- Engine code: F2BE3681 - Engine code: F4AE3681 - GBox: 12AS1420TD - GBox: FS-8309A(B) - GBox: 12AS1930TD - Use release fork with rollers
AD 260T33, AD 380T33, AT 260T33, AT 380T33 AD 260T36 B AD 260T36 W, AD 380T36 W, AT 260T36 W, AT 380T36 W AD 260T36, AT 260T36 KNCA13AA, KNCA15CA, KNCA13CA, KNCA14A1, KNCA14AA, KNCA14C1, KNCA15AA, KNCA13C1, KNCA14CA, KNCA11AA	03.06 - 07.07 - 10.04 - 03.06 -		 4300.90.94  4303.20.00  4331.30.00  8919.40.00	430 10 MFZ430 430WGTZ KZISZ - 5	- Engine code: F2BE3681 - GBox: 12AS1930TD - GBox: 16S1620TD - GBox: 12AS1420TD - Use release fork with cam
AD 190T35 W, AD 190T36 W, AT 190T35 W, AT 190T36 W KFRA13A2, KFRA12A2, KUCA15A3, KUCA15AC, KUCA15CC, KFRA14A2, KUCA13A3 AD 190T35 W, AT 190T35 W, AD 190T36 W, AT 190T36 W KFRA13A2, KFRA12A2, KUCA15A3, KUCA15AC, KUCA15CC, KFRA14A2, KUCA13A3 AD 190T35, AD 190T36, AT 190T35, AT 190T36 AD 190T35, AT 190T35, AD 190T36, AT 190T36	10.04 - 01.05 - 10.04 - 06.05 -	F2BE0681A F2BE3681A	 4007.30.00  8919.40.00  4300.90.68  4303.20.00  4331.30.00  8939.40.00  4300.90.94  4303.20.00  4331.30.00  8919.40.00	400 10 400WGTZ KZISZ - 5 430 10 MFZ430 430WGTZ KZISZ - 5 430 10 MFZ430 430WGTZ KZISZ - 5	- Engine code: F2BE0681 - GBox: 12AS2301DD - Engine code: F2BE0681 - GBox: 12AS2301DD - GBox: 16S151 - Engine code: F2BE3681 - GBox: 12AS1930TD - Use release fork with rollers - Engine code: F2BE3681 - GBox: 12AS1930TD - Use release fork with cam

Vehicle list



IVECO

Trakker 09.04 -

AD 190T36 W, AT 190T36 W UMCA34B6, UMCB34B6, UMCA35C3, UMCB33B6, UMCA33B6, UMCA35B3, UMCB34C6, UMCB35B3, UMCB34C3, UMCA33C6	01.13 -	F2BE3681A F2CFE611B	4300.90.68 4303.20.00 4331.30.00 8939.40.00	430 10 MFZ430 430WGTZ KZISZ - 5	- Engine code: Cursor 9 - Engine code: F2BE3681 - GBox: 16 S 1620 TD, 12 AS 1420 TD - GBox: 12 AS 1930 TD, 12 AS 2330 TO - GBox: 12AS1930TD - Use release fork with rollers
AD 190T36, AT 190T36 UACA16B1, UACA16C4, UACA17C1, UACA15B1, UACA15B4, UACA15C4, UACA17B4, UACA13B1, UACA14B1, UACA14C1	01.13 -				
AD 260T36, AT 260T36	01.13 -				
AD 340T36, AT 340T36	03.06 - 07.07 -				
AD 340T36, AT 340T36 UGCA13C1, UGCA11B4, UGCA13B4, UGCA11B1, UGCA12C4, UGCA12B4, UGCA11C1, UGCA13B1, UGCA13C4, UGCA14B4	01.13 -				
AD 400T36 T, AT 400T36 T UBCA22B4, UBCA22B1, UBCA22C1, UBCA22C4, UBCA21B1, UBCA21C1	01.13 -				
AD 410T36, AT 410T36 KTCC12C1, KTCC12CA, KTCC13CA, KTCC12A1, KTCC14C1, KTCC14CA, KTCC11A1, KTCC11C1, KTCC12AA, KTCC13AA	03.06 -				
AD 190T38 W, AT 190T38 W	10.04 - 06.05 -	F3B3681G F3BE0681C	4300.90.04 4301.20.00 4326.30.00 8919.40.00	430 10 MFZ430 430WGTZ KZISZ - 5	- Engine code: F3BE0681 - GBox: 12AS2301OD - GBox: 16S151OD - Use release fork with cam
AD 190T38, AT 190T38, Dump Truck, 4x2	10.04 -	F3BE0681G F3BE3681C	4300.90.176 4301.20.00 4326.30.00 8939.40.00	430 10 MFZ430 430WGTZ KZISZ - 5	- Engine code: F3BE0681 - GBox: 12AS2301OD - GBox: 16S151OD - Use release fork with rollers
AD 190T38, AT 190T38, Platform/Chassis, 4x2	10.04 -				
AD 190T44 W, AD 190T45 W, AT 190T44 W, AD 190T45W	06.05 -				
AD 190T44 W, AT 190T44 W, AD 190T45W, AT 190T45W	10.04 -				
AD 190T44, AD 190T45, AT 190T44, AT 190T45	06.05 -				
AD 190T44, AT 190T44, AD 19T45, AT 190T45	10.04 -				
	06.05 -				
			4300.90.109 4390.20.00 4390.30.00 8939.40.00	4300 10 MFZ430 430WGTZ KZISZ - 5	- Engine code: F3BE3681 - GBox: 12AS2330TO - Use release fork with rollers
			4300.90.110 4390.20.00 4390.30.00 8919.40.00	430 10 MFZ430 430WGTZ KZISZ - 5	- Engine code: F3BE3681 - GBox: 12AS2330TO - GBox: 16S2220TO

Vehicle list









IVECO















Trakker 09.04 -

AD 190T41 W, AT 190T41 W UMEA35C3, UMEA34C6, UMEA35C6, UMEA35D6, UMEA34B6, UMEA34C3, UMEA33B3, UMEA33B6, UMEA33D6, UMEA34D6	03.06 -	F3B3681C F3B3681D F3BE3681B F3BE3681C		4300.90.109 4390.20.00 4390.30.00 8939.40.00	4300 10 MFZ430 430WGTZ KZISZ - 5	- Engine code: F3BE3681 - GBox: 12AS2330TO - GBox: 16S2220TO - Use release fork with rollers
AD 190T41, AT 190T41 UAEA14B4, UAEA17B4, UAEA14B1, UAEA15B4, UAEA13B1, UAEA15B1, UAEA17B1, UAEA16B4, UAEA16B1	03.06 -	F3BE3681D F3HFE611B F3HFE611C F3HFE611D		4300.90.110 4390.20.00 4390.30.00 8919.40.00	430 10 MFZ430 430WGTZ KZISZ - 5	- Engine code: F3BE3681 - GBox: 12AS2330TO - GBox: 16S2220TO - GBox: 16S2520TO
AD 260T41 W, AD 380T41 W, AT 260T41 W, AT 380T41 W	03.06 -					
AD 260T41, AD 380T41, AT 260T41, AT 380T41 UCEB12C1, UCEB13B4, UCEB14B1, UCEB15D1, UCEB16C1, UCEG11B4, UCEG12C4, UCEG14C4	03.06 -					
AD 260T45 W, AD 380T45 W, AT 260T45 W, AT 380T45 W	03.06 -					
AD 260T45, AD 380T45, AT 260T45, AT 380T45 UCFB11B1, UCFB11C1, UCFB12B4, UCFB15B4, UCFB15C1, UCFB16B1, UCFB16C1, UCFB17B1	03.06 -					
AD 260T50, AD 380T50, AT 260T50, AT 380T50 UCGB11D4, UCGB15C1, UCGB15D1, UCGG12D1, UCGG13D4, UCGG16B4, UCGB15B1, UCGB16B1	03.06 -					
AD 340T41 B	06.06 -					
AD 340T41, AT 340T41 UGEB11B1, UGEB11C4, UGEB12C4, UGEB13B4, UGEG13B1, UGEB12B1, UGEG12C4, UGEG12D4, UGEG13D1, UGEG13D4	06.06 -					
AD 340T41, AT 340T41	03.06 -					
AD 340T45 B	06.06 -					
AD 340T45, AD 340T45 /P, AT 340T45, AT 34T45 /P UGFB11C4, UGFB12C1, UGFG14B1, UGFB12B1, UGFB12D1, UGFB14C1, UGFG12C4, UGFG13B1	06.06 -					
AD 340T45, AT 340T45	03.06 -					
AD 400T41 T, AT 400T41 T UBEA22D4, UBEB22B1, UBEB22D4, UBEA21D1, UBEA22C4, UBEB22D1, UBEA21C1, UBEA22B1, UBEB21D1, UBEB22B4	03.06 -					
AD 400T41 WT, AT 400T41 WT	03.06 -					

Vehicle list

					
---	---	---	--	---	---

IVECO

Trakker		09.04 -			
AD 400T45 T, AT 400T45 T UBFA21B1, UBFB22B1, UBFA22B1, UBFA22C4, UBFB22B4, UBFA21D1, UBFA22D1, UBFA22D4, UBFB21B1, UBFB22D4	03.06 -	F3B3681C F3BE0681B F3BE3681B	 4300.90.109  4390.20.00  4390.30.00  8939.40.00	4300 10 MFZ430 430WGTZ KZISZ - 5	- Engine code: F3BE3681 - GBox: 12AS2330TO - GBox: 16S2220TO - Use release fork with rollers
AD 400T45 WT, AT 400T45 WT AD 410T45 W	03.06 - 03.06 -	F3BE3681C F3BE3681D	 4300.90.110	430 10 MFZ430 430WGTZ KZISZ - 5	- Engine code: F3BE3681 - GBox: 12AS2330TO - GBox: 16S2220TO - GBox: 16S2520TO
AD 410T45, AT 410T45 AD 410T45, AT 410T45 KTEC12AA, KTEC14A1, KTEC14AA, ULFC11C4, ULFC12B1, ULFC12C1, ULFC14B1, KTEC11A1, KTEC11CA, KTEC13A1	03.06 - 06.06 -	F3HFE611/500 F3HFE611B F3HFE611C	 4390.20.00  4390.30.00  8919.40.00		
AD 410T50, AT 410T50	03.06 -				
AD 440T41 T, AT 440T41 T UEEB21D1, UEEB21C4, UEEB21C1, UEEB21B1, UEEB21B4, UEEB21D4	03.06 -				
AD 440T45 T, AT 440T45 T UEFB21C1, UEFB21D4, UEFB21B4, UEFB21B1, UEFB21C4, UEFB21D1	03.06 -				
AD 440T50 T, AT 440T50 T UEGB21C4, UEGB21D4, UEGB21B1, UEGB21B4, UEGB21C1, UEGB21D1	03.06 -				
AD 720T45 T, AT 720T45 T UFFC21D4, UFFC21B1, UFFC21C1, UFFC21B4, UFFC21C4, UFFC21D1	03.06 -				
AD 720T45 WT, AT 720T45 WT URFC41D6, URFC41C6, URFC41D3, URFC41B3, URFC41B6, URFC41C3	03.06 -				
AD 720T50 T, AT 720T50 T, AT 720T50 TP HRFE21C1, UFGC21B4, UFGC21D4, UFGC21C4, HRFE21A1, UFGC21D1, UFGC21B1, UFGC21C1	03.06 -				
AD 190T45, AT 190T45 UAFA17B4, UAFA15B4, UAFA13B1, UAFA15B1, UAFA16B1, UAFA14B4, UAFA14B1, UAFA16B4, UAFA17B1	01.13 -	F3HFE611/450 F3HFE611D	 4300.90.109  4390.20.00  4390.30.00  8939.40.00	4300 10 MFZ430 430WGTZ KZISZ - 5	- Engine code: Cursor 13 - Engine code: Cursor 11 - GBox: 12 AS 2330 TD, 12 AS 2330 TO, 16 AS 2630 TO - GBox: 16 S 1920 TD, 16 S 2220 TO, 12 AS 1930 TD - Use release fork with rollers
AD 380T41, AT 380T41 UDEC13C1, UDEC14C1, UDEC15D1, UDEG11B4, UDEG13C4, UDEG13D1, UDEG14C1, UDEG14D1, UDEG15C1, UDEG15D1	01.13 -				
AD 380T45 W, AT 380T45 W UQFC32C3, UQFC33C6, UQFC33D6, UQFC32C6, UQFC32D6, UQFC32B3, UQFC33C3, UQFC33D3, UQFC32D3, UQFC32B6	01.13 -				
AD 260T35 B	06.05 -	F2BE0681A	 4007.30.00	400 10 400WGTZ	- Engine code: F2BE0681 - GBox: 12AS2301DD - GBox: 16S151
AD 260T35 W, AT 260T35 W KHRA14F2, KHRA13A2, KHRA14A2, KHRA13F2	06.05 -				
AD 260T35, AT 260T35 KCRA14F1, KCRA14A1, KCRA15AA, KCRA12A1, KCRA13A1, KCRA15FA, KCRA17AA, KCRA16A1, KCRA18A1, KCRA12AA	10.04 -		 8919.40.00	KZISZ - 5	- Engine code: F2BE0681 - GBox: 12AS2301DD - GBox: 16S151
AD 340T35 B, AT 340T35 B KERA71A1, KERA72A1, KERA73A1	06.05 -				
AD 400T35 T, AT 400T35 T	06.05 -				

Vehicle list









IVECO





























Trakker 09.04 -

AD 260T38 , AT 260T38 KCLE13E1, KCLE17E1, KCLE12B1, KCLE16E1, KCLE18E1, KCLE13B1, KCLE15B1, KCLE15E1, KCLE17B1, KCLE18B1	10.04 -	F3BE0681C F3BE0681E F3BE0681G		4300.90.04 4301.20.00 4326.30.00 8919.40.00	430 10 MFZ430 430WGTZ KZISZ - 5	- Engine code: F3BE0681 - GBox: 12AS2301OD - GBox: 16S151OD - GBox: 16S221OD - GBox: 16S181OD - Use release fork with cam
AD 260T38 B	06.05 -					
AD 260T38 W, AT 260T38 W KHLA13B2, KHLA13E2, KHLA14E2, KHLA14B2	06.05 -					
AD 260T38, AD 260T38 /P, AT 260T38 KCLE13E1, KCLE17E1, KCLE12B1, KHLA13B2, KHLA13E2, KCLE16E1, KCLE18E1, KCLE13B1, KCLE15B1	06.05 -			4300.90.176 4301.20.00 4326.30.00 8939.40.00	430 10 MFZ430 430WGTZ KZISZ - 5	- Engine code: F3BE0681 - GBox: 12AS2301OD - GBox: 16S151OD - GBox: 16S221OD - GBox: 16S181OD - Use release fork with rollers
AD 260T44 W, AT 260T44 W KHMA13B2, KHMA13E2, KHMA14B2, KHMA14E2	06.05 -					
AD 260T44, AD 260T44 /P, AT 260T44 KCME15E1, KCME17E1, KCME12B1, KCME13E1, KCME12E1, KCME14B1, KCME14E1, KCME13B1, KCME15B1	06.05 -					
AD 260T48, AT 260T48	06.05 -					
AD 340T38 B, AT 34T38 B KELA71B1, KELA73B1, KELA72B1	06.05 -					
AD 340T44 B, AT 340T44 B	06.05 -					
AD 380T38 B	06.05 -					
AD 380T38, AT 380T38 KCLD13E1, KELD12B1, KELD12E1, KCLD14B1, KELD13B1, KCLD12E1, KCLD13B1, KELD11B1, KELD14B1, KELD14E1	01.05 -					
AD 380T44 B	06.05 -					
AD 380T44 W, AT 380T44 W	06.05 -					
AD 380T44, AT 380T44 KCMD15E1, KCMD13E1, KCMD14B1, KCMD12E1, KCMD13B1, KCMD12B1, KCMD14E1, KCMD15B1	06.05 -					
AD 380T48, AD 380T48 KCSD13E1, KCSD14EA, KCSD12B1, KCSD14E1, KCSD15B1, KCSD13B1, KCSD15E1, KCSD14B1, KCSD12E1	06.05 -					
AD 400T38 T, AT 400T38 T KOUAH2B1, KOUAH1B1, KOUAH1B1, KOUAH2B1	06.05 -					
AD 400T38 WT, AT 400T38 WT	06.05 -					
AD 400T44 T, AT 400T44 T KBMA22B1, HBMA22E2, H0VAH22B2, KBMA22E1, KBMA21B1, KBMA21E1, HBMA22B2	06.05 -					
AD 400T44 WT, AT 400T44 WT	06.05 -					
AD 410T38 B, AT 410T38 B KELD71B1, KELD72B1, KELD73B1	06.05 -					
AD 410T44 B, AT 410T44 B	06.05 -					

Vehicle list

					
---	---	---	--	---	---

IVECO

Trakker		09.04 -				
AD 410T48 B, AT 410T48 B	06.05 -	F3BE0681C		4300.90.04	430 10	- Engine code: F3BE0681
AD 410T48, AT 410T48 HESD13E1, KESD11E1, KESD12B1, HESD13B1, HESD11E1, HESD12B1, KESD13E1, KESD14B1, HESD12E1, HESD14B1	02.05 -	F3BE0681E F3BE0681G	  	4301.20.00 4326.30.00 8919.40.00	MFZ430 430WGTZ KZISZ - 5	- GBox: 12AS2301OD - GBox: 16S151OD - GBox: 16S221OD - GBox: 16S181OD - Use release fork with cam
AD 440T38 T, AT 440T38 T KDLA22BA, KDLA22B1, KDLA22E1, KDLA22EA	04.05 -			4300.90.176	430 10	- Engine code: F3BE0681
AD 440T44 B	06.05 -		  	4301.20.00 4326.30.00 8939.40.00	MFZ430 430WGTZ KZISZ - 5	- GBox: 12AS2301OD - GBox: 16S151OD - GBox: 16S221OD - GBox: 16S181OD - Use release fork with rollers
AD 440T44 T, AT 440T44T HDME22B1, HDME22E1	06.05 -					
AD 720T38 T, AT 720T38 T	06.05 -					
AD 720T38 WT, AT 720T38 WT	06.05 -					
AD 720T44 T, AT 720T44 T	06.05 -					
KDMD22BA, KDMD22B1, KDMD22E1, KDMD22EA	06.05 -					
AD 720T44 WT, AT 720T44 WT	06.05 -					
HJMD23E2, HJMD23B2	06.05 -					
AD 720T48 T, AT 720T48 T KDSD22E1, KDSD22B1	06.05 -					
AD 400T36 T, AT 400T36 T	10.04 -	F2BE3681A		4300.90.94	430 10	- Engine code: F2BE3681
			  	4303.20.00 4331.30.00 8919.40.00	MFZ430 430WGTZ KZISZ - 5	- GBox: 16S1620TD - Use release fork with cam
AD 400T50 T, AT 400T50 T	03.06 -	F3BE3681B F3HFE611B		4300.90.110	430 10	- Engine code: F3BE3681
UBGB21D1, UBGA22B1, UBGA22D1, UBGA22D4, UBGB22D1, UBGB21B1, UBGA21B1, UBGA21C1, UBGA21D1, UBGB22C1			  	4390.20.00 4390.30.00 8919.40.00	MFZ430 430WGTZ KZISZ - 5	- GBox: 12AS2330TO
TurboStar		07.84 - 12.93				
190-33	07.84 - 09.86	8210.22.105		4300.90.36 ⊕	430 10	- To chassis no.: 140027
190-33	10.86 - 05.87		 	4334.60.00 4327.30.00	MFZ430 430GTZ	- GBox: Fuller - To chassis no.: 140027
190-33 P 43052371, 43072264, 43072371, 43051351, 43052271, 43052351, 43051131, 43051151, 43051251, 43071331, 43072351, 43052264	01.86 - 12.87			4309.26.00 ⊖	430	- To chassis no.: 140027
190-33 T	07.84 - 09.86				MFZ430	- GBox: Fuller - From chassis no.: 140028 - GBox: ZF - GBox: Fuller - Contained in xxxx.60.00
	10.86 - 05.87			8930.40.00	KZI/Z-5	- From model year: 09.1984 - To chassis no.: 140027 - GBox: Fuller - Contained in xxxx.60.00
			  	4300.90.37 ⊕ 4310.60.00 4327.30.00	430 10	- From chassis no.: 140028 - GBox: Fuller - From chassis no.: 140028
			  	4300.90.06 ⊕ 4310.60.00 4326.30.00	430 10	- From chassis no.: 140028 - GBox: ZF
				8924.46.00	KZIZ5	- GBox: ZF - GBox: Fuller - Contained in xxxx.60.00 - From chassis no.: 140028

Vehicle list



IVECO

TurboStar 07.84 - 12.93

190-36 43052371, 43072264, 43072371, 43051351, 43052271, 43052351, 43051131, 43051151, 43051251, 43071331, 43072351, 43052264 190-36 P 43052371, 43072264, 43072371, 43051351, 43052271, 43052351, 43051131, 43051151, 43051251, 43071331, 43072351, 43052264 190-36 T 43052371, 43072264, 43072371, 43051351, 43052271, 43052351, 43051131, 43051151, 43051251, 43071331, 43072351, 43052264	07.87 - 06.90	8210.42.101		4300.90.37 ⊕ 4310.60.00 4327.30.00	430 10 MFZ430 430GTZ	- GBox: Fuller
	07.90 - 12.93	8210.42.152		4300.90.06 ⊕ 4310.60.00 4326.30.00	430 10 MFZ430 430WGTZ	- GBox: ZF
	07.87 - 06.90	8210.42.162		4309.26.00 ⊖	430 MFZ430	- GBox: ZF - GBox: Fuller - Contained in xxxx.60.00
	07.90 - 12.93	8210.42.181		8924.46.00	KZIZ5	- GBox: ZF - GBox: Fuller - Contained in xxxx.60.00
190-42 190-42 41011211, 41032211, 41011111, 41012204, 41012211, 41011311, 41031311, 41012311, 41032311 190-42 T 41011211, 41032211, 41011111, 41012204, 41012211, 41011311, 41031311, 41012311, 41032311	07.84 - 09.86	8280.22.201		4300.90.36 ⊕ 4334.60.00 4327.30.00	430 10 MFZ430 430GTZ	- To chassis no.: 140027 - GBox: Fuller
	10.86 - 12.90	8280.22.205		4309.26.00 ⊖	430 MFZ430	- GBox: Fuller - Contained in xxxx.60.00 - From model year: 19.1984 - GBox: ZF
	07.84 - 09.86			8930.40.00	KZI/Z-5	- To chassis no.: 140027 - GBox: Fuller - Contained in xxxx.60.00
	10.86 - 12.90			4300.90.37 ⊕ 4310.60.00 4327.30.00	430 10 MFZ430 430GTZ	- From chassis no.: 140028 - GBox: Fuller
				8924.46.00	KZIZ5	- From chassis no.: 140028 - GBox: Fuller - Contained in xxxx.60.00 - From model year: 09.1984 - GBox: ZF
				4300.90.06 ⊕ 4310.60.00 4326.30.00	430 10 MFZ430 430WGTZ	- From model year: 09.1984 - GBox: ZF
190-48 41051111, 41051211, 41052204, 41052231, 41052311, 41072231, 41051231, 41071331, 41051131, 41052211, 41052224, 41072211 190-48 T 41051111, 41051211, 41052204, 41052231, 41052311, 41072231, 41051231, 41071331, 41051131, 41052211, 41052224, 41072211	03.89 - 03.91	8280.42.001		4300.90.02 4301.20.00 4327.30.00 8919.40.00	430 10 MFZ430 430GTZ KZISZ - 5	- GBox: Fuller
	04.91 - 12.93	8280.42.050		4300.90.04 4301.20.00 4326.30.00 8919.40.00	430 10 MFZ430 430WGTZ KZISZ - 5	- GBox: ZF
	03.89 - 03.91					
	04.91 - 12.93					

Vehicle list



IVECO

TurboTech 01.90 - 01.93

190-26 41111331, 41112131, 41112251, 41111151, 41111251, 41111531, 41111631, 41112231, 41111131, 41112151, 41111351, 41111231 190-26 T 41111331, 41112131, 41112251, 41111151, 41111251, 41111531, 41111631, 41112231, 41111131, 41112151, 41111351, 41111231 190-32 41132231, 41152331, 41131431, 41131451, 41171331, 41131231, 41131251, 41131331, 41131351, 41152231, 41172231, 41132351 190-32 T 41132231, 41152331, 41131431, 41131451, 41171331, 41131231, 41131251, 41131331, 41131351, 41152231, 41172231, 41132351	01.90 - 12.92	8460.21.102 8460.41.102		4236.20.00	420 GF420KR	- To chassis no.: 93115 - GBox: Fuller, ZF	
					4268.30.00	420 10 420GSZ	- To chassis no.: 93115 - GBox: Fuller, ZF
		01.90 - 12.92			8510.40.00	KZI - 4,5	- To chassis no.: 93115 - GBox: Fuller, ZF
					4278.20.00	420 GFX420KR	- From chassis no.: 93116 - GBox: Fuller, ZF
		01.90 - 12.92			4250.30.00	420 10 420WGSZ	- From chassis no.: 93116 - GBox: Fuller, ZF
190-36 43032251, 43011171, 43011351, 43011271, 43012271, 43012351, 43031351, 43011371, 43011471, 43031744, 43012371, 43032244 190-36 T 43032251, 43011171, 43011351, 43011271, 43012271, 43012351, 43031351, 43011371, 43011471, 43031744, 43012371, 43032244	01.90 - 12.92	8210.42.151 8210.42.161 8210.42.171		4300.90.37 ⊕ 4310.60.00 4327.30.00	430 10 MFZ430 430GTZ	- GBox: Fuller	
		01.90 - 12.92			4300.90.06 ⊕ 4310.60.00 4326.30.00	- GBox: ZF	
					4309.26.00 ☾	430 MFZ430	- GBox: Fuller, ZF - Contained in xxxx.60.00
					8924.46.00	KZIZ5	- GBox: Fuller, ZF - Contained in xxxx.60.00
220-36 PT 42132171, 42132144, 42132151, 42132164 240-36 P 42431351, 43511211, 42431171, 42231171, 42431151, 42231251, 42231271, 42231151	01.90 - 12.92	8210.42.152 8210.42.155		4300.90.37 ⊕ 4310.60.00 4327.30.00	430 10 MFZ430 430GTZ	- GBox: Fuller	
	01.90 - 12.92	8210.42.165 8210.42.172 8210.42.175		4309.26.00 ☾	430 MFZ430	- GBox: Fuller - Contained in xxxx.60.00	
		8210.42.185 8210.42.186 8210.42.195		8924.46.00	KZIZ5	- GBox: Fuller - Contained in xxxx.60.00	

Zeta 01.79 - 12.92

50-10 50-10 H 50-10 V 50-8 50-8 H 50-8 V 50-9 11011111, 11011211, 11016211, 11016311, 11011311 50-9 H 11011111, 11011211, 11016211, 11016311, 11011311 50-9 V 11014211, 11014311 60-11 11076311, 11071111, 11071211, 11071311, 11076211 60-11 V 11074311, 11074211 79-13, Van/Estate 79-13, Dump Truck 79-13, Platform/Chassis	01.79 - 12.86	8040.04.200		3100.90.13	310 10	
	01.79 - 12.86	8040.05.230		3169.20.00	MF310	
	01.79 - 12.86	8040.25.230 R		3113.30.00 7903.40.00	310GSBL KZI-4	
	01.83 - 12.86	8060.04.060 8060.04.660		2654.20.00	270 MF270	
	01.83 - 12.86	8340.04.200 8340.04.250		2656.30.00	270 10 270CTB	
	01.87 - 03.91	8340.04.300 8340.04.362				
	01.87 - 03.91					
	01.87 - 03.91					
	11.79 - 12.83					
	11.79 - 12.83					
	11.79 - 12.83					
60-8	11.79 - 12.82	8040.04.200		2514.20.00	250 H250K	
	11.79 - 12.81			2514.30.00	250 10 250CBL	
	11.79 - 12.83					

Vehicle list



IVECO

Zeta 01.79 - 12.92

60-10	11.79 - 12.86	8340.04.200		2809.20.00	280 H280	- To model year: 08.1983
60-10 H	11.79 - 12.86	8340.04.250		2810.20.00	280 H280K	- From model year: 09.1983
60-10 V	11.79 - 12.86			2810.30.00	280 10 280CBL	
				5800.40.00	KZA - 2	- To model year: 02.1982
65-10	11.79 - 01.87	8340.04.200		2809.20.00	280 H280	
65-10 H	11.79 - 01.87	8340.04.250		2810.30.00	280 10 280CBL	
65-10 V	11.79 - 01.87	8340.04.300 8340.04.350				
65-12 11051331, 11056211, 11056311, 11051304, 11051431, 11051211, 11051311, 11051411, 11056331, 11051231, 11051204, 11056231	01.87 - 03.91	8040.25.200 8040.25.220		3100.90.13 3169.20.00 3113.30.00 7903.40.00	310 10 MF310 310GSBL KZI-4	
65-12 H 11051331, 11056211, 11056311, 11051304, 11051431, 11051211, 11051311, 11051411, 11056331, 11051231, 11051204, 11056231	01.87 - 03.91					
65-12 V 11054231, 11054311, 11054304, 11054324, 11054211, 11054331	01.87 - 03.91					
79-12 11111111, 11131111, 11131211, 11116211, 11111311, 11111211, 11131311, 11136211, 7.49t	01.87 - 03.91					
79-12 11111111, 11131111, 11131211, 11116211, 11111311, 11111211, 11131311, 11136211, 8.10t	01.87 - 03.91					
79-12 H 11111111, 11131111, 11131211, 11116211, 11111311, 11111211, 11131311, 11136211, 7.49t	01.87 - 03.91					
79-12 H 11111111, 11131111, 11131211, 11116211, 11111311, 11111211, 11131311, 11136211, 8.10t	01.87 - 03.91					
79-12 V 11114204, 11134211, 11134204, 11114211, 8.10t	01.87 - 03.91					
79-12 V 11114204, 11134211, 11134204, 11114211, 7.49t	01.87 - 03.91					
79-10, 8.00t	01.83 - 01.87	8340.04.200		2809.20.00	280 H280	- To model year: 08.1983
79-10, 7.49t	01.83 - 01.87	8340.04.300		2810.20.00	280 H280K	- From model year: 09.1983
79-10 H, 8.00t	01.83 - 01.87			2810.30.00	280 10 280CBL	
79-10 H, 7.49t	01.83 - 01.87					
79-10 V, 8.00t	01.83 - 01.87					
79-10 V, 7.49t	01.83 - 01.87			5800.40.00	KZA - 2	- From model year: 09.1983



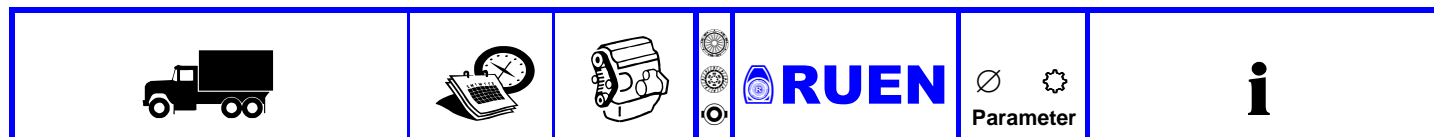



Vehicle list





























IVECO

Zeta		01.79 - 12.92				
79-14 31910231, 31910251, 31911131, 31911244, 31911331, 31916251, 31910244, 31911151, 31911251, 31916231, 31910224, 31911324, 7.49t	01.83 - 11.85	8060.04.660		3100.90.13 3169.20.00 3113.30.00 7903.40.00	310 10 MF310 310GSBL KZI-4	- From model year: 11.1984
79-14 31910231, 31910251, 31911131, 31911244, 31911331, 31916251, 31910244, 31911151, 31911251, 31916231, 31910224, 31911324, 8.10t	01.83 - 11.85					
79-14 H 31910231, 31910251, 31911131, 31911244, 31911331, 31916251, 31910244, 31911151, 31911251, 31916231, 31910224, 31911324, 7.49t	01.83 - 11.85					
79-14 H 31910231, 31910251, 31911131, 31911244, 31911331, 31916251, 31910244, 31911151, 31911251, 31916231, 31910224, 31911324, 8.10t	01.83 - 11.85					
79-14 V 31914224, 31914231, 31914251, 31914244, 8.10t	01.83 - 11.85					
79-14 V 31914224, 31914231, 31914251, 31914244, 7.49t	01.83 - 11.85					
109-14 32111331, 32111131, 32111431, 32111231	11.85 - 03.91	8060.04.669 8060.05.280		3100.90.13 3169.20.00 3113.30.00 7903.40.00	310 10 MF310 310GSBL KZI-4	
109-14 H 32111331, 32111131, 32111431, 32111231	11.85 - 03.91	8060.05.289				
79-14 31910231, 31910251, 31911131, 31911244, 31911331, 31916251, 31910244, 31911151, 31911251, 31916231, 31910224, 31911324, 7.49t	12.85 - 03.91					
79-14 31910231, 31910251, 31911131, 31911244, 31911331, 31916251, 31910244, 31911151, 31911251, 31916231, 31910224, 31911324, 8.10t	12.85 - 03.91					
79-14 H 31910231, 31910251, 31911131, 31911244, 31911331, 31916251, 31910244, 31911151, 31911251, 31916231, 31910224, 31911324, 7.49t	12.85 - 03.91					
79-14 H 31910231, 31910251, 31911131, 31911244, 31911331, 31916251, 31910244, 31911151, 31911251, 31916231, 31910224, 31911324, 8.10t	12.85 - 03.91					
79-14 V 31914224, 31914231, 31914251, 31914244, 8.10t	12.85 - 03.91					
79-14 V 31914224, 31914231, 31914251, 31914244, 7.49t	12.85 - 03.91					
95-14 32011131, 32011231, 32011331, 32011431	11.85 - 03.91					
95-14 H 32011131, 32011231, 32011331, 32011431	11.85 - 03.91					
109-14 32111331, 32111131, 32111431, 32111231	06.83 - 12.85	8060.04.669 8060.04.689		3100.90.13 3169.20.00 3113.30.00 7903.40.00	310 10 MF310 310GSBL KZI-4	- From model year: 09.1983
109-14 H 32111331, 32111131, 32111431, 32111231	06.83 - 12.85					
95-14 32011131, 32011231, 32011331, 32011431	07.83 - 10.85					
95-14 H 32011131, 32011231, 32011331, 32011431	07.83 - 10.85					
65-9 11731311, 11731215, 11731211, 11731111, 11731315	01.87 - 03.91	8040.05.200 8040.05.203		2654.20.00	270 MF270	- Engine code: 8040
A 60-9 92640011, 92630011	09.88 - 12.92	8040.05.230		2656.30.00	270 10 270CTB	- Engine code: 8040
A 70-14 92750011, 92750031, 92750024	05.88 - 12.92	8060.05.246 8060.05.285				

Vehicle list

					
---	---	---	--	---	---

IVECO

Zeta		01.79 - 12.92				
A 60-10	11.79 - 06.88	8340.04.040		2810.20.00	280 H280K	- To model year: 08/1983
A 70-12	01.83 - 01.85	8340.05.200		2810.30.00	280 10 280CBL	
				6301.40.00	KZI - 2	- From model year: 09/1983
60...						
60 U-10	- 02.82			2810.20.00	280 H280K	
65 F	- 12.78			2810.30.00	280 10 280CBL	
				5800.40.00	KZA - 2	
65 NC				2810.20.00	280 H280K	
65 NC /70 NC	01.73 - 12.78			2810.30.00	280 10 280CBL	
65 U-10	- 10.78					
65/60 U-10	- 10.78					
65-12 A Fire Fighting	01.89 -			3162.20.00	310 MF310	
				3113.30.00	310 10 310GSBL	
				6905.40.00	KZIS - 3	
70...						
70 NC				2810.20.00	280 H280K	
70 NC /70 NC (Mot. Deutz)	01.73 - 12.78			2810.30.00	280 10 280CBL	
70 NC /75 NC	01.75 - 12.78					
70 U-10						
70-10						
70-10 (Mot. Deutz)	- 12.75					
75 NC						
79 U-10	- 10.78					
70-10	01.73 - 12.75			2810.20.00	280 H280K	
75 F 10/79 F 10	01.78 -			2810.30.00	280 10 280CBL	
75 U-10	- 02.82			5800.40.00	KZA - 2	
75-10	- 02.82					
75-13 AW				3162.20.00	310 MF310	
75-13 AWM	01.87 -			3113.30.00	310 10 310GSBL	
				6905.40.00	KZIS - 3	
90...						
90 NC	01.75 -			2810.20.00	280 H280K	
				2810.30.00	280 10 280CBL	
90-13 AT				3166.20.00	310 MF310	
				3113.30.00	310 10 310GSBL	
				6909.40.00	KZI - 3	
90-16 AW				3570.20.00	350 GMF350	
				3585.30.00	350 10 350GSZ	
				6905.40.00	KZIS - 3	







Vehicle list



IVECO



110...						
110-14 P 4x4				3169.20.00	310 MF310	- GBox: ZF
				3113.30.00	310 10 310GSBL	- GBox: ZF
				8508.40.00	KZI - 4,5	- GBox: ZF
110-16 AW 110-16 AWM 110-17 AWM	01.84 - 01.84 -			3570.20.00	350 GMF350	
				3585.30.00	350 10 350GSZ	
				6905.40.00	KZIS - 3	
115-14				3100.90.13	310 10	- GBox: Fiat
				3169.20.00	MF310	
				3113.30.00	310GSBL	
				7903.40.00	KZI-4	
				3169.20.00	310 MF310	- GBox: ZF
				3113.30.00	310 10 310GSBL	- GBox: ZF
120-17 H (Version 42231628,42231929)				3570.20.00	350 GMF350	- For: Version 42231628 - For: Version 42231929
				3585.30.00	350 10 350GSZ	- For: Version 42231628 - For: Version 42231929
				6905.40.00	KZIS - 3	
120-13 AN				2955.20.00	295 GF295	
				6905.40.00	KZIS - 3	
120-25 AW (Version 42231628,42231929)	01.88 -			3895.20.00	380 G380KR	
				38115.30.00	380 10 380GSZ	
				8514.40.00	KZI - 4,5	
130...						
130-13 AN (Version 42231628,42231929)				6905.40.00	KZIS - 3	
130-16 AT (Version 42231628,42231929)				3570.20.00	350 GMF350	
				3585.30.00	350 10 350GSZ	
				6905.40.00	KZIS - 3	
135-14 ,H				3100.90.13	310 10	- GBox: Fiat
				3169.20.00	MF310	
				3113.30.00	310GSBL	
				7903.40.00	KZI-4	
				3169.20.00	310 MF310	- GBox: ZF
				3113.30.00	310 10 310GSBL	- GBox: ZF
140...						
140-19				3563.20.00	350 GMF350	
				3583.30.00	350 10 350GSZ	
				8514.40.00	KZI - 4,5	

Vehicle list













					
---	---	---	--	---	---

IVECO

















150...

150-17 2. Serie	02.78 -		 3570.20.00	350 GMF350	- GBox: ZF
			 3585.30.00	350 10 350GSZ	- GBox: ZF







160...

160-16 A	02.78 -		 3570.20.00	350 GMF350	- GBox: ZF
			 3585.30.00	350 10 350GSZ	- GBox: ZF
160-19 ANW			 3563.20.00	350 GMF350	
			 3583.30.00	350 10 350GSZ	
			 8514.40.00	KZI - 4,5	
160-26, T			 4278.20.00	420 GFX420KR	- GBox: Fiat
			 4208.30.00	420 10 420GS	- GBox: Fiat
			 8510.40.00	KZI - 4,5	- GBox: Fiat
165-24, T			 3895.20.00	380 G380KR	
			 38115.30.00	380 10 380GSZ	
			 8510.40.00	KZI - 4,5	- GBox: ZF
			 8512.40.00	KZI - 4,5	- GBox: Fuller

170...



170 NC 26			 4200.90.49	420 10 GF420KR 420GSZ KZI - 4,5	
			 4236.20.00		
			 4265.30.00		
			 8532.40.00		
170 NC 33, 35 170 NT 33 170-32 170-32 170-33 170-35			 4278.20.00	420 GFX420KR	
			 4268.30.00	420 10 420GSZ	
170-26	01.79 -		 4278.20.00	420 GFX420KR	
			 4208.30.00	420 10 420GS	
			 8512.40.00	KZI - 4,5	- GBox: ZF
170-26	- 12.78		 4200.90.49	420 10 GF420KR 420GSZ KZI - 4,5	
			 4236.20.00		
			 4265.30.00		
			 8512.40.00		
170-30	01.79 -		 4278.20.00	420 GFX420KR	- GBox: Fuller
			 4268.30.00	420 10 420GSZ	- GBox: Fuller
			 8512.40.00	KZI - 4,5	- GBox: Fuller

Vehicle list

















					
---	---	---	--	---	---

IVECO













170...

170-35 , T			 4278.20.00	420 GFX420KR	
			 4268.30.00	420 10 420GSZ	
			 8512.40.00	KZI - 4,5	

180...

180-24 , T			 3895.20.00	380 G380KR	
			 38115.30.00	380 10 380GSZ	
			 8510.40.00	KZI - 4,5	- GBox: ZF
			 8512.40.00	KZI - 4,5	- GBox: Fuller
190 NC /H 26			 4200.90.49	420 10 GF420KR	
			 4236.20.00	420GSZ	
			 4265.30.00	KZI - 4,5	
			 8532.40.00	KZI - 4,5	- GBox: ZF
180-26			 8512.40.00	KZI - 4,5	- GBox: Fuller
			 4200.90.49	420 10 GF420KR	
			 4236.20.00	420GSZ	
			 4265.30.00	KZI - 4,5	
180-26			 8532.40.00	KZI - 4,5	- GBox: Fiat
			 4278.20.00	420 GFX420KR	- GBox: Fuller
			 4208.30.00	420 10 420GS	- GBox: Fuller
			 8512.40.00	KZI - 4,5	- GBox: Fuller

190...

190 NC 26 190 NC 30 190 U 26 190-33 190-35			 4278.20.00	420 GFX420KR	
			 4268.30.00	420 10 420GSZ	
190 NT /H 26 190 PAC 190 PAC 26 190 PAT 190 U 26/T/TH 190-26	10.78 -		 4200.90.49	420 10 GF420KR	
			 4236.20.00	420GSZ	
			 4265.30.00	KZI - 4,5	
			 8532.40.00	KZI - 4,5	- GBox: Fiat
190 PAC /F 20 190 PAC /H 20 190 PAC /20	01.76 - 01.76 - 01.76 -		 8512.40.00	KZI - 4,5	- GBox: Fuller
			 3895.20.00	380 G380KR	
			 38115.30.00	380 10 380GSZ	
190 PAC 20 190-20 N			 3895.20.00	380 G380KR	- GBox: ZF
			 38115.30.00	380 10 380GSZ	- GBox: ZF
			 8514.40.00	KZI - 4,5	- GBox: ZF



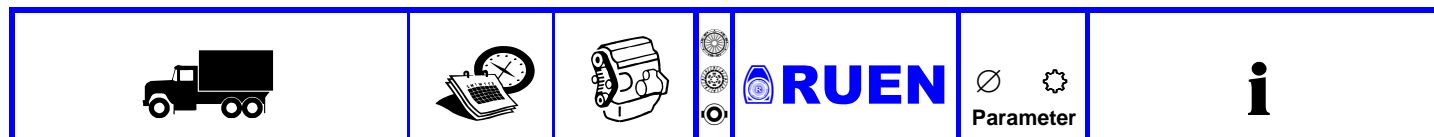



Vehicle list







































IVECO

190...						
190 PAT 26 190 PC 26 4x2, 4x4 190 PT 26 4x2 190-26 H, HT, HW 190-26 N, NT, NW				4200.90.49	420 10	- GBox: ZF
				4236.20.00	GF420KR	
				4265.30.00	420GSZ	
				8532.40.00	KZI - 4,5	
				8514.40.00	KZI - 4,5	- GBox: ZF
190 PC 190-35 H/HT				4278.20.00	420	- GBox: Fiat
				4268.30.00	420 10	- GBox: Fiat
				420GSZ		
				8514.40.00	KZI - 4,5	- GBox: Fiat
190 PC 30				4278.20.00	420	- GBox: Fuller
				420GSZ		
				8514.40.00	KZI - 4,5	- GBox: Fuller
190 U T 190-30 P, T, PT	- 09.80			4278.20.00	420	
	- 12.84			420GSZ		
				4268.30.00	420 10	
				420GSZ		
				8512.40.00	KZI - 4,5	- GBox: Fuller
190-24 190-25 A, AT	- 12.84			3895.20.00	380	- GBox: Fuller
				G380KR		
				38115.30.00	380 10	- GBox: Fuller
				380GSZ		
				8512.40.00	KZI - 4,5	- GBox: Fuller
190-26 , T	- 12.84			4278.20.00	420	- GBox: Fuller
				420GSZ		
				4265.30.00	420 10	- GBox: Fuller
				420GSZ		
				8512.40.00	KZI - 4,5	- GBox: Fuller
190-29 A,AP 190-29 AT, APT				4299.20.00	420	
				420GSZ		
				4268.30.00	420 10	
				420GSZ		
				8512.40.00	KZI - 4,5	
190-30 AHT				4299.20.00	420	
				420GSZ		
				4268.30.00	420 10	
				420GSZ		
				8514.40.00	KZI - 4,5	
190-30 P, T, PT	01.85 -			4278.20.00	420	- GBox: Ecosplit 16 S 130
				420GSZ		- GBox: Fuller
				4250.30.00	420 10	- GBox: Ecosplit 16 S 130
				420WGSZ		
				8510.40.00	KZI - 4,5	- GBox: Ecosplit 16 S 130
						- GBox: Fuller
			4268.30.00	420 10	- GBox: Fuller	
			420GSZ			
			4208.30.00	420 10	- GBox: Fuller	
			420GS			
190-32	01.87 -			4310.60.00 ⊕	430	
				MFZ430		
				4326.30.00	430 10	- Loose clutch disc
				430WGTZ		
			4309.26.00 ⊖	430	- Contained in xxxx.60.00	
			MFZ430			
			8924.46.00	KZIZ5	- Contained in xxxx.60.00	

Vehicle list

					
---	---	---	--	---	---



































IVECO

190...					
190-32 A, AT 190-32 AH, AHT, AHW			 4298.20.00	420 GF420	
			 4268.30.00	420 10 420GSZ	
			 8514.40.00	KZI - 4,5	
190-35 , T	- 12.84		 4278.20.00	420 GFX420KR	- GBox: Fuller
			 4268.30.00	420 10 420GSZ	- GBox: Fuller
			 4208.30.00	420 10 420GS	- GBox: Fuller
			 8512.40.00	KZI - 4,5	- GBox: Fuller
190-35 , T			 4278.20.00	420 GFX420KR	- GBox: Fuller
			 4268.30.00	420 10 420GSZ	- GBox: Fuller
			 8512.40.00	KZI - 4,5	- GBox: Fuller
190-36 APT	- 12.84		 4299.20.00	420 GFX420K	- GBox: Fuller
			 4268.30.00	420 10 420GSZ	- GBox: Fuller
			 8512.40.00	KZI - 4,5	- GBox: Fuller
190-38 , T, P, PT	01.87 -		 4300.90.37 ⊕	430 10 MFZ430 430GTZ	- GBox: Fuller
			 4310.60.00		
			 4327.30.00		
			 4309.26.00 ⊖	430 MFZ430	- GBox: Fuller - Contained in xxxx.60.00
190-38 Turbo Star	01.87 -		 8924.46.00	KZIZ5	- GBox: Fuller - Contained in xxxx.60.00
			 4300.90.37 ⊕	430 10 MFZ430 430GTZ	- GBox: ZF
			 4310.60.00		
			 4327.30.00		
 4309.26.00 ⊖	430 MFZ430	- GBox: ZF - Contained in xxxx.60.00			
190-38 Turbo Star	01.87 -		 8924.46.00	KZIZ5	- GBox: ZF - Contained in xxxx.60.00
			 4300.90.04	430 10 MFZ430 430WGTZ KZISZ - 5	
			 4301.20.00		
			 4326.30.00		
 8919.40.00					
190-33	09.84 -		 4327.30.00	430 10 430GTZ	- To chassis no.: 140027 - GBox: ZF
200...					
200-32			 4278.20.00	420 GFX420KR	
			 4268.30.00	420 10 420GSZ	
200-32 AHW, AHWM			 4235.20.00	420 GF420KR	- GBox: ZF
			 4237.30.00	420 10 420GSZ	- GBox: ZF
			 8514.40.00	KZI - 4,5	- GBox: ZF
220...					
220-29 AP			 4299.20.00	420 GFX420K	- GBox: Fuller
			 4268.30.00	420 10 420GSZ	- GBox: Fuller
			 8512.40.00	KZI - 4,5	- GBox: Fuller







Vehicle list

					
---	---	---	--	---	---



































IVECO

220...					
220-30 PT	01.85 -		 4278.20.00	420 GFX420KR	- GBox: Fuller
			 4268.30.00	420 10 420GSZ	- GBox: Fuller
			 4208.30.00	420 10 420GS	- GBox: Fuller
			 8510.40.00	KZI - 4,5	- GBox: Fuller
220-32 AHW, AHTM			 4235.20.00	420 GF420KR	- GBox: ZF
			 4237.30.00	420 10 420GSZ	- GBox: ZF
			 8514.40.00	KZI - 4,5	- GBox: ZF
220-35 T			 4278.20.00	420 GFX420KR	- GBox: Fuller
			 4268.30.00	420 10 420GSZ	- GBox: Fuller
			 4208.30.00	420 10 420GS	- GBox: Fuller
			 8510.40.00	KZI - 4,5	- GBox: Fuller
220-36 AP, APT 220-38 PT	- 12.84 - 12.84		 4310.60.00 ⊕	430 MFZ430	- GBox: Fuller
			 4309.26.00 ⊖	430 MFZ430	- GBox: Fuller - Contained in xxxx.60.00
			 8924.46.00	KZIZ5	- GBox: Fuller - Contained in xxxx.60.00
220-38 PT			 4300.90.37 ⊕	430 10 MFZ430 430GTZ	- GBox: Fuller
			 4310.60.00		
			 4327.30.00		
			 4309.26.00 ⊖	430 MFZ430	- GBox: Fuller - GBox: ZF - Contained in xxxx.60.00
			 4300.90.36 ⊕	430 10 MFZ430 430GTZ	- GBox: Fuller
			 4334.60.00		
			 4327.30.00		
			 8930.40.00	KZI/Z-5	- GBox: Fuller - Contained in xxxx.60.00
 4300.90.06 ⊕	430 10 MFZ430 430WGTZ	- GBox: ZF			
 4310.60.00					
 4326.30.00					
 8924.46.00	KZIZ5	- GBox: Fuller - GBox: ZF - Contained in xxxx.60.00			
229...					
229			 2514.30.00	250 10 250CBL	
230...					
230-26			 4200.90.49	420 10 GF420KR 420GSZ KZI - 4,5	
			 4236.20.00		
			 4265.30.00		
			 8532.40.00		
 8532.40.00	KZI - 4,5	- GBox: ZF			
 8512.40.00	KZI - 4,5	- GBox: Fuller			
230-32			 4278.20.00	420 GFX420KR	
			 4268.30.00	420 10 420GSZ	

Vehicle list

					
---	---	---	--	---	---

IVECO

240...					
240-26			 4278.20.00	420 GFX420KR	
			 4208.30.00	420 10 420GS	
			 8512.40.00	KZI - 4,5	- GBox: Fiat
240-30	01.85 -		 4278.20.00	420 GFX420KR	- GBox: Fuller
			 4268.30.00	420 10 420GSZ	- GBox: Fuller
			 4208.30.00	420 10 420GS	- GBox: Fuller
			 4250.30.00	420 10 420WGSZ	- GBox: ZF16 S130
			 8510.40.00	KZI - 4,5	- GBox: Fuller - GBox: ZF16 S130
240-30 P	- 12.84		 4278.20.00	420 GFX420KR	- GBox: Fuller
			 4268.30.00	420 10 420GSZ	- GBox: Fuller
			 8512.40.00	KZI - 4,5	- GBox: Fuller
240-36 Turbo Star 240-48 Turbo Star	01.89 - 01.89 -		 4300.90.04	430 10 MFZ430	- GBox: ZF
			 4301.20.00	430WGTZ	
			 4326.30.00	KZISZ - 5	
	 4300.90.02	430 10 MFZ430	- GBox: Fuller		
	 4301.20.00	430GTZ			
	 4327.30.00	KZISZ - 5			
240-38	01.85 -		 4326.30.00	430 10 430WGTZ	- GBox: ZF
			 4300.90.37 ⊕	430 10 MFZ430	- GBox: Fuller
			 4310.60.00	430GTZ	
			 4327.30.00		
			 8924.46.00	KZIZ5	- GBox: Fuller - GBox: ZF - Contained in xxxx.60.00
			 4300.90.36 ⊕	430 10 MFZ430	- GBox: Fuller
			 4334.60.00	430GTZ	
			 4327.30.00		
			 8930.40.00	KZIZ-5	- GBox: Fuller - Contained in xxxx.60.00
			 4300.90.06 ⊕	430 10 MFZ430	- GBox: ZF
 4310.60.00	430WGTZ				
 4326.30.00					
240-38 P	- 12.84		 4309.26.00 ⊖	430 MFZ430	- GBox: ZF - GBox: Fuller - Contained in xxxx.60.00
			 4309.26.00 ⊖	430 MFZ430	- GBox: ZF - GBox: Fuller - Contained in xxxx.60.00
			 8924.46.00	KZIZ5	- GBox: Fuller - Contained in xxxx.60.00
260...					
260 PAC 260 PAT			 4236.20.00	420 GF420KR	
			 4208.30.00	420 10 420GS	
			 8514.40.00	KZI - 4,5	



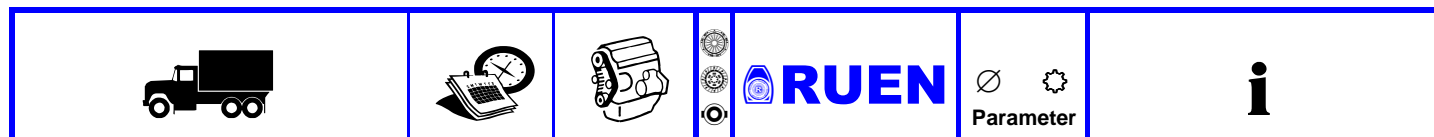



Vehicle list





































IVECO

260...					
260-26 H, HT, HW 260-26 N, NW 260 PAC 26 6x4, 6x6 260 PC 6x4, 6x6 260 PT 26 6x4			4200.90.49 4236.20.00 4265.30.00 8532.40.00	420 10 GF420KR 420GSZ KZI - 4,5	
			8514.40.00	KZI - 4,5	
260-35 H, HT 6x4 260-35 HW 6x6 260 PC HW 6x6 260 PT 35 6x4, 6x6			4278.20.00	420 GFX420KR	
			4268.30.00	420 10 420GSZ	
			8514.40.00	KZI - 4,5	
260-23			3895.20.00	380 G380KR	
			3812.30.00	380 10 380GSZ	
			7951.40.00	KZIS - 4	
260-23 AH 260-23 AHB 260-25 AHB	01.86 - 01.89 -		4237.20.00	420 GF420KR	- GBox: ZF
			4208.30.00	420 10 420GS	- GBox: ZF
			8514.40.00	KZI - 4,5	- GBox: ZF
260-23 AH	- 12.85		3895.20.00	380 G380KR	- GBox: ZF
			3816.30.00	380 10 380GSZ	- GBox: ZF
			8514.40.00	KZI - 4,5	- GBox: ZF
260-30 H			4200.90.49 4236.20.00 4265.30.00 8532.40.00	420 10 GF420KR 420GSZ KZI - 4,5	
			8514.40.00	KZI - 4,5	
260-32 AH			4299.20.00	420 GFX420K	- GBox: Fuller
			4268.30.00	420 10 420GSZ	- GBox: Fuller
			8514.40.00	KZI - 4,5	- GBox: Fuller
260-32 AHM 260-32 AHWM			4235.20.00	420 GF420KR	- GBox: ZF
			4237.30.00	420 10 420GSZ	- GBox: ZF
			8514.40.00	KZI - 4,5	- GBox: ZF
260-36			4300.90.37 ⊕ 4310.60.00 4327.30.00	430 10 MFZ430 430GTZ	- GBox: Fuller
			4300.90.06 ⊕ 4310.60.00 4326.30.00	430 10 MFZ430 430WGTZ	- GBox: ZF
			4309.26.00 ⊖	430 MFZ430	- GBox: Fuller - GBox: ZF - Contained in xxxx.60.00
			8924.46.00	KZIZ5	- GBox: Fuller - GBox: ZF - Contained in xxxx.60.00







Vehicle list

					
---	---	---	--	---	---

IVECO























260...							
260-48 Turbo Star	01.89 -			4300.90.04	430 10	- GBox: ZF	
				 4301.20.00  4326.30.00  8919.40.00	MFZ430 430WGTZ KZISZ - 5		
260-30 260-32				4300.90.02	430 10	- GBox: Fuller	
				 4301.20.00  4327.30.00  8919.40.00	MFZ430 430GTZ KZISZ - 5		
260-30 260-32				4247.30.00	420 10	- For PTO	
				420GSZ			
300...							
300 PC				4236.20.00	420	- To chassis no.: 014757	
					GF420KR		
300 PC Hydro				4299.30.00	420 10	- To chassis no.: 014757	
					420GSZ		
300 PC				4301.20.00	430		
					MFZ430		
300 PT				4299.30.00	420 10		
					420GSZ		
300-23				4236.20.00	420	- To chassis no.: 04386	
					GF420KR		
300-25 AHB				4299.30.00	420 10	- To chassis no.: 04386	
					420GSZ		
300-32 300-34				3804.20.00	380		
					G380KR		
					3812.30.00	380 10	
300-32 300-34					380GSZ		
					7951.40.00		KZIS - 4
300 PC				4235.20.00	420	- GBox: ZF	
					GF420KR		
					4208.30.00	420 10	- GBox: ZF
300 PC					420GS		
					8514.40.00		KZI - 4,5
300-32 300-34				4253.20.00	420		
					GFX420KR		
					4268.30.00	420 10	
300 PC					420GSZ		
					8514.40.00		KZI - 4,5
320-30 N	01.88 -			4299.30.00	420 10		
					420GSZ		
320-32 AHB				4278.20.00	420	- GBox: Fuller	
					GFX420KR		
320-32 AHB				4268.30.00	420 10	- GBox: Fuller	
					420GSZ		
320-32 AHB				8514.40.00		- GBox: Fuller	
330-26 H, HT 330-26 N 330 PAC 26 330 PC 26 6x4 330 PT 26 6x4				4253.20.00	420		
					GFX420KR		
					4268.30.00	420 10	
330-26 H, HT 330-26 N 330 PAC 26 330 PC 26 6x4 330 PT 26 6x4					420GSZ		
					8514.40.00		KZI - 4,5

Vehicle list



					
---	---	---	--	---	---

IVECO





330...

330 PC 26 (Version 42240569,42240611), (Version 42240590)			 4278.20.00	420 GFX420KR	- For: Version 42240590
			 4268.30.00	420 10 420GSZ	- For: Version 42240590
			 4235.20.00	420 GF420KR	- For: Version 42240569 - For: Version 42240611
			 4208.30.00	420 10 420GS	- For: Version 42240569 - For: Version 42240611
			 8514.40.00	KZI - 4,5	
330-25 AH, AN 330-26 AH, AN			 4237.20.00	420 GF420KR	
			 4268.30.00	420 10 420GSZ	
			 8514.40.00	KZI - 4,5	
330-30 N	- 12.87		 4200.90.49	420 10 GF420KR	
			 4236.20.00	420GSZ	
			 4265.30.00	KZI - 4,5	
			 8532.40.00		
			 8514.40.00	KZI - 4,5	
330-32 AN, ANW			 4298.20.00	420 GF420	
			 4268.30.00	420 10 420GSZ	
			 8514.40.00	KZI - 4,5	
330-35 H,HT,HN,HW Prod.-Nr. 42240			 4278.20.00	420 GFX420KR	
			 4268.30.00	420 10 420GSZ	
			 8514.40.00	KZI - 4,5	
330-36 AH, AHT	- 05.84 06.84 -		 4310.60.00 ⊕	430 MFZ430	
			 4309.26.00 ⊖	430 MFZ430	- Contained in xxxx.60.00
			 8924.46.00	KZIZ5	- Contained in xxxx.60.00
330-26 H 330-32 ANW 330-35 H, HT, HW 330 PC 35 330 PT 35			 4247.30.00	420 10 420GSZ	







340...

340-34			 4253.20.00	420 GFX420KR	
			 4268.30.00	420 10 420GSZ	
			 8514.40.00	KZI - 4,5	

613 - 619



613 N 3			 2514.20.00	250 H250K	- From chassis no.: 106895
			 2514.30.00	250 10 250CBL	- From chassis no.: 106895
616 N 3/4	05.76 -		 2514.20.00	250 H250K	
			 2514.30.00	250 10 250CBL	

Vehicle list

					
---	---	---	--	---	---



IVECO

613 - 619





619 NIP 016045-		4236.20.00	420 GF420KR	
		4299.30.00	420 10 420GSZ	

IVECO-FIAT (TÜRKİYE)



190 - 190.30 - 330.30

190.30		4277.20.00	420 GFX420KR	
		4268.30.00	420 10 420GSZ	

EUROSTAR - TECH - TRAKKER



EUROSTAR - TECH - TRAKKER		4301.20.00	430 MFZ430	- GBox: ZF / EATON
		4326.30.00	430 10 430WGTZ	- GBox: ZF
		4327.30.00	430 10 430GTZ	- GBox: EATON
		8919.40.00	KZISZ - 5	- GBox: ZF / EATON

STRALIS

STRALIS		4301.20.00	430 MFZ430	
		4326.30.00	430 10 430WGTZ	
		8919.40.00	KZISZ - 5	

KAELBLE

K 20

K 20 B		3822.20.00	380 GF380KR	
		3822.30.00	380 10 380GSZ	

K 410

K 410 Z		3552.30.00	350 10 350	
---------	---	------------	---------------	--



K 415

K 415 Z		3552.30.00	350 10 350	
---------	---	------------	---------------	--

K 631

K 631 ZB 62		3807.20.00	380 G380KR	
-------------	---	------------	---------------	--

K 632

K 632 ZB 15		4201.20.00	420 G420KR	
		8514.40.00	KZI - 4,5	

KDV 12

KDV 12 E 6		3804.20.00	380 G380KR	
------------	---	------------	---------------	--

KDV 22

KDV 22 E 6 T		3807.20.00	380 G380KR	
--------------	---	------------	---------------	--

KV 21



KV 21 E 6 T		3807.20.00	380 G380KR	
-------------	---	------------	---------------	--

Vehicle list

					
---	---	---	--	---	---

KAELBLE



KV 25

KV 25 B			 4201.20.00	420 G420KR	
			 8514.40.00	KZI - 4,5	
			 4250.20.00	420 GFX420KR	

KV 631

























KV 631 ZB 62			 3807.20.00	380 G380KR	
--------------	--	--	---	----------------------	--

KV 632







KV 632 ZB 12			 3807.20.00	380 G380KR	
KV 632 ZB 15			 4201.20.00	420 G420KR	
			 8514.40.00	KZI - 4,5	

KAMAZ

4 01.69 -

4307			 3607.20.00	362 MF362	- GBox: ZF-S5-42
			 3613.30.00	362 10 362GTZ	- GBox: ZF-S5-42
			 8533.40.00	KZI - 4,5	- GBox: ZF-S5-42
4308			 3607.20.00	362 MF362	- GBox: ZF-6S-850
			 3611.30.00	362 10 362GTZ	- GBox: ZF-6S-850
4308	01.03 -	B 5.9	 3607.20.00	362 MF362	- Engine code: B5.9 180 CIV-0 - Engine code: Cummins 4ISBe185 - GBox: ZF6S-850 - GBox: ZF 6S700
			 3611.30.00	362 10 362GTZ	- Engine code: B5.9 180 CIV-0 - GBox: ZF6S-850
			 7451.40.00	KZIS-4	- Engine code: B5.9 180 CIV-0 - GBox: ZF6S-850
			 3953.20.00	395 MF395	- Engine code: Cummins 4ISBe185 - GBox: AS-Tronic 6S1000To
			 3954.30.00	395 10 395WGTZ	- Engine code: Cummins 4ISBe185 - GBox: AS-Tronic 6S1000To
			 3612.30.00	362 10 362GTZ	- Engine code: Cummins 4ISBe185 - GBox: ZF 6S700
4355 43118	05.87 -	740.13 740.30	 4300.90.44	430 10 MFZ430	- Engine code: 740.30-260
			 4304.20.00	430WGTZ	
			 4316.30.00	KZIZ - 5	
			 8916.40.00		
4807 43255	01.03 -	B 5.9	 3607.20.00	362 MF362	- Engine code: B5.9 140 CIV-1 - GBox: S5-42
			 8533.40.00	KZI - 4,5	- Engine code: B5.9 140 CIV-1 - GBox: S5-42
43253			 3953.20.00	395 MF395	- Engine code: Cummins 6ISBe285 - GBox: ZF 6 S 1000
			 7451.40.00	KZIS-4	- Engine code: Cummins 6ISBe285 - GBox: ZF 6 S 1000
			 3965.30.00	395 10 15.5" 395GTZ	- Engine code: Cummins 6ISBe285 - GBox: ZF 6 S 1000
44108 45141	01.03 - 05.90 -	740.13 740.30	 4300.90.65	430 10 MFZ430	- Engine code: 740.30-260
			 4304.20.00	430GTZ	
			 4332.30.00	KZIZ - 5	
			 8916.40.00		



























Vehicle list

					
---	---	---	--	---	---

KAMAZ

5





























01.69 -

5297-15 5350			 4300.90.44  4304.20.00  4316.30.00  8916.40.00	430 10 MFZ430 430WGTZ KZIZ - 5	- Engine code: 740.31-240 - Engine code: KAMAZ / YAMZ, 740.30-260 - GBox: KAMAZ 154	
5308	05.11 -	ISBe4 300	 3953.20.00	395 MF395	- Engine code: Cummis ISBe 4 300 - GBox: ZF 16 S 109	
			 7451.40.00	KZIS-4	- Engine code: Cummis ISBe 4 300 - GBox: ZF 16 S 109	
5360, 191kW 5360, 265kW 5460	05.86 -	740.30	 4300.90.65	430 10 MFZ430 430GTZ KZIZ - 5	- Engine code: 740.30-260	
	05.86 -	740.50	 4304.20.00		- GBox: KAMAZ-154	
	05.03 -		 4332.30.00  8916.40.00		- GBox: 16S 151	
5490	12.13 -		 8939.40.00	KZISZ - 5	- Engine code: OM457 - GBox: ZF AS Tronic	
			 8916.40.00	KZIZ - 5	- Engine code: OM457 - GBox: ZF 16 S 2221	
53205 53215 53228 53229 53605, 176kW 54115 55111, Platform/Chassis, 6x4 55111, Dump Truck, 6x4	05.06 -	740.11	 3951.20.00	395 MF395	- Engine code: 740.11-240, 740.13-240, 740.31-240 - GBox: KAMAZ-152	
	05.04 -	740.31	 3870.30.00	380 10 380/210GSZ	- Vehicles with double disc clutch - Loose clutch disc	
	05.99 -				 3962.30.00	395 10 395GTZ
	05.99 -			 8533.40.00	KZI - 4,5	- Engine code: 740.11-240, 740.13-240, 740.31-240 - GBox: KAMAZ-152
	05.05 -					 3951.20.00
	05.84 -			 3962.30.00	395 10 395GTZ	- Engine code: KAMAZ / YAMZ, 740.31-240, 740.11-240, 740.13-260 - GBox: KAMAZ, 141 142 152
05.82 -			 8533.40.00	KZI - 4,5	- Engine code: KAMAZ / YAMZ, 740.31-240, 740.11-240, 740.13-260 - GBox: KAMAZ, 141 142 152	
53215	11.05 -		 4300.90.65	430 10 MFZ430 430GTZ KZIZ - 5	- Engine code: KAMAZ / YAMZ, 740.31-240 - GBox: ZF-Ecosplit 16S-151	
			 4304.20.00			
			 4332.30.00  8916.40.00			
			 4301.20.00	430 MFZ430	- Engine code: KAMAZ / YAMZ, 740.31-240 - GBox: ZF-Ecomit 9S-109	
			 4335.30.00	430 10 430GTZ	- Engine code: KAMAZ / YAMZ, 740.31-240 - GBox: ZF-Ecomit 9S-109	
			 8935.40.00	KZISZ - 5	- Engine code: KAMAZ / YAMZ, 740.31-240 - GBox: ZF-Ecomit 9S-109	







Vehicle list

					
---	---	---	--	---	---









KAMAZ

5						01.69 -					
53605, 191kW	05.05 -	740.30	 4300.90.65	430 10 MFZ430 430GTZ KZIZ - 5	- Engine code: 740.30-260 - GBox: KAMAZ-154						
			 4304.20.00								
			 4332.30.00								
			 8916.40.00								
			 3951.20.00			395 MF395	- Engine code: 740.11-240, 740.13-240, 740.31-240 - GBox: KAMAZ-152				
			 4301.20.00			430 MFZ430	- Engine code: 740.30-260 - GBox: KAMAZ-154				
			 4332.30.00			430 10 430GTZ	- Engine code: 740.30-260 - GBox: KAMAZ-154				
			 3870.30.00			380 10 380/210GSZ	- Vehicles with double disc clutch - Loose clutch disc				
 3962.30.00	395 10 395GTZ	- Engine code: 740.11-240, 740.13-240, 740.31-240 - GBox: KAMAZ-152									
			 8916.40.00	KZIZ - 5	- Engine code: 740.30-260 - GBox: KAMAZ-154						
			 8533.40.00	KZI - 4,5	- Engine code: 740.11-240, 740.13-240, 740.31-240 - GBox: KAMAZ-152						
6						01.69 -					
65206	12.13 -		 4301.20.00	430 MFZ430	- Engine code: OM457 - GBox: ZF 16 S 2221						
			 4300.30.00			430 10 430GTZ	- Engine code: OM457 - GBox: ZF 16 S 2221				
			 8916.40.00			KZIZ - 5	- GBox: OM457 - Engine code: ZF 16 S 2221				
63501 6450 6520-06 6522 65201 65224	05.03 -	740.50	 4300.90.65	430 10 MFZ430 430GTZ KZIZ - 5	- Engine code: 740.50-360 - GBox: 16S 151						
	05.02 -	740.51									
	01.03 -										
	05.05 -										
	05.06 - 05.05 -										
6460	10.03 -	740.50	 4300.90.65	430 10 MFZ430 430GTZ KZIZ - 5	- Engine code: 740.50-360; 740.51-320 - GBox: 16S 151						
			 4304.20.00								
			 4332.30.00								
 4301.20.00			430 MFZ430	- Engine code: 740.37-400 - GBox: 16S 151							
					 4300.30.00	430 10 430GTZ	- Engine code: 740.37-400 - GBox: 16S 151				
6520	05.03 -	740.51	 43461.30.00	430 10 430WGTZ	- Engine code: 740.51-320						
			 8950.40.00			KZIZ-6	- Engine code: 740.51-320				
			 4300.90.65			430 10 MFZ430 430GTZ KZIZ - 5	- Engine code: 740.50-360; 740.51-320 - GBox: ZF 16S 151				
 4304.20.00											
 4332.30.00											
6540 65111 65115, 25.20t, Dump Truck 65116 65117 65225	05.02 -	740.13	 4300.90.44	430 10 MFZ430 430WGTZ KZIZ - 5	- Engine code: 740.30-260 - GBox: KAMAZ-154						
		740.30									
	05.95 -	740.50									
	05.08 -										
	05.06 - 05.04 -										
 4304.20.00			4316.30.00	- Engine code: 740.30-260 - GBox: KAMAZ-154							
					 8916.40.00						

Vehicle list

					
---	---	---	--	---	---







KAMAZ

6		01.69 -				
65111 65115, 22.60t, Truck Tractor	05.00 -	740.13	 3951.20.00	395 MF395	- Engine code: KAMAZ / YAMZ, 740.31-240, 740.11-240, 740.13-260 - GBox: KAMAZ, 141 142 152	
	05.95 -		 3962.30.00	395 10 395GTZ	- Engine code: KAMAZ / YAMZ, 740.31-240, 740.11-240, 740.13-260 - GBox: KAMAZ, 141 142 152	
			 4300.90.65  4304.20.00  4332.30.00  8916.40.00	430 10 MFZ430 430GTZ KZIZ - 5	- Engine code: KAMAZ / YAMZ, 740.31-240 - GBox: ZF-Ecosplit 16S-151	
			 4335.30.00	430 10 430GTZ	- Engine code: KAMAZ / YAMZ, 740.31-240 - GBox: ZF-Ecomit 9S-109	
			 8935.40.00	KZISZ - 5	- Engine code: KAMAZ / YAMZ, 740.31-240 - GBox: ZF-Ecomit 9S-109	
			 8533.40.00	KZI - 4,5	- Engine code: KAMAZ / YAMZ, 740.31-240, 740.11-240, 740.13-260 - GBox: KAMAZ, 141 142 152	



KAROSA

7...					
732			 4293.30.00	420 10 420GSZ	
734					
735					
736					
744					







KRAUSS-MAFFEI AG

KMO 130					
KMO 130			 3552.30.00	350 10 350	
KMO 133					
KMO 133	- 12.51		 3552.30.00	350 10 350	
KMO 150					
KMO 150			 3506.20.00	350 G350	
KMS 120					
KMS 120			 3131.20.00	310 G310	
			 3155.30.00	310 10 310Z	
KMS 135					
KMS 135 R, RL			 3131.20.00	310 G310	
			 3155.30.00	310 10 310Z	

KRUPP









KRUPP					
AK - LF 501 L, K 401 L, LF 601			 3131.20.00	310 G310	
			 3155.30.00	310 10 310Z	

Vehicle list





					
---	---	---	--	---	---

KRUPP



KRUPP

AK - SF 360 (AK,F,K,KF,LF,) K - SF 960.2 (K,KF,L,LF,S,SF) K - SF 1060.2 (K,KF,L,LF,S,SF)		3807.20.00	380 G380KR	- GBox: AK 6-80
		3812.30.00	380 10 380GSZ	- GBox: AK 6-80
		8505.40.00	KZI - 4,5	- GBox: AK 6-80
AS 1060 (Kongo) K-SF 1065 CH (K,LF,S,SF)		3807.20.00	380 G380KR	
		3812.30.00	380 10 380GSZ	
		8505.40.00	KZI - 4,5	
AZ 1080 (AZ,KF,LF,SF) AZ-SF 980 (AZ,KF,LF,SF) SF 361 SF 380		3810.20.00	380 G380KR	
		3812.30.00	380 10 380GSZ	
		8505.40.00	KZI - 4,5	

KRUPP-ARDELT

6 GTK 12 GMT 12 GTT-S 40 GA, GM, GMü		3131.20.00	310 G310	
		3155.30.00	310 10 310Z	
10 H 18 GMT 20 GMT 25 GMT		4201.20.00	420 G420KR	
25 GM Autokran		2841.20.00	280 G280	
25 GM, GMü Mobilkran		2844.30.00	280 10 280Z	

KRUPP-DOLBERG

D 200 M D 451 M		2521.20.00	250 G250	
		2517.30.00	250 10 250	
D 451		2844.30.00	280 10 280Z	

LIAZ

150.000...



150.261 151.261		4293.30.00	420 10 420GSZ	
--------------------	---	-------------------	-------------------------	--

250.000...







250.261 251.261		4293.30.00	420 10 420GSZ	
--------------------	---	-------------------	-------------------------	--

LIEBHERR

Kran / crane



















AK 35 AK 40		2518.20.00	250 G250	
		2510.30.00	250 10 250Z	

Vehicle list



					
---	---	---	--	---	---

LIEBHERR



Kran / crane

LG 1130				3889.10.00	380 GF2/380	
LT 1050				3870.30.00	380 10 380/210GSZ	
LT 1055				3892.20.00	380 GF2/380	
LT 1110				3848.50.00	380 GF2/380	
				3871.30.00	380 10 380/70GSZ	
LI 1010				2518.20.00	250 G250	
				2518.30.00	250 10 250GSZ	
LT 1020				3822.20.00	380 GF380KR	
LT 1030						
LT 1060						
LT 1025				3583.30.00	350 10 350GSZ	
				8505.40.00	KZI - 4,5	
LT 1035				3821.20.00	380 GF380KR	
				3885.30.00	380 10 380GSZ	
				8500.40.00	KZI - 4,5	
LT 1045	05.75 -			3889.10.00	380 GF2/380	
LT 1080				3870.30.00	380 10 380/210GSZ	
				3892.20.00	380 GF2/380	
				3848.50.00	380 GF2/380	
				3871.30.00	380 10 380/70GSZ	

Mobilbagger / mobile excavator

A 350				2518.20.00	250 G250	
A 400				2510.30.00	250 10 250Z	
A 500 N						
A 353				2802.20.00	280 G280	

Raupenbagger / crawler excavat







MR 500 N				2518.20.00	250 G250	
R 350				2510.30.00	250 10 250Z	
R 400						
R 500 N						
R 353				2802.20.00	280 G280	

MAGIRUS-DEUTZ

A 3500 - S 5500



A 3500				2802.20.00	280 G280	
A 4500 (Mercur)						
S 3500						
S 4500						

Vehicle list



					
---	---	---	--	---	---

MAGIRUS-DEUTZ

A 3500 - S 5500

S 4500 , F3, M6, TW6 (Chassis K 3500)		2802.20.00	280 G280
S 4500 F		3505.20.00	350 G350KR
S 4500 S		3519.30.00	350 10 350GSZ
S 5500			







Jupiter

Jupiter 6x6 Z		3804.20.00	380 G380KR
		3899.30.00	380 10 380GSZ







Mercur

Mercur A		2802.20.00	280 G280
Mercur S			



Saturn

Saturn		3505.20.00	350 G350KR
		3519.30.00	350 10 350GSZ
Saturn -Europawagen		3895.20.00	380 G380KR
		3812.30.00	380 10 380GSZ
		8505.40.00	KZI - 4,5
Saturn 145 a		3505.20.00	350 G350KR
		3519.30.00	350 10 350GSZ



70...

70 D 6 FL		2518.20.00	250 G250
		2518.30.00	250 10 250GSZ
70 M 6 FL		2820.20.00	280 MF280
		2832.30.00	280 10 280GTZ
		6905.40.00	KZIS - 3
75 D 6 FL		2518.20.00	250 G250
		2518.30.00	250 10 250GSZ







80...

80 D 6/7/8 FK		2518.20.00	250 G250
		2518.30.00	250 10 250GSZ





















90...

90 D 5,2 FL,FV,FK		2820.20.00	280 MF280
90 D 5,6 FL,FV,FK			
90 D 6,0 FL,FV,FK		2832.30.00	280 10 280GTZ
90 D 6,5 FL,FV,FK			
90 D 7,5 FL,FV,FK		6905.40.00	KZIS - 3
90 M 6 FL,FK			
90 M 7 FL,FG,FGB,FK			
90 M 8 FL,FK			
90 M 9 FL			

Vehicle list

					
---	---	---	--	---	---

MAGIRUS-DEUTZ













90...						
90 M 5,3 FL,FV,FK	- 02.82			2810.20.00	280 H280K	
90 M 5,7 FL,FV,FK	- 02.82					
90 M 5,9 FL,FV,FK	- 02.82			2810.30.00	280 10 280CBL	
90 M 6,0 FL,FK,FV	- 02.82					
90 M 6,6 FL,FV,FK	- 02.82			5800.40.00	KZA - 2	
90 M 7,5 FL,FV,FK	- 02.82					
90 M 7,9 FL, FV, FK	- 02.82					
90 M 9,0	- 02.82					
100...						
100 R				3505.20.00	350 G350KR	- GBox: ZF S-6/80
				3512.30.00	350 10 350W2GSZ	- GBox: ZF S-6/80
110...						
112 D 9 AS				3505.20.00	350 G350KR	
				3519.30.00	350 10 350GSZ	
110 E 6				2819.30.00	280 10 280GSZ	
120...						
120				3131.20.00	310 G310	
120 F						
125 D 10 A				3108.30.00	310 310GSZ	
126						
126 AK						
126 D 11						
126 F						
120 D 7/9/11				2819.30.00	280 10 280GSZ	
126 D 12, 14 F				3131.20.00	310 G310	
				3108.30.00	310 310GSZ	
130...						
130 D 7 FA				6905.40.00	KZIS - 3	
130 D 9 AL	- 06.77					
130 D 9 AS,L				2955.20.00	295 GF295	
130 D 13 AK	- 03.77					
130 D 13 K,L						
130 D 14 FL						
130 D 15 AK, K						
130 D 17 FA						
130 D 9 AL	07.77 -			3563.20.00	350 GMF350	
				3564.30.00	350 10 350GSZ	
				8514.40.00	KZI - 4,5	
130 D 9 FA				2955.20.00	295 GF295	- For: Version 2550361
				6905.40.00	KZIS - 3	- For: Version 2550361

Vehicle list





					
---	---	---	--	---	---

MAGIRUS-DEUTZ









130...

130 D 9 FA, FL				3162.20.00	310 MF310	
130 D 11 FL				3113.30.00	310 10 310GSBL	
130 D 12 AK, K				6905.40.00	KZIS - 3	
130 D 13 FL						
130 D 15 K						
130 D 16 FL, FLL						
130 M 7 FL, FAL						
130 M 8 FL, FS, FK, FAL						
130 M 9 FL, FS, FK, FG						
130 M 11 FL, FK						
130 M 13 FL						
130 M 13 FL, FGB, FK						
130 D 11 F, H, K				2955.20.00	295 GF295	
130 D 12 F, H, K				6905.40.00	KZIS - 3	
130 D 15 F, H, K						
130 D 13 AK	04.77 -			3563.20.00	350 GMF350	
				3564.30.00	350 10 350GSZ	
				8505.40.00	KZI - 4,5	
135 D 10, D 12, D 14 FS, FL				3131.20.00	310 G310	
				3108.30.00	310 310GSZ	
130 L 81				3162.20.00	310 MF310	- Engine code: F6 L913
130 R 81				3140.30.00	310 10 310W2GSZ	- Engine code: F6 L913
				6905.40.00	KZIS - 3	- Engine code: F6 L913







140...

140 D 11 F, K, AK				3505.20.00	350 G350KR	
				3519.30.00	350 10 350GSZ	
145 AK 6x6				3505.20.00	350 G350KR	
				3519.30.00	350 10 350GSZ	

150...









150 ,150/1F	- 02.62			3505.20.00	350 G350KR	
150 AK 6x6				3519.30.00	350 10 350GSZ	
150 D 13 FL, FS						
150 D 14						
156 D 15 K						
150 AK 6x6	03.62 -			3505.20.00	350 G350KR	
150 L 6x4				3519.30.00	350 10 350GSZ	
156 D 22						
150 D 10 A				3519.30.00	350 10 350GSZ	
150 D 14 AK				3131.20.00	310 G310	
				3108.30.00	310 310GSZ	
150 D 22 FL 6x4				3505.20.00	350 G350KR	
				3519.30.00	350 10 350GSZ	

Vehicle list























					
---	---	---	--	---	---

MAGIRUS-DEUTZ







150...

156 D 14 K				3505.20.00	350 G350KR	
156 D 15 AK				3519.30.00	350 10 350GSZ	
156 D 16 AK						
150 E 100				3505.20.00	350 G350KR	
150 R/L 10				3512.30.00	350 10 350W2GSZ	
150 S 10						
150 R/L 10, 12				3505.20.00	350 G350KR	
				3519.30.00	350 10 350GSZ	
150 S 11 M				3807.20.00	380 G380KR	- Engine code: F6 L413
				3805.30.00	380 10 380WGSZ	- Engine code: F6 L413

























160...

160 D 11 FL, FS				3573.20.00	350 MF350	
160 D 12 K				3563.30.00	350 10 350GSZ	
160 D 15 K				6905.40.00	KZIS - 3	
160 D 16 FL, FLL						
160 M 11 FL, FS						
160 D 11-D 17				3563.20.00	350 GMF350	
				3519.30.00	350 10 350GSZ	
				8514.40.00	KZI - 4,5	
160 D 12 AK	01.82 -			3563.20.00	350 GMF350	
168 M 13 FL				3583.30.00	350 10 350GSZ	
168 M 16 FL				8514.40.00	KZI - 4,5	
160 D 12 AK	- 12.81			2955.20.00	295 GF295	
				6905.40.00	KZIS - 3	
160 D 16 FL				3563.20.00	350 GMF350	
				3519.30.00	350 10 350GSZ	
160 M 11 FA, FS, FK				3570.20.00	350 GMF350	
160 M 13 FL, FS, FK				3585.30.00	350 10 350GSZ	
160 M 7 FA				6905.40.00	KZIS - 3	
160 M 8 FL, FAL						
168 M 11 FL, FAL						
160 M 11 FK (Version 2550435)				3166.20.00	310 MF310	
				3113.30.00	310 10 310GSBL	
				6905.40.00	KZIS - 3	
168 M 14 FK				3563.20.00	350 GMF350	
168 M 14 FL (Version 42230423)				3565.20.00	350 GMF350	
				3585.30.00	350 10 350GSZ	
				8514.40.00	KZI - 4,5	







Vehicle list

					
---	---	---	--	---	---





























MAGIRUS-DEUTZ

160...					
168 M 14 FL			 3563.20.00	350 GMF350	- For: Version 61602271
			 3564.30.00	350 10 350GSZ	- For: Version 61602271
			 8514.40.00	KZI - 4,5	- For: Version 61602271
160 L 81 160 R 81			 3300.20.00	330 GFM330	
			 3328.30.00	330 10 330WGSZ	
			 6905.40.00	KZIS - 3	
170...					
170 D 10 AK 170 D 11 F 170 D 11 FA 170 D 21 AK 6x6		- 11.83	 3505.20.00	350 G350KR	
			 3519.30.00	350 10 350GSZ	
			 8514.40.00	KZI - 4,5	
170 D 11 FA	12.83 -		 3563.20.00	350 GMF350	
			 3564.30.00	350 10 350GSZ	
			 8514.40.00	KZI - 4,5	
170 D 11 FL 170 D 12 AK, AL 170 D 12, FL 170 D 13 FS, FL 170 D 15 AK, FAK, FK, K 170 D 15 FL 170 D 16 FL 170 D 16 K 170 D 17 F, K, AK 170 D 19 L, FL, AL 170 D 24 K, L			 3505.20.00	350 G350KR	
			 3512.30.00	350 10 350W2GSZ	
			 3505.20.00	350 G350KR	
			 3512.30.00	350 10 350W2GSZ	
			 3804.20.00	380 G380KR	
			 3805.30.00	380 10 380WGSZ	
			 3505.20.00	350 G350KR	
			 3512.30.00	350 10 350W2GSZ	
			 3807.20.00	380 G380KR	- Engine code: F6 L413
			 3805.30.00	380 10 380WGSZ	- Engine code: F6 L413
180...					
180 D 12 FL			 3519.30.00	350 10 350GSZ	
180 LS 12			 3505.20.00	350 G350KR	
			 3519.30.00	350 10 350GSZ	







Vehicle list

					
---	---	---	--	---	---

MAGIRUS-DEUTZ



180...					
186 D 13 FL 186 D 15 FL 186 D 17 FL				3519.30.00	350 10 350GSZ
190...					
190 D 9 AL				2955.20.00	295 GF295
				6905.40.00	KZIS - 3
192 D 11 F, FA 192 D 13 F 192 M 12 FA				3563.20.00	350 GMF350
				3564.30.00	350 10 350GSZ
				8514.40.00	KZI - 4,5
192 D 12 AL				3563.20.00	350 GMF350
				3564.30.00	350 10 350GSZ
				7951.40.00	KZIS - 4
192 M 14 FL 2				3804.20.00	380 G380KR
				3816.30.00	380 10 380GSZ
				8514.40.00	KZI - 4,5
192 M 14 FL, FS 192 M 16 F, FL, FS				3810.20.00	380 G380KR
				3816.30.00	380 10 380GSZ
195 195 L				3804.20.00	380 G380KR
				3899.30.00	380 10 380GSZ
195				3804.20.00	380 G380KR
				3899.30.00	380 10 380GSZ
195 D				3804.20.00	380 G380KR
				3805.30.00	380 10 380WGSZ
200...					
200 D 15 FAK 200 D 18				3804.20.00	380 G380KR
				3812.30.00	380 10 380GSZ
200 D 16 200 D 26 200 D F, K, AK, S, L 200 D FS, FL 6x4				3804.20.00	380 G380KR
				3899.30.00	380 10 380GSZ
200 D 16 F 200 D 22 B				3804.20.00	380 G380KR
				3812.30.00	380 10 380GSZ
				7951.40.00	KZIS - 4
200 E 12 200 LS /RS 12 200 R/L 200 SH 110				3807.20.00	380 G380KR - Engine code: F8 L312
				3805.30.00	380 10 380WGSZ - Engine code: F8 L312

Vehicle list













					
---	---	---	--	---	---

MAGIRUS-DEUTZ







200...

200 E 110		3804.20.00	380 G380KR	
		3805.30.00	380 10 380WGSZ	









210...

210 D 16 210 D 16 F		3810.20.00	380 G380KR	
		3812.30.00	380 10 380GSZ	
		3861.30.00	380 10 380W2GSZ	
210 D 16 AK		3804.20.00	380 G380KR	
		3812.30.00	380 10 380GSZ	
		3861.30.00	380 10 380W2GSZ	
		7951.40.00	KZIS - 4	
210 D 22 210 D 26 K		3804.20.00	380 G380KR	
		3812.30.00	380 10 380GSZ	
		7951.40.00	KZIS - 4	
210 D 18		3804.20.00	380 G380KR	
		3812.30.00	380 10 380GSZ	







220...

228 M 16 AK		3895.20.00	380 G380KR	
		3816.30.00	380 10 380GSZ	
		8514.40.00	KZI - 4,5	
226 L 117		4298.20.00	420 GF420	- GBox: S 4-90
		4249.30.00	420 10 420W2GSZ	- GBox: S 4-90
		8514.40.00	KZI - 4,5	- GBox: S 4-90

































230...

230 D 16 F		3810.20.00	380 G380KR	
		3812.30.00	380 10 380GSZ	
		7951.40.00	KZIS - 4	
230 D 16 FAK		3804.20.00	380 G380KR	
		3812.30.00	380 10 380GSZ	
230 D 18 AK 230 D 19 FL 230 D 22 K		3810.20.00	380 G380KR	
		3812.30.00	380 10 380GSZ	
		3861.30.00	380 10 380W2GSZ	

Vehicle list

					
---	---	---	--	---	---

MAGIRUS-DEUTZ

230...					
230 D 22 FT 6x6				3804.20.00	380 G380KR
				3812.30.00	380 10 380GSZ
				3861.30.00	380 10 380W2GSZ
				7951.40.00	KZIS - 4
230 D 26 AK				3810.20.00	380 G380KR
				3812.30.00	380 10 380GSZ
232 D 15 FK, FAK, FS, FL 232 D 16 F, AK, FS, FL 232 D 19 AK, K, FAK, FK, FL, FS, L, S 232 D 22 AK, FAK, FK 6x6, FB 6x4 232 D 24 L, K, FK 232 D 26 AK, F, FAK, FB, FK, K, L, S				3804.20.00	380 G380KR
				3812.30.00	380 10 380GSZ
				3861.30.00	380 10 380W2GSZ
				7951.40.00	KZIS - 4
232 D 16 AL 232 D 20 AL				3895.20.00	380 G380KR
				3816.30.00	380 10 380GSZ
				8514.40.00	KZI - 4,5
232 D 17				4226.20.00	420 GF420KR
				4222.20.00	420 GF420KR
				4236.30.00	420 10 420/210GSZ
				8514.40.00	KZI - 4,5
232 D 17 F, FA 232 D 19 K, L 232 D 26 K 6x4				3804.20.00	380 G380KR
				3812.30.00	380 10 380GSZ
				7951.40.00	KZIS - 4
232 D 17 FA (Version 42230187)				3563.20.00	350 GMF350
				3564.30.00	350 10 350GSZ
				8514.40.00	KZI - 4,5
232 D 20 AL (Version 2551578) 232 D 26 B 232 D 32 K				3804.20.00	380 G380KR
				3812.30.00	380 10 380GSZ
				7951.40.00	KZIS - 4
232 D 30 AK, FAK 232 D 30 FK 232 D 32 A				3804.20.00	380 G380KR
				3812.30.00	380 10 380GSZ
				3861.30.00	380 10 380W2GSZ
				7951.40.00	KZIS - 4
235 D 22 FL, FS 6x4				3895.20.00	380 G380KR
				3812.30.00	380 10 380GSZ
				7951.40.00	KZIS - 4

Vehicle list









MAGIRUS-DEUTZ

230...





230 E 100 230 E 110		3804.20.00	380 G380KR	
		3805.30.00	380 10 380WGSZ	
		8505.40.00	KZI - 4,5	
230 E 100 (Version 2547021)		3505.20.00	350 G350KR	
		3512.30.00	350 10 350W2GSZ	
230 E 113 (Version 2547018) 230 E 120 230 L 120 230 T 117		3804.20.00	380 G380KR	
		3805.30.00	380 10 380WGSZ	
		8514.40.00	KZI - 4,5	
230 E 113 (Version 42246020/42/71) 230 E 117 230 T 117 (Version 42246022)		3804.20.00	380 G380KR	
		3857.30.00	380 10 380W2GSZ	
		8514.40.00	KZI - 4,5	
230 E 113 (Version 42246069)		3895.20.00	380 G380KR	
		3857.30.00	380 10 380W2GSZ	
		8514.40.00	KZI - 4,5	
230 E 113 (Version 42246073)		4237.20.00	420 GF420KR	
		4249.30.00	420 10 420W2GSZ	
		4272.30.00	420 10 420WGSZ	
		8514.40.00	KZI - 4,5	
230 EV 110 230 EV 120		3804.20.00	380 G380KR	
		3857.30.00	380 10 380W2GSZ	
		8505.40.00	KZI - 4,5	
230 L 117		3804.20.00	380 G380KR	- GBox: S 6-70/3, S 6-65
		3805.30.00	380 10 380WGSZ	- GBox: S 6-70/3
		3857.30.00	380 10 380W2GSZ	- GBox: S 6-65
		6905.40.00	KZIS - 3	- GBox: S 6-70/3, S 6-65
		4298.20.00	420 GF420	- Engine code: F8 L413F - GBox: S 6-65
		4249.30.00	420 10 420W2GSZ	- Engine code: F8 L413F - GBox: S 6-65
		8514.40.00	KZI - 4,5	- Engine code: F8 L413F - GBox: S 6-65
230 R 100 230 R 120 230 TR 100 230 TR 120		3804.20.00	380 G380KR	- Engine code: F8 L413
		3805.30.00	380 10 380WGSZ	- Engine code: F8 L413

Vehicle list



























					
---	---	---	--	---	---

MAGIRUS-DEUTZ

230...

230 SH 110		3804.20.00	380 G380KR	- GBox: S 6-70/3
		3805.30.00	380 10 380WGSZ	- GBox: S 6-70/3
		6905.40.00	KZIS - 3	- GBox: S 6-70/3
		3895.20.00	380 G380KR	- GBox: F8 L914
		3816.30.00	380 10 380GSZ	- GBox: F8 L914

250...

























250 D 22		3895.20.00	380 G380KR	
		3812.30.00	380 10 380GSZ	
		7951.40.00	KZIS - 4	
250 D 22 FK 6x4		3804.20.00	380 G380KR	
		3812.30.00	380 10 380GSZ	
		3861.30.00	380 10 380W2GSZ	
		7951.40.00	KZIS - 4	
250 D 22 FK 6x4 (10 Zyl.)		3895.20.00	380 G380KR	
		3812.30.00	380 10 380GSZ	
		3861.30.00	380 10 380W2GSZ	
		7951.40.00	KZIS - 4	
256 D 14 F 256 D 16 AK (Version 2551676) 256 D 16 FS, FL, FLL, K 256 D 19 AK, FL,FS, K, S 256 D 22 FLL 256 D 26 AK, K, 6x4 256 D 26 FB 6x4		3895.20.00	380 G380KR	
		3816.30.00	380 10 380GSZ	
		8514.40.00	KZI - 4,5	
256 D 16 FB 6x4 (Version 42231436)		3810.20.00	380 G380KR	
		3816.30.00	380 10 380GSZ	
		7951.40.00	KZIS - 4	
256 M 19 256 M 22		4298.20.00	420 GF420	- GBox: ZF S 6-90 - GBox: Fiat E 100
		4208.30.00	420 10 420GS	- GBox: ZF S 6-90 - GBox: Fiat E 100
		8538.40.00	KZI-4,5	- GBox: ZF S 6-90 - GBox: Fiat E 100
256 M 19 A, AT		4298.20.00	420 GF420	- GBox: Fuller
		4208.30.00	420 10 420GS	- GBox: Fuller
		8512.40.00	KZI - 4,5	- GBox: Fuller
256 M 19 AK	12.84 -		4237.20.00	420 GF420KR
		4268.30.00	420 10 420GSZ	
		8514.40.00	KZI - 4,5	

Vehicle list







					
---	---	---	--	---	---

MAGIRUS-DEUTZ







250...

256 M 19 AK, AS, K, L, S 256 M 19 FAK, FK, FKL, FKS	- 11.84		 4237.20.00	420 GF420KR	- GBox: ZF
	- 11.84		 4208.30.00	420 10 420GS	- GBox: ZF
			 8514.40.00	KZI - 4,5	- GBox: ZF
256 M 19 F, FL, FS, FSL 256 M 22 F, FL, FS, FSL			 4237.20.00	420 GF420KR	- GBox: ZF
			 4208.30.00	420 10 420GS	- GBox: ZF
			 8538.40.00	KZI-4,5	- GBox: ZF
256 M 19 FL, FS, FSL 256 M 22 FL, FS, FSL			 4237.20.00	420 GF420KR	- GBox: Fuller
			 4208.30.00	420 10 420GS	- GBox: Fuller - GBox: Fiat E 90
			 8512.40.00	KZI - 4,5	- GBox: Fuller
256 M 19 FLL			 4298.20.00	420 GF420	
			 4208.30.00	420 10 420GS	
			 8512.40.00	KZI - 4,5	
256 M 26 AK 6x6, K, S 6x4 256 M 26 AK Prod.-Nr. 77311 256 M 26 FAK, FK, FKL, FKS 256 M 26 K, L, S Prod.-Nr. 77211			 4237.20.00	420 GF420KR	- GBox: ZF
			 4268.30.00	420 10 420GSZ	- GBox: ZF
			 8514.40.00	KZI - 4,5	- GBox: ZF
256 M 26 FB, L 6x4			 3895.20.00	380 G380KR	- GBox: ZF
			 3816.30.00	380 10 380GSZ	- GBox: ZF
			 8514.40.00	KZI - 4,5	- GBox: ZF
256 M 26 K (Version 42230027)			 3563.20.00	350 GMF350	
			 3564.30.00	350 10 350GSZ	
			 8514.40.00	KZI - 4,5	
256 M 33 K, FK			 4237.20.00	420 GF420KR	
			 4268.30.00	420 10 420GSZ	
			 8514.40.00	KZI - 4,5	































260...

260 D FAL 6x6			 4226.20.00	420 GF420KR	
			 4222.20.00	420 GF420KR	
			 4236.30.00	420 10 420/210GSZ	
			 8514.40.00	KZI - 4,5	
260 E 113 (Version 42246065/70)			 3895.20.00	380 G380KR	
			 3857.30.00	380 10 380W2GSZ	
			 8514.40.00	KZI - 4,5	

Vehicle list

					
---	---	---	--	---	---



























MAGIRUS-DEUTZ

260...					
260 E 113 (Version 42246068) 260 T 117		3804.20.00	380 G380KR		
		3857.30.00	380 10 380W2GSZ		
		8514.40.00	KZI - 4,5		
260 E 113 (Version 42246073/79)		4237.20.00	420 GF420KR		
		4249.30.00	420 10 420W2GSZ		
		4272.30.00	420 10 420WGSZ		
		8514.40.00	KZI - 4,5		
260 L 117		3804.20.00	380 G380KR	- GBox: S 6-65	
		3857.30.00	380 10 380W2GSZ	- GBox: S 6-65	
		6905.40.00	KZIS - 3	- GBox: S 6-65	
		4298.20.00	420 GF420	- Engine code: F8 L413F	
		4249.30.00	420 10 420W2GSZ	- Engine code: F8 L413F	
		8514.40.00	KZI - 4,5	- Engine code: F8 L413F	
260 R 106 260 R 119		4237.20.00	420 GF420KR		
		4272.30.00	420 10 420WGSZ		
		8514.40.00	KZI - 4,5		
260 SH 110		4298.20.00	420 GF420	- Engine code: F8 L413F - GBox: S 6-65	
		4249.30.00	420 10 420W2GSZ	- Engine code: F8 L413F - GBox: S 6-65	
		8514.40.00	KZI - 4,5	- Engine code: F8 L413F - GBox: S 6-65	
270...					
270 D 16 FAK, FK 270 D 19 270 D 22 FL, FLL, FS 270 D 26 AK, FAK		4224.20.00	420 GF420KR		
		4235.20.00	420 GF420KR		
		4236.30.00	420 10 420/210GSZ		
		8514.40.00	KZI - 4,5		
280...					
280 M 26 FS		4224.20.00	420 GF420KR		
		4235.20.00	420 GF420KR		
		4257.30.00	420 10 420GSZ		
		8514.40.00	KZI - 4,5		
280 E 113		4237.20.00	420 GF420KR		
		4249.30.00	420 10 420W2GSZ		
		4272.30.00	420 10 420WGSZ		
		8514.40.00	KZI - 4,5		







Vehicle list

					
---	---	---	--	---	---

MAGIRUS-DEUTZ





















290...					
290 D 19 K				4226.20.00	420 GF420KR
290 D 19 L				4222.20.00	420 GF420KR
290 D 22				4236.30.00	420 10 420/210GSZ
290 D 26 K				8514.40.00	KZI - 4,5
290 D 26 L				4299.20.00	420 GFX420K - GBox: Fuller
290 D 19 Turbo				4268.30.00	420 10 420GSZ - GBox: Fuller
				8512.40.00	KZI - 4,5 - GBox: Fuller
290 D 22 FK 6x4 (10 Zyl.)				3895.20.00	380 G380KR
				3812.30.00	380 10 380GSZ
				3861.30.00	380 10 380W2GSZ
				7951.40.00	KZIS - 4
290 D 26 FAL 6x6				4226.20.00	420 GF420KR
				4222.20.00	420 GF420KR
				4236.30.00	420 10 420/210GSZ
				8514.40.00	KZI - 4,5
290 M 19 FL, FS				4299.20.00	420 GFX420K
290 M 22 AP, FL, FLL				4268.30.00	420 10 420GSZ
				8512.40.00	KZI - 4,5
310...					
310 D 15 AK, FAK, FK, FL, FS, K				4224.20.00	420 GF420KR
310 D 16 AK, FAK, FK, FLL, FS, K, S	- 10.76			4235.20.00	420 GF420KR
310 D 16 FL				4236.30.00	420 10 420/210GSZ
310 D 16 FSL (Version 42230102)				8514.40.00	KZI - 4,5
310 D 19 AK, FAK, FK, FL, FS, S					
310 D 21 F					
310 D 22 AK, FAK, FAL, FK, FL, FS					
310 D 22 FA (Version 42230120)					
310 D 26 AK, FAK, FK, FS, S					
310 D 28 FK, FL					
310 D 32 K	- 06.76				
310 D 16 FL	11.76 -			4250.20.00	420 GFX420KR
				4236.30.00	420 10 420/210GSZ
				8514.40.00	KZI - 4,5
310 D 16 FSL (Version 2550517)				3505.20.00	350 G350KR
				3512.30.00	350 10 350W2GSZ

Vehicle list











					
---	---	---	--	---	---

MAGIRUS-DEUTZ

310...

310 D 26 AK (Version 2551686) 310 D 26 K (Version 42231407)			 4224.20.00	420 GF420KR	
			 4235.20.00	420 GF420KR	
			 4236.30.00	420 10 420/210GSZ	
			 8514.40.00	KZI - 4,5	
310 D 26 K (Version 2551652)			 4226.20.00	420 GF420KR	
			 4222.20.00	420 GF420KR	
			 4235.30.00	420 10 420/210GS	
			 8514.40.00	KZI - 4,5	
310 D 232			 3804.20.00	380 G380KR	
			 3812.30.00	380 10 380GSZ	
			 3861.30.00	380 10 380W2GSZ	
			 7951.40.00	KZIS - 4	
310 D 32 AK 310 D 32 K 310 D 32 L	- 01.78 07.76 - 01.78 - 01.78		 4208.30.00	420 10 420GS	
			 8514.40.00	KZI - 4,5	
310 D 32 AK 6x6 HD	02.78 -		 4298.20.00	420 GF420	
			 4268.30.00	420 10 420GSZ	
			 8514.40.00	KZI - 4,5	
310 D 32 K 310 D 32 L	02.78 - 02.78 -		 4298.20.00	420 GF420	
			 4208.30.00	420 10 420GS	
			 8514.40.00	KZI - 4,5	
310 D 22 FA (Version 42230008) 310 D 26 FAK (Version 42241400) 310 D 26 FK 6x4			 4247.30.00	420 10 420GSZ	- For PTO

320...

320 D 19 FAK 320 M 33 AK, K, L			 4298.20.00	420 GF420	
			 4268.30.00	420 10 420GSZ	
			 8514.40.00	KZI - 4,5	
320 D 20 AL, AS, FAT, FS			 4224.20.00	420 GF420KR	
			 4235.20.00	420 GF420KR	
			 4236.30.00	420 10 420/210GSZ	
			 8514.40.00	KZI - 4,5	
320 D 21 HL 320 D 26 AK			 4226.20.00	420 GF420KR	
			 4222.20.00	420 GF420KR	
			 4236.30.00	420 10 420/210GSZ	
			 8514.40.00	KZI - 4,5	

Vehicle list









MAGIRUS-DEUTZ





















320...

320 D 26 AL	11.83 -			4299.20.00	420 GFX420K	
				4272.30.00	420 10 420WGSZ	
				8514.40.00	KZI - 4,5	
320 D 26 AL	- 10.83			4298.20.00	420 GF420	
				4272.30.00	420 10 420WGSZ	
				8514.40.00	KZI - 4,5	
320 D 26 F, FA, FT				4226.20.00	420 GF420KR	
				4235.20.00	420 GF420KR	
				4236.30.00	420 10 420/210GSZ	
				8514.40.00	KZI - 4,5	
320 D 34 AS				4298.20.00	420 GF420	
				4208.30.00	420 10 420GS	
				8514.40.00	KZI - 4,5	
320 M 19 320 M 22				4299.20.00	420 GFX420K	- GBox: ZF
				4268.30.00	420 10 420GSZ	- GBox: ZF
				8514.40.00	KZI - 4,5	- GBox: ZF
				8512.40.00	KZI - 4,5	- GBox: Fuller
320 M 19 A, AT				4298.20.00	420 GF420	- GBox: Fuller
				4268.30.00	420 10 420GSZ	- GBox: Fuller
				8514.40.00	KZI - 4,5	- GBox: Fuller
320 M 19 FAK, FK, FKL, FKS				4299.20.00	420 GFX420K	- GBox: ZF
				4268.30.00	420 10 420GSZ	- GBox: ZF
				8514.40.00	KZI - 4,5	- GBox: ZF
320 M 19 FL, FS, FSL 320 M 22 FL, FS, FSL				4298.20.00	420 GF420	- GBox: Fuller
				4268.30.00	420 10 420GSZ	- GBox: Fuller
				8514.40.00	KZI - 4,5	- GBox: Fuller
320 M 26 FAK 6x6 320 M 26 FK, FKL, FKS (6x4),				4298.20.00	420 GF420	- GBox: ZF
				4268.30.00	420 10 420GSZ	- GBox: ZF
				8514.40.00	KZI - 4,5	- GBox: ZF
320 M 26 FK, FKL				4299.20.00	420 GFX420K	- GBox: Fuller
				4268.30.00	420 10 420GSZ	- GBox: Fuller
				8514.40.00	KZI - 4,5	- GBox: Fuller
320 M 26 FAK				4247.30.00	420 10 420GSZ	- Engine code: F10 L413F

Vehicle list

					
---	---	---	--	---	---

MAGIRUS-DEUTZ

340...					
340 D 16 FS, FL 6x4 340 D 22 FS, FL 6x4	05.72 -		 4250.20.00	420 GFX420KR	
			 4236.30.00	420 10 420/210GSZ	
			 8514.40.00	KZI - 4,5	
350...					
350 F 33 , PC, PT			 4277.20.00	420 GFX420KR	- GBox: Fiat
			 4268.30.00	420 10 420GSZ	
			 8514.40.00	KZI - 4,5	- GBox: Fiat
360...					
360 D 18 FL, FS			 4299.20.00	420 GFX420K	
			 4208.30.00	420 10 420GS	
			 8514.40.00	KZI - 4,5	
360 M 19 A, AT 360 M 22 AP, APT			 4310.60.00 ⊕	430 MFZ430	
			 4327.30.00	430 10 430GTZ	
			 4309.26.00 ⊖	430 MFZ430	
			 8924.40.00	KZIZ5	
360 M 19 APT			 4299.20.00	420 GFX420K	
			 4268.30.00	420 10 420GSZ	
			 8512.40.00	KZI - 4,5	
360 M 33 F, FKS			 4334.60.00 ⊕	430 MFZ430	
			 4299.30.00	420 10 420GSZ	
			 4309.26.00 ⊖	430 MFZ430	
			 8930.40.00	KZI/Z-5	

Vehicle list



MAN

E 2000 05.00 -

19.310 FALK, FALK-L E62	05.00 -		4028.10.00	400 MFZ2/400X	- GBox: ZF Ecosplit-3 - Vehicles with double disc clutch - This part number includes one clutch disc	
19.310 FALS E62	05.00 -			4036.30.00	400 10 400 WGTZ	- GBox: ZF Ecosplit-3 - Vehicles with double disc clutch
19.310 FLK E61	05.00 -				8941.40.00	KZISZ-5
19.310 FLS E61	05.00 -					
19.360 FALK, FALK-L E62	05.00 -					
19.360 FALS E62	05.00 -					
19.360 FLK E61	05.00 -					
19.360 FLS E61	05.00 -					
19.410 FALK, FALK-L E62	05.00 -					
19.410 FALS E62	05.00 -					
19.410 FLK E61	05.00 -					
19.410 FLS E61	05.00 -					
19.460 FALK, FALK-L E62	05.00 -					
19.460 FALS E62	05.00 -					
19.460 FLK E61	05.00 -					
19.460 FLS E61	05.00 -					
26.310 FAVLC E66	05.00 -					
26.310 FAVLK E66	05.00 -					
26.360 FAVLC E66	05.00 -					
26.360 FAVLK E66	05.00 -					
26.410 DFARC E40	05.00 -					
26.410 DFRC, FAVLC E40,E66	05.00 -					
26.410 FAVLK E66	05.00 -					
26.460 DFARC E40	05.00 -					
26.460 DFLS, DFLRS E40	05.00 -					
26.460 FAVLC E66	05.00 -					
26.460 FAVLK E66	05.00 -					
28.230 FNLC E63	05.00 -					
28.310 FNLC E63	05.00 -					
28.360 FANLC E67	05.00 -					
28.360 FANLK E67	05.00 -					
28.360 FNALC E67	05.00 -					
28.360 FNALK E67	05.00 -					
28.360 FNLC E63	05.00 -					
28.410 FANLC E67	05.00 -					
28.410 FANLK E67	05.00 -					
28.410 FNALC E67	05.00 -					
28.410 FNALK E67	05.00 -					
28.410 FNLC E63	05.00 -					
28.460 FANLC E67	05.00 -					
28.460 FANLK E67	05.00 -					
28.460 FNALC E67	05.00 -					
28.460 FNALK E67	05.00 -					
28.460 FNLC E63	05.00 -					
30.310 FNLC E69	05.00 -					
30.360 FANLC E60	05.00 -					
30.360 FANLK E60	05.00 -					
30.360 FNLC E69	05.00 -					

Vehicle list



MAN































E 2000 05.00 -

30.410 FANLC E60	05.00 -		4028.10.00	400 MFZ2/400X	- GBox: ZF Ecosplit-3 - Vehicles with double disc clutch - This part number includes one clutch disc	
30.410 FANLK E60	05.00 -			4036.30.00	400 10 400 WGTZ	- GBox: ZF Ecosplit-3 - Vehicles with double disc clutch
30.410 FNLC E69	05.00 -				8941.40.00	KZISZ-5
30.460 FANLC E60	05.00 -					
30.460 FANLK E60	05.00 -					
30.460 FNLC E69	05.00 -					
32.310 VFCL E65	05.00 -					
32.310 VFNLC E65	05.00 -					
	05.00 -					
32.360 VFCL E65	05.00 -					
32.360 VFNLC E65	05.00 -					
	05.00 -					
32.410 VFARK E41	05.00 -					
32.410 VFCL, VFRC, VFRLC E65, E41	05.00 -					
32.410 VFNLC E65	05.00 -					
	05.00 -					
32.460 VFARK E41	05.00 -					
32.460 VFCL, VFRLC E65, E41	05.00 -					
32.460 VFNLC E65	05.00 -					
	05.00 -					
33.360 DFAK, DFALK E72, E60	05.00 -					
33.360 DFALC E60	05.00 -					
33.360 DFALS E60	04.01 -					
33.360 DFCL E69	05.00 -					
33.410 DFAK, DFALK E72, E60	05.00 -					
33.410 DFALC E60	05.00 -					
33.410 DFALS E60	04.01 -					
33.410 DFCL E69	05.00 -					
33.410 DFLK E69	05.00 -					
33.410 DFLS E69	05.00 -					
33.460 DFAK, DFALK E72, E60	05.00 -					
33.460 DFALC E60	05.00 -					
33.460 DFALS E60	04.01 -					
33.460 DFLK E69	05.00 -					
33.460 DFLS E69	05.00 -					
33.600 DFLS E99	06.00 -					
35.360 VFAK E68	05.00 -					
35.410 FVNLC E73	05.00 -					
	05.00 -					
35.410 VFAK E68	05.00 -					
35.460 FVNLC E73	05.00 -					
	05.00 -					
35.460 VFAK E68	05.00 -					
40.600 DFAS E94	06.00 -					
41.360 VFAK E68	05.00 -					
41.410 VFAK E68	05.00 -					
41.460 DFVS, DFVLS E75	06.00 -					
41.460 VFAK E68	05.00 -					
50.410 VFAK E68	05.00 -					
50.410 VFK E68	05.00 -					
50.460 VFAK E68	05.00 -					
50.460 VFK E68	05.00 -					

Vehicle list

			 RUEN	 Parameter	
---	---	---	--	--	---

MAN

F 2000		01.94 -				
11.153 T72	04.96 -		 3950.90.02	395 10		
11.163 T72	04.96 -		 3956.20.00	MFZ395		
12.153 T72,74,76	04.96 -		 3951.30.00	395WGTZ		
			 8535.40.00	KZIZ - 4,5		
			 3620.90.10	362 10		
			 3610.20.00	MFZ362		
			 3610.30.00	362GTZ		
13.153 T74,76	04.96 -		 3950.90.02	395 10		
13.163 T74,76	04.96 -		 3956.20.00	MFZ395		
14.153 T74,76,81,83	04.96 -		 3951.30.00	395WGTZ		
15.153 T81,83	04.96 -		 8535.40.00	KZIZ - 4,5		
15.163 T81,83	04.96 -		 3620.90.10	362 10		
			 3610.20.00	MFZ362		
			 3610.30.00	362GTZ		
32.323 T15	01.95 -		 4300.90.49	430 10		
35.293 T15	01.95 -		 4301.20.00	MFZ430		
35.323 T15,16	01.95 -		 4346.30.00	430WGTZ		
37.323 T16	01.95 -		 8916.40.00	KZIZ - 5		
37.343 T16	01.95 -					
41.323 T16	01.95 -					
18.373 T31,32			 4300.90.05	430 10		
18.403 T31,32			 4301.20.00	MFZ430		
18.423 T31,32			 4346.30.00	430WGTZ		
18.463 T31,32			 8916.40.00	KZIZ - 5		
19.404 T31,32			 4028.10.00	400		
19.463 T31,32				MFZ2/400X		
19.464 T31,32			 8941.40.00	KZISZ-5		
18.373 T33	01.94 -		 4300.90.05	430 10		
18.403 T33	01.94 -		 4301.20.00	MFZ430		
18.423 T33	01.94 -		 4346.30.00	430WGTZ		
18.463 T33	01.94 -		 8916.40.00	KZIZ - 5		
21.373 4x4 FA T34	08.94 -					
19.233 T31			 4028.10.00	400		
19.373 T31,32				MFZ2/400X		
19.403 T31,32			 8941.40.00	KZISZ-5		
19.423 T31,32						
26.464 T48						
33.463 T48	01.94 -					

Vehicle list

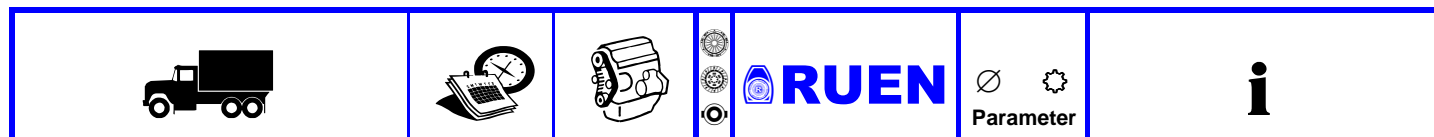

MAN

F 2000		01.94 -				
19.233 FCCNG T31	03.00 -	D 2866 LF20		4300.90.05	430 10	
19.403 FAC T34	01.94 -	D 2866 LF21		4301.20.00	MFZ430	
19.403 FAK FA-KI T34	01.94 -	D 2866 LF22		4346.30.00	430WGTZ	
19.403 FAS T34	01.94 -	E 2866 DF 01		8916.40.00	KZIZ - 5	
19.403 FC, FLC, FLLC, FRC, FLRC, F-NL T32, T33, T50, T31	01.94 -					
19.403 FK, F-KI, FK-L, FLK, FL-KI, F-NL T32, T31	01.94 -					
19.403 FS, FLS, FLLS, FRS, FLRS, FLLRS T32, T33, T50, T31	01.94 -					
19.423 FAC T34	01.94 - 12.95					
19.423 FAK,FA-KI T34	01.94 - 12.95					
19.423 FAS T34	01.94 - 12.95					
19.423 FC, FLC, FLLC, F-NL, T32, T33, T31	01.94 - 12.95					
19.423 FK, F-KI, FK-L, FLK, FL-KI, F-NL T32, T31	01.94 - 12.95					
19.423 FS, FLS, FLLS T32, T33, T31	01.94 - 12.95					
26.373 DFC,26.373 DFLC T40, T39	01.94 - 12.95					
26.373 DFK,26.373 DFLK T40, T39	01.94 - 12.95					
26.373 DFS,26.373 DFSL T40, T39	01.94 - 12.95					
26.373 FNLC,26.373 FNLLC,26.373 FVLC T37, T36, T38	01.94 - 12.95					
26.373 FNLS,26.373 FVLS T36, T38	01.94 - 12.95					
26.404 T39,40,42,48	01.94 -					
28.373 T48	01.94 -					
28.403 T48	01.94 -					
28.423 T48	01.94 -					
33.403 DFC T48	01.94 -					
33.403 DFK, DF-KI T48	01.94 -					
33.403 DFS, DFRS T48	01.94 -					
19.273 F,19.273 FL,19.273 FLLT01, T03, T02	01.94 - 12.95	D 2865 LF20		4300.90.49	430 10	
19.273 FA T04	01.94 - 12.95	D 2865 LF21		4301.20.00	MFZ430	
19.273 FAK T04	01.94 - 12.95	D 2865 LF22		4346.30.00	430WGTZ	
19.273 FK T01	01.94 - 12.95	D 2865 LF23		8916.40.00	KZIZ - 5	
19.273 FS,19.273 FLS T01, T02	01.94 - 12.95	D 2865 LF24		43460.30.00	430 10	- For PTO
19.293 FAC T04	01.94 -				430WGTZ	
19.293 FAK T04	01.94 -					
19.293 FAS T04	01.94 -					
19.293 FC,19.293 FLC,19.293 FLLC T01, T03, T20, T02	01.94 -					
19.293 FK,19.293 FLK T01, T02	01.94 -					
19.293 FS,19.293 FLS,19.293 FLLS T01, T03, T20, T02	01.94 -					
19.323 FC,19.323 FLC,19.323 FLLC T01, T03, T02	01.94 - 12.95					
19.323 FS,19.323 FLS,19.323 FLLS T01, T03, T02	01.94 - 12.95					
19.343 FAC T04	01.94 -					
19.343 FAK T04	01.94 -					
19.343 FAS T04	01.94 -					
19.343 FC,19.343 FLC,19.343 FLLC T01, T03, T20, T02	01.94 -					
19.343 FK,19.343 FLK T01, T02	01.94 -					
19.343 FS,19.343 FLS,19.343 FLLS T01, T03, T20, T02	01.94 -					



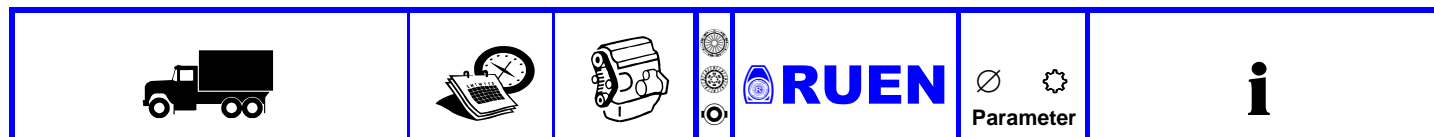



Vehicle list

















































































MAN

F 2000		01.94 -				
19.314 FAS T34	06.98 -	D 2866 LF31		4300.90.05	430 10	
19.314 FC, FLC, FLLC, FLLW, FRC, FLRC, FLLRC, FLL, FLLR, F-N T32, T33, T50, T31	06.98 -	D 2866 LF34		4301.20.00	MFZ430	
19.314 FK, FK-L, F-KI, FL-KI, F-NL, FLK T31, T32	06.98 -	D 2866 LF35		4346.30.00	430WGTZ	
19.314 FS, FLS, FLLS, FRS, FLRS, FLLRS T33, T31, T32, T50	06.98 -			8916.40.00	KZIZ - 5	
19.364 FAC T34	06.98 -					
19.364 FAK, FA-KI, FAK-L T34	06.98 -					
19.364 FAS T34	06.98 -					
19.364 FC, FLC, FLLC, FLLW, FRC, FLRC, FLLRC, FLL, FLLR, F-N T32, T33, T50, T31	06.98 -					
19.364 FK, FK-L, F-KI, FL-KI, F-NL, FLK T32, T31	06.98 -					
19.364 FS, FLS, FLLS, FRS, FLRS, FLLRS T32, T33, T50, T31	06.98 -					
19.414 FAC T34	06.98 -					
19.414 FAK, FA-KI, FAK-L T34	06.98 -					
19.414 FAS T34	06.98 -					
19.414 FC, FLC, FLLC, FRC, FLRC, FLLRC, FLL, FLLR, F-NL T32, T33, T50, T31	06.98 -					
19.414 FK, F-KI, FK-L, FLK, FL-KI, F-NL T31, T32	06.98 -					
19.414 FS, FLS, FLLS, FRS, FLRS, FLLRS T32, T33, T50, T31	06.98 -					
26.413 T36						
26.414						
19.323 FAC T04	01.94 - 12.95	D 2865 LF23		4300.90.49	430 10	
19.323 FAK T04	01.94 - 12.95			4301.20.00	MFZ430	
19.323 FAS T04	01.94 - 12.95			4346.30.00	430WGTZ	
				8916.40.00	KZIZ - 5	
19.344 T04,20,E52	01.94 -			4300.90.49	430 10	
21.343 T04	01.94 -			4301.20.00	MFZ430	
23.344 T05	04.94 -			4346.30.00	430WGTZ	
24.343 T05,06,E53	01.94 -			8916.40.00	KZIZ - 5	
28.343 T08	01.94 -					
19.373 FAC T34	01.94 - 12.95	D 2866 LF21		4300.90.05	430 10	
19.373 FAK, FA-KI, FAK-L T34	01.94 - 12.95			4301.20.00	MFZ430	
19.373 FAS T34	01.94 - 12.95			4346.30.00	430WGTZ	
19.373 FC, FLC, FLLC, FRC, FLRC, F-NL T32, T33, T31	01.94 - 12.95			8916.40.00	KZIZ - 5	
19.373 FK, FK-L, F-KI, FL-KI, F-NL, FLK T32, T31	01.94 - 12.95			4305.30.00	430 10	430W2GTZ
19.373 FS, FLS, FLLS, FRS, FLRS, FLLRS T32, T33, T31	01.94 - 12.95					
19.404 T34,E61,62	01.94 -	D 2866 LF20		4300.90.05	430 10	
23.404 T35,37	01.94 -			4301.20.00	MFZ430	
24.403 T35,37	01.94 -			4346.30.00	430WGTZ	
24.403 FNLLC T37	01.94 -			8916.40.00	KZIZ - 5	
25.403 T37	01.94 -			4305.30.00	430 10	430W2GTZ
26.403 DFC,26.403 DFLC T40, T39	01.94 -					
26.403 DFK,26.403 DFLK T40, T39	01.94 -					
26.403 DFS,26.403 DFLS T40, T39	01.94 -					
26.403 FNLC,26.403 FNLLC,26.403 FVLC T37, T36, T38	01.94 -					
26.403 FNLS,26.403 FVLS T36, T38	01.94 -					







Vehicle list

					
---	---	---	--	---	---





























MAN

F 2000		01.94 -				
19.404 T50				4300.90.05   	430 10 MFZ430 430WGTZ KZIZ - 5	- From model year: 01.1995 - To model year: 05.1996
				4300.90.49   	430 10 MFZ430 430WGTZ KZIZ - 5	- From model year: 06.1996
19.463 FAC T34	01.94 -	D 2876 LF 02		4300.90.05   	430 10 MFZ430 430WGTZ KZIZ - 5	
19.463 FAK, FA-KI, FAK-L T34	01.94 -			  		
19.463 FAS T34	01.94 -			 		
19.463 FC, FLC, FLLC, FRC, FLRC, F-NL T32, T33, T50, T31	01.94 -			 		
19.463 FK, F-KI, FK-L, FLK, FL-KI, F-NL T32, T31	01.94 -			 		
19.463 FS, FLS, FLLS, FRS, FLRS, FLLRS T32, T33, T50, T31	01.94 -			 		
19.464 T34,E61,62	01.94 -			4300.90.05   	430 10 MFZ430 430WGTZ KZIZ - 5	
21.403 4x4 FA T34	08.94 -			  		
19.464 T50				4300.90.05   	430 10 MFZ430 430WGTZ KZIZ - 5	- From model year: 01.1995 - To model year: 05.1996
				4300.90.49   	430 10 MFZ430 430WGTZ KZIZ - 5	- From model year: 06.1996
19.464 FAK, FA-KI, FAK-L, T34	06.98 -	D 2876 LF 02		4300.90.05   	430 10 MFZ430 430WGTZ KZIZ - 5	
19.464 FAS T34	06.98 -	D 2876 LF 06		  		
19.464 FC 19.464 FC, FLC, FLLC, FLL, FRC, FLLR, FLLRC, FLLW, F-NL T32, T33, T50, T31	06.98 -	E 2866 DF 01		 		
19.464 FK, F-KI, FK-L, FLK, FL-KI, F-NL T31, T32	06.98 -			 		
19.464 FS, FLS, FLLS, FRS, FLRS, FLLRS T32, T33, T50, T31	06.98 -			 		
26.233 FVLCNG T38	09.96 -			 		
26.463 DFC,26.463 DFLC T40, T39	01.94 -			 		
26.463 DFK,26.463 DFLK T40, T39	01.94 -			 		
26.463 DFS,26.463 DFLS T40, T39	01.94 -			 		
26.463 FNLC, FNLLC, FNLLRC, FNLLW, FNLR, FNLLRC, FVLC T37, T36, T38	01.94 -			 		
26.463 FNLS,FVLS, FVLRS T36, T38	01.94 -			 		
19.603 FLS T62	04.96 -	D 2840 LF20		4028.10.00	400 MFZ2/400X	
				8941.40.00	KZISZ-5	
21.273 T04	01.94 -			4300.90.49   	430 10 MFZ430 430WGTZ KZIZ - 5	
26.273 T06-10,12,E53,69	01.94 -			  		
21.293 T04	01.94 -			4300.90.49   	430 10 MFZ430 430WGTZ KZIZ - 5	
33.293 T12	01.94 -			  		

Vehicle list

					
---	---	---	--	---	---

MAN

F 2000		01.94 -				
21.323 T04 26.323 T06-10,12,E53 33.323 T12	01.94 - 01.94 - 01.94 -			 4300.90.49  4301.20.00  4346.30.00  8916.40.00	430 10 MFZ430 430WGTZ KZIZ - 5	
21.423 4x4 FA T34	08.94 -			 4300.90.05  4301.20.00  4346.30.00  8916.40.00	430 10 MFZ430 430WGTZ KZIZ - 5	
21.463 4x4 FA T34	08.94 -			 4300.90.05  4301.20.00  4346.30.00  8916.40.00	430 10 MFZ430 430WGTZ KZIZ - 5	
23.273 T05 24.273 T05,06,E53	04.94 - 01.94 -			 4300.90.49  4301.20.00  4346.30.00  8916.40.00	430 10 MFZ430 430WGTZ KZIZ - 5	
23.293 FNLLC T05	01.94 -	D 2865 LF20 D 2865 LF24		 4300.90.49  4301.20.00  4346.30.00  8916.40.00	430 10 MFZ430 430WGTZ KZIZ - 5	
23.323 T05 24.323 T05,06,E53 28.323 T08	04.94 - 01.94 - 01.94 -			 4300.90.49  4301.20.00  4346.30.00  8916.40.00	430 10 MFZ430 430WGTZ KZIZ - 5	
23.343 FNLLC T05 24.273 FNLLC T07 24.293 FNLLC T07 24.323 FNLLC T07 24.343 FNLLC T07 26.273 DFC,26.273 DFLC T10, T09 26.273 DFK,26.273 DFLK T10, T09 26.273 DFS,26.273 DFLS T10, T09 26.273 FNLC,26.273 FNLLC,26.273 FVLC T08, T07, T06 26.273 FNLS,26.273 FVLS T08, T06 26.323 DFC,26.323 DFLC T10, T09 26.323 DFK,26.323 DFLK T10, T09 26.323 DFS,26.323 DFLS T10, T09 26.323 FNLC,26.323 FNLLC,26.323 FVLC T07, T08, T06 26.323 FNLS,26.323 FVLS T08, T06 27.273 DFC T18 27.273 DFK T18 27.273 DFS T18 27.323 DFC T18 27.323 DFK T18 27.323 DFS T18 27.343 DFC T18 27.343 DFK T18 27.343 DFS T18	01.94 - 01.94 - 12.95 01.94 - 01.94 - 12.95 01.94 - 01.94 - 12.95 01.94 - 12.95 01.94 - 12.95 01.94 - 12.95 01.94 - 12.95 01.94 - 12.95 01.94 - 12.95 01.94 - 12.95 01.94 - 12.95 01.94 - 12.95 01.94 - 12.95 01.94 - 12.95 01.94 - 12.95 01.94 - 01.94 - 12.95 01.94 - 12.95 01.94 - 12.95 01.94 - 12.95 01.94 - 12.95 01.94 - 01.94 - 01.94 -	D 2865 LF21 D 2865 LF22 D 2865 LF23 D 2865 LF24		 4300.90.49  4301.20.00  4346.30.00  8916.40.00	430 10 MFZ430 430WGTZ KZIZ - 5	

Vehicle list



MAN





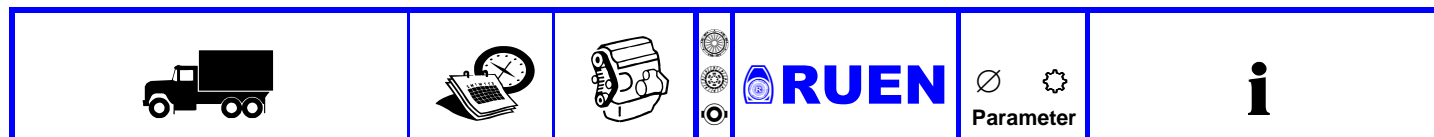

F 2000		01.94 -				
23.373 T35,37	01.94 -	D 2866 LF20		4300.90.05	430 10	
23.403 FNLLC T35	01.94 -	D 2866 LF21		4301.20.00	MFZ430	
23.463 FNLLC T35	01.94 -	D 2866 LF22		4346.30.00	430WGTZ	
24.373 FNLLC T37	01.94 - 12.95	D 2876 LF 02		8916.40.00	KZIZ - 5	
26.423 FNLC,26.423 FNLLC,26.423 FVLCT 37, T36, T38	01.94 - 12.95					
26.423 FNLS,26.423 FVLS T36, T38	01.94 - 12.95					
23.423 T35,37	01.94 -	D 2866 LF20		4300.90.05	430 10	
24.403 FNLLC T37	01.94 -			4301.20.00	MFZ430	
24.423 T35,37	01.94 -			4346.30.00	430WGTZ	
				8916.40.00	KZIZ - 5	
23.464 T35,37	01.94 -	D 2876 LF 02		4300.90.05	430 10	
24.463 T35,37	01.94 -			4301.20.00	MFZ430	
24.463 FNLLC T37	01.94 -			4346.30.00	430WGTZ	
				8916.40.00	KZIZ - 5	
24.293 T05,06,E53	01.94 -			4300.90.49	430 10	
28.293 T08	01.94 -			4301.20.00	MFZ430	
				4346.30.00	430WGTZ	
				8916.40.00	KZIZ - 5	
26.293 DFC,26.293 DFLC T10, T09	01.94 -	D 2865 LF20		4300.90.49	430 10	
26.293 DFK,26.293 DFLK T10, T09	01.94 -	D 2865 LF24		4301.20.00	MFZ430	
26.293 DFS,26.293 DFLS T10, T09	01.94 -			4346.30.00	430WGTZ	
26.293 FNLC,26.293 FNLLC,26.293 FVLC T08, T07, T06	01.94 -			8916.40.00	KZIZ - 5	
26.293 FNLS,26.293 FVLS T08, T06	01.94 -					
26.343 DFC,26.343 DFLC T10, T09	01.94 -	D 2865 LF21		4300.90.49	430 10	
26.343 DFK,26.343 DFLK T10, T09	01.94 -			4301.20.00	MFZ430	
26.343 DFS,26.343 DFLS T10, T09	01.94 -			4346.30.00	430WGTZ	
26.343 FNLC,26.343 FNLLC,26.343 FVLC T08, T07, T06	01.94 -			8916.40.00	KZIZ - 5	
26.343 FNLS,26.343 FVLS T08, T06	01.94 -					
26.423 DFC,26.423 DFLC T40, T39	01.94 - 12.95	D 2866 LF21		4300.90.05	430 10	
26.423 DFK,26.423 DFLK T40, T39	01.94 - 12.95	D 2866 LF22		4301.20.00	MFZ430	
26.423 DFS,26.423 DFLST 40, T39	01.94 - 12.95			4346.30.00	430WGTZ	
27.373 DFC T48	01.94 - 12.95			8916.40.00	KZIZ - 5	
27.373 DFK, DFK-KI, DFK-L, DF-KI T48	01.94 - 12.95					
27.373 DFS T48	01.94 - 12.95					
27.423 DFC T48	01.94 - 12.95					
27.423 DFK, DFK-KI, DFK-L, DF-KI T48	01.94 - 12.95					
27.423 DFS T48	01.94 - 12.95					
26.463 T48				4300.90.05	430 10	- Engine code: D 2876
				4301.20.00	MFZ430	
				4346.30.00	430WGTZ	
				8916.40.00	KZIZ - 5	
				4028.10.00	400	- Engine code: D 2840
					MFZ2/400X	
				8941.40.00	KZISZ-5	- Engine code: D 2840
26.464 T39,40,48	01.94 -	D 2876 LF 02		4300.90.05	430 10	
27.463 DFK, DFK-KI, DFK-L, DF-KI T48	01.94 -			4301.20.00	MFZ430	
27.463 DFS T48	01.94 -			4346.30.00	430WGTZ	
33.463 DFC T48	01.94 -			8916.40.00	KZIZ - 5	
33.463 DFK, DF-KI T48	01.94 -					
33.463 DFS, DFRS T48	01.94 -					
26.603 DFC,26.603 DFLC T78, T70	06.96 -	D 2840 LF20		4028.10.00	400	
26.603 DFK,26.603 DFLK T78, T70	06.96 -				MFZ2/400X	
26.603 DFS,26.603 DFLS T78, T70	06.96 -			8941.40.00	KZISZ-5	

Vehicle list





















































MAN						
F 2000						
01.94 -						
27.293 DFC T18 27.293 DFK T18 27.293 DFS T18	01.94 - 01.94 - 01.94 -	D 2865 LF20 D 2865 LF24		4300.90.49 4301.20.00 4346.30.00 8916.40.00	430 10 MFZ430 430WGTZ KZIZ - 5	
27.293 DFAC T12 27.293 DFAK T12 27.293 DFAS T12	01.94 - 01.94 - 01.94 -	D 2865 LF20 D 2865 LF24		4300.90.49 4301.20.00 4346.30.00 8916.40.00	430 10 MFZ430 430WGTZ KZIZ - 5	
27.323 DFAC T12 27.323 DFAK T12 27.323 DFAS T12	01.94 - 12.95 01.94 - 12.95 01.94 - 12.95	D 2865 LF23		4300.90.49 4301.20.00 4346.30.00 8916.40.00	430 10 MFZ430 430WGTZ KZIZ - 5	
27.343 DFAC T12 27.343 DFAK T12 27.343 DFAS T12	01.94 - 01.94 - 01.94 -	D 2865 LF21		4300.90.49 4301.20.00 4346.30.00 8916.40.00	430 10 MFZ430 430WGTZ KZIZ - 5	
27.373 DFAC T42 27.373 DFAK, DFA-KI, DFAK-L T42 27.373 DFAS T42 27.403 DFAC T42 27.403 DFAK,DFA-KI, DFAK-L T42 27.403 DFAS T42 27.423 DFAC T42 27.423 DFAK, DFA-KI, DFAK-L T42 27.423 DFAS T42	01.94 - 12.95 01.94 - 12.95 01.94 - 12.95 01.94 - 01.94 - 01.94 - 01.94 - 12.95 01.94 - 12.95 01.94 - 12.95	D 2866 LF20 D 2866 LF21 D 2866 LF22		4300.90.05 4301.20.00 4346.30.00 8916.40.00	430 10 MFZ430 430WGTZ KZIZ - 5	
27.402 T39,40,42	01.94 -			4300.90.05 4301.20.00 4346.30.00 8916.40.00	430 10 MFZ430 430WGTZ KZIZ - 5	
27.403 DFC T48 27.403 DFK,DFK-KI, DFK-L, DF-KI T48 27.403 DFS T48	01.94 - 01.94 - 01.94 -	D 2866 LF20		4300.90.05 4301.20.00 4346.30.00 8916.40.00	430 10 MFZ430 430WGTZ KZIZ - 5	
27.463 DFAC T42 27.463 DFAK, DFA-KI, DFAK-L T42 27.463 DFAS T42 33.463 DFAC T42 33.463 DFAK, DFAK-HK, DFA-KI T42 33.463 DFAS T42	01.94 - 01.94 - 01.94 - 01.94 - 01.94 - 01.94 -	D 2876 LF 02		4300.90.05 4301.20.00 4346.30.00 8916.40.00	430 10 MFZ430 430WGTZ KZIZ - 5	
27.463 DFC T48 28.463 T48 38.463 T48	01.94 - 01.94 -	D 2876 LF 02		4300.90.05 4301.20.00 4346.30.00 8916.40.00	430 10 MFZ430 430WGTZ KZIZ - 5	- Engine code: D 2876
				4028.10.00	400 MFZ2/400X	- Engine code: D 2840
				8941.40.00	KZISZ-5	- Engine code: D 2840
27.603 DFAS T72 27.603 DFS T78 33.603 DFAC T72 33.603 DFAS T72 33.603 DFC T78 33.603 DFS, DFRS T78	01.96 - 01.96 - 06.96 - 06.96 - 06.96 - 06.96 -	D 2840 LF20		4028.10.00 	400 MFZ2/400X	
				8941.40.00	KZISZ-5	

Vehicle list

					
---	---	---	--	---	---









































MAN

F 2000		01.94 -				
28.273 T08	01.94 -		 4300.90.49  4301.20.00  4346.30.00  8916.40.00	430 10 MFZ430 430WGTZ KZIZ - 5		
28.603 T70,78	01.96 -		 4028.10.00  8941.40.00	400 MFZ2/400X KZISZ-5		
32.293 VFC T15 32.343 VFC T15	08.95 - 08.95 -	D 2865 LF21 D 2865 LF24	 4300.90.49  4301.20.00  4346.30.00  8916.40.00	430 10 MFZ430 430WGTZ KZIZ - 5		
32.343 VFK T15	08.95 -	D 2865 LF21	 4300.90.49  4301.20.00  4346.30.00  8916.40.00	430 10 MFZ430 430WGTZ KZIZ - 5		
32.373 T45,46 35.373 T45,46 37.373 T45,46	01.94 - 01.94 - 01.94 -		 4300.90.05  4301.20.00  4346.30.00  8916.40.00	430 10 MFZ430 430WGTZ KZIZ - 5	- To model year: 05.1996	
			 4300.90.49  4301.20.00  4346.30.00  8916.40.00	430 10 MFZ430 430WGTZ KZIZ - 5	- From model year: 06.1996	
32.403 VFC T45 32.403 VFK T45	08.95 - 08.95 -	D 2866 LF20	 4300.90.05  4301.20.00  4346.30.00  8916.40.00	430 10 MFZ430 430WGTZ KZIZ - 5		
32.423 T45,46 35.423 T45,46 37.423 T45,46 41.423 T45,46	01.94 - 01.94 - 01.94 - 01.94 -		 4300.90.05  4301.20.00  4346.30.00  8916.40.00	430 10 MFZ430 430WGTZ KZIZ - 5	- To model year: 05.1996	
			 4300.90.49  4301.20.00  4346.30.00  8916.40.00	430 10 MFZ430 430WGTZ KZIZ - 5	- From model year: 06.1996	
32.463 VFC T45 32.463 VFK T45	08.95 - 08.95 -	D 2876 LF 02	 4300.90.05  4301.20.00  4346.30.00  8916.40.00	430 10 MFZ430 430WGTZ KZIZ - 5		
33.273 T12,E69	01.94 -		 4300.90.49  4301.20.00  4346.30.00  8916.40.00	430 10 MFZ430 430WGTZ KZIZ - 5		
33.323 DFC T18 33.323 DFK T18 33.323 DFS T18 33.343 DFC T18 33.343 DFK T18 33.343 DFS T18	01.94 - 12.95 01.94 - 12.95 01.94 - 12.95 01.94 - 01.94 - 01.94 -	D 2865 LF21 D 2865 LF23	 4300.90.49  4301.20.00  4346.30.00  8916.40.00	430 10 MFZ430 430WGTZ KZIZ - 5		
33.323 DFAC T12 33.323 DFAK T12 33.323 DFAS T12	01.94 - 12.95 01.94 - 12.95 01.94 - 12.95	D 2865 LF23	 4300.90.49  4301.20.00  4346.30.00  8916.40.00	430 10 MFZ430 430WGTZ KZIZ - 5		

Vehicle list

					
---	---	---	--	---	---

MAN





































F 2000		01.94 -				
33.343 DFAC T12	01.94 -	D 2865 LF21		4300.90.49	430 10	
33.343 DFAK T12	01.94 -			 4301.20.00	MFZ430	
33.343 DFAS T12	01.94 -			 4346.30.00	430WGTZ	
				 8916.40.00	KZIZ - 5	
33.373 DFC T48	01.94 - 12.95	D 2866 LF21		4300.90.05	430 10	
33.373 DFK, DF-KI T48	01.94 - 12.95			 4301.20.00	MFZ430	
33.373 DFS, DFRS T48	01.94 - 12.95			 4346.30.00	430WGTZ	
				 8916.40.00	KZIZ - 5	
33.373 DFAC T42	01.94 - 12.95	D 2866 LF21		4300.90.05	430 10	
33.373 DFAK, DFAK-HK, DFA-KI T42	01.94 - 12.95			 4301.20.00	MFZ430	
33.373 DFAS T42	01.94 - 12.95			 4346.30.00	430WGTZ	
				 8916.40.00	KZIZ - 5	
33.403 DFAC T42	01.94 -	D 2866 LF20		4300.90.05	430 10	
33.403 DFAK, DFAK-HK, DFA-KI T42	01.94 -			 4301.20.00	MFZ430	
33.403 DFAS T42	01.94 -			 4346.30.00	430WGTZ	
				 8916.40.00	KZIZ - 5	
33.423 DFC T48	01.94 - 12.95	D 2866 LF22		4300.90.05	430 10	
33.423 DFK, DF-KI T48	01.94 - 12.95			 4301.20.00	MFZ430	
33.423 DFS, DFRS T48	01.94 - 12.95			 4346.30.00	430WGTZ	
				 8916.40.00	KZIZ - 5	
33.423 DFAC T42	01.94 - 12.95	D 2866 LF22		4300.90.05	430 10	
33.423 DFAK, DFAK-HK, DFA-KI T42	01.94 - 12.95			 4301.20.00	MFZ430	
33.423 DFAS T42	01.94 - 12.95			 4346.30.00	430WGTZ	
				 8916.40.00	KZIZ - 5	
35.314 VF (FE310A) T46	06.98 -	D 2866 LF20		4300.90.05	430 10	
35.364 VF. (FE360A) T46	06.98 -	D 2866 LF31		 4301.20.00	MFZ430	
35.403 VF, VFC, VFRC T46	08.95 -	D 2866 LF34		 4346.30.00	430WGTZ	
35.403 VFK, VF-HK, VF-KI T46	08.95 -	D 2866 LF35		 8916.40.00	KZIZ - 5	
35.414 VF. (FE410A) T46	06.98 -	D 2876 LF 02		4028.10.00	400	
35.463 VFC T46	08.95 -				MFZ2/400X	
35.463 VFK T46	08.95 -			8941.40.00	KZISZ-5	
41.364 VF. (FE360A) T46	06.98 -					
41.403 VF, VFC, VFRC T46	08.95 -					
41.403 VFK, VF-HK, VF-KI T46	08.95 -					
41.414 VF. (FE410A) T46	06.98 -					
41.463 VF, VFC, VFRC T46	08.95 -					
41.463 VFK, VF-HK, VF-KI T46	08.95 -					
35.364 VFAK E68		D 2866 LF24		4300.90.05	430 10	
35.414 VFAK E68		D 2866 LF25		 4301.20.00	MFZ430	
35.464 VF. (FE460A) T46	06.98 -	D 2876 LF 03		 4346.30.00	430WGTZ	
35.464 VFAK E68				 8916.40.00	KZIZ - 5	
41.364 VFAK E68				4028.10.00	400	
41.414 VFAK E68					MFZ2/400X	
41.464 VFAK E68				8941.40.00	KZISZ-5	
50.414 VFK/VFAK E68						
50.464 VFK/VFAK E68						
35.343 VFC T16	08.95 -	D 2865 LF21		4300.90.49	430 10	
35.343 VFK T16	08.95 -			 4301.20.00	MFZ430	
				 4346.30.00	430WGTZ	
				 8916.40.00	KZIZ - 5	

Vehicle list

					
---	---	---	--	---	---

MAN

F 2000 01.94 -

37.403 T45,46			 4300.90.05  4301.20.00  4346.30.00  8916.40.00	430 10 MFZ430 430WGTZ KZIZ - 5	- From model year: 01.1994 - To model year: 05.1996
			 4300.90.49  4301.20.00  4346.30.00  8916.40.00	430 10 MFZ430 430WGTZ KZIZ - 5	- From model year: 06.1996
37.463 T45,46			 4300.90.05  4301.20.00  4346.30.00  8916.40.00	430 10 MFZ430 430WGTZ KZIZ - 5	- From model year: 01.1994 - To model year: 05.1996
			 4300.90.49  4301.20.00  4346.30.00  8916.40.00	430 10 MFZ430 430WGTZ KZIZ - 5	- From model year: 06.1996
40.373 T43 40.403 T43 40.423 T43 40.463 T43			 4028.10.00	400 MFZ2/400X	
			 8941.40.00	KZISZ-5	
40.463		D 2876 LF01	 4300.90.05  4301.20.00  4346.30.00  8916.40.00	430 10 MFZ430 430WGTZ KZIZ - 5	
41.343 VFC T16 41.343 VFK T16	08.95 - 08.95 -	D 2865 LF21	 4300.90.49  4301.20.00  4346.30.00  8916.40.00	430 10 MFZ430 430WGTZ KZIZ - 5	
41.373 T45,46	01.94 -		 4300.90.05  4301.20.00  4346.30.00  8916.40.00	430 10 MFZ430 430WGTZ KZIZ - 5	
41.464 VF. (FE460A) T46	06.98 -	D 2876 LF 03	 4300.90.05  4301.20.00  4346.30.00  8916.40.00	430 10 MFZ430 430WGTZ KZIZ - 5	
			 4028.10.00	400 MFZ2/400X	
			 8941.40.00	KZISZ-5	

Vehicle list



MAN

F 2000 01.94 -

Vehicle Model	Configuration	Part Number	Price	Clutch Type	Notes
19.233 4x2 F/FR T31		D 2866 LF23	4028.10.00	400 MFZ2/400X	- GBox: ZF Ecosplit-3 - Vehicles with double disc clutch
19.233 FK, FK-L, CNG T31	03.00 -	D 2866 LF24			
23.314 FNLLC T35	05.01 -	D 2866 LF25	4036.30.00	400 10 400 WGTZ	- GBox: ZF Ecosplit-3 - Vehicles with double disc clutch
23.314 FNLLC T35	05.01 -	E 2866 DF 01	8941.40.00	KZISZ-5	- GBox: ZF Ecosplit-3 - Vehicles with double disc clutch
23.364 FNLLC T35	05.01 -				
23.414 FNLLC T35	05.01 -				
23.464 FNLLC T35	05.01 -				
24.314 FNLLRC T37	05.01 -				
24.364 FNLLRC T37	05.01 -				
24.414 FNLLRC T37	05.01 -				
24.464 FNLLRC T37	05.01 -				
26.233 FVL-KO T38	03.00 -				
26.314 DFC, DFLC T40, T39	05.01 -				
26.314 DFK, DFLK, DFLK-L T40, T39	05.01 -				
26.314 DFS, DFLS T40, T39	05.01 -				
26.314 DF-TM T39	05.01 -				
26.314 FNLC, FNLLC, FNLLRC, FNLLW, FNLRC, FNLLRC, FVLC T37, T36, T38	05.01 -				
26.314 FNLS T36	05.01 -				
26.314 FVL-KO T38	05.01 -				
26.314 FVLS, FVLRS T38	05.01 -				
26.364 DFC, DFLC T40, T39	05.01 -				
26.364 DFK, DFLK, DFLK-L T40, T39	05.01 -				
26.364 DFS, DFLS T40, T39	05.01 -				
26.364 DF-TM T39	05.01 -				
26.364 FNLC, FNLLC, FNLLRC, FNLLW, FNLRC, FNLLRC, FVLC T37, T36, T38	05.01 -				
26.364 FNLS T36	05.01 -				
26.364 FVL-KO T38	05.01 -				
26.364 FVLS, FVLRS T38	05.01 -				
26.414 DFC, DFLC T40, T39	05.01 -				
26.414 DFK, DFLK, DFLK-L T40, T39	05.01 -				
26.414 DFS, DFLS T40, T39	05.01 -				
26.414 DF-TM	05.01 -				
26.414 FNLC, FNLLC, FNLLRC, FNLLW, FNLRC, FNLLRC, FVLC T37, T36, T38	05.01 -				
26.414 FNLS T36	05.01 -				
26.414 FVL-KO T38	05.01 -				
26.414 FVLS, FVLRS T38	05.01 -				

Vehicle list



MAN

F 2000

01.94 -

26.464 DFC, DFLC T40, T39	05.01 -	D 2866 LF23		4028.10.00	400 MFZ2/400X	- GBox: ZF Ecosplit-3 - Vehicles with double disc clutch
26.464 DFK, DFLK, DFLK-L T40, T39	05.01 -	D 2866 LF24				
26.464 DFS, DFLS T40, T39	05.01 -	D 2866 LF25		4036.30.00	400 10 400 WGTZ	- GBox: ZF Ecosplit-3 - Vehicles with double disc clutch
26.464 DF-TM T39	05.01 -	D 2866 LUH26				
26.464 FNLC, FNLLC, FNLLRC, FNLLW, FNLRC, FNLLRC, FVLC T37, T36, T38	05.01 -	D 2876 LF 03		8941.40.00	KZISZ-5	- GBox: ZF Ecosplit-3 - Vehicles with double disc clutch
26.464 FNLS T36	05.01 -					
26.464 FVL-KO T38	05.01 -					
26.464 FVLS, FVLR T38	05.01 -					
27.314 DFAC T42	05.01 -					
27.314 DFAK, DFA-KI, DFAK-L T42	05.01 -					
27.314 DFAS T42	05.01 -					
27.314 DFC T48	05.01 -					
27.314 DFK, DFLK, DFLK-L, DF-KI T48	05.01 -					
27.314 DFS T48	05.01 -					
27.314 DF-TM T48	05.01 -					
27.314 FVL T38	06.98 -					
27.364 DFAC T42	05.01 -					
27.364 DFAK, DFA-KI, DFAK-L T42	05.01 -					
27.364 DFAS T42	05.01 -					
27.364 DFC T48	05.01 -					
27.364 DFK, DFK-KI, DFK-L, DF-KI T48	05.01 -					
27.364 DFS T48	05.01 -					
27.364 DF-TM T48	05.01 -					
27.364 FVL T38	06.98 -					
27.373 DF, 27.373 DFL T40, T39	01.94 -					
27.373 DF-TM T48	07.00 -					
27.403 DF, 27.403 DFL	01.94 -					
27.403 DF-TM T48	07.00 -					
27.414 DFAC T42	05.01 -					
27.414 DFAK, DFA-KI, DFAK-L T42	05.01 -					
27.414 DFAS T42	05.01 -					
27.414 DFC T48	05.01 -					
27.414 DFK, DFK-KI, DFK-L, DF-KI T48	05.01 -					
27.414 DFS T48	05.01 -					
27.414 DF-TM T48	05.01 -					
27.414 FVL T38	06.98 -					
27.423 DF, 27.423 DFL T40, T39	01.94 -					
27.423 DF-TM T48	07.00 -					
27.463 DF, 27.463 DFL T40, T39	01.94 -					
27.463 DF-TM T48	07.00 -					

Vehicle list



MAN

F 2000 01.94 -

27.464 DFC T48	01.94 -	D 2866 LF23	4028.10.00	400 MFZ2/400X	- GBox: ZF Ecosplit-3 - Vehicles with double disc clutch
27.464 DFK, DFK-KI, DFK-L, DF-KI T48	05.01 -	D 2866 LF24			
27.464 DFS T48	01.94 -	D 2866 LF25	4036.30.00	400 10 400 WGTZ	- GBox: ZF Ecosplit-3 - Vehicles with double disc clutch
27.464 DF-TM T48	05.01 -	D 2876 LF 03			
27.464 FVL T38	06.98 -	D 2876 LF 06	8941.40.00	KZISZ-5	- GBox: ZF Ecosplit-3 - Vehicles with double disc clutch
32.314 VF, VFC T45	05.01 -				
32.314 VFK, VF-HK T45	05.01 -				
32.314 VF-TM T45	05.01 -				
32.364 VFK, VF-HK T45	05.01 -				
32.364 VF-TM T45	05.01 -				
32.414 VF, VFC T45	05.01 -				
32.414 VFK, VF-HK T45	05.01 -				
32.414 VF-TM T45	05.01 -				
32.464 VF, VFC T45	05.01 -				
32.464 VFK, VF-HK T45	05.01 -				
32.464 VF-TM T45	05.01 -				
33.364 DFAC T42	05.01 -				
33.364 DFAK, DFAK-HK, DFA-KI T42	05.01 -				
33.364 DFAS T42	05.01 -				
33.364 DFC T48	05.01 -				
33.364 DFK, DF-KI T48	05.01 -				
33.364 DFS, DFRS T48	05.01 -				
33.414 DFAC T42	05.01 -				
33.414 DFAK, DFAK-HK, DFA-KI T42	05.01 -				
33.414 DFAS T42	05.01 -				
33.414 DFC T48	05.01 -				
33.414 DFK, DF-KI T48	05.01 -				
33.414 DFS, DFRS T48	05.01 -				
33.464 DFC T48	05.01 -				
33.464 DFK, DF-KI T48	05.01 -				
33.464 DFS, DFRS T48	05.01 -				
35.314 VF-TM T46	03.02 -				
35.364 VF, VFC, VFRC T46	05.01 -				
35.364 VFK, VF-HK, VF-KI T46	03.02 -				
35.364 VF-TM T46	03.02 -				
35.373 VF, VFC, VFRC T46	05.01 -				
35.373 VFK, VF-HK, VF-KI T46	03.02 -				
35.414 VF, VFC, VFRC T46	05.01 -				
35.414 VFK, VF-HK, VF-KI T46	03.02 -				
35.414 VF-TM T46	03.02 -				
35.423 VF, VFC, VFRC T46	05.01 -				
35.423 VFK, VF-HK, VF-KI T46	03.02 -				

Vehicle list



MAN

F 2000

01.94 -

35.464 VF, VFC, VFRC T46	05.01 -	D 2865 LF22		4028.10.00	400 MFZ2/400X	- GBox: ZF Ecosplit-3 - Vehicles with double disc clutch
35.464 VFK, VF-HK, VF-KI T46	03.02 -	D 2866 LF20				
35.464 VF-TM T46	03.02 -	D 2866 LF25		4036.30.00	400 10 400 WGTZ	- GBox: ZF Ecosplit-3 - Vehicles with double disc clutch
37.414 VFA E68	06.98 -	D 2876 LF 02				
37.464 VFA E68	06.98 -	D 2876 LF 03		8941.40.00	KZISZ-5	- GBox: ZF Ecosplit-3 - Vehicles with double disc clutch
40.273 DFAK T44	01.94 -	D 2876 LF 06				
40.373 DFAK T44	05.01 -					
40.373 DFK T43	05.01 -					
40.403 DFAK T44	01.94 -					
40.403 DFAS	01.94 -					
40.403 DFK T43	01.94 -					
40.414 DFK T43	05.01 -					
40.423 DFAK T44	05.01 -					
40.423 DFK T43	05.01 -					
40.463 DFAK T44	01.94 -					
40.463 DFAS T44	01.94 -					
40.463 DFK T43	01.94 -					
40.463 DFS	01.94 -					
40.464 DFAK T44	05.01 -					
40.464 DFAS T44	05.01 -					
40.464 DFK T43	05.01 -					
41.364 VF, VFC, VFRC T46	05.01 -					
41.364 VFK, VF-HK, VF-KI T46	03.02 -					
41.373 VF, VFC, VFRC T46	05.01 -					
41.373 VFK, VF-HK, VF-KI T46	03.02 -					
41.414 VF, VFC, VFRC T46	05.01 -					
41.414 VFK, VF-HK, VF-KI T46	03.02 -					
41.423 VF, VFC, VFRC T46	05.01 -					
41.423 VFK, VF-HK, VF-KI T46	03.02 -					
41.464 VF, VFC, VFRC T46	06.98 -					
41.464 VFK, VF-HK, VF-KI T46	03.02 -					
19.314 FAC T34	05.01 -			4300.90.051	430 10	
19.314 FAK, FA-KI, FAK-L T34	05.01 -			4301.20.00 43461.30.00 8916.40.00	MFZ430 430WGTZ KZIZ - 5	
19.323 FK,19.323 FLK T01, T02	01.94 - 12.95	D 2865 LF20		4300.90.49	430 10	
26.273 FNLC,26.273 FNLLC,26.273 FVLC T08, T07, T06	01.94 - 12.95	D 2865 LF21		4301.20.00 4346.30.00 8916.40.00	MFZ430 430WGTZ KZIZ - 5	
26.273 FNLS,26.273 FVLS T08, T06	01.94 - 12.95	D 2865 LF22				
26.293 FNLC,26.293 FNLLC,26.293 FVLC T08, T07, T06	01.94 -	D 2865 LF23		43460.30.00	430 10 430WGTZ	- Engine code: D2865LF
26.293 FNLS,26.293 FVLS T08, T06	01.94 -	D 2865 LF24				
26.323 FNLC,26.323 FNLLC,26.323 FVLC T07, T08, T06	01.94 - 12.95					
26.323 FNLS,26.323 FVLS T08, T06	01.94 - 12.95					
26.343 FNLC,26.343 FNLLC,26.343 FVLC T08, T07, T06	01.94 -					
26.343 FNLS,26.343 FVLS T08, T06	01.94 -					
27.273 DFAC T12	01.94 - 12.95					
27.273 DFAK T12	01.94 - 12.95					
27.273 DFAS T12	01.94 - 12.95					

Vehicle list



MAN

F 2000 01.94 -

19.464 FAC T34	06.98 -	D 2876 LF 06	4300.90.051 4301.20.00 43461.30.00 8916.40.00	430 10 MFZ430 430WGTZ KZIZ - 5	
			43461.30.00	430 10 430WGTZ	
			8950.40.00	KZIZ-6	
24.423 FNLLC T37 26.373 FNLC,26.373 FNLLC,26.373 FVLC T37, T36, T38 26.373 FNLS,26.373 FVLS T36, T38 26.403 FNLC,26.403 FNLLC,26.403 FVLC T37, T36, T38 26.403 FNLS,26.403 FVLS T36, T38 26.423 FNLC,26.423 FNLLC,26.423 FVLCT 37, T36, T38 26.423 FNLS,26.423 FVLS T36, T38 26.463 FNLC, FNLLC, FNLLRC, FNLLW, FNLCRC, FNLLRC, FVLC T37, T36, T38 26.463 FNLS,FVLS, FVLR T36, T38	01.94 - 12.95	D 2866 LF20	4300.90.051 4301.20.00 43461.30.00 8916.40.00	430 10 MFZ430 430WGTZ KZIZ - 5	- Engine code: D2866LF22
	01.94 - 12.95	D 2866 LF21	43461.30.00 8950.40.00	430 10 430WGTZ	
	01.94 - 12.95	D 2866 LF22			
	01.94 -	D 2876 LF 02	43461.30.00 8950.40.00	430 10 430WGTZ	- Engine code: D2866LF22 - For PTO
	01.94 -				
	01.94 - 12.95				
	01.94 -		4028.10.00 4036.30.00	400 MFZ2/400X	- Engine code: D2866LF22 - For PTO
	01.94 - 12.95				
	01.94 -		4036.30.00 8941.40.00	400 10 400 WGTZ	- GBox: ZF Ecosplit-3 - Vehicles with double disc clutch
01.94 -					
01.94 -		8941.40.00	KZISZ-5	- GBox: ZF Ecosplit-3 - Vehicles with double disc clutch	
01.94 -					
33.604 DFAS T72 33.604 DFS T78	04.00 -		4028.10.00	400 MFZ2/400X	- Engine code: D2840LF20
	04.00 -		4036.30.00	400 10 400 WGTZ	- Engine code: D2840LF20 - Loose clutch disc
			8941.40.00	KZISZ-5	- Engine code: D2840LF20
			4026.30.00	400 8 400GTZ	- Engine code: D2840LF20
18.273 T01,02,03 18.293 T01,02,03 18.323 T01,02,03 18.343 T01,02,03	01.94 -		4300.90.49 4301.20.00 4346.30.00 8916.40.00	430 10 MFZ430 430WGTZ KZIZ - 5	
	01.94 -		43460.30.00	430 10 430WGTZ	- Engine code: D2865LF - For PTO
	01.94 -				
01.94 -					

F 90 06.86 - 12.97

24.342 FNL,24.342 FNLL F18, F19	05.94 - 05.95	D 2865 LF09	4300.90.49 4301.20.00 4346.30.00 8916.40.00	430 10 MFZ430 430WGTZ KZIZ - 5	
			4000.90.01 $\Delta \nabla \text{HD}$ 4001.10.00 4010.30.00 8916.40.00	400 10 MFZ2/400X 400WGVZ KZIZ - 5	- From engine no.: 13213354-446654
24.362 DF F08 24.362 DFK F08 24.362 DFS,24.362 DFLS F08, F16 24.362 FNL,24.362 FNLL,24.362 FVL F07, F05, F06	04.87 - 02.90	D 2866 KF	4000.90.01 $\Delta \nabla \text{HD}$ 4001.10.00 4010.30.00 8916.40.00	400 10 MFZ2/400X 400WGVZ KZIZ - 5	
	04.87 - 02.90	D 2866 LXF			
	10.86 - 02.90				
24.372 FVL F07 24.372 FVLS F07	05.90 - 12.90	D 2866 LXF	4300.90.05 4301.20.00 4346.30.00 8916.40.00	430 10 MFZ430 430WGTZ KZIZ - 5	
	05.90 - 12.90		4000.90.01 $\Delta \nabla \text{HD}$ 4001.10.00 4010.30.00 8916.40.00	400 10 MFZ2/400X 400WGVZ KZIZ - 5	

Vehicle list



MAN





















































F 90 06.86 - 12.97

24.372 DF F08, F16, 272kW 24.372 DFS,24,372 DFLS F08, F16	02.90 - 12.90 02.90 - 04.95	D 2866 LF03		4300.90.05	430 10
				4301.20.00 4346.30.00 8916.40.00	MFZ430 430WGTZ KZIZ - 5
				4000.90.01 $\Delta \nabla$ H/D	400 10
				4001.10.00 4010.30.00 8916.40.00	MFZ2/400X 400WGVZ KZIZ - 5
24.372 DFK F08, 272kW 24.372 FNL,24.372 FNLL,24.372 FVLF07, F18, F05, F06, F19 24.372 FNLS,24.372 FVLSF07, F18, F05	02.90 - 12.90 02.90 - 05.95 02.90 - 05.95	D 2865 LF03 D 2865 LF05 D 2865 LF06 D 2865 LF09		4300.90.05	430 10
				4301.20.00 4346.30.00 8916.40.00	MFZ430 430WGTZ KZIZ - 5
24.402 FNL,24.402 FNLL F18, F19 26.342 DF,26.342 DFL F08, F16 26.342 DFK,26.342 DFLK F08, F16 26.342 DFS F08 26.402 DF,26.402 DFL F08, F16 26.402 DFK,26.402 DFLK F08, F16 26.402 DFS F08 26.402 FNL,26.402 FNLL,26.402 FVL F07, F18, F19 26.402 FNLS,26.402 FVLS F07, F18 32.292 VF F13 32.292 VFK F13 32.342 VFK F13 32.372 VF F13, 249kW 32.372 VFK F13, 249kW 32.402 VFK F13 33.272 DF F09 33.272 DFA F10 33.272 FVL F07 33.322 DF F09 33.322 FVL F07 33.342 DF F09 33.342 DFA F10 33.372 DFK F09 33.372 DFS F09 33.402 DF F09 33.402 DFA F10 33.402 DFAK F10	05.94 - 05.95 05.94 - 06.96 05.94 - 06.96 04.94 - 06.96 05.94 - 06.96 05.94 - 06.96 05.94 - 12.95 05.94 - 06.96 05.94 - 06.96 03.88 - 02.90 03.88 - 02.90 05.94 - 06.96 02.90 - 06.96 05.94 - 06.96 10.92 - 04.95 10.92 - 04.95 10.92 - 04.95 09.91 - 06.96 09.91 - 06.96 05.94 - 06.99 05.94 - 06.99 01.91 - 06.96 01.91 - 06.96 05.94 - 06.96 05.94 - 06.96 05.94 - 06.96	D 2866 LF/290 D 2866 LF03 D 2866 LF05 D 2866 LF15 D 2866 LF16 D 2866 LXF		4000.90.01 $\Delta \nabla$ H/D	400 10
				4001.10.00 4010.30.00 8916.40.00	MFZ2/400X 400WGVZ KZIZ - 5
24.422 DF F08 24.422 DFK F08 24.422 DFS,24.422 DFLS F08,F16 24.422 FNL,24.422 FNLL,24.422 FVL F07, F18, F05, F19, F06	02.90 - 12.90 02.90 - 12.90 02.90 - 12.90 02.90 - 05.95	D 2866 LF06 D 2866 LF09		4300.90.05	430 10
				4301.20.00 4346.30.00 8916.40.00	MFZ430 430WGTZ KZIZ - 5
				4000.90.01 $\Delta \nabla$ H/D	400 10
				4001.10.00 4010.30.00 8916.40.00	MFZ2/400X 400WGVZ KZIZ - 5
24.462 DF F28 24.462 DFS F28 24.462 FNL F25	02.89 - 02.90 02.89 - 02.90 04.89 - 02.90	D 2840 LF/460		4300.90.05	430 10
				4301.20.00 4346.30.00 8916.40.00	MFZ430 430WGTZ KZIZ - 5
				4000.90.01 $\Delta \nabla$ H/D	400 10
				4001.10.00 4010.30.00 8916.40.00	MFZ2/400X 400WGVZ KZIZ - 5

Vehicle list

					
---	---	---	--	---	---

MAN

F 90		06.86 - 12.97				
24.462 FVLS F07	05.87 - 07.87	D 2840 LF/460	 4000.90.01 $\Delta \nabla$ HD  4001.10.00  4010.30.00  8916.40.00	400 10 MFZ2/400X 400WGVZ KZIZ - 5		
24.502 DF F28 24.502 DFK F28 24.502 DFS F28 24.502 FNL F25 25.502 DF F28 25.502 DFS F28 25.502 FNL F25	02.90 - 12.90 02.90 - 12.90 02.90 - 12.90 02.90 - 12.90 09.90 - 12.92 09.90 - 12.92 09.90 - 12.92	D 2840 LF01 D 2840 LF04	 4300.90.05  4301.20.00  4346.30.00  8916.40.00  4000.90.01 $\Delta \nabla$ HD  4001.10.00  4010.30.00  8916.40.00	430 10 MFZ430 430WGTZ KZIZ - 5 400 10 MFZ2/400X 400WGVZ KZIZ - 5		
25.272 DF F08	09.90 - 12.92	D 2865 LF02 D 2865 LF05	 4000.90.01 $\Delta \nabla$ HD  4001.10.00  4010.30.00  8916.40.00	400 10 MFZ2/400X 400WGVZ KZIZ - 5		
25.272 DFK F08 25.272 DFS,25.272 DFSL F08, F16 25.272 FNL,25.272 FNLL,25.272 FVL F07, F05, F06	09.90 - 12.92 09.90 - 12.92 09.90 - 10.93	D 2865 LF02 D 2865 LF05	 4000.90.01 $\Delta \nabla$ HD  4001.10.00  4010.30.00  8916.40.00	400 10 MFZ2/400X 400WGVZ KZIZ - 5		
25.302 DF F08 25.302 DFK F08 25.302 DFS,25.302 DFSL F08, F16 25.302 FNL,25.302 FNLL F05, F06 25.302 FNLS,25.302 FVLS F07, F05	09.90 - 12.91 09.90 - 12.91 09.90 - 12.91 09.90 - 12.91 09.90 - 12.91	D 2866 LF04	 4000.90.01 $\Delta \nabla$ HD  4001.10.00  4010.30.00  8916.40.00	400 10 MFZ2/400X 400WGVZ KZIZ - 5		
25.322 DF, 25.322 DFL F08 25.322 DFK F08 25.322 DFS,25.322 DFSL F08, F16 25.322 FNL, 25.322 FNLL, 25.322 FVL F05, F06 25.322 FNLS,25.322 FVLS F07, F05	09.90 - 12.92 09.90 - 12.92 09.90 - 12.92 09.90 - 12.92 09.90 - 12.92	D 2865 LF03 D 2865 LF06	 4000.90.01 $\Delta \nabla$ HD  4001.10.00  4010.30.00  8916.40.00	400 10 MFZ2/400X 400WGVZ KZIZ - 5		
25.372 DF F08, 249kW 25.372 DF F08 25.372 DFK F08, 272kW 25.372 DFS,25.372 DFSL F08, F16 25.372 FNL, 25.372 FNLL, 25.372 FVL F F05, F06	09.90 - 12.92 09.90 - 10.93 09.90 - 12.92 09.90 - 12.92 09.90 - 12.92	D 2866 LF03 D 2866 LF05	 4300.90.05  4301.20.00  4346.30.00  8916.40.00  4000.90.01 $\Delta \nabla$ HD  4001.10.00  4010.30.00  8916.40.00	430 10 MFZ430 430WGTZ KZIZ - 5 400 10 MFZ2/400X 400WGVZ KZIZ - 5		
25.422 DF F08 25.422 DFK F08 25.422 DFS,25.422 DFSL F08, F16 25.422 FNL,25.422 FNLL F05, F06 25.422 FNLS,25.422 FVLS F07, F05	09.90 - 12.92 09.90 - 12.92 09.90 - 12.92 09.90 - 12.92 09.90 - 12.92	D 2866 LF06 D 2866 LF09	 4300.90.05  4301.20.00  4346.30.00  8916.40.00  4000.90.01 $\Delta \nabla$ HD  4001.10.00  4010.30.00  8916.40.00	430 10 MFZ430 430WGTZ KZIZ - 5 400 10 MFZ2/400X 400WGVZ KZIZ - 5		
26.242 DF F09 26.242 DFK F09 26.242 DFS F09	01.88 - 07.89 01.88 - 07.89 01.88 - 07.89	D 2866 F/240	 4000.90.01 $\Delta \nabla$ HD  4001.10.00  4010.30.00  8916.40.00	400 10 MFZ2/400X 400WGVZ KZIZ - 5		
26.242 DFAK F10	02.89 - 07.89	D 2866 F/240	 4000.90.01 $\Delta \nabla$ HD  4001.10.00  4010.30.00  8916.40.00	400 10 MFZ2/400X 400WGVZ KZIZ - 5		

Vehicle list

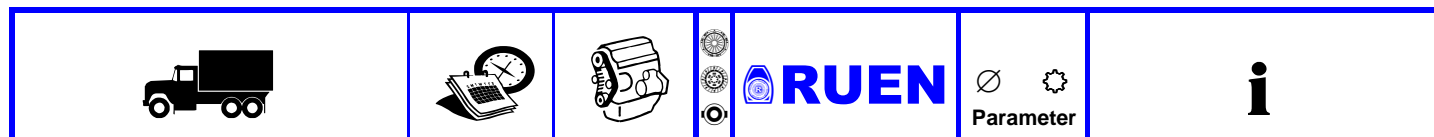

MAN

F 90 06.86 - 12.97









































26.262 DF F09 26.262 DFK F09 26.262 DFS F09	01.88 - 02.90 01.88 - 02.90 01.88 - 02.90	D 2865 LF/260	4000.90.01 $\Delta \nabla \text{HD}$ 4001.10.00 4010.30.00 8916.40.00	400 10 MFZ2/400X 400WGVZ KZIZ - 5	
26.262 DFA F10 26.262 DFAK F10 26.262 DFAS F10	02.89 - 02.90 02.89 - 02.90 02.89 - 02.90	D 2865 LF/260	4000.90.01 $\Delta \nabla \text{HD}$ 4001.10.00 4010.30.00 8916.40.00	400 10 MFZ2/400X 400WGVZ KZIZ - 5	
26.272 DF F09, F08 26.272 DFK F09, F08 26.272 DFS, 26.272 DFLS F09, F08, F16	02.90 - 06.96 02.90 - 06.96 02.90 - 06.96	D 2865 LF02 D 2865 LF05	4000.90.01 $\Delta \nabla \text{HD}$ 4001.10.00 4010.30.00 8916.40.00	400 10 MFZ2/400X 400WGVZ KZIZ - 5	
26.272 DFA F10 26.272 DFAK F10 26.272 DFAS F10	02.90 - 12.92 02.90 - 12.92 02.90 - 12.92	D 2865 LF02 D 2865 LF05	4000.90.01 $\Delta \nabla \text{HD}$ 4001.10.00 4010.30.00 8916.40.00	400 10 MFZ2/400X 400WGVZ KZIZ - 5	
26.272 FNL, 26.272 FNLL F18, F19 26.272 FNLS, 26.272 FVLS F07, F18	03.91 - 05.95 09.90 - 12.95	D 2865 LF02 D 2865 LF05	4000.90.01 $\Delta \nabla \text{HD}$ 4001.10.00 4010.30.00 8916.40.00	400 10 MFZ2/400X 400WGVZ KZIZ - 5	
26.292 DF F08 26.292 DFK F09 26.292 DFS F09	09.87 - 02.90 09.87 - 02.90 09.87 - 02.90	D 2866 LF/290	4300.90.05 4301.20.00 4346.30.00 8916.40.00	430 10 MFZ430 430WGTZ KZIZ - 5	
			4000.90.01 $\Delta \nabla \text{HD}$ 4001.10.00 4010.30.00 8916.40.00	400 10 MFZ2/400X 400WGVZ KZIZ - 5	
26.292 DFA F10 26.292 DFAS F10	05.88 - 02.90 05.88 - 02.90	D 2866 LF/290	4300.90.05 4301.20.00 4346.30.00 8916.40.00	430 10 MFZ430 430WGTZ KZIZ - 5	
			4000.90.01 $\Delta \nabla \text{HD}$ 4001.10.00 4010.30.00 8916.40.00	400 10 MFZ2/400X 400WGVZ KZIZ - 5	
26.292 DFAK F10	05.88 - 02.90	D 2866 LF/290	4000.90.01 $\Delta \nabla \text{HD}$ 4001.10.00 4010.30.00 8916.40.00	400 10 MFZ2/400X 400WGVZ KZIZ - 5	
			4300.90.05 4301.20.00 4346.30.00 8916.40.00	430 10 MFZ430 430WGTZ KZIZ - 5	
26.302 DF F09 26.302 DFS F09	05.90 - 12.91 05.90 - 12.91	D 2866 LF04	4000.90.01 $\Delta \nabla \text{HD}$ 4001.10.00 4010.30.00 8916.40.00	400 10 MFZ2/400X 400WGVZ KZIZ - 5	
26.302 DFA F10 26.302 DFAK F10 26.302 DFAS F10	05.90 - 12.91 05.90 - 12.91 05.90 - 12.91	D 2866 LF04	4000.90.01 $\Delta \nabla \text{HD}$ 4001.10.00 4010.30.00 8916.40.00	400 10 MFZ2/400X 400WGVZ KZIZ - 5	
26.302 DFK F09	05.90 - 12.91	D 2866 LF04	4000.90.01 $\Delta \nabla \text{HD}$ 4001.10.00 4010.30.00 8916.40.00	400 10 MFZ2/400X 400WGVZ KZIZ - 5	

Vehicle list

					
---	---	---	--	---	---

MAN

F 90 06.86 - 12.97

26.302 FNL,26.302 FNLL F18, F19 26.302 FNLS,26.302 FVLS F07, F18	03.91 - 12.91 09.90 - 12.91	D 2866 LF04	   	4000.90.01 $\Delta \nabla \text{HD}$ 4001.10.00 4010.30.00 8916.40.00	400 10 MFZ2/400X 400WGVZ KZIZ - 5
26.322 DF F09, F08 26.322 DFS,26.322 DFSL F09, F08, F16	02.90 - 06.96 02.90 - 06.96	D 2865 LF03 D 2865 LF06	   	4000.90.01 $\Delta \nabla \text{HD}$ 4001.10.00 4010.30.00 8916.40.00	400 10 MFZ2/400X 400WGVZ KZIZ - 5
26.322 DFA F10 26.322 DFAK F10 26.322 DFAS F10	02.90 - 12.92 02.90 - 12.92 02.90 - 12.92	D 2865 LF03 D 2865 LF06	   	4000.90.01 $\Delta \nabla \text{HD}$ 4001.10.00 4010.30.00 8916.40.00	400 10 MFZ2/400X 400WGVZ KZIZ - 5
26.322 DFK F09, F08 26.322 FNL,26.322 FNLL F18, F19 26.322 FNLS,26.322 FVLS F07, F18	02.92 - 06.96 03.91 - 05.95 09.90 - 12.95	D 2865 LF03 D 2865 LF06	   	4000.90.01 $\Delta \nabla \text{HD}$ 4001.10.00 4010.30.00 8916.40.00	400 10 MFZ2/400X 400WGVZ KZIZ - 5
26.332 DF F08 26.332 DFK F09 26.332 DFS F09	09.87 - 02.90 09.87 - 02.90 09.87 - 02.90	D 2866 LF/330	   	4300.90.05 4301.20.00 4346.30.00 8916.40.00	430 10 MFZ430 430WGTZ KZIZ - 5
26.332 DFA F10 26.332 DFAK F10 26.332 DFAS F10	09.87 - 02.90 05.88 - 02.90 05.88 - 02.90	D 2866 LF/330	   	4000.90.01 $\Delta \nabla \text{HD}$ 4001.10.00 4010.30.00 8916.40.00	400 10 MFZ2/400X 400WGVZ KZIZ - 5
26.362 DF,26.362 DFL F09, F16	09.87 - 02.90	D 2866 KF D 2866 LXF	   	4300.90.05 4301.20.00 4346.30.00 8916.40.00	430 10 MFZ430 430WGTZ KZIZ - 5
26.362 DFK F09 26.362 DFS F09	09.87 - 02.90 09.87 - 02.90	D 2866 KF D 2866 LXF	   	4000.90.01 $\Delta \nabla \text{HD}$ 4001.10.00 4010.30.00 8916.40.00	400 10 MFZ2/400X 400WGVZ KZIZ - 5
26.362 DFA F10 26.362 DFAK F10 26.362 DFAS F10	05.88 - 02.90 05.88 - 02.90 05.88 - 02.90	D 2866 LXF	   	4300.90.05 4301.20.00 4346.30.00 8916.40.00	430 10 MFZ430 430WGTZ KZIZ - 5
			   	4000.90.01 $\Delta \nabla \text{HD}$ 4001.10.00 4010.30.00 8916.40.00	400 10 MFZ2/400X 400WGVZ KZIZ - 5

Vehicle list









MAN

























































F 90 06.86 - 12.97

26.372 DF,26.372 DFL F09, F08, F16 26.372 DFS F09, F08	02.90 - 06.96 02.90 - 06.96	D 2866 LF03 D 2866 LF05 D 2866 LF15	4300.90.05 4301.20.00 4346.30.00 8916.40.00	430 10 MFZ430 430WGTZ KZIZ - 5	
			4000.90.01 $\Delta \nabla$ H/D 4001.10.00 4010.30.00 8916.40.00	400 10 MFZ2/400X 400WGVZ KZIZ - 5	
26.372 DFA F10 26.372 DFAK F10 26.372 DFAS F10	02.90 - 12.90 01.92 - 06.96 02.90 - 12.92	D 2866 LF03 D 2866 LF05	4300.90.05 4301.20.00 4346.30.00 8916.40.00	430 10 MFZ430 430WGTZ KZIZ - 5	
			4000.90.01 $\Delta \nabla$ H/D 4001.10.00 4010.30.00 8916.40.00	400 10 MFZ2/400X 400WGVZ KZIZ - 5	
26.372 DFK F08 26.372 FNL,26.372 FNLL,26.372 FVL F07, F18, F19 26.372 FNLS,26.372 FVLS F07, F18	01.92 - 06.96 09.90 - 12.95 01.92 - 06.96	D 2866 LF03 D 2866 LF05 D 2866 LF15	4300.90.05 4301.20.00 4346.30.00 8916.40.00	430 10 MFZ430 430WGTZ KZIZ - 5	
			4000.90.01 $\Delta \nabla$ H/D 4001.10.00 4010.30.00 8916.40.00	400 10 MFZ2/400X 400WGVZ KZIZ - 5	
26.422 DF,26.422 DFL F08, F09, F16 26.422 DFK F09, F08 26.422 DFS F09, F08	02.90 - 06.96 02.90 - 12.95 02.90 - 12.95	D 2866 LF06 D 2866 LF09	4300.90.05 4301.20.00 4346.30.00 8916.40.00	430 10 MFZ430 430WGTZ KZIZ - 5	
			4000.90.01 $\Delta \nabla$ H/D 4001.10.00 4010.30.00 8916.40.00	400 10 MFZ2/400X 400WGVZ KZIZ - 5	
26.422 DFA F10 26.422 DFAK F10 26.422 DFAS F10	02.90 - 12.92 02.90 - 12.92 02.90 - 12.92	D 2866 LF06 D 2866 LF09	4300.90.05 4301.20.00 4346.30.00 8916.40.00	430 10 MFZ430 430WGTZ KZIZ - 5	
			4000.90.01 $\Delta \nabla$ H/D 4001.10.00 4010.30.00 8916.40.00	400 10 MFZ2/400X 400WGVZ KZIZ - 5	
26.422 FNL,26.422 FNLL,26.422 FVL F07, F18, F19 26.422 FNLS,26.422 FVLS F07, F18	09.90 - 12.95 01.92 - 12.95	D 2866 LF06 D 2866 LF09	4300.90.05 4301.20.00 4346.30.00 8916.40.00	430 10 MFZ430 430WGTZ KZIZ - 5	
			4000.90.01 $\Delta \nabla$ H/D 4001.10.00 4010.30.00 8916.40.00	400 10 MFZ2/400X 400WGVZ KZIZ - 5	
26.462 DF F29 26.462 DFS F29	02.89 - 02.90 02.89 - 02.90	D 2840 LF/460	4300.90.05 4301.20.00 4346.30.00 8916.40.00	430 10 MFZ430 430WGTZ KZIZ - 5	
			4000.90.01 $\Delta \nabla$ H/D 4001.10.00 4010.30.00 8916.40.00	400 10 MFZ2/400X 400WGVZ KZIZ - 5	

Vehicle list

					
---	---	---	--	---	---

MAN







F 90		06.86 - 12.97		
26.502 DF F28, F29 26.502 DFS,26.502 DFLS F36, F29, F28 26.502 FNL,26.502 FNLL F25, F39	02.90 - 06.96 02.90 - 06.96 09.91 - 06.96	D 2840 LF01 D 2840 LF04 D 2840 LF06	 4300.90.05  4301.20.00  4346.30.00  8916.40.00  4000.90.01 $\Delta \nabla \text{HD}$  4001.10.00  4010.30.00  8916.40.00	430 10 MFZ430 430WGTZ KZIZ - 5 400 10 MFZ2/400X 400WGVZ KZIZ - 5
27.292 F10	01.86 - 12.92		 4300.90.05  4301.20.00  4346.30.00  8916.40.00	430 10 MFZ430 430WGTZ KZIZ - 5
27.332 F10	01.86 - 12.92		 4300.90.05  4301.20.00  4346.30.00  8916.40.00	430 10 MFZ430 430WGTZ KZIZ - 5
27.362 F10	01.87 - 12.92		 4300.90.05  4301.20.00  4346.30.00  8916.40.00	430 10 MFZ430 430WGTZ KZIZ - 5
27.372 F09,10	01.90 -		 4300.90.05  4301.20.00  4346.30.00  8916.40.00	430 10 MFZ430 430WGTZ KZIZ - 5
27.462 F30	01.89 -		 4300.90.05  4301.20.00  4346.30.00  8916.40.00  4000.90.01 $\Delta \nabla \text{HD}$  4001.10.00  4010.30.00  8916.40.00	430 10 MFZ430 430WGTZ KZIZ - 5 400 10 MFZ2/400X 400WGVZ KZIZ - 5
27.502 F30	01.90 -		 4300.90.05  4301.20.00  4346.30.00  8916.40.00  4000.90.01 $\Delta \nabla \text{HD}$  4001.10.00  4010.30.00  8916.40.00	430 10 MFZ430 430WGTZ KZIZ - 5 400 10 MFZ2/400X 400WGVZ KZIZ - 5
28.362 F09,13,14	01.87 -		 4300.90.05  4301.20.00  4346.30.00  8916.40.00	430 10 MFZ430 430WGTZ KZIZ - 5
28.372 F09,13,14 30.372 F13,14 31.372 F13,14	01.90 - 01.90 - 01.90 -		 4300.90.05  4301.20.00  4346.30.00  8916.40.00	430 10 MFZ430 430WGTZ KZIZ - 5
28.402 F14	01.88 -		 4300.90.05  4301.20.00  4346.30.00  8916.40.00	430 10 MFZ430 430WGTZ KZIZ - 5
30.342 F14 41.342 VF F14	01.94 - 05.94 - 06.96	D 2865 LF09	 4300.90.49  4301.20.00  4346.30.00  8916.40.00	430 10 MFZ430 430WGTZ KZIZ - 5

Vehicle list

















MAN						
F 90						
06.86 - 12.97						
30.362 F13,14 31.362 F13,14	01.87 - 01.87 -			4300.90.05 4301.20.00 4346.30.00 8916.40.00	430 10 MFZ430 430WGTZ KZIZ - 5	
30.402 F14	01.94 -			4300.90.05 4301.20.00 4346.30.00 8916.40.00	430 10 MFZ430 430WGTZ KZIZ - 5	
31.342 F14 32.342 F14	01.94 - 01.94 -			4300.90.49 4301.20.00 4346.30.00 8916.40.00	430 10 MFZ430 430WGTZ KZIZ - 5	
31.402 F14	01.94 -			4300.90.05 4301.20.00 4346.30.00 8916.40.00	430 10 MFZ430 430WGTZ KZIZ - 5	
32.332 VF F13 32.332 VFK F13	03.88 - 02.90 03.88 - 02.90	D 2866 LF/330		4300.90.05 4301.20.00 4346.30.00 8916.40.00	430 10 MFZ430 430WGTZ KZIZ - 5	
32.362 VF F13 32.362 VFK F13	03.88 - 02.90 03.88 - 02.90	D 2866 LXF		4300.90.05 4301.20.00 4346.30.00 8916.40.00	430 10 MFZ430 430WGTZ KZIZ - 5	
32.372 VF F13 32.372 VFK F13	02.90 - 06.96 02.90 - 06.96	D 2866 LF03 D 2866 LF05 D 2866 LF15		4300.90.05 4301.20.00 4346.30.00 8916.40.00	430 10 MFZ430 430WGTZ KZIZ - 5	
32.402 F14 41.402 VF F14	01.94 - 05.94 - 06.96	D 2866 LF16		4300.90.05 4301.20.00 4346.30.00 8916.40.00	430 10 MFZ430 430WGTZ KZIZ - 5	
32.422 VF F13 32.422 VFK	02.90 - 06.96 02.90 - 06.96	D 2866 LF06 D 2866 LF09		4300.90.05 4301.20.00 4346.30.00 8916.40.00	430 10 MFZ430 430WGTZ KZIZ - 5	
33.292 DF F10 33.292 DFA F10 33.292 DFAK F10 33.292 DFAS F10 33.332 DFA F10	09.87 - 02.90 05.88 - 02.90 05.88 - 02.90 05.88 - 02.90 05.88 - 02.90	D 2866 LF/290 D 2866 LF/330		4300.90.05 4301.20.00 4346.30.00 8916.40.00	430 10 MFZ430 430WGTZ KZIZ - 5	
33.292 DFK F10 33.292 DFS F10 33.332 DFK F09 33.332 DFS F09	09.87 - 02.90 09.87 - 02.90 09.87 - 02.90 09.87 - 02.90	D 2866 LF/290 D 2866 LF/330		4300.90.05 4301.20.00 4346.30.00 8916.40.00	430 10 MFZ430 430WGTZ KZIZ - 5	
33.332 DF F09	09.87 - 02.90	D 2866 LF/330		4300.90.05 4301.20.00 4346.30.00 8916.40.00	430 10 MFZ430 430WGTZ KZIZ - 5	
33.362 DF F09 33.362 DFS F09	09.87 - 02.90 09.87 - 02.90	D 2866 KF D 2866 LX		4300.90.05 4301.20.00 4346.30.00 8916.40.00	430 10 MFZ430 430WGTZ KZIZ - 5	

Vehicle list

					
---	---	---	--	---	---

MAN

F 90		06.86 - 12.97				
33.362 DFK F09	09.87 - 02.90	D 2866 KF D 2866 LX		4300.90.05 4301.20.00 4346.30.00 8916.40.00	430 10 MFZ430 430WGTZ KZIZ - 5	
33.362 DFA F10 33.362 DFAK F10 33.362 DFAS F10	05.88 - 02.90 05.88 - 02.90 05.88 - 02.90	D 2866 LXF		4300.90.05 4301.20.00 4346.30.00 8916.40.00	430 10 MFZ430 430WGTZ KZIZ - 5	
33.372 DF F10 33.372 DFA F10 33.372 DFAK F10	09.91 - 06.96 09.91 - 06.96 01.91 - 06.96	D 2866 LF03 D 2866 LF05 D 2866 LF15		4300.90.05 4301.20.00 4346.30.00 8916.40.00	430 10 MFZ430 430WGTZ KZIZ - 5	
33.422 DFA F10 33.422 DFAK F10	09.91 - 06.96 01.94 - 06.96	D 2866 LF06 D 2866 LF09		4300.90.05 4301.20.00 4346.30.00 8916.40.00	430 10 MFZ430 430WGTZ KZIZ - 5	
33.462 DF F29 33.462 DFA F30	07.89 - 02.90 07.89 - 02.90	D 2840 LF/460		4300.90.05 4301.20.00 4346.30.00 8916.40.00	430 10 MFZ430 430WGTZ KZIZ - 5	
				4000.90.01 $\Delta \nabla$ HD 4001.10.00 4010.30.00 8916.40.00	400 10 MFZ2/400X 400WGVZ KZIZ - 5	
33.502 DF F29 33.502 DFA F30	09.91 - 06.96 09.91 - 06.96	D 2840 LF01 D 2840 LF04 D 2840 LF06		4300.90.05 4301.20.00 4346.30.00 8916.40.00	430 10 MFZ430 430WGTZ KZIZ - 5	
				4000.90.01 $\Delta \nabla$ HD 4001.10.00 4010.30.00 8916.40.00	400 10 MFZ2/400X 400WGVZ KZIZ - 5	
34.322 F14 36.322 F14	01.94 - 01.90 -			4300.90.49 4301.20.00 4346.30.00 8916.40.00	430 10 MFZ430 430WGTZ KZIZ - 5	
34.342 F14 36.342 F14	01.94 - 01.94 -			4300.90.49 4301.20.00 4346.30.00 8916.40.00	430 10 MFZ430 430WGTZ KZIZ - 5	
34.372 F14	01.90 -			4300.90.49 4301.20.00 4346.30.00 8916.40.00	430 10 MFZ430 430WGTZ KZIZ - 5	
34.402 F14 36.402 F14	01.94 - 01.94 -			4300.90.05 4301.20.00 4346.30.00 8916.40.00	430 10 MFZ430 430WGTZ KZIZ - 5	
35.292 VF F14 35.292 VFK F14	10.88 - 04.95 10.88 - 04.95	D 2866 LFZ/290		4300.90.05 4301.20.00 4346.30.00 8916.40.00	430 10 MFZ430 430WGTZ KZIZ - 5	
35.342 VF F14 35.342 VFK F14	05.94 - 06.96 05.94 - 06.96	D 2865 LF09		4300.90.49 4301.20.00 4346.30.00 8916.40.00	430 10 MFZ430 430WGTZ KZIZ - 5	

Vehicle list

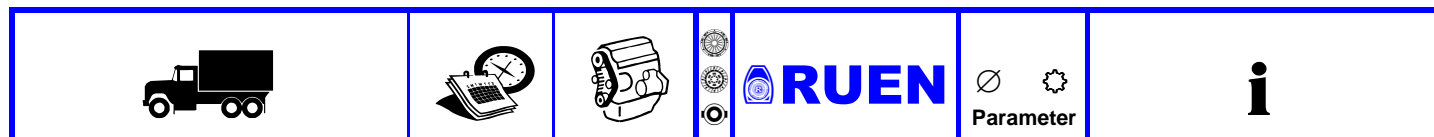

MAN

F 90 06.86 - 12.97

35.362 F14	01.88 - 12.93			4300.90.05 4301.20.00 4346.30.00 8916.40.00	430 10 MFZ430 430WGTZ KZIZ - 5	
35.372 VF F14, 249kW, 8x4/4 35.372 VF F14, 272kW, 8x4/4 35.372 VF, 272kW, 8x6/4 35.372 VFK F14, 272kW, 8x4/4	02.90 - 04.95 02.90 - 06.96 02.90 - 12.97 02.90 - 06.96	D 2866 LF03 D 2866 LF05 D 2866 LF15		4300.90.05 4301.20.00 4346.30.00 8916.40.00	430 10 MFZ430 430WGTZ KZIZ - 5	
35.402 VF F14, 8x4/4 35.402 VF F14, 8x6/4 35.402 VFK F14, 8x4/4	05.94 - 06.96 05.94 - 12.97 05.94 - 06.96	D 2866 LF16		4300.90.05 4301.20.00 4346.30.00 8916.40.00	430 10 MFZ430 430WGTZ KZIZ - 5	
35.422 VF F14, 8x4/4 35.422 VF F14, 8x6/4 35.422 VFK F14, 8x4/4 35.422 VFK F14, 8x6/4	02.90 - 06.96 02.90 - 12.97 02.90 - 06.96 02.90 - 12.97	D 2866 LF06 D 2866 LF09		4300.90.05 4301.20.00 4346.30.00 8916.40.00	430 10 MFZ430 430WGTZ KZIZ - 5	
36.362 F14	01.88 - 12.93			4300.90.05 4301.20.00 4346.30.00 8916.40.00	430 10 MFZ430 430WGTZ KZIZ - 5	
36.372 F14	01.90 -			4300.90.05 4301.20.00 4346.30.00 8916.40.00	430 10 MFZ430 430WGTZ KZIZ - 5	
36.422 F14	01.90 -			4300.90.05 4301.20.00 4346.30.00 8916.40.00	430 10 MFZ430 430WGTZ KZIZ - 5	
38.372				4000.90.01 $\Delta \nabla$ HD 4001.10.00 4010.30.00 8916.40.00	400 10 MFZ2/400X 400WGVZ KZIZ - 5	
40.362 F12	01.90 -			4000.90.01 $\Delta \nabla$ HD 4001.10.00 4010.30.00 8916.40.00	400 10 MFZ2/400X 400WGVZ KZIZ - 5	
40.372 DF F11 40.422 F11	12.91 - 06.96 01.90 -	D 2866 LF03 D 2866 LF05 D 2866 LF15		4000.90.01 $\Delta \nabla$ HD 4001.10.00 4010.30.00 8916.40.00	400 10 MFZ2/400X 400WGVZ KZIZ - 5	
40.402 DF F11 40.422 DF F11	05.95 - 06.96 12.91 - 06.96	D 2866 LF06 D 2866 LF09 D 2866 LF16		4300.90.05 4301.20.00 4346.30.00 8916.40.00	430 10 MFZ430 430WGTZ KZIZ - 5	
				4000.90.01 $\Delta \nabla$ HD 4001.10.00 4010.30.00 8916.40.00	400 10 MFZ2/400X 400WGVZ KZIZ - 5	
40.422 DFA F12	12.91 - 06.96	D 2866 LF06 D 2866 LF09		4300.90.05 4301.20.00 4346.30.00 8916.40.00	430 10 MFZ430 430WGTZ KZIZ - 5	
				4000.90.01 $\Delta \nabla$ HD 4001.10.00 4010.30.00 8916.40.00	400 10 MFZ2/400X 400WGVZ KZIZ - 5	

Vehicle list



MAN

F 90 06.86 - 12.97

40.462 DF 48.462 VF F15	07.89 - 02.90 07.89 - 02.90	D 2840 LF/460	4300.90.05 4301.20.00 4346.30.00 8916.40.00	430 10 MFZ430 430WGTZ KZIZ - 5	
40.462 DFA F32 40.502 DFA F32	07.89 - 02.90 02.90 - 06.96	D 2840 LF/460 D 2840 LF01 D 2840 LF04 D 2840 LF06	4000.90.01 $\Delta \nabla \text{HD}$ 4001.10.00 4010.30.00 8916.40.00	400 10 MFZ2/400X 400WGVZ KZIZ - 5	
41.292 VF F14 41.292 VFK F14 41.332 VF F14 41.332 VFK F14	10.88 - 02.90 10.88 - 02.90 10.88 - 02.90 10.88 - 02.90	D 2866 LF/290 D 2866 LF/330	4300.90.05 4301.20.00 4346.30.00 8916.40.00	430 10 MFZ430 430WGTZ KZIZ - 5	
41.322 VF F14	02.90 - 06.96	D 2865 LF03 D 2865 LF06	4300.90.49 4301.20.00 4346.30.00 8916.40.00	430 10 MFZ430 430WGTZ KZIZ - 5	
41.362 VF F14 41.362 VFK F14	10.88 - 02.90 10.88 - 02.90	D 2866 LXF	4300.90.05 4301.20.00 4346.30.00 8916.40.00	430 10 MFZ430 430WGTZ KZIZ - 5	
41.372 VF F14	02.90 - 06.96	D 2866 LF03 D 2866 LF05 D 2866 LF15	4300.90.05 4301.20.00 4346.30.00 8916.40.00	430 10 MFZ430 430WGTZ KZIZ - 5	
41.422 VF F14	02.90 - 06.96	D 2866 LF06 D 2866 LF09	4300.90.05 4301.20.00 4346.30.00 8916.40.00	430 10 MFZ430 430WGTZ KZIZ - 5	
16.242 F01,02,03 27.272 F05,06,07,08,09,10 28.272 F05-10,13,14 30.262 F13,14 30.272 F13,14 31.262 F13,14 31.272 F13,14 32.242 F09,10 32.262 VF F13 32.262 VFK F13 32.262 VFTM F13 33.242 DFAK F09 33.242 DFK F09 36.262 F14 36.272 F14	01.85 - 01.90 - 01.90 - 01.89 - 01.90 - 01.89 - 01.90 - 01.87 - 12.92 02.89 - 02.90 02.89 - 02.90 02.89 - 02.90 01.88 - 08.88 01.88 - 08.88 01.88 - 12.93 01.88 - 12.93	D 2865 LF/260 D 2866 F/240	4008.30.00 8916.40.00	400 10 400 WGVZ KZIZ - 5	- Engine code: D2866F - Engine code: D2866F

Vehicle list



MAN

F 90 06.86 - 12.97

16.292 F01,02,03	01.85 - 12.92	D 2866 LF03	4300.90.051	430 10	- Engine code: D2866LF
16.332 F01,02,03	01.85 - 12.92	D 2866 LF05	4301.20.00	MFZ430	07,08,01,03,04,05;
16.372 F01,02,03	01.90 -	D 2866 LF15	43461.30.00	430WGTZ	
28.292 F09,13,14	01.86 -		8916.40.00	KZIZ - 5	
28.322 F09,13,14	01.90 -		4009.30.00	400 10	- Engine code: D2866LF
28.332 F09,13,14	01.86 -			400WGVZ	07,08,01,03,04,05;
30.292 F13,14	01.87 -		8916.40.00	KZIZ - 5	- Engine code: D2866LF
30.332 F13,14	01.87 -				07,08,01,03,04,05;
31.292 F13,14	01.87 -				
31.332 F13,14	01.87 -				
32.292 F09,10,13,14	01.85 -				
35.372 VFK	02.90 - 12.97				
36.292 F14	01.88 - 12.93				
36.332 F14	01.88 - 12.93				
38.292 F17	01.85 -				
38.332 F17	01.85 -				
16.302 F01,02,03	01.90 - 12.92	D 2866 LF08	4009.30.00	400 10	- Engine code: D2866LF04,03
16.322 F01,02,03,U11	01.90 -	D 2865 LF03		400WGVZ	
23.372 F20	06.93 -	D 2865 LF06	8916.40.00	KZIZ - 5	- Engine code: D2866LF04,03
24.372 F20	01.92 - 06.93	D 2866 LF/290			
26.332 F19	01.91 -				
27.302 F10	01.90 - 12.92				
28.302 F09,13,14	01.90 -				
30.302 F13,14	01.90 -				
30.322 F13,14	01.90 -				
31.302 F13,14	01.90 -				
31.322 F13,14	01.90 -				
32.322 VF F13	02.90 - 06.96				
32.322 VFK F13	02.90 - 06.96				
38.302 F17	01.89 -				
48.292 VF F15	07.89 - 02.90				
48.292 VFA F15	07.89 - 02.90				
48.292 VFAK F15	07.89 - 02.90				
16.342 F01,02,03	01.94 -	D 2865 LF09	4300.90.49	430 10	- Engine code: D2865LF; 21;
19.342 F,19.342 FL,19.342 FLL F02, F03, F01	05.94 - 05.95		4301.20.00	MFZ430	
19.342 FA F04	05.94 - 06.96		4346.30.00	430WGTZ	
19.342 FAK F04	05.94 - 06.96		8916.40.00	KZIZ - 5	
19.342 FAS F04	05.94 - 06.96		43460.30.00	430 10	
19.342 FK F01	05.94 - 05.95			430WGTZ	
19.342 FS,19.342 FLS,19.342 FLLS F02, F03, F01	05.94 - 05.95				
23.342 F20	01.94 -				
24.342 F20	01.94 -				
28.342 F14	01.88 -				

Vehicle list



MAN

F 90 06.86 - 12.97

16.362 F01,02,03,U11,13	01.85 - 12.92	D 2866 LF	4300.90.051	430 10	- Engine code: D2866,KF,KU,LXF,LF,06,09;
16.402 F01,02,03	01.94 -	D 2866 LF/330	4301.20.00	MFZ430	
16.422 F01,02,03,U11	01.90 -	D 2866 LF06	43461.30.00	430WGTZ	
19.402 F,19.402 FL,19.402 FLL F02, F03, F01	05.94 - 05.95	D 2866 LF09	8916.40.00	KZIZ - 5	
19.402 FA F04	05.94 - 06.96	D 2866 LF16			
19.402 FAK F04	05.94 - 06.96	D 2866 LXF			
19.402 FAS F04	05.94 - 06.96				
19.402 FK F01	05.94 - 05.95				
19.402 FS,19.402 FLS,19.402 FLLS F02, F03, F01	05.94 - 05.95				
19.432	01.94 -				
23.372 F20	01.88 -				
23.422 F20	01.92 -				
24.372 F20	07.93 -				
27.422 F09,10	01.90 -				
28.422 F09,13,14	01.90 -				
30.422 F13,14	01.90 -				
31.422 F13,14	01.90 -				
38.362 F17	01.89 -				
38.422 F17	01.89 -				
48.332 VF F15	07.89 - 02.90				
48.332 VFA F15	07.89 - 02.90				
48.332 VFAK F15	07.89 - 02.90				
48.362 VF F15	07.89 - 02.90				
48.362 VFA	07.89 - 02.90				
48.362 VFAK F15	07.89 - 02.90				
19.242 F,19.242 FL,19.242 FLL F02, F03, F01	01.88 - 01.89	D 2866 F/240	4008.30.00	400 10 400 WGVZ	- Engine code: D2866F
19.242 FK F01	01.88 - 02.89		8916.40.00	KZIZ - 5	- Engine code: D2866F
19.242 FS,19.242 FLS,19.242 FLLS F02, F03, F01	01.89 - 01.89		4009.30.00	400 10 400WGVZ	- Engine code: D2866F
			4286.30.00	420 10 420WGTZ	- Engine code: D2866
19.292 F,19.292 FL,19.292 FLL F02, F03, F01	07.86 - 02.90	D 2866 LF/290	4300.90.051	430 10	- Engine code: D2866LF07 - Engine code: D2865LF
19.292 FA F04	05.88 - 02.90		4301.20.00	MFZ430	
19.292 FAK F04	05.88 - 02.90		43461.30.00	430WGTZ	
19.292 FAS F04	05.88 - 02.90		8916.40.00	KZIZ - 5	
19.292 FK F01	07.86 - 02.90		4008.30.00	400 10 400 WGVZ	- Engine code: D2866LF07 - Engine code: D2865LF
19.292 FS,19.292 FLS,19.292 FLLS F02, F03, F01	07.86 - 02.90		8916.40.00	KZIZ - 5	- Engine code: D2866LF07 - Engine code: D2865LF
			4009.30.00	400 10 400WGVZ	- Engine code: D2866LF07 - Engine code: D2865LF
			4286.30.00	420 10 420WGTZ	- Engine code: D2866, D2865

Vehicle list



MAN

F 90 06.86 - 12.97

19.302 F01,02,03,04	01.90 - 12.92	D 2865 LF03	4009.30.00	400 10 400WGVZ	- Engine code: D2866LF 04,03,06;
26.292 F19	01.90 -	D 2865 LF06	8916.40.00	KZIZ - 5	- Engine code: D2866LF04,03,06;
27.322 F09,10	01.90 -	D 2866 LF04	4286.30.00	420 10 420WGTZ	- Engine code: D2866LF - For PTO
32.302 VF F13	05.90 - 09.91				
32.302 VFK F13	05.90 - 09.91				
33.302 F10,13,14	01.90 -				
33.322 DFA F10	09.91 - 06.96				
35.302 VF F14	05.90 - 09.91				
	05.90 - 09.91				
35.302 VFK F14	05.90 - 09.91				
	05.90 - 09.91				
35.322 VFAK E15	02.90 - 06.96				
35.322 VFK F14	02.90 - 06.96				
35.322 VFK E15	02.90 - 06.96				
35.322 VK F14	02.90 - 06.96				
36.302 F14	01.90 - 12.93				
41.302 F14	01.90 -				
19.322 F,19.322 FL,19.322 FLL F02, F03, F01	02.90 - 05.95	D 2865 LF03	4300.90.49	430 10 MFZ430	- To model year: 08/1993 - Engine code: D2865LF03,06
19.322 FA F04	02.90 - 06.96	D 2865 LF05	4301.20.00	430WGTZ	
19.322 FAK F04	02.90 - 06.96	D 2865 LF06	4346.30.00	KZIZ - 5	
19.322 FAS F04	02.90 - 06.96		8916.40.00		
19.322 FK F01	02.90 - 06.96		4009.30.00	400 10 400WGVZ	- To model year: 07/1993 - Engine code: D2865LF03,06
19.322 FS,19.322 FLS,19.322 FLLS F02, F03, F01	02.90 - 05.95		8916.40.00	KZIZ - 5	- To model year: 07/1993 - Engine code: D2865LF03,06
	02.90 - 05.95		4286.30.00	420 10 420WGTZ	- Engine code: D2865 - For PTO
	02.90 - 05.95		43460.30.00	430 10 430WGTZ	
19.332 F,19.332 FL,19.332 FLL F02, F03, F01	07.86 - 02.90	D 2866 LF/330	4300.90.051	430 10 MFZ430	- Engine code: D2866LF08,01,03,05
19.332 FA F04	05.88 - 02.90	D 2866 LF03	4301.20.00	430WGTZ	
19.332 FAK F04	05.88 - 02.90	D 2866 LF05	43461.30.00	KZIZ - 5	
19.332 FAS F04	05.88 - 02.90	D 2866 LF15	8916.40.00		
19.332 FK F01	07.86 - 02.90		4009.30.00	400 10 400WGVZ	- Engine code: D2866LF08,01,03,05
19.332 FS,19.332 FLS,19.332 FLLS F02, F03, F01	07.86 - 02.90		8916.40.00	KZIZ - 5	- Engine code: D2866LF08,01,03,05
19.372 F,19.372 FL,19.372 FLL F02, F03, F01	02.90 - 05.95		4286.30.00	420 10 420WGTZ	- Engine code: D2866 - For PTO
19.372 FA F04	02.90 - 06.96				
19.372 FAK F04	02.90 - 06.96				
19.372 FAS F04	02.90 - 06.96				
19.372 FK F01	02.90 - 05.95				
19.372 FS,19.372 FLS,19.372 FLLS F02, F03, F01	02.90 - 05.95				
33.332 DFAK F10	05.88 - 02.90				
33.332 DFAS F10	05.88 - 02.90				

Vehicle list

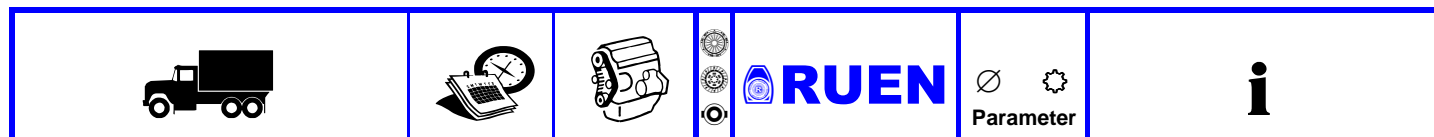

MAN

F 90		06.86 - 12.97				
19.362 FK F01	07.86 - 02.90	D 2866 KF	4300.90.051	430 10	- Engine code: D2866KF,06,09	
19.362 FS,19.362 FLS,19.362 FLLS F02, F03, F01	07.86 - 02.90	D 2866 LF06	4301.20.00	MFZ430		
19.422 F,19.422 FL,19.422 FLL F02, F03, F01	02.90 - 05.95	D 2866 LF09	43461.30.00	430WGTZ		
19.422 FA F04	02.90 - 06.96	D 2866 LF10	8916.40.00	KZIZ - 5		
19.422 FAK F04	02.90 - 06.96	D 2866 LF16	4286.30.00	420 10	- Engine code: D2866	
19.422 FAS F04	02.90 - 06.96	D 2866 LXF		420WGTZ	- For PTO	
19.422 FK F01	02.90 - 05.95					
19.422 FS,19.422 FLS,19.422 FLLS F02, F03, F01	02.90 - 05.95					
35.402 VFK F14	05.94 - 12.97					
17.462 F21,22	01.89 -	D 2840 LF01	4300.90.051	430 10	- Engine code: D2840LF,01,04	
17.502 F21,22	01.89 -	D 2840 LF04	4301.20.00	MFZ430		
19.462 F21,22	01.89 -	D 2840 LF06	43461.30.00	430WGTZ		
19.502 F,19.502 FL,19.502 FLL F23, F21, F22	02.90 - 06.96		8916.40.00	KZIZ - 5		
19.502 FS,19.502 FLS,19.502 FLLS F23, F21, F22	02.90 - 06.96		4000.90.01 $\Delta \nabla \text{HD}$	400 10	- Engine code: D2840LF,01,04	
22.362 F05,06,07,08,16	01.86 -		4001.10.00	MFZ2/400X		
22.422 F05,06,07,08,16	01.89 -		4010.30.00	400WGVZ		
22.462 F25,28	01.89 -		8916.40.00	KZIZ - 5		
22.502 F25,28,36	01.90 -					
25.362 F05,06,07,08,16	01.86 -		4011.30.00	400 6	- Engine code: D2840LF,01,04	
25.462 F25,28	01.89 -			400GVZ		
32.462 F29,30	01.88 -					
32.502 F29,30	01.90 -					
22.242 F05,06,07,08,16	01.88 -	D 2865 LF	4000.90.01 $\Delta \nabla \text{HD}$	400 10		
22.262 F05,06,07,08,16	01.88 -	D 2866 LF	4001.10.00	MFZ2/400X		
22.272 F05,06,07,08,16	01.90 -		4010.30.00	400WGVZ		
25.242 F05,06,07,08,16	01.88 -		8916.40.00	KZIZ - 5		
			4008.30.00	400 10		
			8916.40.00	400 WGVZ		
			4011.30.00	400 6		
				400GVZ		
22.292 F05,06,07,08,16	01.86 -	D 2866 LF08	4300.90.051	430 10	- Engine code: D2866LF07,08	
22.332 F05,06,07,08,16	01.86 -	D 2866 LF/290	4301.20.00	MFZ430		
22.372 F05,06,07,08,16	01.89 -	D 2866 LF/330	43461.30.00	430WGTZ		
24.292 DF F08	04.87 - 02.90	D 2866 LF01	8916.40.00	KZIZ - 5		
24.292 DFK F08	04.87 - 02.90	D 2866 LF03	4000.90.01 $\Delta \nabla \text{HD}$	400 10	- Engine code: D2866LF07,08	
24.292 DFS,24.292 DFLS F08, F16	04.87 - 02.90	D 2866 LF05	4001.10.00	MFZ2/400X		
24.292 FNL,24.292 FNLL,24.292 FVL F07, F05, F06	10.86 - 02.90		4010.30.00	400WGVZ		
	10.86 - 02.90		8916.40.00	KZIZ - 5		
24.292 FNLS,24.292 FVLS F07, F05	10.86 - 02.90		4009.30.00	400 10	- Engine code: D2866LF07,08	
	10.86 - 02.90		8916.40.00	400WGVZ	- Engine code: D2866LF07,08	
	10.86 - 02.90		4011.30.00	400 6	- Engine code: D2866LF07,08	
	10.86 - 02.90			400GVZ		
24.332 DF F08	04.87 - 02.90					
24.332 DFK F08	04.87 - 02.90					
24.332 DFS,24.332 DFLS F08, F16	04.87 - 02.90					
24.332 FNL,24.332 FNLL,24.332 FVL F07, F05, F06	10.86 - 02.90					
	10.86 - 02.90					
24.332 FNLS,24.332 FVLS F07, F05	10.86 - 02.90					
	10.86 - 02.90					
25.332 F05,06,07,08,16	01.86 -					
26.332 DF, 26.332 DFL F09	09.87 - 02.90					

Vehicle list

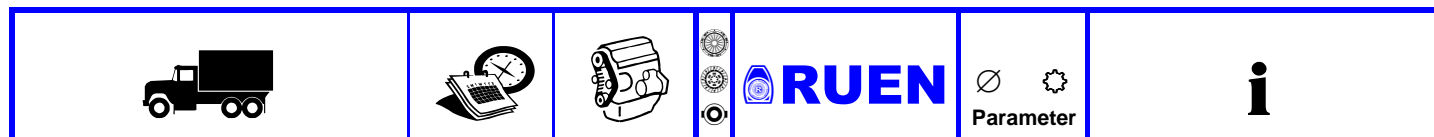

MAN

F 90 06.86 - 12.97

22.302 F05,06,07,08,16 22.322 F05,06,07,08,16	01.90 - 12.92 01.89 -	D 2865 LF03 D 2865 LF06 D 2866 LF04	4000.90.01 $\Delta \nabla \text{HD}$ 400 10 MFZ2/400X 400WGVZ KZIZ - 5		
			4001.10.00		
			4010.30.00		
			8916.40.00		
			4009.30.00 400 10 400WGVZ		
			8916.40.00 KZIZ - 5		
			4011.30.00 400 6 400GVZ		
			4009.30.00 400 10 400WGVZ		
23.272 F20 23.322 F20		D 2865 LF02 D 2865 LF04 D 2865 LF05	4300.90.49 430 10 MFZ430 430WGTZ KZIZ - 5	- From model year: 07/1993	
			4301.20.00	- From model year: 01/1992 - To model year: 06/1993	
			4346.30.00		
			8916.40.00 KZIZ - 5	- From model year: 01/1992 - To model year: 06/1993	
24.242 DF F08 24.242 DFK F08 24.242 DFS F08 24.242 FNL,24.242 FNLL,24.242 FVL F07, F05, F06 24.242 FNL,24.242 FNLL,24.242 FVL F07, F05, F06	01.88 - 07.89	D 2866 F/240	4000.90.01 $\Delta \nabla \text{HD}$ 400 10 MFZ2/400X 400WGVZ KZIZ - 5	- Engine code: D2866F	
			4001.10.00		
	01.88 - 07.89			4010.30.00	- Engine code: D2866F
	01.88 - 07.89			8916.40.00 KZIZ - 5	- Engine code: D2866F
	01.88 - 02.90			4008.30.00 400 10 400 WGVZ	- Engine code: D2866F
	01.88 - 02.90			8916.40.00 KZIZ - 5	- Engine code: D2866F
24.272 DF F08 24.272 DFK F08 24.272 DFS,24.272 DFLS F08, F16 24.272 FNL,24.272 FNLL,24.272 FVL F07, F18, F05, F06, F19	02.90 - 12.90	D 2865 LF02 D 2865 LF05	4000.90.01 $\Delta \nabla \text{HD}$ 400 10 MFZ2/400X 400WGVZ KZIZ - 5	- Engine code: D2865LF01,02,04,05	
	02.90 - 12.90		4001.10.00		
24.272 FNL,24.272 FNLL,24.272 FVL F07, F18, F05, F06, F19	02.90 - 04.95		4010.30.00	- Engine code: D2865LF01,02,04,05	
	02.90 - 05.95		8916.40.00 KZIZ - 5	- Engine code: D2865LF01,02,04,05	
	02.90 - 05.95		4008.30.00 400 10 400 WGVZ	- Engine code: D2865LF01,02,04,05	
	02.90 - 05.95		8916.40.00 KZIZ - 5	- Engine code: D2865LF01,02,04,05	
24.272 FNLS,24.272 FVLS F07, F18, F05	02.90 - 05.95		4009.30.00 400 10 400WGVZ	- Engine code: D2865LF01,02,04,05	
	02.90 - 05.95		4286.30.00 420 10 420WGTZ	- From model year: 07/1990 - Engine code: D2865	
25.272 FNL,25.272 FNLL,25.272 FVL F07, F05, F06	09.90 - 10.93		4011.30.00 400 6 400GVZ	- Engine code: D2865LF01,02,04,05	
	09.90 - 10.93		4011.30.00 400 6 400GVZ	- Engine code: D2865LF01,02,04,05	
19.372 F,19.372 FL,19.372 FLL F02, F03, F01 19.372 FK F01 19.372 FS,19.372 FLS,19.372 FLLS F02, F03, F01 24.372 DF F08 24.372 DFK F08 24.372 DFS F08 25.372 DFK F08 25.372 DFS F08 25.372 FNLS,25.372 FVLS F07, F05 25.372 FVLS F07 26.292 DF, 26.292 DFL F09 26.372 FNL,26.372 FNLL,26.372 FVL F07, F18, F19 26.372 FNLS,26.372 FVLS F07, F18	05.90 - 04.95	D 2866 LF/290 D 2866 LF03 D 2866 LF05 D 2866 LF15 D 2866 LXF	4300.90.051 430 10 MFZ430 430WGTZ KZIZ - 5		
	05.90 - 04.95		4301.20.00		
	05.90 - 04.95		43461.30.00		
	05.90 - 04.95		8916.40.00		
	05.90 - 12.90		4000.90.01 $\Delta \nabla \text{HD}$ 400 10 MFZ2/400X 400WGVZ KZIZ - 5		
	05.90 - 12.90		4001.10.00		
	05.90 - 12.90		4010.30.00		
	05.90 - 12.90		8916.40.00		
	09.90 - 12.92		4009.30.00 400 10 400WGVZ		
	09.90 - 12.92		8916.40.00 KZIZ - 5		
	09.90 - 12.92		4286.30.00 420 10 420WGTZ	- For PTO	
	09.90 - 12.92		4011.30.00 400 6 400GVZ		

Vehicle list



MAN

F 90 06.86 - 12.97

19.462 F, 19.462 FL F02, F01 19.462 FK F01 19.462 FS, 19.462 FLS F02, F01	05.87 - 02.90	D 2840 LF/460	4300.90.051	430 10 MFZ430 430WGTZ KZIZ - 5	- To model year: 07/1989 - Engine code: D2840LF						
	05.87 - 02.90		4301.20.00								
	05.87 - 02.90		43461.30.00								
			8916.40.00								
			4000.90.01 $\Delta \nabla$ HD	400 10 MFZ2/400X 400WGVZ KZIZ - 5	- From model year: 08/1989 - Engine code: D2840LF						
			4001.10.00								
			4010.30.00								
			8916.40.00								
			4286.30.00	420 10 420WGTZ	- Engine code: D2840 - For PTO						
			4011.30.00			400 6 400GVZ	- From model year: 08/1989 - Engine code: D2840LF				
24.302 DF F08 24.302 DFK F08 24.302 DFS, 24.302 DFSL F08, F16 24.302 FNL, 24.302 FNLL, 24.302 FVL F07, F05, F06 25.302 FNLS, 25.302 FVLS F07, F05 25.322 FNLS, 25.322 FVLS F07, F05 26.302 FNLS, 26.302 FVLS F07, F18 26.322 FNLS, 26.322 FVLS F07, F18	05.90 - 12.90	D 2865 LF03 D 2865 LF06 D 2866 LF04	4000.90.01 $\Delta \nabla$ HD	400 10 MFZ2/400X 400WGVZ KZIZ - 5	- Engine code: D2866LF04						
	05.90 - 12.90		4001.10.00								
	05.90 - 04.95		4010.30.00								
	05.90 - 10.90		8916.40.00								
	05.90 - 10.90		4009.30.00			400 10 400WGVZ	- Engine code: D2866LF04				
	09.90 - 12.91		8916.40.00					KZIZ - 5	- Engine code: D2866LF04		
	01.90 - 12.92		4286.30.00							420 10 420WGTZ	- From model year: 07/1990 - Engine code: D2866 - For PTO
	09.90 - 12.91		4011.30.00								
09.90 - 12.95											
24.322 F20		D 2865 LF03	4300.90.49	430 10 MFZ430 430WGTZ KZIZ - 5	- Engine code: D2865LF03,06 - From model year: 07/1993						
			4301.20.00								
			4346.30.00								
			8916.40.00								
			4000.90.01 $\Delta \nabla$ HD			400 10 MFZ2/400X 400WGVZ KZIZ - 5	- Engine code: D2865LF03 - From model year: 01/1992 - To model year: 06/1993				
	4001.10.00										
	4010.30.00										
	8916.40.00										
	4009.30.00	400 10 400WGVZ	- Engine code: D2865LF03 - From model year: 01/1992 - To model year: 06/1993								
	8916.40.00			KZIZ - 5	- Engine code: D2865LF03 - From model year: 01/1992 - To model year: 06/1993						
			4011.30.00	400 6 400GVZ	- Engine code: D2865LF03 - From model year: 01/1992 - To model year: 06/1993						

Vehicle list



MAN

F 90 06.86 - 12.97

24.372 FNL,24.372 FNLL,24.372 FVLF07, F18, F05, F06, F19	02.90 - 04.95	2866 LFZ/330		4300.90.051	430 10	
24.372 FNLS,24.372 FVLSF07, F18, F05	02.90 - 05.95	D 2866 LF03		4301.20.00	MFZ430	
26.402 FNL,26.402 FNLL,26.402 FVL F07, F18, F19	05.94 - 06.96	D 2866 LF04		43461.30.00	430WGTZ	
26.402 FNLS,26.402 FVLS F07, F18	05.94 - 06.96	D 2866 LF06		8916.40.00	KZIZ - 5	
33.402 DFK F09	05.94 - 06.96	D 2866 LF09		4000.90.01 $\Delta \nabla \text{HD}$	400 10	
33.402 DFS F09	05.94 - 06.96	D 2866 LF15		4001.10.00	MFZ2/400X	
33.422 DF F09	05.94 - 06.96	D 2866 LF16		4010.30.00	400WGVZ	
33.422 DFK F09	05.94 - 06.96	D 2866 LXF		8916.40.00	KZIZ - 5	
33.422 DFS F09	09.91 - 06.96			4009.30.00	400 10	
33.422 DFK F09	01.94 - 06.96			8916.40.00	400WGVZ	
33.422 DFS F09	01.94 - 06.96			43461.30.00	430 10	- For PTO
35.302 VFA E15	05.90 - 09.91			43461.30.00	430WGTZ	
35.302 VFAK E15	05.90 - 09.91			8950.40.00	KZIZ-6	- For PTO
35.332 VF F14	10.88 - 04.95					
35.332 VFK F14	10.88 - 04.95					
35.362 VF F14	10.88 - 02.90					
35.362 VFK F14	10.88 - 02.90					
35.372 VFK F14	02.90 - 04.95					
26.332	07.90 -	D 2865 LF		4286.30.00	420 10	- For PTO
26.362	07.90 -	D 2866 LF			420WGTZ	
36.262	01.91 -					
36.272	01.91 -					
36.292	01.91 -					
36.332	01.91 -					
28.242 F09	01.87 - 12.92	D 2866 LF		4008.30.00	400 10	- Engine code: D2865LF
28.262 F09,13,14	01.87 -	D 2865 LF/260			400 WGVZ	
32.272 VF F13	02.90 - 04.95	D 2865 LF02		8916.40.00	KZIZ - 5	- Engine code: D2865LF
32.272 VFK F13	02.90 - 04.95	D 2865 LF05		4286.30.00	420 10	- Engine code: D2865LF
33.262 DF F09	08.88 - 02.90				420WGTZ	
33.262 DFA F10	07.89 - 02.90					
33.262 DFAK F10	07.89 - 02.90					
33.262 DFK F09	08.88 - 02.90					
33.272 F13,14	01.90 -					
35.262 VF F14	02.89 - 02.90					
35.262 VFA F14	07.89 - 02.90					
35.262 VFK F14	02.89 - 02.90					
35.272 VF F14	02.90 - 12.91					
35.272 VFK F14	02.90 - 12.92					
41.262 VF F14	07.89 - 02.90	D 2865 LF/260		4009.30.00	400 10	
41.262 VFK F14	07.89 - 02.90			8916.40.00	400WGVZ	
				8916.40.00	KZIZ - 5	
				4286.30.00	420 10	- For PTO
					420WGTZ	

Vehicle list



MAN

F 90 06.86 - 12.97

19.262 F, 19.262 FL, 19.262 FLL F02, F03, F01	01.88 - 02.90	D 2865 LF/260	4008.30.00	400 10 400 WGVZ	- Engine code: D2865LF
19.262 FA F04	02.89 - 02.90	D 2865 LF02	4009.30.00	400 10 400WGVZ	- Engine code: D2865LF
19.262 FAK F04	02.89 - 02.90	D 2865 LF05	8916.40.00	KZIZ - 5	- Engine code: D2865LF
19.262 FAS F04	02.89 - 02.90		4286.30.00	420 10 420WGTZ	- Engine code: D2865
19.262 FK F01	01.88 - 02.90				
19.262 FS, 19.262 FLS, 19.262 FLLS F02, F03, F01	01.88 - 02.90				
19.272 F, 19.272 FL, 19.272 FLL F02, F03, F01	02.90 - 05.95				
19.272 FA F04	02.90 - 05.95				
19.272 FAK F04	02.90 - 05.95				
19.272 FAS F04	02.90 - 05.95				
19.272 FK F01	02.90 - 05.95				
19.272 FS, 19.272 FLS, 19.272 FLLS F02, F03, F01	02.90 - 05.95				
19.362 F, 19.362 FL, 19.362 FLL F02, F03, F01	07.86 - 02.90	D 2866 KF	4300.90.051	430 10 MFZ430	- Engine code: D2866KF
19.362 FA F04	05.88 - 02.90	D 2866 LXF	4301.20.00	430WGTZ	
19.362 FAK F04	05.88 - 02.90		43461.30.00	KZIZ - 5	
19.362 FAS F04	05.88 - 02.90		8916.40.00	KZIZ - 5	
			4008.30.00	400 10 400 WGVZ	- Engine code: D2865LF
			4009.30.00	400 10 400WGVZ	- Engine code: D2865LF
			8916.40.00	KZIZ - 5	- Engine code: D2865LF
			4286.30.00	420 10 420WGTZ	- Engine code: D2865, D2866
24.262 DF F08	01.88 - 02.90	D 2865 LF/260	4000.90.01 $\Delta \nabla \text{HD}$	400 10 MFZ2/400X	- Engine code: D2865LF
24.262 DFK F08	01.88 - 02.90		4001.10.00	400WGVZ	
24.262 DFS, 24.262 DFLLS F08, F16	01.88 - 02.90		4010.30.00	KZIZ - 5	
24.262 FNL, 24.262 FNLL, 24.262 FVL F07, F05, F06	01.88 - 02.90		8916.40.00	KZIZ - 5	
	01.88 - 02.90		4008.30.00	400 10 400 WGVZ	- Engine code: D2865LF
			4009.30.00	400 10 400WGVZ	- Engine code: D2865LF
			8916.40.00	KZIZ - 5	- Engine code: D2865LF
			4011.30.00	400 6 400GVZ	- Engine code: D2865LF
24.362 FNL, 24.362 FNLL, 24.362 FVL F07, F05, F06	10.86 - 02.90	D 2866 KF	4300.90.051	430 10 MFZ430	- Engine code: D2866KF, KU, LXF
24.362 FNLS, 24.362 FVLS F07, F05	10.86 - 02.90	D 2866 LXF	4301.20.00	430WGTZ	
	10.86 - 02.90		43461.30.00	KZIZ - 5	
			8916.40.00	KZIZ - 5	
			4000.90.01 $\Delta \nabla \text{HD}$	400 10 MFZ2/400X	- Engine code: D2866KF, KU, LXF
			4001.10.00	400WGVZ	
			4010.30.00	KZIZ - 5	
			8916.40.00	KZIZ - 5	
			4286.30.00	420 10 420WGTZ	- Engine code: D2866 - For PTO
			4011.30.00	400 6 400GVZ	- Engine code: D2866KF, KU, LXF

Vehicle list



MAN

F 90 06.86 - 12.97

24.422 FNL, 24.422 FNLL, 24.422 FVL F07, F18, F05, F19, F06 25.422 FNLS, 25.422 FVLS F07, F05 26.422 FNL, 26.422 FNLL, 26.422 FVL F07, F18, F19 26.422 FNLS, 26.422 FVLS F07, F18	02.90 - 05.95	D 2866 LF06 D 2866 LF09		4300.90.051 4301.20.00 4346.30.00 8916.40.00	430 10 MFZ430 430WGTZ KZIZ - 5	- Engine code: D2866LF06,09
	09.90 - 12.92			4000.90.01 $\Delta \nabla \text{HD}$ 4001.10.00 4010.30.00 8916.40.00	400 10 MFZ2/400X 400WGVZ KZIZ - 5	- Engine code: D2866LF06,09
	09.90 - 12.95			4286.30.00	420 10 420WGTZ	- From model year: 07/1990 - Engine code: D2866 - For PTO
	01.92 - 12.95			4011.30.00	400 6 400GVZ	- Engine code: D2866LF06,09
16.262 F01,02,03 16.272 F01,02,03	01.85 - 12.92			4008.30.00	400 10 400 WGVZ	- Engine code: D2865LF01/02/04/05
	01.90 -			8916.40.00	KZIZ - 5	- Engine code: D2865LF01/02/04/05
24.322 DF F08 24.322 DFK F08 24.322 DFS, 24.322 DFSL F08, F16 24.322 FNL, 24.322 FNLL, 24.322 FVL F07, F18, F05, F06, F19 24.322 FNLS, 24.322 FVLS F07, F18, F05	02.90 - 12.90	D 2865 LF03 D 2865 LF06 D 2866 LF03		4000.90.01 $\Delta \nabla \text{HD}$ 4001.10.00 4010.30.00 8916.40.00	400 10 MFZ2/400X 400WGVZ KZIZ - 5	- Engine code: D2865LF03,06
	02.90 - 12.90			4009.30.00	400 10 400WGVZ	- Engine code: D2865LF03,06
	02.90 - 05.95			8916.40.00	KZIZ - 5	- Engine code: D2865LF03,06
	02.90 - 05.95			4286.30.00	420 10 420WGTZ	- From model year: 07/1990 - Engine code: D2865 - For PTO
02.90 - 05.95			4011.30.00	400 6 400GVZ	- Engine code: D2865LF03,06	

F 90 Unterflur 06.86 - 09.96























































16.332 U01,03 16.372 22.332 U05,06 25.332 U05,06 26.332 U05,06	01.86 - 12.92			4300.90.05 4301.20.00 4346.30.00 8916.40.00	430 10 MFZ430 430WGTZ KZIZ - 5	
	01.86 - 12.92			4300.90.49 4301.20.00 4346.30.00 8916.40.00	430 10 MFZ430 430WGTZ KZIZ - 5	
	01.86 - 12.92			43460.30.00	430 10 430WGTZ	- From model year: 08/1993 - Engine code: D2865LF03,06
	01.86 - 12.92			4300.90.05 4301.20.00 4346.30.00 8916.40.00	430 10 MFZ430 430WGTZ KZIZ - 5	
19.322 U, 19.322 UL, 19.322 ULL U11, U13	02.90 - 05.94	D 2865 LF03) D 2865 LF06		4300.90.05 4301.20.00 4346.30.00 8916.40.00	430 10 MFZ430 430WGTZ KZIZ - 5	
19.332 U, 19.322 UL, 19.322 ULL U01, U03	07.86 - 02.90	D 2866 LUL/330		4300.90.05 4301.20.00 4346.30.00 8916.40.00	430 10 MFZ430 430WGTZ KZIZ - 5	
19.362 U, 19.362 UL, 19.362 ULL U01, U03	07.86 - 01.91	D 2866 KUL		4300.90.05 4301.20.00 4346.30.00 8916.40.00	430 10 MFZ430 430WGTZ KZIZ - 5	
19.372 U, 19.372 ULL U11, U13	02.90 - 05.94	D 2866 LF03 D 2866 LF05		4300.90.05 4301.20.00 4346.30.00 8916.40.00	430 10 MFZ430 430WGTZ KZIZ - 5	
19.422 U, 19.422 ULL U11, U13	02.90 - 05.94	D 2866 LF06 D 2866 LF09		4300.90.05 4301.20.00 4346.30.00 8916.40.00	430 10 MFZ430 430WGTZ KZIZ - 5	

Vehicle list

					
---	---	---	--	---	---

MAN

F 90 Unterflur 06.86 - 09.96

22.362 U05,06,16 25.362 U05,06,16 26.362 U05,06,16	01.86 - 01.86 - 01.86 -		   	4300.90.05 4301.20.00 4346.30.00 8916.40.00	430 10 MFZ430 430WGTZ KZIZ - 5	
22.372	01.90 -		   	4300.90.05 4301.20.00 4346.30.00 8916.40.00	430 10 MFZ430 430WGTZ KZIZ - 5	
22.422 U15	01.89 -		   	4300.90.05 4301.20.00 4346.30.00 8916.40.00	430 10 MFZ430 430WGTZ KZIZ - 5	
23.362 U07	01.88 -		   	4300.90.05 4301.20.00 4346.30.00 8916.40.00	430 10 MFZ430 430WGTZ KZIZ - 5	
24.332 UNL,24.332 UNLL U05, U06, U07	10.86 - 02.90	D 2866 LUL/330	   	4300.90.05 4301.20.00 4346.30.00 8916.40.00	430 10 MFZ430 430WGTZ KZIZ - 5	
24.362 UNL,24.362 UNLL U07, U05, U06	10.86 - 02.90	D 2866 KUL	   	4300.90.05 4301.20.00 4346.30.00 8916.40.00	430 10 MFZ430 430WGTZ KZIZ - 5	
24.372 UNL,24.372 UNLL U07, U16, U15	02.90 - 12.90	D 2866 LF03	   	4300.90.05 4301.20.00 4346.30.00 8916.40.00	430 10 MFZ430 430WGTZ KZIZ - 5	
24.422 UNL,24.422 UNLL U07, U16, U15	02.90 - 12.90	D 2866 LF06	   	4300.90.05 4301.20.00 4346.30.00 8916.40.00	430 10 MFZ430 430WGTZ KZIZ - 5	
25.372 UNL,25.372 UNLL U16, U07, U15	09.90 - 12.92	D 2866 LF03 D 2866 LF05	   	4300.90.05 4301.20.00 4346.30.00 8916.40.00	430 10 MFZ430 430WGTZ KZIZ - 5	
25.422 UNL,25.422 UNLL U07, U16, U15	09.90 - 12.92	D 2866 LF06 D 2866 LF09	   	4300.90.05 4301.20.00 4346.30.00 8916.40.00	430 10 MFZ430 430WGTZ KZIZ - 5	
26.372 UNL,26.372 UNLL U16, U15	09.90 - 05.94	D 2866 LF03 D 2866 LF05	   	4300.90.05 4301.20.00 4346.30.00 8916.40.00	430 10 MFZ430 430WGTZ KZIZ - 5	
26.422 UNL,26.422 UNLL U16, U15	09.90 - 05.94	D 2866 LF06) D 2866 LF09	   	4300.90.05 4301.20.00 4346.30.00 8916.40.00	430 10 MFZ430 430WGTZ KZIZ - 5	
14.262 U20 14.272 U20 17.262 U20 17.272 U20	01.89 - 12.94 01.90 - 12.94 01.89 - 12.94 01.90 - 12.94		   	4008.30.00 4009.30.00 8916.40.00	400 10 400 WGVZ 400 10 400WGVZ KZIZ - 5	- Engine code: D2865LF - Transmission type: ZF - Engine code: D2865LF - Transmission type: Fuller - Engine code: D2865LF
22.322 U15	01.89 -		 	4009.30.00 8916.40.00	400 10 400WGVZ KZIZ - 5	- Engine code: D2865LF03,06

Vehicle list

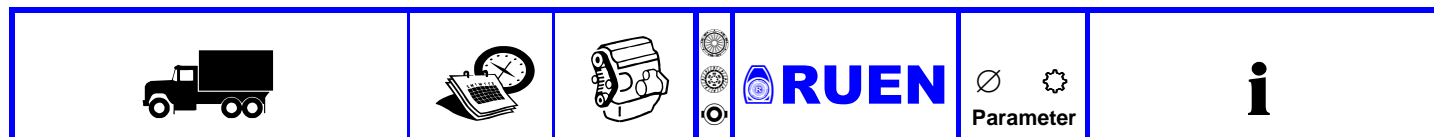

MAN

F 90 Unterflur 06.86 - 09.96

24.322 UNL, 24.322 UNLL U16, U15	02.90 - 12.90	D 2865 LF03		4009.30.00	400 10 400WGVZ	- Engine code: D2865LF03
25.322 UNL, 25.322 UNLL U16, U15	09.90 - 12.92	D 2865 LF06		8916.40.00	KZIZ - 5	- Engine code: D2865LF03
26.322 UNL, 26.322 UNLL U16, U15	09.90 - 05.94			4286.30.00	420 10 420WGTZ	- From model year: 07/1990 - Engine code: D2865 - For PTO

G 10.79 - 08.88

6.90 F 560	10.79 - 09.87	D 0224 MF		2835.20.00	280 MFZ280	
6.90 FK 560	10.79 - 09.87	D 0226 MF		3180.20.00	310 GMFZ310KR	
8.90 F 560	10.79 - 09.87					
8.90 FK 560	10.79 - 09.87					
8.136 F, 8.136 FL 561	10.79 - 09.87					
8.136 FK 561	10.79 - 08.88					
8.136 FA, FAR 565	05.83 - 05.90	D 0226 MF		3180.20.00	310 GMFZ310KR	
8.136 FAE 565	12.83 - 08.88					
9.136 FA, FAR 565	05.83 - 05.90					
9.136 FAE 565	12.83 - 08.88					
9.136 F, 9.136 FL 561	10.79 - 09.87	D 0226 MF		2835.20.00	280 MFZ280	
9.136 FK 561	10.79 - 08.88					
10.136 F, 10.136 FL 491, 562	09.81 - 09.87	D 0226 MF		3180.20.00	310 GMFZ310KR	
10.136 FK 491	09.81 - 09.87					
8.136 FOC 563	03.82 - 07.88	D 0226 MF		2835.20.00	280 MFZ280	- Engine code: D0226
9.136 FOC 563	03.82 - 07.88			3184.20.00	310 MFZ310	- Engine code: D0226
				3573.20.00	350 MF350	- Engine code: D0226
				3563.30.00	350 10 350GSZ	- Engine code: D0226
				6905.40.00	KZIS - 3	- Engine code: D0226

G 90 09.87 - 05.95

6.100 F L01	09.87 - 10.93	D 0824 GF		2835.20.00	280 MFZ280	
6.100 FK L01	09.87 - 10.93	D 0824 GF01		3180.20.00	310 GMFZ310KR	
8.100 F L01	09.87 - 10.93	D 0824 GF02				
8.100 FK L01	09.87 - 10.93					
8.150 F, 8.150 FL L02	09.87 - 10.93	D 0826 GF		3180.20.00	310 GMFZ310KR	
8.150 FAE L03	05.88 - 05.95	D 0826 GF03				
8.150 FK L02	09.87 - 10.93					
8.150 FS, 8.150 FLS L02	09.87 - 10.93					
9.150 F, 9.150 FL L02	09.87 - 10.93					
9.150 FAE L03	05.88 - 05.92					
9.150 FK L02	09.87 - 10.93					
9.150 FS, 9.150 FLS L02	09.87 - 10.93					
8.170 L05	01.88 - 12.94			3573.20.00	350 MF350	
9.170 L05	01.88 - 12.94			3563.30.00	350 10 350GSZ	
				6905.40.00	KZIS - 3	
10.150 F, 10.150 FL L04, 92kW	05.90 - 10.93	D 0226 MF		3180.20.00	310 GMFZ310KR	
10.150 F, 10.150 FL L04, 110kW	09.87 - 10.93	D 0826 GF01				
10.150 FK L04	09.87 - 10.93	D 0826 GF03				
8.150 FOC L05	07.88 - 10.93	D 0226		3184.20.00	310 MFZ310	- Engine code: D0826F,GF
8.170 FOC L05	02.89 - 10.93	MCFO/170				
9.150 FOC L05	07.88 - 10.93	D 0826 GF01				
9.170 FOC L05	02.89 - 10.93	D 0826 GF03				

Vehicle list



MAN

L 2000		10.93 -				
6.103 L20, L33	01.93 -			3300.90.08	330 10	- From model year: 03.1996
6.153 L20, L33	01.93 -			3313.20.00	MFZ330	
6.163 L20	01.93 -			3309.30.00	330GSZ	
7.153 L20, L33	01.93 -			3620.90.10	362 10	
7.163 L20	01.93 -			3610.20.00	MFZ362	
				3610.30.00	362GTZ	
6.103 L L20	05.93 -	D 0824 LFL 02		3300.90.08	330 10	
8.163 LAC, LAEC, LARC, LAERC L22	01.95 -	D 0824 LFL 06		3313.20.00	MFZ330	
8.163 LAEC L22, 104kW	08.95 - 03.97	D 0824 LFL 07		3309.30.00	330GSZ	
		D 0824 LFL 09		3620.90.10	362 10	
				3610.20.00	MFZ362	
				3610.30.00	362GTZ	
6.164 L20, L33	01.93 -			3300.90.08	330 10	
7.164 L20, L33	01.93 -			3313.20.00	MFZ330	
8.164 L20,L22,L33	01.93 -			3309.30.00	330GSZ	
9.164 L20,L22,L33	01.93 -			3620.90.10	362 10	
10.164 L35	01.93 -			3610.20.00	MFZ362	
				3610.30.00	362GTZ	
7.103 L20, L33	04.96 -			3620.90.10	362 10	
				3610.20.00	MFZ362	
				3610.30.00	362GTZ	
8.. - 12..				3950.90.02	395 10	- Transmission type: FS 8309
				3956.20.00	MFZ395	
				3951.30.00	395WGTZ	
				8535.40.00	KZIZ - 4,5	
				3620.90.11	362 10	- Transmission type: S 5-42; 6 S850
				3601.20.00	MF362	- Engine code: D 0834 LFL
				3607.30.00	362WGTZ	
				8603.47.00	HHIS-3	
				3620.90.09	362 10	- Transmission type: S 5-42; 6S 850
				3601.20.00	MF362	- Engine code: D 0834 LFL
				3607.30.00	362WGTZ	
8.103 LC,8.103 LLC L20, L33	10.93 - 06.96	D 0824 FL 01		3300.90.08	330 10	- To model year: 03.1996
				3313.20.00	MFZ330	
				3309.30.00	330GSZ	
				3620.90.10	362 10	
				3610.20.00	MFZ362	
				3610.30.00	362GTZ	
8.103 LK L20	10.93 - 06.96	D 0824 FL 01		3300.90.08	330 10	- To model year: 03.1996
				3313.20.00	MFZ330	
				3309.30.00	330GSZ	
				3620.90.10	362 10	
				3610.20.00	MFZ362	
				3610.30.00	362GTZ	
8.113 LC,8.113 LLC L20, L33	08.95 -	D 0824 LFL 04		3300.90.08	330 10	- To model year: 03.1996
				3313.20.00	MFZ330	
				3309.30.00	330GSZ	
				3620.90.10	362 10	
				3610.20.00	MFZ362	
				3610.30.00	362GTZ	

Vehicle list



MAN

L 2000		10.93 -				
8.113 LK, L-KI, LRK, LR-KI, LRK-L, LK-L L20	08.95 -	D 0824 LFL 04	3300.90.08 3313.20.00 3309.30.00	330 10 MFZ330 330GSZ	- To model year: 03.1996	
			3620.90.10 3610.20.00 3610.30.00			362 10 MFZ362 362GTZ
8.113 LC, 8.113 LLC, LRC, LLRC (LE110C) L20, L33	09.00 -	D 0824 LFL 08	3620.90.10 3610.20.00 3610.30.00	362 10 MFZ362 362GTZ		
8.145 LC, LLC, LLRC, LRC (LE140C) L20, L33 9.145 LC, 9.145 LLC, LRC, LLRC (LE140C) L20, L33	09.00 -	D 0834 LFL 02	3620.90.11 3601.20.00 3607.30.00 8603.47.00	362 10 MF362 362WGTZ HHIS-3	- Engine code: D0834LFL02	
	09.00 -		3620.90.09 3601.20.00 3607.30.00		362 10 MF362 362WGTZ	- Engine code: D0834LFL02
8.145 LK, LRK, L-KI, LRK-L, LK-L, LR-KILK (LE140C) L20 9.145 LK, L-KI, LRK, LR-KI, LRK-L, LK-L (LE140C) L20	09.00 -	D 0834 LFL 02	3620.90.11 3601.20.00 3607.30.00 8603.47.00	362 10 MF362 362WGTZ HHIS-3	- Engine code: D0834LFL02	
	09.00 -		3620.90.09 3601.20.00 3607.30.00		362 10 MF362 362WGTZ	- Engine code: D0834LFL02
8.145 LLS, LLRS (LE140C) L33	09.00 -	D 0834 LFL 02	3620.90.11 3601.20.00 3607.30.00 8603.47.00	362 10 MF362 362WGTZ HHIS-3	- Engine code: D0834LFL02	
			3620.90.09 3601.20.00 3607.30.00		362 10 MF362 362WGTZ	- Engine code: D0834LFL02
8.153 L20, L22, L33	04.96 -		3620.90.10 3610.20.00 3610.30.00	362 10 MFZ362 362GTZ		
8.153 LAEC L22 8.153 LAEK L22	01.95 - 06.96	D 0824 LFL 01	3300.90.08 3313.20.00 3309.30.00	330 10 MFZ330 330GSZ	- To model year: 03.1996	
	01.95 - 09.96	D 0824 LFL 05	3620.90.10 3610.20.00 3610.30.00		362 10 MFZ362 362GTZ	
8.153 LC, 8.153 LLC L20, L33 9.153 LC, 9.153 LLC L20, L33	10.93 - 07.97	D 0824 LFL 01	3300.90.08 3313.20.00 3309.30.00	330 10 MFZ330 330GSZ	- To model year: 03.1996	
	10.93 - 06.96	D 0824 LFL 05	3620.90.10 3610.20.00 3610.30.00		362 10 MFZ362 362GTZ	
8.153 LK L20 9.153 LK L20	10.93 - 07.97	D 0824 LFL 01	3300.90.08 3313.20.00 3309.30.00	330 10 MFZ330 330GSZ	- To model year: 03.1996	
	10.93 - 06.96	D 0824 LFL 05	3620.90.10 3610.20.00 3610.30.00		362 10 MFZ362 362GTZ	

Vehicle list



MAN

L 2000 10.93 -

8.153 LLS L33	10.93 - 06.96	D 0824 LFL 01 D 0824 LFL 05	3300.90.08 3313.20.00 3309.30.00	330 10 MFZ330 330GSZ	- To model year: 03.1996
			3620.90.10 3610.20.00 3610.30.00	362 10 MFZ362 362GTZ	
8.160 L50, L51	01.94 -		3300.90.08 3313.20.00 3309.30.00	330 10 MFZ330 330GSZ	
			3620.90.10 3610.20.00 3610.30.00	362 10 MFZ362 362GTZ	
8.163 LC,8.163 LLC, LRC, LLRC, L-LF L20, L33, 104kW	08.95 -	D 0824 LFL 07	3300.90.08 3313.20.00 3309.30.00	330 10 MFZ330 330GSZ	- To model year: 03.1996
			3620.90.10 3610.20.00 3610.30.00	362 10 MFZ362 362GTZ	
8.163 LC,8.163 LLC L20, L33, 114kW 9.163 LC,9.163 LLC, LRC, LLRC L20, L33	05.94 -	D 0824 LFL 02 D 0824 LFL 06 D 0824 LFL 09	3300.90.08 3313.20.00 3309.30.00	330 10 MFZ330 330GSZ	- To model year: 03.1996
	05.94 -		3620.90.10 3610.20.00 3610.30.00	362 10 MFZ362 362GTZ	
8.163 LC, LLC, LLRC, LRC (LE160C) L20, L33	09.00 -	D 0824 LFL 09	3620.90.10 3610.20.00 3610.30.00	362 10 MFZ362 362GTZ	
8.163 LK, L-KI, LRK, LR-KI, LRK-L, LK-L L20 9.163 LK, L-KI, LRK, LR-KI, LRK-L, LK-L L20, 114kW	05.94 -	D 0824 LFL 02 D 0824 LFL 06 D 0824 LFL 09	3300.90.08 3313.20.00 3309.30.00	330 10 MFZ330 330GSZ	- To model year: 03.1996
	05.94 -		3620.90.10 3610.20.00 3610.30.00	362 10 MFZ362 362GTZ	
8.163 LLS,LLRS L33 9.163 LLS, LLRSL33	05.94 -	D 0824 LFL 02 D 0824 LFL 06 D 0824 LFL 09	3300.90.08 3313.20.00 3309.30.00	330 10 MFZ330 330GSZ	- To model year: 03.1996
	05.94 -		3620.90.10 3610.20.00 3610.30.00	362 10 MFZ362 362GTZ	

Vehicle list

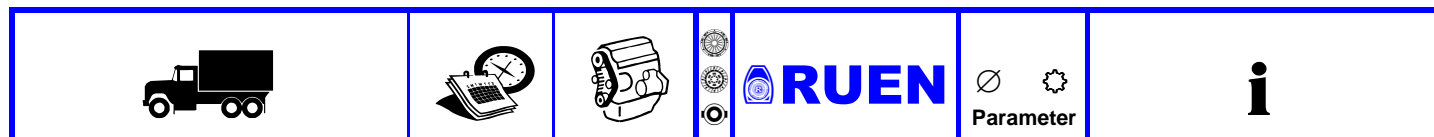

MAN

L 2000		10.93 -				
8.185 LAC, LAEC, LARC, LAERC, LA-LF, LAE-LF (LE180C) L22	09.00 -	D 0834 LFL 02		3620.90.11	362 10	
8.185 LAEK, LAEK-L, LAERK, LAERK-L, LAK, LAK-L, LARK, LARK-L L22	09.00 -	D 0834 LFL 03		3601.20.00	MF362	
		D 0836 LFL 02		3607.30.00	362WGTZ	
				8603.47.00	HHIS-3	
8.225 LAC, LAEC, LARC, LAERC (LE220C) L23	09.00 -			3620.90.09	362 10	
8.225 LAEK, LAEK-L, LAERK, LAERK-L, LAK, LAK-L, LARK, LARK-L L23	09.00 -			3601.20.00	MF362	
				3607.30.00	362WGTZ	
8.225 LLS, LLRS (LE220C) L34	09.00 -					
9.225 LLS, LLRS (LE220C) L34	09.00 -					
10.145 LC, 10.145 LLC, LRC, LLRC (LE140C) L20, L33	09.00 -					
10.145 LK, L-KI, LRK, LR-KI, LRK-L, LK-L (LE140C) L24	09.00 -					
10.145 LLS, LLRS (LE140C) L35	09.00 -					
10.185 LAC, LAEC, LARC, LAERC, LA-LA (LE180C) L26	09.00 -					
10.185 LAEK, LAEK-L, LAERK, LAERK-L, LAK, LAK-L, LARK L26	09.00 -					
10.185 LC, 10.185 LLC, LRC, LLRC (LE180C)L35, L24	09.00 -					
10.185 LK, L-KI, LRK, LR-KI, LRK-L, LK-L (LE180C) L24	09.00 -					
10.185 LLS, LLRS (LE180C) L35	09.00 -					
10.225 LAC, LAEC, LARC, LAERC (LE220C) L27	09.00 -					
10.225 LAEK, LAEK-L, LAERK, LAERK-L, LAK, LAK-L, LARK L27	09.00 -					
10.225 LC, 10.225 LLC, LRC, LLRC (LE220C) L25, L36	09.00 -					
10.225 LK, L-KI, LRK, LR-KI, LRK-L, LK-L (LE220C)L25	09.00 -					
10.225 LLS, LLRS (LE220C) L36	09.00 -					
12.185 LC, LLC (LE180C) L72, L70	09.99 -					
12.225 LC, LLC (LE220C) L71, L73	09.99 -					
8.185 LC, LLC, LRC, LLRC (LE180C) (LE180C) L20, L33	09.00 -	D 0834 LFL 03		3601.20.00	362	
				3607.30.00	MF362	
9.185 LC, 9.185 LLC, LRC, LLRC (LE180C) L20, L33	09.00 -			3607.30.00	362 10	
				3607.30.00	362WGTZ	
8.185 LK, L-KI, LRK, LR-KI LRK-L, LK-L (LE180C) L20	09.00 -	D 0834 LFL 03		3601.20.00	362	
				3607.30.00	MF362	
9.185 LK, L-KI, LRK, LR-KI, LRK-L, LK-L (LE180C) L20	09.00 -			3607.30.00	362 10	
				3607.30.00	362WGTZ	
8.185 LLS, LLRS (LE180C) L33	09.00 -	D 0834 LFL 03		3601.20.00	362	
				3607.30.00	MF362	
9.185 LLS, LLRS (LE 180C) L33	09.00 -			3607.30.00	362 10	
				3607.30.00	362WGTZ	
8.223 LC, 8.223 LLC L21, L34	10.93 - 06.96	D 0826 LFL02		3500.90.04	350 10	- To model year: 02.1994
8.223 LK L21	10.93 - 06.96	D 0826 LFL06		3573.20.00	MF350	
9.223 LC, 9.223 LLC L21, L34	10.93 - 06.96			3587.30.00	350GSZ	
				6905.40.00	KZIS - 3	
9.223 LK L21	10.93 - 06.96			3573.20.00	350	- From model year: 03.1994
				3596.30.00	MF350	
				3596.30.00	350 10	
				6905.40.00	350WGSZ	
				6905.40.00	KZIS - 3	- From model year: 03.1994

Vehicle list



MAN

L 2000 10.93 -

8.223 LAEC L23	01.95 - 06.96	D 0826 LFL03	3573.20.00	350 MF350	
8.224 LAC, LAEC, LARC, LAERC L23	01.95 -	D 0826 LFL06	3596.30.00	350 10 350WGSZ	
8.224 LAK, LAEK, LARK, LAERK L23	01.95 -		6905.40.00	KZIS - 3	
8.224 LC,8.224 LLC, LRC, LLRC L21, L34	05.94 -				
8.224 LK, LRK, L-KI, LR-KI L21	05.94 -				
8.224 LLS, LLRS L34	05.94 -				
9.224 LC,9.224 LLC, LRC, LLRC L21, L34	05.94 -				
9.224 LK, L-KI, LRK, LR-KI, LRK-L, LK-L L21	05.94 -				
9.224 LLS, LLRS L34	05.94 -				
8.223 LLS L34	10.93 - 06.96	D 0826 LFL02	3500.90.04	350 10 MF350	- To model year: 02.1994
9.223 LLS L34	10.93 - 06.96	D 0826 LFL06	3573.20.00 3587.30.00 6905.40.00	350GSZ KZIS - 3	
			3596.30.00	350 10 350WGSZ	- From model year: 03.1994
8.224 L21, L34	01.93 - 02.94		3500.90.04	350 10 MF350	
9.224 L21, L34	01.93 - 02.94		3573.20.00 3587.30.00 6905.40.00	350GSZ KZIS - 3	
10.224 L25,36	01.93 - 02.94				
8.225 LC,8.225 LLC, LRC, LLRC (LE220C) L21, L34	09.00 -	D 0826 LFL10	3601.20.00	362 MF362	
8.225 LK, L-KI, LRK, LR-KI, LRK-L, LK-L (LE220C) L21	09.00 -	D 0834 LFL 02	3607.30.00	362 10 362WGTZ	
9.145 LLS, LLRS (LE140C) L33	09.00 -	D 0836 LFL 02			
9.225 LK, L-KI, LRK, LR-KI, LRK-KI, LK-L (LE220C) L21	09.00 -				
9.153 LLS L33	10.93 - 12.95	D 0824 LFL 01	3300.90.08	330 10 MFZ330	
		D 0824 LFL 05	3313.20.00 3309.30.00	330GSZ	
			3620.90.10	362 10 MFZ362	
			3610.20.00 3610.30.00	362GTZ	
9.163 LC L20	08.95 - 03.97	D 0824 LFL 07	3300.90.08	330 10 MFZ330	- To model year: 03.1996
9.163 LK L20, 104kW	08.95 - 03.97		3313.20.00 3309.30.00	330GSZ	
			3620.90.10	362 10 MFZ362	
			3610.20.00 3610.30.00	362GTZ	
9.225 LC,9.225 LLC, LRC, LLRC (LE220C) L20, L33	09.00 -	D 0836 LFL 02	3601.20.00	362 MF362	
			3607.30.00	362 10 362WGTZ	
10.153 LAEK L26	10.93 - 06.96	D 0824 LFL 01	3300.90.08	330 10 MFZ330	- To model year: 03.1996
10.153 LC,10.153 LLC L35, L24	10.93 - 06.96	D 0824 LFL 02	3313.20.00 3309.30.00	330GSZ	
10.153 LK L24	10.93 - 06.96	D 0824 LFL 05			
10.153 LLS L35	10.93 - 06.96	D 0824 LFL 06	3620.90.10	362 10 MFZ362	
10.163 LAC, LAEC, LARC, LAERC L26	05.94 -	D 0824 LFL 09	3610.20.00 3610.30.00	362GTZ	
10.163 LAEK, LAEK-L, LAERK, LAERK-L, LAK, LAK-L, LARK L26	01.95 -				
10.163 LC,10.163 LLC L35, L24	05.94 -				
10.163 LK, L-KI, LRK, LR-KI, LRK-L, LK-L24	05.94 -				
10.163 LLS, LLRS L35	05.94 -				
10.163 LC,10.163 LLC, LRC, LLRC (LE160C) L35, L24	09.00 -	D 0824 LFL 09	3620.90.10	362 10 MFZ362	
			3610.20.00 3610.30.00	362GTZ	

Vehicle list



MAN

L 2000 10.93 -

10.223 LC,10.223 LLC L35, L25, L36 10.223 LK L25 10.223 LLS L35, L36	10.93 - 06.96	D 0826 LFL02	3500.90.04	350 10	- To model year: 02.1994
	10.93 - 06.96	D 0826 LFL06	3573.20.00 3587.30.00 6905.40.00	MF350 350GSZ KZIS - 3	
10.223 LAEC L27 10.224 LAC, LAEC, LARC, LAERC L27 10.224 LAEK, LAEK-L, LAERK, LAERK-L, LAK, LAK-L, LARK L27 10.224 LC,10.224 LLC, LRC, LLRC L35, L25, L36 10.224 LK, L-KI, LRK, LR-KI, LRK-L, LK-L L25 10.224 LLS, LLRS L35, L36	01.95 - 06.96	D 0826 LFL03	3573.20.00	350	- From model year: 03.1994
	01.95 - 05.94	D 0826 LFL06	3596.30.00	350 10	
	05.94 - 05.94		6905.40.00	350WGSZ KZIS - 3	
8.113 LK, L-KI, LRK, LR-KI, LRK-L, LK-L L20 8.150 FOC,8.150 FOCL L50, L51 8.163 LAC, LAEC, LARC, LAERC, LA-LF, LAE-LF L22	08.95 - 02.95	D 0824 LFL 02 D 0824 LFL 04	3300.90.08 3313.20.00 3309.30.00	330 10	- To model year: 03/1996 - Engine code: D0824, LFL04, FL
	01.95 - 01.95	D 0824 LFL 06 D 0824 LFL 09	3620.90.10 3610.20.00 3610.30.00	362 10	- Engine code: D0824, LFL04, FL
		D 0824 LFO	3620.90.30 3610.20.00 3610.30.00 8633.47.00	362 10	- Engine code: D0824, LFL04, FL
				MFZ330 330GSZ MFZ362 362GTZ HHISZ-3	
8.220 FOC,8.220 FOCL L52, L53 10.220 FOC,10.220 FOCL L52, L53	04.95 - 02.95	D 0826 LFL03	3573.20.00	350	- Engine code: D0826
			3591.30.00	350 10	- Engine code: D0826
			6905.40.00	350WGTZ KZIS - 3	- Engine code: D0826
10.150 FOC L50	02.95 - 01.96	D 0824 LFO	3620.90.10 3610.20.00 3610.30.00	362 10	
			3620.90.30 3610.20.00 3610.30.00 8633.47.00	MFZ362 362GTZ HHISZ-3	

M 90 08.88 - 12.98

12.152 F,12.152 FL M01, M02 12.152 FK M01 12.152 FS,12.152 FLS M01, M02	12.88 - 05.94	D 0826 F01	3168.20.00	310	
	12.88 - 05.94	D 0826 F02	3127.30.00	310 10	
	12.88 - 05.94		6905.40.00	310GSBL KZIS - 3	
			3300.90.08 3313.20.00 3309.30.00	330 10	
			3620.90.10 3610.20.00 3610.30.00	MFZ330 330GSZ MFZ362 362GTZ	

Vehicle list



MAN

M 90 08.88 - 12.98

12.192 F, 12.192 FL M01, M02 12.192 FA M07	07.90 - 06.96	D 0826 LF01	3500.90.04	350 10	
	10.92 - 06.96	D 0826 LF05 D 0826 LF07	3573.20.00	MF350	
			3587.30.00	350GSZ	
			6905.40.00	KZIS - 3	
			3878.20.00	380	GMF380
			3879.20.00	380	GMF380
12.192 FAK M07 12.192 FK M01 12.192 FS, 12.192 FLS M01, M02	07.90 - 06.96	D 0826 LF01	3500.90.04	350 10	
	07.90 - 06.96	D 0826 LF05	3573.20.00	MF350	
	07.90 - 06.96	D 0826 LF07	3587.30.00	350GSZ	
			6905.40.00	KZIS - 3	
			3879.20.00	380	GMF380
			3871.30.00	380 10	380/70GSZ
8505.40.00	KZI - 4,5				
12.222 F, 12.222 FL M01, M02 12.222 FA M07 12.222 FLS M02 12.222 FK M01 12.222 FAK M07 12.262 F, 12.262 FL M01, M02 12.262 FS, 12.262 FLS M01, M02 12.262 FK M01 14.162 F, 14.162 FL M03, M04 14.162 FK M03 14.162 FS, 14.162 FLS M03, M04 14.222 F, 14.222 FL M03, M04 14.222 FK M03 14.222 FLS M04 14.262 F, 14.262 FL M03, M04 14.262 FK M03 14.262 FS, 14.262 FLS M03, M04	05.94 - 06.96	D 0824 LF 02	3168.20.00	310	MF310
	05.94 - 06.96	D 0826 LF11	3127.30.00	310 10	310GSBL
	05.94 - 06.96	D 0826 LF13	6905.40.00	KZIS - 3	
	05.94 - 06.96		3300.90.08	330 10	MFZ330
	08.95 - 06.96		3313.20.00	330GSZ	
	08.95 - 06.96		3309.30.00		
	08.95 - 06.96	D 0826 LF13	3500.90.04	350 10	MF350
			3573.20.00	350GSZ	
			3587.30.00	KZIS - 3	
			6905.40.00		
			3879.20.00	380	GMF380
			3871.30.00	380 10	380/70GSZ
			8505.40.00	KZI - 4,5	
			3878.20.00	380	GMF380
3857.30.00			380 10	380W2GSZ	
12.232 F, 12.232 FL M01, M02 12.232 FA M07 12.232 FAK M07 12.232 FK M01 12.232 FS, 12.232 FLS M01, M02	08.88 - 06.96	D 0826 LF02	3879.20.00	380	GMF380
	05.90 - 06.96	D 0826 LF06	3871.30.00	380 10	380/70GSZ
	05.90 - 06.96	D 0826 LF08	8505.40.00	KZI - 4,5	
	08.88 - 06.96		3878.20.00	380	GMF380
	08.88 - 06.96		3857.30.00	380 10	380W2GSZ
	08.88 - 06.96				

Vehicle list



MAN

M 90 08.88 - 12.98

12.272 F, 12.272 FL M01, M02, 6871cc 12.272 FS, 12.272 FLS M01, M02, 6871cc	10.92 - 06.96	D 0826 LF04	3879.20.00	380 GMF380	
			3871.30.00	380 10 380/70GSZ	
			8505.40.00	KZI - 4,5	
			3878.20.00	380 GMF380	
			3857.30.00	380 10 380W2GSZ	
12.272 F, 12.272 FLM 01, M02, 9973cc 12.272 FA M07 12.272 FAK M07 12.272 FK M01, 9973cc 12.272 FS, 12.272 FLS M01, M02, 9973cc 14.272 F, 14.272 FL M03, M04, 9973cc 14.272 FK M03, 9973cc 14.272 FS, 14.272 FLS M03, M04, 9973cc	09.91 - 10.92	D 0826 LF04	3879.20.00	380 GMF380	
	10.93 - 04.95	D 2865 LF02	3857.30.00	380 10 380W2GSZ	
	10.93 - 04.96	D 2865LF02	8505.40.00	KZI - 4,5	
	09.91 - 10.92		3878.20.00	380 GMF380	
	09.91 - 10.92		3871.30.00	380 10 380/70GSZ	
	09.91 - 10.92				
	09.91 - 10.92				
12.272 FK M01 15.272 M03,04	10.92 - 06.96	D 0826 LF04	3879.20.00	380 GMF380	
	01.91 -		3871.30.00	380 10 380/70GSZ	
			8505.40.00	KZI - 4,5	
			3878.20.00	380 GMF380	
			3857.30.00	380 10 380W2GSZ	
13.152 M01,02	01.88 -		3168.20.00	310 MF310	
			3127.30.00	310 10 310GSBL	
			6905.40.00	KZIS - 3	
			3300.90.08	330 10 MFZ330 330GSZ	
			3620.90.10	362 10 MFZ362 362GTZ	
			3313.20.00		
			3309.30.00		
13.192 M01,02 15.192 M03,04	01.88 - 01.88 -		3500.90.04	350 10 MF350 350GSZ KZIS - 3	
			3573.20.00		
			3587.30.00		
			6905.40.00		
			3879.20.00	380 GMF380	
			3871.30.00	380 10 380/70GSZ	
			8505.40.00	KZI - 4,5	
			3878.20.00	380 GMF380	
			3857.30.00	380 10 380W2GSZ	

Vehicle list



MAN

M 90 08.88 - 12.98

13.232 M01,02 13.272 M01,02 15.232 M03,04	01.88 -			3879.20.00	380 GMF380
	01.91 -			3871.30.00	380 10 380/70GSZ
	01.88 -			8505.40.00	KZI - 4,5
				3878.20.00	380 GMF380
				3857.30.00	380 10 380W2GSZ
14.152 F,14.152 FL M03, M04, 110kW 14.152 FK M03, 110kW 14.152 FS,14.152 FLS M03, M04, 110kW	12.88 - 04.94	D 0826 F01		3168.20.00	310 MF310
	12.88 - 05.94	D 0826 F02		3127.30.00	310 10 310GSBL
	12.88 - 05.94			6905.40.00	KZIS - 3
				3300.90.08	330 10 MFZ330
				3313.20.00	330GSZ
				3309.30.00	
				3620.90.10	362 10 MFZ362
			3610.20.00	362GTZ	
			3610.30.00		
14.152 F,14.152 FL M03, M04, 114kW 14.152 FK M03, 114kW 14.152 FS,14.152 FLS M03, M04, 114kW	05.94 - 06.96	D 0824 LF 01		3168.20.00	310 MF310
	05.94 - 06.96			3127.30.00	310 10 310GSBL
	05.94 - 06.96			6905.40.00	KZIS - 3
				3300.90.08	330 10 MFZ330
				3313.20.00	330GSZ
			3309.30.00		
14.192 F,14.192 FLM 03, M04, 137kW 14.192 FS,14.192 FLS M03, M04, 137kW	08.88 - 06.90	D 0826 TF		3500.90.04	350 10 MF350
	08.88 - 06.90			3573.20.00	350GSZ
				3587.30.00	KZIS - 3
				6905.40.00	
				3879.20.00	380 GMF380
				3878.20.00	380 GMF380
				3857.30.00	380 10 380W2GSZ
14.192 F,14.192 FL M03, M04, 140kW 14.192 FK M03, 140kW 14.192 FS,14.192 FLS M03, M04, 140kW 17.222 FA M08 17.222 FAK M08 18.222 F,18.222 FL,18.222 FLL M16, M06, M05 18.222 FK M05 18.262 F,18.262 FL,18.262 FLL M16, M06, M05 18.262 FK M05 24.222 FNL,24.222 FNLL,24.222 FVL M09, M10, M19 24.262 FNL,24.262 FNLL,24.262 FVL M09, M10, M19	07.90 - 06.96	D 0826 LF01		3500.90.04	350 10 MF350
	07.90 - 06.96	D 0826 LF05		3573.20.00	350GSZ
	07.90 - 06.96	D 0826 LF07		3587.30.00	KZIS - 3
	07.90 - 06.96	D 0826 LF11		6905.40.00	
	05.94 - 06.96	D 0826 LF13		3879.20.00	380 GMF380
	05.94 - 06.96			3871.30.00	380 10 380/70GSZ
	05.94 - 06.96			3878.20.00	380 GMF380
	08.95 - 06.96			3857.30.00	380 10 380W2GSZ
	08.95 - 06.96			8505.40.00	KZI - 4,5
	05.94 - 06.96				
	05.94 - 06.96				
	08.95 - 06.96				
	08.95 - 06.96				

Vehicle list



MAN

M 90 08.88 - 12.98

14.232 F,14.232 FL M03, M04, 160kW	05.90 - 04.95	D 0826		3879.20.00	380	
14.232 F,14.232 FL M03, M04, 169kW	08.88 - 06.96	LF/217/Silent			GMF380	
14.232 FK M03	08.88 - 06.96	D 0826 LF02		3871.30.00	380 10	
14.232 FS,14.232 FLS M03, M04, 160kW	05.90 - 04.95	D 0826 LF06			380/70GSZ	
14.232 FS,14.232 FLS M03, M04, 169kW	08.88 - 06.96	D 0826 LF08		3878.20.00	380	
				3857.30.00	GMF380	
				8505.40.00	380 10	
					380W2GSZ	
					KZI - 4,5	
14.192 FK M03, 137kW	08.88 - 06.90	D 0826 TF		3500.90.04	350 10	
				3573.20.00	MF350	
				3587.30.00	350GSZ	
				6905.40.00	KZIS - 3	
14.272 F,14.272 FL M03, M04, 6871cc	10.92 - 06.96	D 0826 LF04		3879.20.00	380	
14.272 FK M03, 6871cc	10.92 - 06.96				GMF380	
14.272 FS,14.272 FLS M03, M04, 6871cc	12.92 - 06.96			3871.30.00	380 10	
					380/70GSZ	
				3878.20.00	380	
				3857.30.00	GMF380	
				8505.40.00	380 10	
					380W2GSZ	
					KZI - 4,5	
17.192 F,17.192 FL M06, M05, 137kW	08.88 - 06.90	D 0826 TF		3500.90.04	350 10	
17.192 FA M08, 137kW	02.89 - 06.90	D 2865 LF02		3573.20.00	MF350	
17.192 FAK M08, 137kW	02.89 - 06.90			3587.30.00	350GSZ	
17.192 FK M05, 137kW	08.88 - 06.90			6905.40.00	KZIS - 3	
17.192 FS,17.192 FLS M06, M05, 137kW	08.88 - 06.90			3879.20.00	380	
17.272 FLS M06, 9973cc	09.91 - 05.95				GMF380	
18.272 F,18.272 FL,18.272 FLL M16, M06, M05, 9973cc	09.91 - 05.94			3871.30.00	380 10	
18.272 FK M05, 9973cc	09.91 - 05.94				380/70GSZ	
				3878.20.00	380	
				3857.30.00	GMF380	
				8505.40.00	380 10	
					380W2GSZ	
					KZI - 4,5	
17.192 F,17.192 FL M06, M05, 140kW	07.90 - 04.95	D 0826 LF01		3500.90.04	350 10	
17.192 FA M08, 140kW	07.90 - 06.96	D 0826 LF05		3573.20.00	MF350	
17.192 FAK M08, 140kW	07.90 - 06.96			3587.30.00	350GSZ	
17.192 FK M05, 140kW	07.90 - 01.91			6905.40.00	KZIS - 3	
17.192 FS,17.192 FLS M06, M05, 140kW	07.90 - 04.95			3879.20.00	380	
					GMF380	
				3871.30.00	380 10	
					380/70GSZ	
				3878.20.00	380	
				3857.30.00	GMF380	
				8505.40.00	380 10	
					380W2GSZ	
					KZI - 4,5	
				3800.90.14	380 10	
				3878.20.00	GMF380	
				3871.30.00	380/70GSZ	
				8505.40.00	KZI - 4,5	

Vehicle list



MAN

M 90 08.88 - 12.98

17.232 F, 17.232 FL M06, M05, 169kW	08.88 - 04.95	D 0826		3879.20.00	380	
17.232 F, 17.232 FL M06, M05, 160kW	05.90 - 04.95	LF/217/Silent D 0826 LF02		3871.30.00	380 10	GMF380 380/70GSZ
17.232 FA M08, 169kW	02.89 - 06.96	D 0826 LF06		3878.20.00	380	
17.232 FA M08, 160kW	05.90 - 04.95	D 0826 LF08		3857.30.00	380 10	GMF380 380W2GSZ
17.232 FAK M08, 169kW	02.89 - 06.96			3878.20.00	380	
17.232 FAK M08, 160kW	05.90 - 04.95			3857.30.00	380 10	GMF380 380W2GSZ
17.232 FK M05, 169kW	08.88 - 01.91			8505.40.00	KZI - 4,5	
17.232 FK M05, 160kW	05.90 - 01.91			8505.40.00	KZI - 4,5	
17.232 FS, 17.232 FLS M06, M05, 169kW	08.88 - 04.95			3800.90.14	380 10	
17.232 FS, 17.232 FLS M06, M05, 160kW	05.90 - 04.95			3878.20.00	380 10	GMF380
				3871.30.00	380 10	380/70GSZ
				8505.40.00	KZI - 4,5	
17.272 FLS M06, 6871cc	10.92 - 05.95	D 0826 LF04		3879.20.00	380	
18.272 F, 18.272 FL, 18.272 FLL M16, M06, M05, 6871cc	10.92 - 06.96			3871.30.00	380 10	GMF380 380/70GSZ
18.272 FK M05, 6871cc	10.92 - 06.96			3878.20.00	380	
				3857.30.00	380 10	GMF380 380W2GSZ
				8505.40.00	KZI - 4,5	
				3800.90.14	380 10	
				3878.20.00	380 10	GMF380
				3871.30.00	380 10	380/70GSZ
				8505.40.00	KZI - 4,5	
18.192 F, 18.192 FL, 18.192 FLL M05, M06, M16,	09.90 - 06.96	D 0826 LF01		3500.90.04	350 10	
18.192 FK M05	09.90 - 06.96	D 0826 LF05		3573.20.00	MF350	
		D 0826 LF07		3587.30.00	350GSZ	
				6905.40.00	KZIS - 3	
				3879.20.00	380	
				3871.30.00	380 10	GMF380 380/70GSZ
				3878.20.00	380	
				3857.30.00	380 10	GMF380 380W2GSZ
				8505.40.00	KZI - 4,5	
				3800.90.14	380 10	
				3878.20.00	380 10	GMF380
				3871.30.00	380 10	380/70GSZ
				8505.40.00	KZI - 4,5	

Vehicle list



MAN

M 90 08.88 - 12.98

18.232 F, 18.232 FL, 18.232 FLL M16, M06, M05 18.232 FK M05	09.90 - 06.96	D 0826 LF02	3950.90.02	395 10	
	09.90 - 06.96	D 0826 LF06 D 0826 LF08	3956.20.00	MFZ395	
			3951.30.00	395WGTZ	
			8535.40.00	KZIZ - 4,5	
			3879.20.00	380	
				GMF380	
			3871.30.00	380 10	
			380/70GSZ		
			3878.20.00	380	
				GMF380	
			3857.30.00	380 10	
				380W2GSZ	
			8505.40.00	KZI - 4,5	
			3800.90.14	380 10	
			3878.20.00	GMF380	
			3871.30.00	380/70GSZ	
			8505.40.00	KZI - 4,5	
18.310		D2866 LOH 25	4301.20.00	430	
				MFZ430	
			4314.30.00	430 10	- Transmission type: ZF 6S85
				430WGTZ	
			8916.40.00	KZIZ - 5	
18.350 18.400		D 2866 LOH 23 D 2866 LOH 26	4300.90.05	430 10	
				MFZ430	
			4301.20.00	430WGTZ	
			4346.30.00	KZIZ - 5	
			8916.40.00		
24.192 FNL, 24.192 FNLL, 24.192 FVL M10, M19, M09	07.89 - 06.96	D 0826 LF01 D 0826 LF05 D 0826 LF07	3500.90.04	350 10	
				MF350	
			3573.20.00	350GSZ	
			3587.30.00	KZIS - 3	
			6905.40.00		
			3879.20.00	380	
				GMF380	
	3878.20.00	380			
		GMF380			
		3857.30.00	380 10		
			380W2GSZ		
			8505.40.00	KZI - 4,5	
24.232 FNL M09 24.232 FNL, 24.232 FNLL, 24.232 FVL M19, M10, M09	05.90 - 04.95	D 0826 LF/217/Silent	3879.20.00	380	
	07.89 - 06.96	D 0826 LF02 D 0826 LF06 D 0826 LF08	3871.30.00	380 10	
				380/70GSZ	
			3878.20.00	380	
				GMF380	
			3857.30.00	380 10	
				380W2GSZ	
			8505.40.00	KZI - 4,5	
24.272 FNL, 24.272 FNLL, 24.272 FVL M10, M19, M09	10.92 - 06.96	D 0826 LF04	3879.20.00	380	
				GMF380	
			3871.30.00	380 10	
				380/70GSZ	
			3878.20.00	380	
			GMF380		
			3857.30.00	380 10	
				380W2GSZ	
			8505.40.00	KZI - 4,5	
24.272 FNL, 24.272 FVL M10, M09	09.91 - 05.94	D 2865 LF02	4300.90.49	430 10	- From model year: 07.1993
				MFZ430	
			4301.20.00	430WGTZ	
			4346.30.00	KZIZ - 5	
			8916.40.00		

Vehicle list



MAN

M 90 08.88 - 12.98

24.192 FNL,24.192 FNLL,24.192 FVL M10, M19, M09	07.89 - 06.96	D 0826 LF01 D 0826 LF05 D 0826 LF07	3500.90.04	350 10 MF350 350GSZ KZIS - 3	- Engine code: D0826LF01,05	
			3573.20.00			
			3587.30.00			
			6905.40.00			
			3879.20.00			380 GMF380
3878.20.00	380 GMF380	- Engine code: D0826LF01,05				
3806.30.00	380 10 380W2GSZ	- Engine code: D0826LF01,05				
7951.40.00	KZIS - 4	- Engine code: D0826LF01,05				
24.222 FNL,24.222 FNLL,24.222 FVL M09, M10, M19	05.94 - 06.96	D 0826 LF11	3500.90.04	350 10 MF350 350GSZ KZIS - 3		
			3573.20.00			
			3587.30.00			
			6905.40.00			
			3879.20.00			380 GMF380
3816.30.00	380 10 380GSZ					
3878.20.00	380 GMF380					
3806.30.00	380 10 380W2GSZ					
7951.40.00	KZIS - 4					
24.232 FNL,24.232 FNLL,24.232 FVL M19, M10, M09 24.272 FNL,24.272 FNLL,24.272 FVL M10, M19, M09	07.89 - 06.96	D 0826 LF02 D 0826 LF04 D 0826 LF06 D 0826 LF08	3879.20.00	380 GMF380	- Engine code: D0826LF, 02,06, 04	
	10.92 - 06.96		3816.30.00		380 10 380GSZ	- Engine code: D0826LF, 02,06, 04
			3878.20.00		380 GMF380	- Engine code: D0826LF, 02,06, 04
			3806.30.00		380 10 380W2GSZ	- Engine code: D0826LF, 02,06, 04
			7951.40.00		KZIS - 4	- Engine code: D0826LF, 02,06,04
24.272 FNL,24.272 FVL M10, M09	09.91 - 05.94	D 2865 LF02	4300.90.49	430 10 MFZ430 430WGTZ KZIZ - 5	- From model year: 07/1993 - Engine code: D2865LF02,04,05	
			4301.20.00			
			4346.30.00			
			8916.40.00			
			4009.30.00		400 10 400WGVZ	- To model year: 06/1993 - Engine code: D2865LF02,04,05
8916.40.00	KZIZ - 5	- To model year: 06/1993 - Engine code: D2865LF02,04,05				
4286.30.00	420 10 420WGTZ	- Engine code: D2865 - For PTO				

M 2000 L 03.95 -

11.153 L72 11.163 L72 12.153 L72,74,76	- 03.96 - 03.96 - 03.96		3300.90.08	330 10 MFZ330 330GSZ	
			3313.20.00		
			3620.90.10	362 10 MFZ362 362GTZ	
			3610.20.00		
11.174 L72			3610.20.00	362 MFZ362	
			3610.30.00	362 10 362GTZ	
11.223 L73 11.224 L73	01.96 - 01.96 -		3950.90.02	395 10 MFZ395 395WGTZ KZIZ - 4,5	
			3956.20.00		
			3951.30.00		
			8535.40.00		

Vehicle list

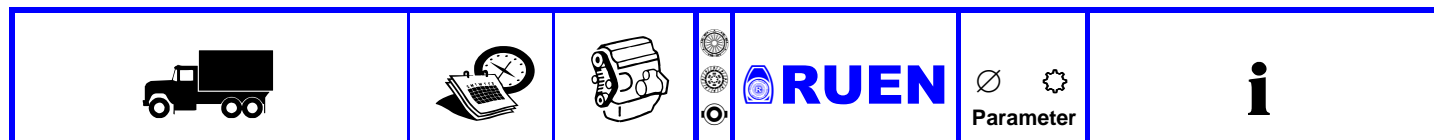

MAN

M 2000 L		03.95 -				
12.163 LC,12.163 LLC,LRC, LLRC L70, L72	08.95 -	D 0824 LFL 06 D 0824 LFL 09	3300.90.08	330 10	- To model year: 03.1996	
			3313.20.00	MFZ330		
			3309.30.00	330GSZ		
			3620.90.10	362 10		
			3610.20.00	MFZ362		
			3610.30.00	362GTZ		
			3950.90.02	395 10	- From model year: 04.1996	
			3956.20.00	MFZ395		
			3951.30.00	395WGTZ		
			8535.40.00	KZIZ - 4,5		
12.223 L73,75,77,79	01.96 -		3950.90.02	395 10		
12.263 L73,75,77,79	01.96 -		3956.20.00	MFZ395		
12.264 L73,75,77,79	01.96 -		3951.30.00	395WGTZ		
13.223 L75,77,79,80	01.96 -		8535.40.00	KZIZ - 4,5		
13.224 L75,77,79,80	01.96 -					
13.263 L75,77,79,80	01.96 -					
13.264 L75,77,79,80	01.96 -					
13.283 L75,77,79,80	01.96 -					
14.223 L75,77,79,80,86	01.96 -					
14.263 L75,77,79,80,86	01.96 -					
15.223 L82,84,86	01.96 -					
15.263 L82,84,86	01.96 -					
15.283 L82,84,86	01.96 -					
18.223 L87,88,89,90	01.96 -					
18.263 L87,88,89,90	01.96 -					
18.283 L87,88,89,90	01.96 -					
12.224 LC,12.224 LLC,LRC, LLRC L73, L71	08.95 -	D 0826 LFL03 D 0826 LFL10	3950.90.02	395 10		
			3956.20.00	MFZ395		
			3951.30.00	395WGTZ		
			8535.40.00	KZIZ - 4,5		
13.153 L74,76	- 03.96		3300.90.08	330 10		
13.163 L74,76	- 03.96		3313.20.00	MFZ330		
14.153 L74,76,81,83	- 03.96		3309.30.00	330GSZ		
15.153 L81,83	- 03.96		3620.90.10	362 10		
			3610.20.00	MFZ362		
			3610.30.00	362GTZ		
14..-18..			3950.90.01	395 18		
			3952.20.00	MF395		
			3960.30.00	395GTZ		
			3950.90.02	395 10		
			3956.20.00	MFZ395		
			3951.30.00	395WGTZ		
			8535.40.00	KZIZ - 4,5		
			3601.20.00	362		
				MF362		
			3607.30.00	362 10		
				362WGTZ		







Vehicle list



MAN

M 2000 L		03.95 -				
14.163 LC,14.163 LLC,LRC, LLRC L76, L74 14.163 LK, LRK L74	08.95 -	D 0824 LFL 06	3300.90.08	330 10	- To model year: 03.1996	
	08.95 -	D 0824 LFL 09	3313.20.00 3309.30.00	MFZ330 330GSZ		
			3620.90.10 3610.20.00 3610.30.00	362 10 MFZ362 362GTZ		
14.224 LAC, LARC L80 14.224 LAK, LARK, LAK-L L80 14.224 LC, LLC, LLLC, LRC, LLRC, LLLRC,14.224 LLC,14.224 LLLC L79, L77, L75 14.224 LK, LRK L75 14.264 LC,14.264 LLC,14.264 LLLC L77, L79, L75 14.264 LAC L80 14.264 LAK L80 14.264 LK L75	08.95 -	D 0826 LFL03	3950.90.02	395 10	- From model year: 04.1996	
	08.95 -	D 0826 LFL09	3956.20.00 3951.30.00 8535.40.00	MFZ395 395WGTZ KZIZ - 4,5		
	08.95 -	D 0826 LFL10				
14.284 LC,14.284 LLC,14.284 LLLC, LRC, LLRC, LLLRC L77, L79, L75 14.284, 14.285, LAC, LARC L80 14.284, 14.285, LAK, LARK, LAK-L L80 14.284, 14.285, LA-LF L80 14.284, 14.285, LK, LRK L75 15.284 LC, LLC, LLLC, LRC, LLRC, LLLRC L82, L84, L86 15.284 LK, LRK, LK-L L82 18.284 LAC, LARC L90 18.284 LAK, LARK, LAK-L L90	10.98 -	D 0836 LF 01	3950.90.02	395 10		
	06.98 -		3956.20.00 3951.30.00 8535.40.00	MFZ395 395WGTZ KZIZ - 4,5		
	06.98 -					
15.163 LC, LLC, LLLC, LLLRC, LLRC, LRCL83, L81 15.163 LK, LRK, LK-L L81	08.95 -	D 0824 LFL 06	3300.90.08	330 10	- To model year: 03.1996	
	08.95 -	D 0824 LFL 09	3313.20.00 3309.30.00	MFZ330 330GSZ		
15.224 LC,15.224 LLC,15.224 LLLC L82, L86, L84 15.224 LK L82 15.264 LC,15.264 LLC,15.264 LLLCL82, L86, L84 15.264 LK L82	08.95 -	15.224 LC,15.224 LLC,15.224 LLLCL82, L86, L84	3950.90.02	395 10		
	08.95 -	D 0826 LFL03	3956.20.00 3951.30.00 8535.40.00	MFZ395 395WGTZ KZIZ - 4,5		
	08.95 -	D 0826 LFL09				
18.224 LC,18.224 LLC,18.224 LLLC L87, L88, L89 18.224 LK,18.224 LLK L87, L88	08.95 -	D 0826 LFL03	3950.90.01	395 18	- To model year: 09.2002	
	08.95 -	D 0826 LFL10	3952.20.00 3960.30.00	MF395 395GTZ		
			3952.20.00	395	- From model year: 10.2002	
			3951.30.00	395 10	- From model year: 10.2002	
			3950.90.02 3956.20.00 3951.30.00 8535.40.00	MFZ395 395WGTZ KZIZ - 4,5		























Vehicle list

					
---	---	---	--	---	---

MAN

M 2000 L

03.95 -

18.224 LAC L90 18.224 LAK L90 18.264 LAC L90 18.264 LAK L90	08.95 - 08.95 - 08.95 - 08.95 -	D 0826 LFL03 D 0826 LFL09 D 0826 LFL10	   	3950.90.02 3956.20.00 3951.30.00 8535.40.00	395 10 MFZ395 395WGTZ KZIZ - 4,5	
18.255 LC, LLC, LLLC, LRC, LLRC, LLLRC, (LE250B) F L87, L88, L89 18.264 LK, 18.264 LLK L87, L88 18.264 LC, 18.264 LLC, 18.264 LLLC L87, L88, L89 18.284 LC, LLC, LLLC, LRC, LLRC, LLLRC L89, L88, L87 18.284, 18.285, LK, LK-L, LLK, LLK-L, LLRK, LRK L88, L87 18.284, 18.285, L-KO, LR-KO L87 18.285 LC, LLC, LLLC, LRC, LLRC, LLLRC, (LE280B) L87, L88, L89	09.99 - 08.95 - 08.95 - 06.98 - 06.98 - 06.98 - 09.99 -	D 0826 LFL09 D 0836 LF 01 D 0836 LFL 03 D 0836 LFL 05	   	3950.90.02 3956.20.00 3951.30.00 8535.40.00	395 10 MFZ395 395WGTZ KZIZ - 4,5	
26.224 DL-HK 6x4/2 L95 26.224 DLR-HK 6x4/2 L95 26.225 DL-HK 6x4/2 L95 26.225 DLR-HK 6x4/2 L95 26.255 DL-HK 6x4/2 L95 26.255 DLR-HK 6x4/2 L95 26.284 DL-HK 6x4/2 L95 26.284 DLR-HK 6x4/2 L95 26.284 DLR-TM 6x4/2 L95 26.284 DL-TM 6x4/2 L95 26.285 DL-HK 6x4/2 L95 26.285 DLR-HK 6x4/2 L95 26.285 DL-TM 6x4/2 L95	02.99 - 02.99 - 09.00 - 09.00 - 09.00 - 09.00 - 02.99 - 02.99 - 02.99 - 02.99 - 09.00 - 09.00 - 09.00 -	D 0826 LFL03 D 0826 LFL10 D 0836 LFL 01 D 0836 LFL 02 D 0836 LFL 03 D 0836 LFL 05	    	3950.90.02 3956.20.00 3951.30.00 8535.40.00 3951.30.00	395 10 MFZ395 395WGTZ KZIZ - 4,5 395 10 395WGTZ	
14.263, 14.264 LAC, LARC 14.263, 14.264 LAK, LARK, LAK-L 14.263, 14.264 LC, LLC, LLLC, LRC, LLRC, LLLRC 14.263, 14.264 LK, LRK 15.263, 15.264 LC, LLC, LLLC, LRC, LLRC, LLLRC 15.263, 15.264 LK, LRK, LK-L 18.263, 18.264, LAC, LARC L90 18.263, 18.264, LAK, LARK, LAK-L	08.95 - 08.95 - 08.95 - 08.95 - 08.95 - 08.95 - 08.95 - 08.95 -	D 0826 LFL09	   	3950.90.02 3956.20.00 3951.30.00 8535.40.00	395 10 MFZ395 395WGTZ KZIZ - 4,5	- Engine code: D0826LFL
18.263, 18.264, LC, LLC, LLLC, LRC, LLRC, LLLRC 18.263, 18.264, LK, LK-L, LLK, LLK-L, LLRK, LRK 26.224, 26.225, DL-HK, DLR-HK 26.255 DL-HK, DLR-HK L95 26.284 DL-TM, DLR-TM 26.284, 26.285, DL-HK, DLR-HK	08.95 - 08.95 - 11.02 - 11.02 - 05.01 - 11.02 -	D 0826 LFL09	    	3950.90.02 3956.20.00 3951.30.00 8535.40.00 3871.30.00	395 10 MFZ395 395WGTZ KZIZ - 4,5 380 10 380/70GSZ	

Vehicle list



MAN

M 2000 M 08.95 -

12.224 M32,33,34	08.95 -			3950.90.02	395 10	
12.264 M32,33,34	08.95 -			3956.20.00	MFZ395	
13.224 M32,33,34	08.95 -			3951.30.00	395WGTZ	
13.264 M32,33,34	08.95 -			8535.40.00	KZIZ - 4,5	
13.283 M32,33,34	08.95 -					
18.283 M38-41	03.95 -					
23.224 M42,44	06.95 -					
23.264 M42,44	06.95 -					
23.283 M42,44	06.95 -					
25.283 M42,44	06.95 -					
25.283 M43	06.95 -					
14.-18..				3950.90.02	395 10	
				3956.20.00	MFZ395	
				3951.30.00	395WGTZ	
				8535.40.00	KZIZ - 4,5	
				3601.20.00	362	
					MF362	
				3607.30.00	362 10	
					362WGTZ	
				3950.90.01	395 18	
				3952.20.00	MF395	
				3960.30.00	395GTZ	
14.224 MAK, MAK-L, MARK M34	08.95 - 12.05	D 0826 LF15		3950.90.02	395 10	
14.224 MC, MLC, MLLC, MLRC, MRC, MLLRC M32, M33, M31	08.95 - 12.05	D 0826 LF17		3956.20.00	MFZ395	
14.224 MLS, MLRS M32	08.95 - 12.05	D 0826 LF18		3951.30.00	395WGTZ	
14.264 MC, MLC, MLLC, MLRC, MRC, MLLRC M31, M33, M32	08.95 - 12.05			8535.40.00	KZIZ - 4,5	
14.264 MLS, MLRS M32	08.95 - 12.05					
14.284 MAK, MAK-L, MARK M34	06.98 - 12.05	D 0836 LF 01		3950.90.02	395 10	
14.284 MA-KO,14.284 MA-LF M34J	06.98 - 12.05			3956.20.00	MFZ395	
14.284 MC, MLC, MLLC, MLRC, MRC, MLLRC M31, M33, M32	06.98 - 12.05			3951.30.00	395WGTZ	
14.284 MLS, MLRS M32	06.98 - 12.05			8535.40.00	KZIZ - 4,5	
18.284 MAC, MARC M41	06.98 - 12.05					
18.284 MAK, MAK-L, MARK M41	06.98 - 12.05					
18.284 MC, MLC, MLLC, MLRC, MRC, MLLRC M39, M38, M40	06.98 - 12.05					
18.284 MK, MK-L, MLK, MLRK, MRK M39, M38	06.98 - 12.05					
18.284 MLS, MLRS M39	06.98 - 12.05					
18.224 MAC, MARC M41	08.95 - 12.05	D 0826 LF15		3950.90.02	395 10	
18.224 MAK, MAK-L, MARK M41	08.95 - 12.05	D 0826 LF18		3956.20.00	MFZ395	
18.224 MC, MLC, MLLC, MRC, MLRC, MLLRC M38, M39, M40	08.95 - 12.05			3951.30.00	395WGTZ	
18.224 MK, MK-L, MLK, MLRK, MRK M39, M38	08.95 - 12.05			8535.40.00	KZIZ - 4,5	
18.224 MLS, MLRS M39	08.95 - 12.05					
25.224 MNLC,25.224 MNLLC,25.224 MVLC M44, M42, M43	08.95 - 12.05	D 0826 LF15		3950.90.02	395 10	
25.264 MNLC,25.264 MNLLC,25.264 MVLC M44, M42, M43	08.95 - 12.05	D 0826 LF17		3956.20.00	MFZ395	
		D 0826 LF18		3951.30.00	395WGTZ	
				8535.40.00	KZIZ - 4,5	
18.284 M-KO, MR-KO M38	02.00 -	D 0826 LF15		3950.90.02	395 10	- Engine code: D0826LF
25.224 MNLC, MNLLC, MNLRC, MNLLRC, MVLC	08.95 - 12.05	D 0826 LF17		3956.20.00	MFZ395	
25.264 MNLC, MNLLC, MNLRC, MNLLRC, MVLC	08.95 - 12.05	D 0826 LF18		3951.30.00	395WGTZ	
		D 0826 LFL10		8535.40.00	KZIZ - 4,5	

Vehicle list

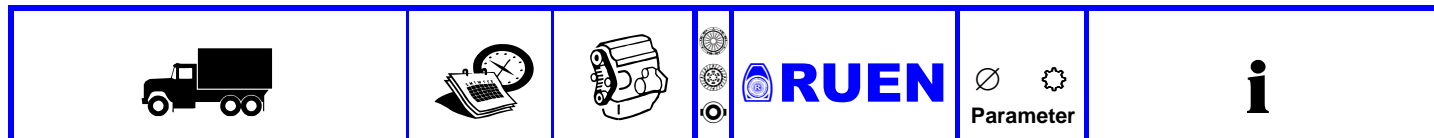

MAN

Sonderfahrzeuge

FE 26T 6x4 BL D28 Schweiz	04.95 - 03.05			4028.10.00	400 MFZ2/400X	- GBox: ZF Ecosplit-3 - Vehicles with double disc clutch - This part number includes one clutch disc
FE 41T 8x4 BB D29	06.97 - 03.05					
FE 41T 8x4 BB D28	06.97 - 03.05			4036.30.00	400 10 400 WGTZ	- GBox: ZF Ecosplit-3 - Vehicles with double disc clutch
FE 50T 10x8-8 BH D28	03.96 - 03.04			8941.40.00	KZISZ-5	- GBox: ZF Ecosplit-3 - Vehicles with double disc clutch

TGA

03.00 -

14...18..				3950.90.02	395 10 MFZ395 395WGTZ KZIZ - 4,5	
18.280 LL H04	02.01 - 08.01	D 0836 LF 41		3950.90.02	395 10 MFZ395 395WGTZ KZIZ - 4,5	
18.330 LL H04	02.01 - 08.01	D 0836 LF 43 D 0836 LF 44		3956.20.00 3951.30.00 8535.40.00		
18.310 FAC, FARC H51	09.02 -	D 2866 LF26		4300.90.20	430 10 MFZ430 430WGTZ KZIZ - 5	
18.310 FAK, FAK-L, FALK, FALK-L, FHLK H51, H70	09.02 -	D 2866 LF27 D 2866 LF28		4319.20.00 4346.30.00 8916.40.00		
18.310 FALS, FARS, FAS H51	09.02 -	D 2866 LF37				
18.360 FAC, FARC H51	09.02 -			4300.90.13	430 10 MFZ430 430WGTZ KZISZ - 5	- GBox: As-Tronic - Use release fork with cam
18.360 FAK, FAK-L, FALK, FALK-L, FHLK H70, H51	09.02 -			4319.20.00 4346.30.00 8919.40.00		
18.360 FALS, FARS, FAS, FHLS H51, H70	09.02 -					
18.410 FAC, FARC H51	09.02 -			4300.90.56	430 10 MFZ430 430WGTZ KZISZ - 5	- GBox: AS-Tronic - Use release fork with rollers
18.410 FAS, FALS, FARS H51, H70	09.02 -			4319.20.00 4346.30.00 8939.40.00		
18.410, 18.420 FAK, FAK-L, FALK, FALK-L H51, H70	09.02 -					
24.360 FNLLC/N, FNLLW, FNLLRW, FNLLRC H44	09.01 -					
24.410 FNLLC, FNLLW, FNLLRW, FNLLRC H44	09.01 -					
26.310 FDAC, FDARC, FDHC H55	02.02 -					
26.310 FDAK, FDHK H55	02.02 -					
26.310 FDARS, FDAS, FDHS H55	02.02 -					
26.360 FDAC, FDARC, FDHC, FDHLC H55	02.02 -					
26.360 FDAK, FDALK, FDHK, FDHLK H55, H72	02.02 -					
26.360 FDARS, FDAS, FDHLS, FDHS H55	02.02 -					
26.410 FDAC, FDARC H55	02.02 -					
26.410 FDAK, FDALK H55, H72	02.02 -					
26.410 FDALS, FDARS, FDAS H55, H72	02.02 -					
32.310 FFDC, FFDLC, FFDLRC, FFDRC H40, H36	01.02 -					
32.310 FFDK, FFDLK H40, H36	01.02 -					
32.310 FFD-TM, FFDR-TM H36	01.02 -					
32.360 FFDC, FFDLC, FFDLRC H40, H36	01.02 -					
32.360 FFDK, FFDLK H40, H36	01.02 -					
32.410 FFDC, FFDLC, FFDRC, FFDLRC H40, H36	01.02 -					
32.410 FFDK, FFDLK H40, H36	01.02 -					
32.410 FFD-TM, FFDR-TM H36, H48	01.02 -					
33.360 FDAC, FDARC, FDHC H55, H54	09.02 -					
33.360 FDAK, FDARK, FDHK H55, H54	09.02 -					
33.360 FDARS, FDAS, FDHS H55, H54	09.02 -					

Vehicle list



MAN

TGA 03.00 -

18.310, 18.320 FAC, FARC, FHLC H52, H22	05.04 -	D 2066 LF 02		4300.90.52	430 10	- GBox: ZF Ecosplit-3
18.310, 18.320 FAK, FAK-L, FALK, FALK-L, FHLK H80, H52, H22	05.04 -	D 2066 LF 03		4319.20.00	MFZ430	
18.310, 18.320 FALS, FARS, FAS, FHLS H80, H52, H22	05.04 -	D 2066 LF 04		4346.30.00	430WGTZ	
18.310, 18.320 FC, FLC, FLLC, FLLRC, FLLRW, FLLW, FLRC, FRC H15, H06, H03, H10	05.04 -	D 2066 LF 12		8916.40.00	KZIZ - 5	
18.310, 18.320 FK, FK-L, FLK, FLRK H06, H03, H02	05.04 -	D 2066 LF 13		8919.40.00	KZISZ - 5	- GBox: AS-Tronic
18.310, 18.320 FAK, FAK-L, FALK, FALK-L, FHLK, FHLK/M H52, H80, HV5, H22	05.04 -	D 2066 LF 14		4300.90.56	430 10	- GBox: AS-Tronic
18.310, 18.320 FALS, FARS, FAS, FHLS H52, H80, HV5, H22	05.04 -	D 2066 LF 26		4319.20.00	MFZ430	- Use release fork with rollers
18.350, 18.360 FAC, FARC, FHLC H52, HV5, H22	05.04 -	D 2066 LF 28		4346.30.00	430WGTZ	
18.350, 18.360 FAK, FAK-L, FALK, FALK-L, FHLK, FHLK/M H52, H80, HV5, H22	05.04 -	D 2066 LF 32		8939.40.00	KZISZ - 5	
18.350, 18.360 FALS, FARS, FAS, FHLS H52, H80, HV5, H22	05.04 -	D 2066 LF 33		43461.30.00	430 10	- GBox: ZF 16S-151/181
18.390, 18.400 FAC, FARC, FHLC H52, HV5, H22	05.04 -	D 2066 LF 35			430WGTZ	- For PTO
18.390, 18.400 FAK, FAK-L, FALK, FALK-L, FHLK, FHLK/M H52, H80, HV5, H22	05.04 -	D 2066 LF 37		8950.40.00	KZIZ-6	- GBox: ZF 16S-151/181
18.390, 18.400 FALS, FARS, FAS, FHLS H52, H80, HV5, H22	05.04 -	D 2066 LF 38				- For PTO
18.390, 18.400 FC, FLC, FLLC, FLLRC, FLLRW, FLLW, FLRC H15, H06, H03, H10	05.04 -	D 2066 LF 39				
18.390, 18.400 FK, FK-L, FLK, FLRK H06, H03	05.04 -					
18.350, 18.360 FC, FLC, FLLC, FLLRC, FLLW, FLRC, FLLRW, FRC H15, H06, H03, H10	05.04 -	D 2066 LF 03		4300.90.52	430 10	- GBox: ZF Ecosplit-3
18.350, 18.360 FAK, FK-L, FLK, FLRK H06, H03	05.04 -	D 2066 LF 13		4319.20.00	MFZ430	
		D 2066 LF 27		4346.30.00	430WGTZ	
		D 2066 LF 33		8916.40.00	KZIZ - 5	
		D 2066 LF 38		8919.40.00	KZISZ - 5	- GBox: AS-Tronic
				4300.90.56	430 10	- GBox: ZF Ecosplit-3
				4319.20.00	MFZ430	
				4346.30.00	430WGTZ	
				8939.40.00	KZISZ - 5	
				43461.30.00	430 10	- GBox: 16S-151/181
					430WGTZ	- For PTO
				8950.40.00	KZIZ-6	- GBox: 16S-151/181
						- For PTO

Vehicle list



MAN

TGA 03.00 -

18.310 FLLRS, FLLS, FLRS, FLS, FLS-TS H12, H09, H05, H01	04.00 -	D 2066 LF 01		4300.90.20	430 10	- GBox: ZF Ecosplit-3
18.310, 18.320 FC, FLC, FLLC, FLLRC, FLLRW, FLLW, FLRC, FRC H09, H05, H14, H02	04.00 -	D 2066 LF 02		4319.20.00	MFZ430	
		D 2066 LF 03		4346.30.00	430WGTZ	
		D 2066 LF 04		8916.40.00	KZIZ - 5	
18.310, 18.320 FK, FLK, FK-L, FLRK H05, H02	12.00 -	D 2066 LF 11		4028.10.00	400	- GBox: ZF Ecosplit-3
		D 2066 LF 12			MFZ2/400X	- Vehicles with double disc clutch
18.350 FLLRS, FLLS, FLRS, FLS, FLS-TS H06, H13, H10, H65, H08	05.04 -	D 2066 LF 13				- This part number includes one clutch disc
18.360 FC, FLC, FLLC, FLLRC, FLLW, FLRC, FLLRW, FRC H09, H05, H02, H14	04.00 -	D 2066 LF 26		8941.40.00	KZISZ-5	- GBox: ZF-Ecosplit-3
		D 2066 LF 32				- Vehicles with double disc clutch
18.360 FK, FLK, FK-L, FLRK H02, H05	12.00 -	D 2066 LF 35		4300.90.13	430 10	- GBox: AS-Tronic
		D 2066 LF 37		4319.20.00	MFZ430	- Use release fork with cam
18.360 FLLRS, FLLS, FLRS, FLS, FLS-TS H12, H09, H61, H05, H01	04.00 -	D 2866 LF26		4346.30.00	430WGTZ	
		D 2866 LF27		8919.40.00	KZISZ - 5	
18.390 FLS, FLS-TS, FLLS, FLLRS H06, H13, H10, H65, H08	05.04 -	D 2866 LF28		4300.90.56	430 10	- GBox: AS-Tronic
		D 2866 LF32		4319.20.00	MFZ430	- Use release fork with rollers
18.410 FLLRS, FLLS, FLRS, FLS, FLS-TS H09, H05, H61, H01	04.00 -	D 2866 LF36		4346.30.00	430WGTZ	
		D 2866 LF37		8939.40.00	KZISZ - 5	
18.410, 18.420 FC, FRC, FLC, FLRC, FLLC, FLLW, FLLRC, FLLRW H09, H05, H02, H14	04.00 -			43461.30.00	430 10	- GBox: ZF 16S-151/181
					430WGTZ	- For PTO
18.410, 18.420 FK, FK-L, FLK, FLRK H02, H05	12.00 -			8950.40.00	KZIZ-6	- GBox: ZF 16S-151/181
						- For PTO
18.430 FLLRS, FLLS, FLRS, FLS, FLS-TS H06, H13, H10, H08, H65	05.04 -					
26.310 FDC, FDLC, FDLRC, FDRC, FNHLC, FVHLC H25, H29	01.01 -					
26.310 FDK, FDLK, FDLRK, FDRK H25, H29	09.02 -					
26.310 FDS, FDLS, FDRS, FDLRS, FNHLS H25, H29	01.01 -					
26.310, 26.320 FD-TM H26	06.05 -					
26.310 FPLS, FVLS, FNLS, FNLLS, FPLRS, FNLRS, FVLRS H17, H20, H23	12.00 -					
26.310 FVL-KO H23	12.00 -					
26.360 FDC, FDLC, FDLRC, FDRC, FNHLC, FVHLC H67, H63, H25, H29	01.01 -					
26.360 FDK, FDLK, FDRK, FDLRK H25, H29	09.02 -					
26.360 FDLS, FDLS/M, FDLRS, FDLRS/M, FDLRS-WW , FDRS H63, H25, H67, H29	09.03 -					
26.360 FDS, FDLS, FNLS, FNLRS, FPLS, FPLRS, FVLS, FVLRS H17, H20, H25, H23	12.00 -					
26.360 FD-TM, FDR-TM H25	01.01 -					
26.360 FVL-KO H23	12.00 -					
26.410 FDC, FDLC, FDLRC, FDRC H63, H25, H29	01.01 -					
26.410 FDK, FDRK, FDLK, FDLRK H25, H29	09.01 -					
18.310, 18.320 FLLRS, FLLS, FLRS, FLS, FLS-TS H06, H13, H10, H08	05.04 -	D 2066 LF 04		4300.90.20	430 10	- GBox: ZF Ecosplit-3
		D 2066 LF 14		4319.20.00	MFZ430	
		D 2066 LF 28		4346.30.00	430WGTZ	
		D 2066 LF 35		8916.40.00	KZIZ - 5	
		D 2066 LF 39		4300.90.13	430 10	- GBox: AS-Tronic
				4319.20.00	MFZ430	
				4346.30.00	430WGTZ	
				8919.40.00	KZISZ - 5	
				4300.90.56	430 10	- GBox: AS-Tronic
				4319.20.00	MFZ430	- Use release fork with rollers
				4346.30.00	430WGTZ	
				8939.40.00	KZISZ - 5	

Vehicle list

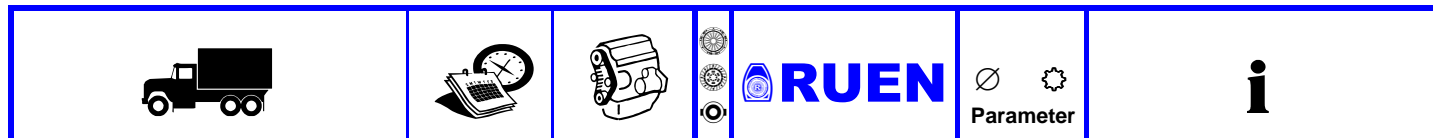

MAN

TGA		03.00 -			
18.430, 18.440 FAC, FARC, FHLC H52, HV5, H22	05.04 -	D 2066 LF 01	4300.90.101	430 10	- GBox: ZF Ecosplit-3
18.430, 18.440 FAK, FALK, FALK-L, FHLK, FHLK/M H52, H80, HV5, H22	05.04 -	D 2066 LF 11	4386.20.00	MFZ430	
18.430, 18.440 FALS, FAS, FHLS H52, H80, HV5, H22	05.04 -	D 2066 LF 25	4386.30.00	430WGTZ	
18.430, 18.440 FALS, FAS, FHLS H52, H80, HV5, H22	05.04 -	D 2066 LF 31	8916.40.00	KZIZ - 5	
18.430, 18.440 FC, FLC, FLLC, FLLRC, FLLRW, FLLW, FLRC H15, H06, H03, H10	05.04 -	D 2066 LF 36	4300.90.102	430 10	- GBox: ZF Ecosplit-3
18.430, 18.440 FC, FLC, FLLC, FLLRC, FLLRW, FLLW, FLRC H15, H06, H03, H10	05.04 -	D 2676 LF 01	4386.20.00	MFZ430	
18.430, 18.440 FC, FLC, FLLC, FLLRC, FLLRW, FLLW, FLRC H15, H06, H03, H10	05.04 -	D 2676 LF 05	4386.30.00	430WGTZ	
18.430, 18.440 FC, FLC, FLLC, FLLRC, FLLRW, FLLW, FLRC H15, H06, H03, H10	05.04 -	D 2676 LF 14	8916.40.00	KZIZ - 5	
18.430, 18.440 FK, FK-L, FLK, FLRK H06, H03	05.04 -		4300.90.103	430 10	- GBox: AS-Tronic
18.480 FC, FLC, FLLC, FLLRC, FLLRW, FLLW, FLRC H06, H15, H03, H10	01.06 -		4386.20.00	MFZ430	
18.480 FC, FLC, FLLC, FLLRC, FLLRW, FLLW, FLRC H06, H15, H03, H10	01.06 -		4386.30.00	430WGTZ	
18.480 FC, FLC, FLLC, FLLRC, FLLRW, FLLW, FLRC H06, H15, H03, H10	01.06 -		8919.40.00	KZISZ - 5	
18.480 FHLC H22	04.06 -		4300.90.104	430 10	- GBox: AS-Tronic - Use release fork with rollers
18.480 FHLK, FHLK/M H22	04.06 -		4386.20.00	MFZ430	
18.480 FHLK, FHLK/M H22	04.06 -		4386.30.00	430WGTZ	
18.480 FHLK, FHLK/M H22	04.06 -		8939.40.00	KZISZ - 5	
18.480 FHLS, FHLS/M H22	04.06 -		4300.90.105	430 10	- GBox: AS-Tronic - Use release fork with rollers
18.480 FHLS, FHLS/M H22	04.06 -		4386.20.00	MFZ430	
18.480 FHLS, FHLS/M H22	04.06 -		4386.30.00	430WGTZ	
18.480 FHLS, FHLS/M H22	04.06 -		8939.40.00	KZISZ - 5	
18.480 FK, FK-L, FLK, FLRK H06, H03	01.06 -		43461.30.00	430 10	- GBox: ZF 16S-151/181 - For PTO
18.480 FK, FK-L, FLK, FLRK H06, H03	01.06 -		8950.40.00	430WGTZ	- GBox: ZF 16S-151/181 - For PTO
18.460 FC, FLC, FLLC, FLLRC, FLLRW, FLLW, FLRC, FRC H09, H05, H02, H14	04.00 -	D 2876 LF 04	4300.90.101	430 10	- GBox: ZF Ecosplit-3, Eaton
18.460 FC, FLC, FLLC, FLLRC, FLLRW, FLLW, FLRC, FRC H09, H05, H02, H14	04.00 -	D 2876 LF 05	4386.20.00	MFZ430	
18.460 FC, FLC, FLLC, FLLRC, FLLRW, FLLW, FLRC, FRC H09, H05, H02, H14	04.00 -	D 2876 LF 07	4386.30.00	430WGTZ	
18.460 FC, FLC, FLLC, FLLRC, FLLRW, FLLW, FLRC, FRC H09, H05, H02, H14	04.00 -	D 2876 LF 12	8916.40.00	KZIZ - 5	
18.460 FK, FK-L, FLK, FLRK H02, H05	12.00 -	D 2876 LF 12	4300.90.102	430 10	- GBox: ZF Ecosplit-3, Eaton
18.460 FK, FK-L, FLK, FLRK H02, H05	12.00 -	D 2876 LF 12	4386.20.00	MFZ430	
18.460 FK, FK-L, FLK, FLRK H02, H05	12.00 -	D 2876 LF 12	4386.30.00	430WGTZ	
18.460 FK, FK-L, FLK, FLRK H02, H05	12.00 -	D 2876 LF 12	8916.40.00	KZIZ - 5	
18.460 FLLRS, FLLS, FLRS, FLS, FLS-TS H12, H09, H61, H05, H01	04.00 -	D 2876 LF 13	4300.90.102	430 10	- GBox: ZF Ecosplit-3, Eaton
18.460 FLLRS, FLLS, FLRS, FLS, FLS-TS H12, H09, H61, H05, H01	04.00 -	D 2876 LF 13	4386.20.00	MFZ430	
18.460 FLLRS, FLLS, FLRS, FLS, FLS-TS H12, H09, H61, H05, H01	04.00 -	D 2876 LF 13	4386.30.00	430WGTZ	
18.460 FLLRS, FLLS, FLRS, FLS, FLS-TS H12, H09, H61, H05, H01	04.00 -	D 2876 LF 13	8916.40.00	KZIZ - 5	
18.480 FC, FLC, FLLC, FLLRC, FLLRW, FLLW, FLRC H09, H02, H05, H14	09.02 -	D 2876 LF 25	4028.10.00	400	- GBox: ZF Ecosplit-3 - Vehicles with double disc clutch
18.480 FC, FLC, FLLC, FLLRC, FLLRW, FLLW, FLRC H09, H02, H05, H14	09.02 -	D 2876 LF 25	4036.30.00	MFZ2/400X	
18.480 FC, FLC, FLLC, FLLRC, FLLRW, FLLW, FLRC H09, H02, H05, H14	09.02 -	D 2876 LF 25	4036.30.00	400 10	- GBox: ZF Ecosplit-3 - Vehicles with double disc clutch
18.480 FC, FLC, FLLC, FLLRC, FLLRW, FLLW, FLRC H09, H02, H05, H14	09.02 -	D 2876 LF 25	4036.30.00	400 WGTZ	
18.480 FC, FLC, FLLC, FLLRC, FLLRW, FLLW, FLRC H09, H02, H05, H14	09.02 -	D 2876 LF 25	8941.40.00	KZISZ-5	- GBox: ZF Ecosplit-3 - Vehicles with double disc clutch
18.480 FC, FLC, FLLC, FLLRC, FLLRW, FLLW, FLRC H09, H02, H05, H14	09.02 -	D 2876 LF 25	43461.30.00	430 10	- GBox: ZF 16S-151/181 - For PTO
18.480 FC, FLC, FLLC, FLLRC, FLLRW, FLLW, FLRC H09, H02, H05, H14	09.02 -	D 2876 LF 25	8950.40.00	430WGTZ	- GBox: ZF 16S-151/181 - For PTO
18.480 FC, FLC, FLLC, FLLRC, FLLRW, FLLW, FLRC H09, H02, H05, H14	09.02 -	D 2876 LF 25	4300.90.103	430 10	- GBox: AS-Tronic
18.480 FC, FLC, FLLC, FLLRC, FLLRW, FLLW, FLRC H09, H02, H05, H14	09.02 -	D 2876 LF 25	4386.20.00	MFZ430	
18.480 FC, FLC, FLLC, FLLRC, FLLRW, FLLW, FLRC H09, H02, H05, H14	09.02 -	D 2876 LF 25	4386.30.00	430WGTZ	
18.480 FC, FLC, FLLC, FLLRC, FLLRW, FLLW, FLRC H09, H02, H05, H14	09.02 -	D 2876 LF 25	8919.40.00	KZISZ - 5	
26.460 FPLS, FPLRS, FVLS, FVLRS, FNLS, FNLLS, FNLRH H17, H20, H23	12.00 -		4300.90.104	430 10	- GBox: AS-Tronic
26.460 FPLS, FPLRS, FVLS, FVLRS, FNLS, FNLLS, FNLRH H17, H20, H23	12.00 -		4386.20.00	MFZ430	
26.460 FPLS, FPLRS, FVLS, FVLRS, FNLS, FNLLS, FNLRH H17, H20, H23	12.00 -		4386.30.00	430WGTZ	
26.460 FPLS, FPLRS, FVLS, FVLRS, FNLS, FNLLS, FNLRH H17, H20, H23	12.00 -		8939.40.00	KZISZ - 5	
26.460 FVLC H23	02.01 -		4300.90.105	430 10	- GBox: AS-Tronic - Use release fork with rollers
26.460 FVLC H23	02.01 -		4386.20.00	MFZ430	
26.460 FVLC H23	02.01 -		4386.30.00	430WGTZ	
26.460 FVLC H23	02.01 -		8939.40.00	KZISZ - 5	
26.480 FNLC, FNLLC, FNLLRC, FNLLW, FNLRH H17, H20, H23	09.02 -		4300.90.105	430 10	- GBox: AS-Tronic - Use release fork with rollers
26.480 FNLC, FNLLC, FNLLRC, FNLLW, FNLRH H17, H20, H23	09.02 -		4386.20.00	MFZ430	
26.480 FNLC, FNLLC, FNLLRC, FNLLW, FNLRH H17, H20, H23	09.02 -		4386.30.00	430WGTZ	
26.480 FNLC, FNLLC, FNLLRC, FNLLW, FNLRH H17, H20, H23	09.02 -		8939.40.00	KZISZ - 5	
26.480 FNLS, FNLLS, FNLRH H17, H20, H23	09.02 -		4300.90.105	430 10	- GBox: AS-Tronic - Use release fork with rollers
26.480 FNLS, FNLLS, FNLRH H17, H20, H23	09.02 -		4386.20.00	MFZ430	
26.480 FNLS, FNLLS, FNLRH H17, H20, H23	09.02 -		4386.30.00	430WGTZ	
26.480 FNLS, FNLLS, FNLRH H17, H20, H23	09.02 -		8939.40.00	KZISZ - 5	
26.530 FNLC, FNLLC, FNLLRC, FNLLRW, FNLLW, FNLRH H17, H20, H23	09.02 -		4300.90.105	430 10	- GBox: AS-Tronic - Use release fork with rollers
26.530 FNLC, FNLLC, FNLLRC, FNLLRW, FNLLW, FNLRH H17, H20, H23	09.02 -		4386.20.00	MFZ430	
26.530 FNLC, FNLLC, FNLLRC, FNLLRW, FNLLW, FNLRH H17, H20, H23	09.02 -		4386.30.00	430WGTZ	
26.530 FNLC, FNLLC, FNLLRC, FNLLRW, FNLLW, FNLRH H17, H20, H23	09.02 -		8939.40.00	KZISZ - 5	
26.530 FNLS, FNLLS, FNLRH H17, H20, H23	09.02 -		4300.90.105	430 10	- GBox: AS-Tronic - Use release fork with rollers
26.530 FNLS, FNLLS, FNLRH H17, H20, H23	09.02 -		4386.20.00	MFZ430	
26.530 FNLS, FNLLS, FNLRH H17, H20, H23	09.02 -		4386.30.00	430WGTZ	
26.530 FNLS, FNLLS, FNLRH H17, H20, H23	09.02 -		8939.40.00	KZISZ - 5	

Vehicle list



MAN

TGA 03.00 -

18.480 FAC, FARC H51	09.02 -	D 2876 LF 04		4300.90.101	430 10	
18.480 FAK, FAK-L, FALK, FALK-L, FHLK H70, H51	09.02 -	D 2876 LF 05		4386.20.00	MFZ430	
18.480 FAS, FALS, FARS H51, H70	09.02 -	D 2876 LF 12		4386.30.00	430WGTZ	
24.460 FNLLC, FNLLRC, FNLLRW, FNLLW H44	09.01 -	D 2876 LF 13		8916.40.00	KZIZ - 5	
24.480 FNLLC, FNLLRC, FNLLRW, FNLLW H44	09.02 -	D 2876 LF 25		4300.90.102	430 10	
24.510 FNLLC/N, FNLLW, FNLLRW H44	09.01 -			4386.20.00	MFZ430	
24.530 FNLLC, FNLLRC, FNLLRW, FNLLW H44	09.01 -			4386.30.00	430WGTZ	
26.480 FDAC, FDALC, FDARC, FDHC, FDHLC H55, H72	09.02 -			8916.40.00	KZIZ - 5	
26.480 FDAK, FDALK, FDHK, FDHLK H55, H72	09.02 -			4300.90.103	430 10	
26.480 FDALS, FDARS, FDAS, FDHLS, FDHS H55, H72	09.02 -			4386.20.00	MFZ430	
32.460 FFDC, FFDLC, FFDLRC, FFDRC H40, H36	01.02 -			4386.30.00	430WGTZ	
32.460 FFDK, FFDLK H40, H36	01.02 -			8919.40.00	KZISZ - 5	
32.460 FFD-TM, FFDR-TM H36, H48	01.02 -			4300.90.104	430 10	- GBox: AS-Tronic - Use release fork with rollers
32.480 FFDC, FFDLC, FFDLRC, FFDRC H40, H36	09.02 -			4386.20.00	MFZ430	
32.480 FFDK, FFDLK H40, H36	09.02 -			4386.30.00	430WGTZ	
32.480 FFD-TM, FFDR-TM H36, H48	09.02 -			8939.40.00	KZISZ - 5	
33.480 FDAC, FDAC-WW, FDALC, FDARC H55, H72, HH54	09.02 -			4300.90.105	430 10	- GBox: AS-Tronic - Use release fork with rollers
33.480 FDAK, FDALK, FDARK, FDHK H55, H54, H72	09.02 -			4386.20.00	MFZ430	
33.480 FDALS, FDARS, FDAS, FDHS H55, H54, H72	09.02 -			4386.30.00	430WGTZ	
33.530 FDAK, FDALK H55, H72	09.02 -			8939.40.00	KZISZ - 5	
33.530 FDAS, FDALS H55, H72	09.02 -					

Vehicle list



MAN

TGA 03.00 -

26.310, 26.320 FDC, FDLC, FDLRC, FDRC, FNHLC, FVHLC H35, H26, H42, H30	05.04 -	D 2066 LF 02 D 2066 LF 03	4300.90.52 4319.20.00 4346.30.00 8916.40.00	430 10 MFZ430 430WGTZ KZIZ - 5	- GBox: ZF-Ecosplit-3
26.310, 26.320 FDK, FDLK, FDLRK, FDRK H26, H30	05.04 -	D 2066 LF 04 D 2066 LF 06			
26.310, 26.320 FDS, FDLS, FDRS, FNHLS, FDLRS H26, H35, H30	05.04 -	D 2066 LF 07 D 2066 LF 12	4028.10.00	400 MFZ2/400X	- GBox: ZF-Ecosplit-3 - Vehicles with double disc clutch
26.310, 26.320 FD-TM, FDR-TM H26	06.05 -	D 2066 LF 13	4036.30.00	400 10 400 WGTZ	- GBox: ZF Ecosplit-3 - Vehicles with double disc clutch
26.310, 26.320 FNLC, FNLLC, FNLLRC, FNLLRW, FNLLW, FNLRC H18, H21	05.04 -	D 2066 LF 14	8941.40.00	KZISZ-5	- GBox: ZF-Ecosplit-3 - Vehicles with double disc clutch
26.310, 26.320 FNLS, FNLLS, FNLRS, FNLLRS, FPLRS, FPLS H18, H21	05.04 -	D 2066 LF 32	8919.40.00	KZISZ - 5	- GBox: AS-Tronic
26.310, 26.320 FVHL-KO H42	06.05 -	D 2066 LF 33			
26.350, 26.360 FDC, FDLC, FDLRC, FDRC, FNHLC, FVHLC H26, H35, H42, H67, H30	05.04 -	D 2066 LF 35 D 2066 LF 37	4300.90.56 4319.20.00 4346.30.00 8939.40.00	430 10 MFZ430 430WGTZ KZISZ - 5	- GBox: AS-Tronic
26.350, 26.360 FDK, FDLK, FDLRK, FDRK H26, H30	05.04 -		43461.30.00	430 10 430WGTZ	- GBox: ZF 16S-151/181 - For PTO
26.350, 26.360 FDLRS, FDLS, FDRS, FDS, FNHLS, FPHLS, FVHLS H26, H35, HV2, H42, H67, H30	05.04 -		8950.40.00	KZIZ-6	- GBox: ZF 16S-151/181 - For PTO
26.350, 26.360 FD-TM, FDR-TM H26	02.04 -				
26.350, 26.360 FNLC, FNLLC, FNLLRC, FNLLRW, FNLLW, FNLRC H18, H21, HV1	05.04 -				
26.350, 26.360 FNLS, FNLLS, FNLRS, FNLLRS, FPLS, FPLRS H18, H24, H21, HV1	05.04 -				
26.350, 26.360 FVHL-KO H42	06.05 -				
26.390, 26.400 FDC, FDLC, FDLRC, FDRC, FNHLC, FVHLC H26, H35, H42, H67, H30	05.04 -				
26.390, 26.400 FDK, FDLK H26, H30	05.04 -				
26.390, 26.400 FDLRS, FDLS, FDRS, FDS, FNHLS, FPHLS, FVHLS H26, H35, HV2, H42, H67, H30	05.04 -				
26.390, 26.400 FD-TM H26	05.04 -				
26.390, 26.400 FNLC, FNLLC, FNLLRC, FNLLRW, FNLLW, FNLRC H18, H21, HV1	05.04 -				
26.390, 26.400 FNLS, FNLLS, FNLRS, FNLLRS, FPLS, FPLRS H18, H24, H21, HV1	05.04 -				
26.390, 26.400 FVHL-KO H42	06.05 -				
33.350, 33.360 FDC, FDLC, FDRC H66, H26, HW2, H30	05.04 -				
33.350, 33.360 FDK, FDLK, FDRK H66, H26, HW2, H30	05.04 -				
33.350, 33.360 FDLRS, FDLS, FDRS, FDS H66, H26, HW2, HV2, H30	05.04 -				
33.390, 33.400 FDC, FDLC, FDRC, FDLRC H66, H26, HW2, H30	05.04 -				
33.390, 33.400 FDK, FDLK, FDRK H66, H26, HW2, H30	05.04 -				
33.390, 33.400 FDS, FDLS, FDLRS, FDRS H66, HW8, H26, HW2, HV2, HW9, H30	05.04 -				

Vehicle list



MAN

TGA 03.00 -

26.310 FNLC, FNLLC, FNLLRC, FNLLRW, FNLLW, FNLRC, FVLC H17, H20	09.00 -	D 2866 LF26 D 2866 LF27	4300.90.20 4319.20.00 4346.30.00 8916.40.00	430 10 MFZ430 430WGTZ KZIZ - 5	- GBox: ZF Ecosplit-3
26.360 FNLC, FNLLC, FNLLRC, FNLLRW, FNLLW, FNLRC, FVLC H17, H20, H23	09.00 -	D 2866 LF28 D 2866 LF36 D 2866 LF37	4028.10.00	400 MFZ2/400X	- GBox: ZF Ecosplit-3 - Vehicles with double disc clutch - This part number includes one clutch disc
28.310 FNLC, FNLLC, FNLRC H87, H86	09.02 -		4036.30.00	400 10 400 WGTZ	- GBox: ZF Ecosplit-3 - Vehicles with double disc clutch
28.310 FNLS, FNLRS H86	09.02 -		8941.40.00	KZISZ-5	- GBox: ZF Ecosplit-3 - Vehicles with double disc clutch
28.360 FNLC, FNLLC, FNLRC H87, H86	09.02 -		4300.90.13 4319.20.00 4346.30.00 8919.40.00	430 10 MFZ430 430WGTZ KZISZ - 5	- GBox: AS-Tronic - Use release fork with cam
28.360 FNLS, FNLRS H86	09.02 -		4300.90.56 4319.20.00 4346.30.00 8939.40.00	430 10 MFZ430 430WGTZ KZISZ - 5	- GBox: AS-Tronic - Use release fork with rollers
28.410 FNLC, FNLLC, FNLRC H87, H86	09.02 -		43461.30.00	430 10 430WGTZ	- GBox: ZF 16S-151/181 - For PTO
28.410 FNLS, FNLRS H86	09.02 -		8950.40.00	KZIZ-6	- GBox: ZF 16S-151/181 - For PTO
26.430, 26.440, FNLC, FNLLC, FNLLW, FNLRC, FNLLRC, FVLC H18, H21, HV1	05.04 -	D 2066 LF 01 D 2066 LF 11	4300.90.101 4386.20.00 4386.30.00 8916.40.00	430 10 MFZ430 430WGTZ KZIZ - 5	- GBox: ZF-Ecosplit-3
26.430, 26.440, FNLS, FNLLS, FNLRS, FNLLRS, FPLS, FPLRS H18, H24, H21, HV1	05.04 -	D 2066 LF 23 D 2066 LF 31	4300.90.102 4386.20.00 4386.30.00 8916.40.00	430 10 MFZ430 430WGTZ KZIZ - 5	- GBox: ZF-Ecosplit-3
26.480 FNLC, FNLLC, FNLLRC, FNLLW, FNLRC, FVLC H18, H24, H21, HV1	02.06 -	D 2676 LF 01 D 2676 LF 02 D 2676 LF 12	4028.10.00	400 MFZ2/400X	- GBox: ZF Ecosplit-3 - Vehicles with double disc clutch - This part number includes one clutch disc
26.480 FNLS, FNLLS, FNLRS, FPLS, FVLS, FVLRS H18, H24, H21, HV1	02.06 -		4036.30.00	400 10 400 WGTZ	- GBox: ZF Ecosplit-3 - Vehicles with double disc clutch
			8941.40.00	KZISZ-5	- GBox: ZF Ecosplit-3 - Vehicles with double disc clutch
			4300.90.103 4386.20.00 4386.30.00 8919.40.00	430 10 MFZ430 430WGTZ KZISZ - 5	- GBox: AS-Tronic
			4300.90.104 4386.20.00 4386.30.00 8939.40.00	430 10 MFZ430 430WGTZ KZISZ - 5	- GBox: AS-Tronic - Use release fork with rollers
			4300.90.105 4386.20.00 4386.30.00 8939.40.00	430 10 MFZ430 430WGTZ KZISZ - 5	- GBox: AS-Tronic - Use release fork with rollers
			43461.30.00	430 10 430WGTZ	- GBox: ZF 16S-151/181 - For PTO
			8950.40.00	KZIZ-6	- GBox: ZF 16S-151/181 - For PTO

Vehicle list



MAN

TGA 03.00 -

26.430, 26.440 FDC, FDLC, FDLRC, FDRC, FNHLC, FVHLC H26, H35, H42, H67, H30	05.04 -	D 2066 LF 01 D 2066 LF 11	4300.90.101 4386.20.00 4386.30.00 8916.40.00	430 10 MFZ430 430WGTZ KZIZ - 5	- GBox: ZF-Ecosplit-3
26.430, 26.440 FDK, FDLK H26, H30	05.04 -	D 2066 LF 31 D 2676 LF 01	4300.90.102 4386.20.00 4386.30.00 8916.40.00	430 10 MFZ430 430WGTZ KZIZ - 5	- GBox: ZF-Ecosplit-3
26.430, 26.440 FDLRS, FDLS, FDRS, FDS, FNHLS, FPHLS, FVHLS H26, H35, HV2, H42, H67, H30	02.04 -	D 2676 LF 02 D 2676 LF 03	4028.10.00	400 MFZ2/400X	- GBox: ZF Ecosplit-3 - Vehicles with double disc clutch - This part number includes one clutch disc
26.430, 26.440 FD-TM, FDR-TM H26	05.04 -		4036.30.00	400 10 400 WGTZ	- GBox: ZF Ecosplit-3 - Vehicles with double disc clutch
26.430, 26.440 FVLH-KO H42	06.05 -		8941.40.00	KZISZ-5	- GBox: ZF Ecosplit-3 - Vehicles with double disc clutch
26.480 FDC, FDLC, FDLRC, FDRC, FNHLC, FVHLC H26, H35, H42, H67, H30	02.06 -		4300.90.103 4386.20.00 4386.30.00 8919.40.00	430 10 MFZ430 430WGTZ KZISZ - 5	- GBox: AS-Tronic
26.480 FDK, FDLK, FDLRK H26, H30, 12412cc	02.06 -		4300.90.104 4386.20.00 4386.30.00 8939.40.00	430 10 MFZ430 430WGTZ KZISZ - 5	- GBox: AS-Tronic - Use release fork with rollers
26.480 FDLRS, FDLS, FDRS, FDS, FNHLS, FPHLS, FVHLS H35, H26, HV2, H42, H67, H30	02.06 -		4300.90.105 4386.20.00 4386.30.00 8939.40.00	430 10 MFZ430 430WGTZ KZISZ - 5	- GBox: AS-Tronic - Use release fork with rollers
26.480 FD-TM H26, 12412cc	02.06 -		43461.30.00	430 10 430WGTZ	- GBox: ZF 16S-151/181 - For PTO
26.480 FVHL-KO H42	02.06 -		8950.40.00	KZIZ-6	- GBox: ZF 16S-151/181 - For PTO
33.430, 33.440 FDC, FDLC, FDRC, FDLRC H66, H26, HW2,H30	05.04 -				
33.430, 33.440 FDK, FDLK, FDRK H66, H26, HW2,H30	05.04 -				
33.430, 33.440 FDLRS, FDLS, FDRS, FDS H66, H26, HW8, HW2, HV2,H30	05.04 -				
33.480 FDC, FDLC, FDRC H66, H26, HW2,H30	02.06 -				
33.480 FDK, FDLK, FDRK H66, H26, HW2,H30	02.06 -				
33.480 FDLRS, FDLS, FDRS, FDS H66, H26, HW8, HW2, HV2, H30, HW9	02.06 -				

Vehicle list

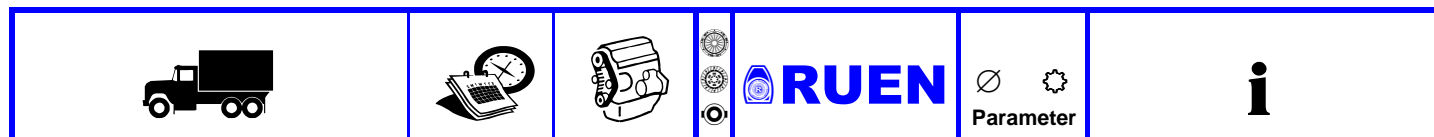

MAN

TGA 03.00 -

26.460 FDC, FDLC, FDLRC, FDRC H63, H25, H29	01.01 -	D 2876 LF 04	4300.90.101	430 10	- GBox: ZF Ecosplit-3, Eaton
26.460 FDK, FDLK, FDLRK, FDRK H25, H29	01.01 -	D 2876 LF 05	4386.20.00	MFZ430	
26.460 FDLRS, FDLS, FDRS, FDS H63, H25, H29	06.01 -	D 2876 LF 07	4386.30.00	430WGTZ	
26.460 FD-TM, FDR-TM H25	01.01 -	D 2876 LF 12	8916.40.00	KZIZ - 5	
26.460 FNLRC, FNLLC, FNLLRC, FNLLRW, FNLLW, FNLRC H17, H20	04.00 -	D 2876 LF 13	4300.90.102	430 10	- GBox: ZF Ecosplit-3, Eaton
26.480 FDC, FDLC, FDLRC, FDRC, FNHLC, FVHLC H63, H25, H29	09.02 -	D 2876 LF 25	4386.20.00	MFZ430	
26.480 FDK, FDLK, FDLRK H25, H29, 12816cc	09.02 -		4386.30.00	430WGTZ	
26.480 FDLRS, FDLS, FDRS, FDS, FNHLS, FPHLS, FVHLS H63, H25, H29	09.02 -		8916.40.00	KZIZ - 5	
26.480 FD-TM H63, H25, 12816cc	09.02 -		4028.10.00	400 MFZ2/400X	- GBox: ZF Ecosplit-3 - Vehicles with double disc clutch - This part number includes one clutch disc
26.510 FDC, FDLC, FDLRC, FDRC H25, H29	01.01 -		4036.30.00	400 10 400 WGTZ	- GBox: ZF Ecosplit-3 - Vehicles with double disc clutch
26.510 FDS, FDLS, FDLS/M, FDRS, FDLRS H25, H29	01.01 -		8941.40.00	KZISZ-5	- GBox: ZF Ecosplit-3 - Vehicles with double disc clutch
26.510 FNLRC, FNLLC, FNLLRC, FNLLRW, FNLLW, FNLRC, FVLC H17, H20	12.00 -		4300.90.103	430 10	- GBox: ZF-AS-Tronic
26.530 FDC, FDLC, FDLRC, FDRC H25, H29	01.01 -		4386.20.00	MFZ430	
26.530 FDK, FDLK, FDLRK H25, H29	09.02 -		4386.30.00	430WGTZ	
26.530 FDLRS, FDLS, FDRS, FDS H25, H29	01.01 -		8939.40.00	KZISZ - 5	
28.460 FNLRC, FNLLC, FNLRC H87, H86	09.02 -		4300.90.104	430 10	- GBox: ZF-AS-Tronic - Use release fork with rollers
28.460 FNLS, FNLRS H86	09.02 -		4386.20.00	MFZ430	
28.480 FNLRC, FNLLC, FNLRC H87, H86	09.02 -		4386.30.00	430WGTZ	
28.480 FNLS, FNLRS H86	09.02 -		8939.40.00	KZISZ - 5	
28.510 FNLRC, FNLLC, FNLRC H87, H86	09.02 -		4300.90.105	430 10	- GBox: ZF-AS-Tronic - Use release fork with rollers
28.510 FNLS, FNLRS H86	09.02 -		4386.20.00	MFZ430	
28.530 FNLRC, FNLLC, FNLRC H87, H86	09.02 -		4386.30.00	430WGTZ	
28.530 FNLS, FNLRS H86	09.02 -		8939.40.00	KZISZ - 5	
33.460 FDC, FDLC, FDLRC, FDRC H25, H28, H62, H29	09.02 -		43461.30.00	430 10 430WGTZ	- GBox: ZF 16S-151/181 - For PTO
33.460 FDK, FDLK, FDRK H25, H28, H29, H62	09.02 -		8950.40.00	KZIZ-6	- GBox: ZF 16S-151/181 - For PTO
33.460 FDLRS, FDLS, FDRS, FDS H28, H25, H29, H62	09.02 -				
33.460 FD-TM, FDR-TM H25	09.02 -				
33.480 FDC, FDLC, FDRC, FDLRC H25, H28, H62, H29	09.02 -				
33.480 FDK, FDLK, FDRK H25, H28, H29, H62	09.02 -				
33.480 FDLRS, FDLS, FDRS, FDS H28, H25, H62, H29	09.02 -				
32.360 FFD-TM, FFFDR-TM H36, H48	01.02 -	D 2866 LF27	4300.90.20	430 10	- GBox: Ecosplit 3
			4319.20.00	MFZ430	
			4346.30.00	430WGTZ	
			8916.40.00	KZIZ - 5	
			4300.90.13	430 10	- GBox: AS-Tronic - Use release fork with cam
			4319.20.00	MFZ430	
			4346.30.00	430WGTZ	
			8919.40.00	KZISZ - 5	

Vehicle list

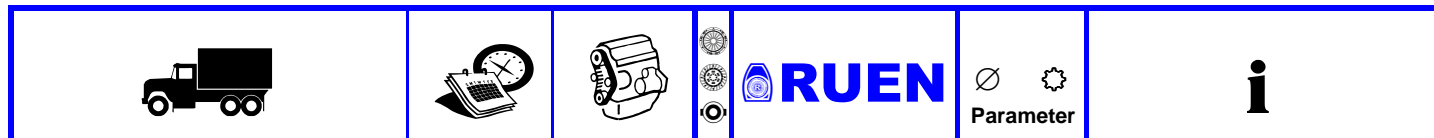







MAN

TGA 03.00 -



33.360 FDC, FDLG, FDRG, FDLRC H25, H28, H29, H62 33.360 FDK, FDK-WW, FDLK, FDRK-WW H25, H28, H29, H62 33.360 FDLRS, FDLS, FDRS, FDS H28, H25, H62, H29 33.360 FD-TM, FDR-TM, FDC-TM, FDRG-TM H25 33.410 FDC, FDLG, FDLRC, FDRG H25, H28, H29, H62 33.410 FDK, FDK-WW, FDLK, FDRK-WW H25, H28, H62, H29 33.410 FDLRS, FDLS, FDRS, FDS H28, H25, H29, H62 33.410 FD-TM, FDR-TM H25	10.00 -	D 2866 LF27	4300.90.20	430 10	- GBox: ZF Ecosplit-3
	01.01 -	D 2866 LF28	4319.20.00	MFZ430	
		D 2866 LF32	4346.30.00	430WGTZ	
	10.00 -	D 2866 LF37	8916.40.00	KZIZ - 5	
	01.01 -		4300.90.52	430 10	- GBox: ZF Ecosplit-3
	10.00 -		4319.20.00	MFZ430	
			4346.30.00	430WGTZ	
	10.00 -		8916.40.00	KZIZ - 5	
	10.00 -		4028.10.00	400	- GBox: ZF Ecosplit-3 - Vehicles with double disc clutch - This part number includes one clutch disc
	10.00 -		4036.30.00	400 10	- GBox: ZF Ecosplit-3 - Vehicles with double disc clutch
10.00 -		8941.40.00	400 WGTZ	- GBox: ZF Ecosplit-3 - Vehicles with double disc clutch	
			4300.90.13	430 10	- GBox: AS-Tronic - Use release fork with cam
			4319.20.00	MFZ430	
			4346.30.00	430WGTZ	
			8919.40.00	KZISZ - 5	
			4300.90.56	430 10	- GBox: AS-Tronic - Use release fork with rollers
			4319.20.00	MFZ430	
			4346.30.00	430WGTZ	
			8939.40.00	KZISZ - 5	
			43461.30.00	430 10	- GBox: ZF 16S-151/181 - For PTO
			8950.40.00	430WGTZ	- GBox: ZF 16S-151/181 - For PTO
41.530 FVDS, FVDLS H94	09.02 -	D 2876 LF 13	4300.90.101	430 10	- GBox: ZF Ecosplit-3
			4386.20.00	MFZ430	
			4386.30.00	430WGTZ	
			8916.40.00	KZIZ - 5	
			4300.90.102	430 10	- GBox: ZF Ecosplit-3
			4386.20.00	MFZ430	
			4386.30.00	430WGTZ	
			8916.40.00	KZIZ - 5	
			4028.10.00	400	- GBox: ZF Ecosplit-3 - Vehicles with double disc clutch - This part number includes one clutch disc
			4036.30.00	400 10	- GBox: ZF Ecosplit-3 - Vehicles with double disc clutch
	400 WGTZ	- GBox: ZF Ecosplit-3 - Vehicles with double disc clutch			
8941.40.00	KZISZ-5	- GBox: ZF Ecosplit-3 - Vehicles with double disc clutch			
4300.90.103	430 10	- GBox: AS-Tronic			
4386.20.00	MFZ430				
4386.30.00	430WGTZ				
8919.40.00	KZISZ - 5				
4300.90.104	430 10	- GBox: AS-Tronic - Use release fork with rollers			
4386.20.00	MFZ430				
4386.30.00	430WGTZ				
8939.40.00	KZISZ - 5				
4300.90.105	430 10	- GBox: AS-Tronic - Use release fork with rollers			
4386.20.00	MFZ430				
4386.30.00	430WGTZ				
8939.40.00	KZISZ - 5				

Vehicle list

			 RUEN	 Parameter	
---	---	---	--	--	---

MAN

TGA 03.00 -

41.660 FVDS, FVDLS H95	09.02 -	D 2840 LF25	 4028.10.00	400 MFZ2/400X	- GBox: ZF Ecosplit-3 - Vehicles with double disc clutch - This part number includes one clutch disc
			 4036.30.00	400 10 400 WGTZ	- GBox: ZF Ecosplit-3 - Vehicles with double disc clutch
			 8941.40.00	KZISZ-5	- GBox: ZF Ecosplit-3 - Vehicles with double disc clutch

Vehicle list



MAN

TGA 03.00 -

18.360 FLLRS, FLLS, FLRS, FLS, FLS-TS H06, H13, H10, H08, H65	01.06 -	D 2066 LF 01	4300.90.52	430 10	- GBox: ZF Ecosplit-3
18.400 FLS, FLLS, FLRS, FLLRS, FLS-TS H06, H13, H10, H08, H65	10.05 -	D 2066 LF 02	4319.20.00	MFZ430	
18.440 FLLRS, FLLS, FLRS, FLS, FLS-TS H06, H13, H10, H08	09.05 -	D 2066 LF 03	4346.30.00	430WGTZ	
19.350 FLRS, FLS, FRS, FS HW7, H64, HW1	05.04 -	D 2066 LF 04	8916.40.00	KZIZ - 5	
19.360 FLRS, FLS, FRS, FS H43, H60	05.04 -	D 2066 LF 06	4300.90.56	430 10	- GBox: AS-Tronic
19.360 FLRS, FLS, FRS, FS HW7, HW5, H64, HW1	05.04 -	D 2066 LF 07	4319.20.00	MFZ430	
19.390 FLRS, FLS, FRS, FS HW7, H64, HW1	05.04 -	D 2066 LF 11	4346.30.00	430WGTZ	
19.400 FLRS, FLS, FRS, FS HW7, HW5, H64, HW1	05.04 -	D 2066 LF 12	8939.40.00	KZISZ - 5	
19.410 FRS, FS H43, H60	05.04 -	D 2066 LF 13	43461.30.00	430 10	- GBox: ZF 16S-151/181
19.430 FLRS, FLS, FRS, FS HW7, H64, HW1	05.04 -	D 2066 LF 14		430WGTZ	- For PTO
24.350, 24.360 FLLRW, FNLLC, FNLLRC, FNLLRW, FNLLW H45	05.04 -	D 2066 LF 23	8950.40.00	KZIZ-6	- GBox: ZF 16S-151/181
24.350, 24.360 FPLS, FPLRS H24	02.04 -	D 2066 LF 25			- For PTO
24.390, 24.400 FLLRW, FNLLC, FNLLRC, FNLLW, FNLLRC H45	05.04 -	D 2066 LF 26			
24.390, 24.400 FPLS, FPLRS H24	05.04 -	D 2066 LF 27			
24.430, 24.440 FNLLC, FNLLRC, FNLLW, FNLLRC, FNLLRW H45	05.04 -	D 2066 LF 31			
24.430, 24.440 FPLS, FPLRS H24	05.04 -	D 2066 LF 32			
26.310 FDAC, FDARC, FDH, FDHC H47, H56	01.04 -	D 2066 LF 33			
26.310 FDAK, FDHK H56	01.04 -	D 2066 LF 35			
26.310 FDARS, FDAS, FDHS H47, H56	01.04 -	D 2066 LF 36			
26.310 FVLC H23	09.03 -	D 2066 LF 37			
26.310, 26.320 FDAK, FDHK H47, H56	06.05 -	D 2066 LF 38			
26.310, 26.320 FDAS, FDHS H47	06.05 -	D 2066 LF 39			
26.310, 26.320 FDH, FDHC, FDHC/M H47	06.05 -	D 2866 LF26			
26.310, 26.320 FDH-TM H47	06.05 -	D 2866 LF32			
26.310, 26.320 FVLC H24	02.04 -	D 2866 LF36			
26.310, 26.320 FVL-KO H24	02.04 -	D 2866 LF37			
26.350 FDAC, FDHC H47, H56	02.04 -				
26.350 FDAK H56	02.04 -				
26.350 FDAS, FDHS H47, H56	02.04 -				
26.350 FDHC, FDHC/M H47	04.05 -				
26.350 FDLRC-WW H67	05.04 -				
26.350 FDLRS, FDLRS, FDLRS/M, FDLRS-WW HV2, H67, H30	05.04 -				
26.350 FVHLC H42	06.05 -				
26.350 FVHLS H42	07.05 -				
26.350 FVLC H24, 6x2/4	01.04 -				
26.350 FVLS, FVLR H24	07.05 -				
26.350, 26.360 FDAK, FDALK, FDHK, FDHLK H47, H56, HH1	05.04 -				
26.350, 26.360 FDARS, FDAS, FDHLS, FDHS H47, HH1	05.04 -				
26.350, 26.360 FDH-TM H47	05.04 -				
26.350, 26.360 FVL-KO H24	01.04 -				

Vehicle list



MAN

TGA 03.00 -

26.360 FDAC, FDARC, FDHC, FDHLC H47, H56, HH1	06.04 -	D 2066 LF 01		4300.90.52	430 10	- GBox: ZF Ecosplit-3
26.360 FDAK, FDARK H56	06.04 -	D 2066 LF 02		4319.20.00	MFZ430	
26.360 FDARS, FDAS, FDHLS, FDHS H56	06.04 -	D 2066 LF 07		4346.30.00	430WGTZ	
26.360 FDHC, FDHLC H47, HH1	06.04 -	D 2066 LF 11		8916.40.00	KZIZ - 5	
26.360 FDLC-WW, FDLRC H67	05.04 -	D 2066 LF 12		4300.90.56	430 10	- GBox: AS-Tronic
26.360 FDLS, FDLRS-WW, FNHLS H35, H67	09.02 -	D 2066 LF 31		4319.20.00	MFZ430	
26.360 FDS, FDLS, FNLS, FNLRS, FPLS, FPLRS, FVLS, FVLRS H17, H20, H25, H23	05.04 -	D 2066 LF 32		4346.30.00	430WGTZ	
26.360 FVHLC H42	12.00 -	D 2066 LF 36		8939.40.00	KZISZ - 5	
26.360 FVHLS H42	12.00 -	D 2066 LF 37		43461.30.00	430 10	- GBox: ZF 16S-151/181
26.360 FVLC H24	04.06 -	D 2066 LF 38			430WGTZ	- For PTO
26.360 FVLS, FVLRS H24	04.06 -	D 2866 LF27		8950.40.00	KZIZ-6	- GBox: ZF 16S-151/181
26.390 FDAC, FDALC, FDHC H47, H56, H82	04.06 -	D 2866 LF28				- For PTO
26.390 FDAK, FDALK, FDHK H56, H82	04.06 -	D 2866 LF32				
26.390 FDALS, FDAS, FDALS, FDHS H56, H82	04.06 -	D 2866 LF37				
26.390 FDH-TM H47	01.04 -					
26.390 FVLC H24	02.04 -					
26.390 FVLS, FVLRS H24	02.04 -					
26.390, 26.400 FDAK, FDALK, FDHK, FDHLK H47, H56, H82, HH1	07.05 -					
26.390, 26.400 FDALS, FDAS, FDHLS, FDHS H47, HH1	06.05 -					
26.390, 26.400 FDHC, FDHC/M, FDHLC H47, HH1	06.05 -					
26.390, 26.400 FVL-KO H24	06.05 -					
26.400 FDAC, FDALC, FDHC, FDHLC H47, H56, H82, HH1	02.04 -					
26.400 FDAK, FDALK, FDHK, FDHLK H56, H82	01.04 -					
26.400 FDALS, FDAS, FDHLS, FDHS H56, H82	01.04 -					
26.400 FDH-TM H47	01.04 -					
26.400 FVLC H24	04.06 -					
26.400 FVLS, FVLRS H24	04.06 -					
26.410 FVLC H23	04.06 -					
26.410 FVLS, FVLRS H23	09.03 -					
26.430 FDAC, FDALC, FDHC H47, H56, H82	07.05 -					
26.430 FDAK, FDALK, FDHK H56, H82	01.04 -					
26.430 FDALS, FDAS, FDHLS, FDHS H56, H82	01.04 -					
26.430 FDLS, FDLS/M, FDLRS-WW HV2, H67	01.04 -					
26.430 FVL-KO H24	02.04 -					
26.430 FVLS, FVLRS H24	02.04 -					
26.430, 26.440 FDAK, FDALK, FDHK, FDHLK H47, H56, H82, HH1	12.00 -					
26.430, 26.440 FDALS, FDAS, FDHLS, FDHS H47, HH1	07.05 -					
26.430, 26.440 FDHC, FDHC/M, FDHLC H47, HH1	07.05 -					
26.430, 26.440 FDH-TM H47	06.05 -					
26.440 FDAC, FDALC, FDHC, FDHLC H47, H56, H82, HH1	06.05 -					
26.440 FDAK, FDALK H56, H82	06.05 -					
26.440 FDALS, FDAS, FDHLS, FDHS H56, H82	09.05 -					
	01.04 -					
	01.04 -					

Vehicle list



MAN

TGA 03.00 -

26.440 FVL-KO H24	09.05 -	D 2066 LF 01		4300.90.52	430 10	- GBox: ZF Ecosplit-3
26.440 FVLS, FVLR H24	09.05 -	D 2066 LF 02		4319.20.00	MFZ430	
28.310 FNLC, FNLLC 71	09.02 -	D 2066 LF 03		4346.30.00	430WGTZ	
28.310 FNLC, FNLLC, FNLRC H89, H85	09.02 -	D 2066 LF 04		8916.40.00	KZIZ - 5	
28.310 FNLS, FNLRS H89	06.04 -	D 2066 LF 11		4300.90.56	430 10	- GBox: AS-Tronic
28.310, 28.320 FNLC, FNLLC,	07.06 -	D 2066 LF 12		4319.20.00	MFZ430	
FNLL-LE, FNLLR-LE H74, H99, H75	07.06 -	D 2066 LF 13		4346.30.00	430WGTZ	
28.320 FNLC, FNLLC, FNLLRC,	07.06 -	D 2066 LF 14		8939.40.00	KZISZ - 5	
FNLLR-LE H74, H89, H99	07.06 -	D 2066 LF 25		43461.30.00	430 10	- GBox: ZF 16S-151/181
28.320 FNLC, FNLLC, FNLLRC,	07.06 -	D 2066 LF 26			430WGTZ	- For PTO
FNLLR-LE H74, H89, H99	06.04 -	D 2066 LF 27		8950.40.00	KZIZ-6	- GBox: ZF 16S-151/181
28.320 FNLC, FNLLC, FNLRC H89, H85	06.04 -	D 2066 LF 28				- For PTO
28.320 FNLS, FNLRS H89	06.04 -	D 2066 LF 31				
28.350 FANLC H84	07.06 -	D 2066 LF 32				
28.350 FANLK H84	07.06 -	D 2066 LF 33				
28.350 FNLS, FNLRS HV7, H89, HV4	02.04 -	D 2066 LF 36				
28.350, 28.360 FNLC, FNLLC,	07.06 -	D 2066 LF 37				
FNLL-LE, FNLLR-LE H74, H89, H99,	07.06 -	D 2066 LF 38				
H75, H85	06.04 -	D 2066 LF 39				
28.350, 28.360 FNLC, FNLLC, FNLRC,	06.04 -	D 2866 LF26				
FNLL-LE, FNLLR-LE H74, HV7, H89,	06.04 -	D 2866 LF27				
H99, H75, H85, HV4	06.04 -	D 2866 LF28				
28.360 FANLC H81	07.06 -					
28.360 FANLC H84	07.06 -					
28.360 FANLK H81	07.06 -					
28.360 FANLK H84	07.06 -					
28.360 FNLC, FNLLC H71	09.02 -					
28.360 FNLS, FNLRS H89	04.06 -					
28.390 FANLC H84	07.06 -					
28.390 FANLK H84	07.06 -					
28.390 FNLC, FNLLC H74,H75	07.06 -					
28.390 FNLS, FNLRS HV7, H89, HV4	05.04 -					
28.390, 28.400 FNLC, FNLLC, FNLRC	06.04 -					
H74, HV7, H89, H75, H85, HV4	06.04 -					
28.400 FANLC H84	07.06 -					
28.400 FANLK H74	07.06 -					
28.400 FNLS, FNLRS H89	04.06 -					
28.410 FANLC H81	07.06 -					
28.410 FANLK H81	07.06 -					
28.410 FNLC, FNLLC H71	09.02 -					
28.430 FANLC H84	07.06 -					
28.430 FANLK H84	07.06 -					
28.430, 28.440 FNLC, FNLLC, FNLRC	06.04 -					
H74, HV7, H89, H75, H85, HV4	06.04 -					
28.440 FANLC H84	07.06 -					
28.440 FANLK H84	07.06 -					
28.440 FNLS, FNLRS H89	09.05 -					
32.350, 32.360 FFDC, FFDLC,	05.04 -					
FFDLRC, FFDRC H49, HV8	02.04 -					
32.350, 32.360 FFD-TM, FFD-TM H49	05.04 -					
32.390, 32.400 FFDRC H49, HV8	05.04 -					
32.390, 32.400 FFD-TM, FFD-TM H49	05.04 -					
32.430, 32.440 FFDRC H49	05.04 -					
32.430, 32.440 FFD-TM, FFD-TM H49	05.04 -					

Vehicle list



MAN

TGA 03.00 -

33.350 FDC-TM, FDRC-TM HW2	09.07 -	D 2066 LF 01	4300.90.52	430 10	- GBox: ZF Ecosplit-3
33.350, 33.360 FDAC, FDARC, FDHC H47, H56, HW4	06.05 -	D 2066 LF 02	4319.20.00	MFZ430	
33.350, 33.360 FDAK, FDARK, FDHK H47, H56, HW4	06.05 -	D 2066 LF 03	4346.30.00	430WGTZ	
33.350, 33.360 FDAK, FDARK, FDHK H47, H56, HW4	06.05 -	D 2066 LF 04	8916.40.00	KZIZ - 5	
33.350, 33.360 FDARS, FDAS, FDHS H47, H56, HW4	06.05 -	D 2066 LF 06	4300.90.56	430 10	- GBox: AS-Tronic
33.350, 33.360 FDARS, FDAS, FDHS H47, H56, HW4	06.05 -	D 2066 LF 07	4319.20.00	MFZ430	
33.360 FDC-TM, FDRC-TM, FDR-TM, FD-TM HW2	09.07 -	D 2066 LF 11	4346.30.00	430WGTZ	
33.360 FDC-TM, FDRC-TM, FDR-TM, FD-TM HW2	09.07 -	D 2066 LF 12	8939.40.00	KZISZ - 5	
33.390, 33.400 FDAC, FDHC H47, H56, HW4	06.05 -	D 2066 LF 13	43461.30.00	430 10	- GBox: ZF 16S-151/181
33.390, 33.400 FDAC, FDHC H47, H56, HW4	06.05 -	D 2066 LF 31		430WGTZ	- For PTO
33.390, 33.400 FDAK, FDARK, FDHK H47, H56, HW4	06.05 -	D 2066 LF 32	8950.40.00	KZIZ-6	- GBox: ZF 16S-151/181
33.390, 33.400 FDAK, FDARK, FDHK H47, H56, HW4	06.05 -	D 2066 LF 33			- For PTO
33.390, 33.400 FDARS, FDAS, FDHS H47, H56, HW4	06.05 -	D 2066 LF 35			
33.390, 33.400 FDARS, FDAS, FDHS H47, H56, HW4	06.05 -	D 2066 LF 36			
33.390, 33.400 FDC-TM, FDRC-TM HW2	09.07 -	D 2066 LF 37			
33.430, 33.440 FDAC, FDALC, FDHC H47, H56, H82, HW4	06.05 -	D 2066 LF 38			
33.430, 33.440 FDAC, FDALC, FDHC H47, H56, H82, HW4	06.05 -	D 2066 LF 39			
33.430, 33.440 FDAK, FDALK, FDARK, FDHK H47, H56, H82, HW4	06.05 -	D 2866 LF27			
33.430, 33.440 FDAK, FDALK, FDARK, FDHK H47, H56, H82, HW4	06.05 -	D 2866 LF28			
33.430, 33.440 FDALS, FDARS, FDAS, FDHS H47, H56, H82, HW4	06.05 -				
35.310, 35.320 FFDC, FFDLC H37, H41	02.04 -				
35.310, 35.320 FFDK, FFDLK H37, H41	02.04 -				
35.310, 35.320 FFD-TM H37	02.04 -				
35.350 FFDHK, FFDHLK H59, H50	07.06 -				
35.350 FFDH-TM H50	07.06 -				
35.350 FFNLC H90	07.06 -				
35.350, 35.360 FFDC, FFDRC, FFDLC H37, HH4, H41	02.04 -				
35.350, 35.360 FFDK, FFDRC, FFDLC H37, H41	02.04 -				
35.350, 35.360 FFDK, FFDRC, FFDLC H37, H41	02.04 -				
35.350, 35.360 FFD-TM H37	02.04 -				
35.360 FFDK, FFDHK, FFDHLK H59, H50	07.06 -				
35.360 FFDH-TM H50	07.06 -				
35.360 FFNHLK	07.06 -				
35.360 FFNLC H88	07.06 -				
35.360 FFNLC H90	07.06 -				
35.390 FDNLC H92	07.06 -				
35.390 FFDK, FFDHK, FFDHLK H93, H59, H50	02.04 -				
35.390 FFDK, FFDHK, FFDHLK H93, H59, H50	07.06 -				
35.390 FFDH-TM H50	07.06 -				
35.390 FFNLC H90	07.06 -				
35.390, 35.400 FFDC, FFDRC, FFDLC H37, HW3, H41	02.04 -				
35.390, 35.400 FFDK, FFDRC, FFDLC H37, H41	02.04 -				
35.390, 35.400 FFD-TM H37	02.04 -				
35.400 FDNLC H92	07.06 -				
35.400 FFDK, FFDHK, FFDHLK H93, H59, H50	02.04 -				
35.400 FFDK, FFDHK, FFDHLK H93, H59, H50	07.06 -				
35.400 FFDH-TM H50	07.06 -				
35.400 FFNHLK HH4	11.06 -				
35.400 FFNLC H90	07.06 -				
35.410 FDNLC H91	07.06 -				
35.410 FFDK, FFDHK, FFDHLK H93, H59, H50	07.06 -				
35.410 FFDK, FFDHK, FFDHLK H93, H59, H50	07.06 -				
35.410 FFDH-TM H50	07.06 -				

Vehicle list

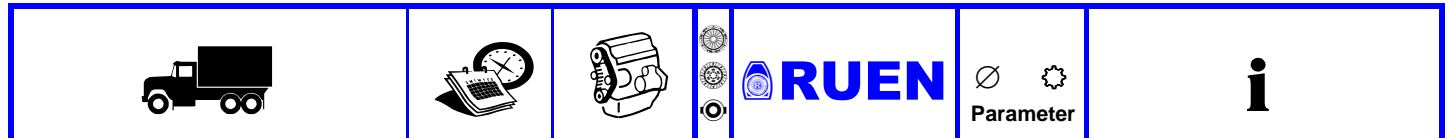

MAN

TGA		03.00 -				
35.410 FFNLC H88	07.06 -	D 2066 LF 01	4300.90.52	430 10	- GBox: ZF Ecosplit-3	
35.430 FDNLC H92	07.06 -	D 2066 LF 02	4319.20.00	MFZ430		
35.430 FFDAC, FFDHK, FFDHLK H93, H59, H50	07.06 -	D 2066 LF 03	4346.30.00	430WGTZ		
35.430 FFDAC, FFDHK, FFDHLK HV6, H96	07.06 -	D 2066 LF 04	8916.40.00	KZIZ - 5		
35.430 FFDH-TM H50	07.06 -	D 2066 LF 06	4300.90.56	430 10	- GBox: AS-Tronic	
35.430 FFDH-TM H50	07.06 -	D 2066 LF 11	4319.20.00	MFZ430		
35.430 FFNLC H90	07.06 -	D 2066 LF 12	4346.30.00	430WGTZ		
35.430, 35.440 FFDC, FFDRC, FFDLC H37, H41	02.04 -	D 2066 LF 13	8939.40.00	KZISZ - 5		
35.430, 35.440 FFDK, FFDRC, FFDLC H37, H41	02.04 -	D 2066 LF 31	43461.30.00	430 10	- GBox: ZF 16S-151/181	
35.430, 35.440 FFDK, FFDRC, FFDLC H37, H41	02.04 -	D 2066 LF 32		430WGTZ	- For PTO	
35.430, 35.440 FFD-TM H37	02.04 -	D 2066 LF 33	8950.40.00	KZIZ-6	- GBox: ZF 16S-151/181	
35.440 FDNLC H92	07.06 -	D 2066 LF 35			- For PTO	
35.440 FFDAC, FFDHK, FFDHLK H59, H50, H96	07.06 -	D 2066 LF 36				
35.440 FFDH-TM H50	07.06 -	D 2066 LF 37				
35.440 FFNHLK HH4	11.06 -	D 2066 LF 38				
35.440 FFNLC H90	07.06 -	D 2066 LF 39				
37.310 FFDC H38	12.04 -	D 2866 LF04				
37.310 FFDK H38	12.04 -	D 2866 LF26				
37.310 FFD-TM H38	12.04 -	D 2866 LF27				
37.310, 37.320 FFDC H39	12.04 -	D 2866 LF28				
37.310, 37.320 FFDK H39	12.04 -	D 2866 LF32				
37.310, 37.320 FFD-TM H39	12.04 -					
37.350, 37.360 FFDC H39	12.04 -					
37.350, 37.360 FFDK H39	12.04 -					
37.350, 37.360 FFD-TM H39	12.04 -					
37.360 FFDC H38	12.04 -					
37.360 FFDK H38	12.04 -					
37.360 FFD-TM H38	12.04 -					
37.390, 37.400 FFDC H39	12.04 -					
37.390, 37.400 FFDK H39	12.04 -					
37.390, 37.400 FFD-TM H39	12.04 -					
37.410 FFDC H38	12.04 -					
37.410 FFDK H38	12.04 -					
37.410 FFD-TM H38	12.04 -					
37.430, 37.440 FFDC H39	12.04 -					
37.430, 37.440 FFDK H39	12.04 -					
37.430, 37.440 FFD-TM H39	12.04 -					
39.390 FVNLC H69	07.06 -					
39.400 FVNLC H69	07.06 -					
39.430 FVNLC H69	07.06 -					
39.440 FVNLC H69	07.06 -					
40.390, 40.400 FDAK, FDARK H58	06.05 -					
40.390, 40.400 FDARS, FDAS H58	06.05 -					
40.390, 40.400 FDK, FDRK H34, H11	06.05 -					
40.390, 40.400 FDRS, FDS H34	06.05 -					
40.410 FDAK H57	04.04 -					
40.410 FDAS H57	04.04 -					
40.410 FDK H68, H33	04.04 -					
40.410 FDS H33	04.04 -					
40.430 FDK, FDRK H34	06.05 -					
40.430 FDRS, FDS H34	06.05 -					
40.430, 40.440 FDAK, FDARK H58	06.05 -					
40.430, 40.440 FDARS, FDAS H58	06.05 -					

Vehicle list



MAN

TGA 03.00 -

40.480 FDRS, FDS H34,H33	06.05 -	D 2066 LF 01	4300.90.52	430 10	- GBox: ZF Ecosplit-3
41.350 FFDC-TM, FFDRC-TM HW3	09.07 -	D 2066 LF 02	4319.20.00	MFZ430	
41.350, 41.360 FFD, FFDC, FFDRC HW3, H39, HW6	12.04 -	D 2066 LF 03	4346.30.00	430WGTZ	
41.350, 41.360 FFDC-TM, FFDRC-TM, FFD-TM D 2066 LF 38 (12/2004 -) 257 350 10518	12.04 -	D 2066 LF 06	8916.40.00	KZIZ - 5	
41.350, 41.360 FFDC-TM, FFDRC-TM, FFD-TM D 2066 LF 38 (12/2004 -) 257 350 10518	12.04 -	D 2066 LF 07	4300.90.56	430 10	- GBox: AS-Tronic
Mounting Instructions H39, HW6		D 2066 LF 11	4319.20.00	MFZ430	
41.350, 41.360 FFDK, FFDRK HW3, H39, HW6	12.04 -	D 2066 LF 12	4346.30.00	430WGTZ	
41.360 FFD HW6	12.08 -	D 2066 LF 13	8939.40.00	KZISZ - 5	
41.360 FFDC-TM, FDRC-TM HW3	09.07 -	D 2066 LF 31	43461.30.00	430 10	- GBox: ZF 16S-151/181
41.360 FFDC-TM, FFDRC-TM, FFD-TM H38	12.04 -	D 2066 LF 32		430WGTZ	- For PTO
41.360 FFDK, FFDRK H38,H46	09.03 -	D 2066 LF 33	8950.40.00	KZIZ-6	- GBox: ZF 16S-151/181
41.390 FFDAK HV6	12.04 -	D 2066 LF 36			- For PTO
41.390 FFDC-TM, FDRC-TM HW3	09.07 -	D 2066 LF 37			
41.390, 41.400 FFD, FFDC, FFDRC HW3, H39	12.04 -	D 2066 LF 38			
41.390, 41.400 FFDC-TM, FFDRC-TM, FFD-TM H39, HW6	12.04 -	D 2676 LF 02			
41.390, 41.400 FFDK, FFDRK HW3, H39, HW6	12.04 -	D 2676 LF 03			
41.400 FFD HW6	12.08 -	D 2676 LF 13			
41.400 FFDC-TM, FDRC-TM HW3	09.07 -	D 2866 LF27			
41.410 FFDAK H73	07.06 -	D 2866 LF28			
41.410 FFDAK H76	07.06 -	D 2866 LF32			
41.410 FFDC, FFDRC, FDRC H38,H46	09.03 -	D 2866 LF37			
41.410 FFDC-TM, FFDRC-TM, FFD-TM H38	12.04 -				
41.410 FFDK, FFDRK H38,H46	12.04 -				
41.430 FFDAK HV6, H96	12.04 -				
41.430 FFDAK H93	07.06 -				
41.430 FFDC-TM, FFDRC HW3	09.07 -				
41.430, 41.440 FFD, FFDC, FFDRC HW3,H39	12.04 -				
41.430, 41.440 FFDC-TM, FFDRC-TM, FFD-TM H39	12.04 -				
41.430, 41.440 FFDK, FFDRK HW3.H39	12.04 -				
41.440 FFDAK 93	07.06 -				
41.440 FFDAK 96	07.06 -				

Vehicle list



MAN

TGA 03.00 -

18.460 FAK	12.00 -	D 2676 LF 04		4300.90.101	430 10	- GBox: ZF Ecosplit-3
18.480 FAC, FARC H52	02.06 -	D 2676 LF 01		4386.20.00	MFZ430	
18.480 FAK, FAK-L, FALK, FALK-L, FHLK H52, H80, H22	02.06 -	D 2676 LF 02		4386.30.00	430WGTZ	
18.480 FALS, FARS, FAS, FHLS H52, H80, H22	02.06 -	D 2676 LF 03		8916.40.00	KZIZ - 5	
18.480 FLLRS, FLLS, FLRS, FLS, FLS-TS H06, H13, H10, H08	01.06 -	D 2676 LF 05		4300.90.102	430 10	- GBox: ZF Ecosplit-3
18.540 FLC, FLLC, FLLRC, FLLW, FLRC H06, H15, H10	08.06 -	D 2676 LF 11		4386.20.00	MFZ430	
18.540 FLLRS, FLLS, FLRS, FLS H06, H13, H10	08.06 -	D 2676 LF 12		4386.30.00	430WGTZ	
19.440 FLRS, FLS, FRS, FS HW7, HW5, H64, HW1	08.06 -	D 2676 LF 13		8916.40.00	KZIZ - 5	
19.460 FRS, FS H43, H60	08.06 -	D 2676 LF 14		4300.90.103	430 10	- GBox: AS-Tronic
19.480 FLRS, FLS, FRS, FS HW7, HW5, H64, HW1	02.06 -	D 2866 LF26		4386.20.00	MFZ430	
19.480 FRS, FS H43, H60	02.06 -	D 2876 LF 04		4386.30.00	430WGTZ	
19.480 FRS, FS H43, H60	05.04 -	D 2876 LF 07		8919.40.00	KZISZ - 5	
19.480 FRS, FS H43, H60	05.04 -	D 2876 LF 12		4300.90.104	430 10	- GBox: AS-Tronic
19.480 FLRS, FLS, FRS, FS HW7, HW5, H64, HW1	02.06 -	D 2876 LF 13		4386.20.00	MFZ430	
19.480 FRS, FS H43, H60	02.06 -	D 2876 LF 25		4386.30.00	430WGTZ	
19.480 FS/M, FRS/M-WW H64, HW1	05.04 -			8939.40.00	KZISZ - 5	
24.480 FNLLC, FNLLRC, FNLLRW, FNLLW H45	02.06 -			4300.90.105	430 10	- GBox: AS-Tronic
24.480 FPLS, FPLRS H23	01.06 -			4386.20.00	MFZ430	
24.480 FPLS, FPLRS H24	07.05 -			4386.30.00	430WGTZ	
24.480 FPLS, FPLRS H24	01.06 -			8939.40.00	KZISZ - 5	
24.530 FPLS, FPLRS H23	01.06 -			43461.30.00	430 10	- GBox: ZF 16S-151/181
24.540 FNLLC, FNLLW H45	07.05 -				430WGTZ	- For PTO
26.440 FDC, FDLC, FDLRC, FDRC, FNHLC H67	01.06 -			8950.40.00	KZIZ-6	- GBox: ZF 16S-151/181
26.440 FDLRS, FDLS, FDRS, FDS, FNHLS, FPHLS, FVHLS H67	02.06 -					- For PTO
26.480 FDAC, FDALC, FDARC, FDHC, FDHLC H47, H56, H82, HH1	02.06 -					
26.480 FDK, FDALK H56, H82	02.06 -					
26.480 FDK, FDALK, FDHK, FDHLK H47, H56, H82, HH1	02.06 -					
26.480 FDALS, FDARS, FDAS, FDHLS, FDHS H47, HH1	02.06 -					
26.480 FDALS, FDARS, FDAS, FDHLS, FDHS H56, H82	02.06 -					
26.480 FDHC, FDHC/M, FDHLC H47, HH1	02.06 -					
26.480 FDH-TM H47	02.06 -					
26.480 FNLC, FNLLC, FNLLRC, FNLLW, FNLRC, FVLC H18, H24, H21, HV1	02.06 -					
26.530 FDAC, FDALC H55, H72	08.06 -					
26.530 FDK, FDALK H55, H72	07.06 -					
26.530 FDAS, FDALS H55, H72	09.02 -					
26.540 FNLC, FNLLC, FNLLRC, FNLLW, FNLRC H18, H21	07.06 -					
27.440 FDS, FDLS, FDRS, FDLRS	08.06 -					
28.390 FNLLC H81	10.08 -					
28.480 FANLC H84	07.06 -					
28.480 FANLC H81	07.06 -					
28.480 FANLC H81	07.06 -					
28.480 FANLC H81	07.06 -					
28.480 FANLC H84	07.06 -					
28.480 FNLC, FNLRC, FNLLC HV7, H89, H85, HV4	07.06 -					
28.480 FNLS, FNLRS HV7, H89, HV4	02.06 -					
28.530 FANLC H81	07.06 -					
28.530 FANLC H81	07.06 -					

Vehicle list



MAN

TGA 03.00 -

28.540 FNLC, FNLLC H89,H85	08.06 -	D 2676 LF 04	4300.90.101	430 10	- GBox: ZF Ecosplit-3
28.540 FNLS H89	08.06 -	D 2676 LF 01	4386.20.00	MFZ430	
32.480 FFDRC H49	02.06 -	D 2676 LF 02	4386.30.00	430WGTZ	
32.480 FFD-TM, FFDR-TM H49	02.06 -	D 2676 LF 03	8916.40.00	KZIZ - 5	
33.440 FDAC, FDALC, FDHC HW4	06.05 -	D 2676 LF 05	4300.90.102	430 10	- GBox: ZF Ecosplit-3
33.440 FDAK, FDALK, FDARK, FDHK HW4	06.05 -	D 2676 LF 13	4386.20.00	MFZ430	
33.440 FDALS, FDARS, FDAS, FDHS HW4	06.05 -	D 2866 LF26	4386.30.00	430WGTZ	
33.440 FDC, FDLC, FDRC H66, HW2	06.05 -	D 2866 LF27	8916.40.00	KZIZ - 5	
33.440 FDC-TM, FDRC-TM HW2	09.07 -	D 2866 LF28	4300.90.103	430 10	- GBox: AS-Tronic
33.440 FDK, FDLK, FDRK H66,HW2	06.05 -	D 2876 LOH 28	4386.20.00	MFZ430	
33.440 FDLs, FDRS, FDS H66, HW8, HW2, HW9	06.05 -	D 2876 LF 04	4386.30.00	430WGTZ	
33.460 FDAC H54	09.02 -	D 2876 LF 05	8919.40.00	KZISZ - 5	
33.460 FDAK H54	09.02 -	D 2876 LF 07	4300.90.104	430 10	- GBox: AS-Tronic
33.460 FDAS H54	09.02 -	D 2876 LF 12	4386.20.00	MFZ430	
33.480 FDAC, FDALC, FDARC, FDHC H47, H56, H82, HW4	02.06 -	D 2876 LF 13	4386.30.00	430WGTZ	
33.480 FDAK, FDALK, FDARK, FDHK H47, H56, H82, HW4	02.06 -		8939.40.00	KZISZ - 5	
33.480 FDALS, FDARS, FDAS, FDHS H47, H56, H82, HW4	02.06 -		43461.30.00	430 10	- GBox: ZF 16S-151/181 - For PTO
33.480 FDC-TM, FDRC-TM, FD-TM HW2	09.07 -		8950.40.00	KZIZ-6	- GBox: ZF 16S-151/181 - For PTO
33.530 FDAC, FDALC H55,H72	09.02 -				
35.310 FFDC, FFDLC H40, H36	06.03 -				
35.310 FFDK, FFDLK H40, H36	06.03 -				
35.310 FFD-TM H36	11.03 -				
35.360 FFDC, FFDLC, FFDRC H40,H36	10.03 -				
35.360 FFDK, FFDLK, FFDRC H40, H36	10.03 -				
35.360 FFD-TM H36	11.03 -				
35.410 FFDC, FFDLC H40, H36	10.03 -				
35.410 FFDK, FFDLK H40,H36	10.03 -				
35.410 FFD-TM H36	11.03 -				
35.460 FFDC, FFDLC H40, H36	10.03 -				
35.460 FFDK, FFDLK H40, H36	10.03 -				
35.460 FFD-TM H36	11.03 -				
35.460 FFNLC H88	07.06 -				
35.480 FDNLC H91	07.06 -				
35.480 FDNLC H92	07.06 -				
35.480 FFDAK H76	07.06 -				
35.480 FFDAK HV6, H96	07.06 -				
35.480 FFDAK, FFDHK, FFDHLK H73	07.06 -				
35.480 FFDAK, FFDHK, FFDHLK H93, H59, H50	07.06 -				
35.480 FFDARS H76	07.06 -				
35.480 FFDC, FFDLC H40,H36	07.06 -				
35.480 FFDC, FFDLC H37, H41	02.04 -				
35.480 FFDH-TM H50	07.06 -				

Vehicle list



MAN

TGA 03.00 -

35.480 FFDK, FFDLK H40,H36	10.03 -	D 2676 LF 04	4300.90.101	430 10	- GBox: ZF Ecosplit-3
35.480 FFDK, FFDLK H37,H41	02.04 -	D 2676 LF 01	4386.20.00	MFZ430	
35.480 FFD-TM H36	11.03 -	D 2676 LF 02	4386.30.00	430WGTZ	
35.480 FFD-TM H37	02.04 -	D 2676 LF 03	8916.40.00	KZIZ - 5	
35.480 FFNHLC HH4	11.06 -	D 2676 LF 05	4300.90.102	430 10	- GBox: ZF Ecosplit-3
35.480 FFNLC H90	07.06 -	D 2876 LF 04	4386.20.00	MFZ430	
35.480 FFNLC H88	07.06 -	D 2876 LF 05	4386.30.00	430WGTZ	
35.530 FDNLC H91	04.04 -	D 2876 LF 07	8916.40.00	KZIZ - 5	
35.530 FFDK H73	07.06 -	D 2876 LF 12	4300.90.103	430 10	- GBox: AS-Tronic
	07.06 -	D 2876 LF 13	4386.20.00	MFZ430	
35.530 FFDC, FFDLC H40, H36	04.04 -	D 2876 LF 25	4386.30.00	430WGTZ	
35.530 FFDK, FFDLK H40,H36	04.04 -		8919.40.00	KZISZ - 5	
35.530 FFD-TM H36	04.04 -		4300.90.104	430 10	- GBox: AS-Tronic
35.530 FFNLC H88	07.06 -		4386.20.00	MFZ430	
37.460 FFDC H38	12.04 -		4386.30.00	430WGTZ	
37.460 FFDK H38	12.04 -		8939.40.00	KZISZ - 5	
37.460 FFD-TM H38	12.04 -		4300.90.105	430 10	- GBox: AS-Tronic
37.480 FFDC H38	12.04 -		4386.20.00	MFZ430	
37.480 FFDC H39	02.06 -		4386.30.00	430WGTZ	
37.480 FFDK H38	12.04 -		8939.40.00	KZISZ - 5	
37.480 FFDK H39	02.06 -		43461.30.00	430 10	- GBox: ZF 16S-151/181
37.480 FFD-TM H38	12.04 -			430WGTZ	- For PTO
37.480 FFD-TM H39	02.06 -		8950.40.00	KZIZ-6	- GBox: ZF 16S-151/181
37.530 FFDC H38	12.04 -				- For PTO
37.530 FFDK H38	12.04 -				
37.530 FFD-TM H38	12.04 -				
37.530 FVDS, FVDLS	07.06 -				
39.480 FVNLC H69	07.06 -				
40.440 FDAK, FDARK H58	06.05 -				
40.440 FDARS, FDAS H58	06.05 -				
40.440 FDK, FDRK H34,H11	06.05 -				
40.440 FDRS, FDS H34	06.05 -				
40.460 FDAK H57	04.04 -				
40.460 FDAS H57	04.04 -				
40.460 FDK H33	04.04 -				
40.460 FDS H33	04.04 -				
40.480 FDAK, FDARK H57	04.04 -				
40.480 FDAK, FDARK H58	06.05 -				
40.480 FDARS, FDAS H57,H58	04.04 -				
40.480 FDK, FDRK H33	04.04 -				
40.480 FDK, FDRK H34,H11	06.05 -				
40.480 FDRS, FDAS H58	06.05 -				
40.480 FDRS, FDS H33	04.04 -				

Vehicle list



MAN

TGA 03.00 -

41.440 FFD, FFDC, FFDRC HW3,HW6	12.04 -	D 2676 LF 04		4300.90.101	430 10	- GBox: ZF Ecosplit-3
41.440 FFD/M HW6	12.04 -	D 2676 LF 01		4386.20.00	MFZ430	
41.440 FFDC-TM, FFDRC-TM, FFD-TM HW3	09.07 -	D 2676 LF 02		4386.30.00	430WGTZ	
41.440 FFDK, FFDRK HW3,HW6	12.04 -	D 2676 LF 03		8916.40.00	KZIZ - 5	
41.460 FFDC, FFDRC H38,H46	09.03 -	D 2676 LF 05		4300.90.102	430 10	- GBox: ZF Ecosplit-3
41.460 FFDC-TM, FFDRC-TM, FFD-TM H38	12.04 -	D 2676 LF 13		4386.20.00	MFZ430	
41.460 FFDK, FFDRK H38,H46	09.03 -	D 2876 LF 04		4386.30.00	430WGTZ	
41.480 FFD, FFDC, FFDRC H36,H46	06.05 -	D 2876 LF 07		8916.40.00	KZIZ - 5	
41.480 FFD, FFDC, FFDRC HW3, H39, HW6	02.06 -	D 2876 LF 12		4300.90.103	430 10	- GBox: AS-Tronic
41.480 FFDK, FFDRK H76	07.06 -	D 2876 LF 13		4386.20.00	MFZ430	
41.480 FFDARC H76	07.06 -	D 2876 LF 25		4386.30.00	430WGTZ	
41.480 FFDC-TM, FFDRC-TM HW3	09.07 -			8919.40.00	KZISZ - 5	
41.480 FFDC-TM, FFDRC-TM, FFD-TM HW3	12.04 -			4300.90.104	430 10	- GBox: AS-Tronic
41.480 FFDC-TM, FFDRC-TM, FFD-TM H39,HW6	02.06 -			4386.20.00	MFZ430	
41.480 FFDK, FFDRK H38,H46	06.05 -			4386.30.00	430WGTZ	
41.480 FFDK, FFDRK HW3, H39, HW6	02.06 -			8939.40.00	KZISZ - 5	
41.480 FVDS, FVDLS H94	07.06 -			4300.90.105	430 10	- GBox: AS-Tronic
41.530 FFDK, FFDRK H76	07.06 -			4386.20.00	MFZ430	
41.530 FFDK, FFDRK H73	07.06 -			4386.30.00	430WGTZ	
41.530 FFDC 38	12.04 -			8939.40.00	KZISZ - 5	
41.530 FFDC-TM, FFDRC-TM, FFD-TM H38	12.04 -			43461.30.00	430 10	- GBox: ZF 16S-151/181 - For PTO
41.530 FFDK, FFDRK H38	12.04 -			8950.40.00	KZIZ-6	- GBox: ZF 16S-151/181 - For PTO
41.540 FVDS, FVDLS H94	11.06 -					
26.280 FNLC, FNLLC, FNLLW H16, H19	11.02 -	D 0836 LF 41		3950.90.02	395 10	- GBox: EATON FS/FSO-8309
				3956.20.00	MFZ395	
				3951.30.00	395WGTZ	
				8535.40.00	KZIZ - 4,5	
				3950.90.15	395 10	- GBox: 12AS-1210TO, AS-Tronic
				3956.20.00	MFZ395	
				3951.30.00	395WGTZ	
				8939.40.00	KZISZ - 5	
				3950.90.25	395 10	- GBox: ZF-9S-1310TO
				3972.20.00	MF395	
				3951.30.00	395WGTZ	
				8514.40.00	KZI - 4,5	
				8919.40.00	KZISZ - 5	- GBox: 12AS-1210TO, AS-Tronic
				3951.30.00	395 10	- GBox: ZF-9S-1310TO; EATON FS/FSO-8309;
					395WGTZ	

Vehicle list

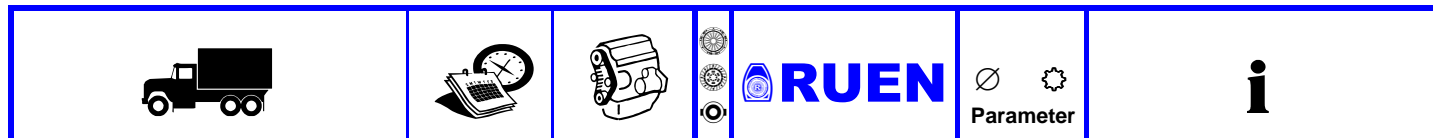

MAN

TGA		03.00 -			
26.360 FNLC, FNLLC, FNLLRC, FNLLRW, FNLLW, FNLRC, FVLC H17, H20, H23	09.00 -	D 2866 LF27	4300.90.20	430 10	- GBox: ZF Ecosplit-3
26.410 FDLRS, FDLS, FDRS, FDS H63, H25, H29	06.01 -	D 2866 LF28	4319.20.00	MFZ430	
26.410 FD-TM, FDR-TM H25	01.01 -	D 2866 LF32	4346.30.00	430WGTZ	
26.410 FNLC, FNLLC, FNLLRC, FNLLRW, FNLLW, FNLRC, FVLC H17, H20, H23	04.00 -	D 2866 LF37	8916.40.00	KZIZ - 5	
26.410 FPLS, FPLRS, FVLS, FNLS, FNLLS, FNLRS H17, H20, H23	12.00 -		4028.10.00	400	- GBox: ZF Ecosplit-3
26.410 FVL-KO H23	12.00 -		4036.30.00	MFZ2/400X	- Vehicles with double disc clutch
			8941.40.00	400 10	- GBox: ZF Ecosplit-3
			4300.90.13	400 WGTZ	- Vehicles with double disc clutch
			4319.20.00	KZISZ-5	- GBox: ZF Ecosplit-3
			4346.30.00		- Vehicles with double disc clutch
			8919.40.00		
			4300.90.56	430 10	- GBox: ZF-AS-Tronic
			4319.20.00	MFZ430	
			4346.30.00	430WGTZ	
			8939.40.00	KZISZ - 5	
			43461.30.00	430 10	- GBox: ZF 16S-151/181
			8950.40.00	430WGTZ	- For PTO
			8919.40.00	KZIZ-6	- GBox: ZF 16S-151/181
			4319.20.00	KZISZ - 5	- For PTO
			4305.30.00	KZISZ - 5	- GBox: ZF-AS-Tronic
			4319.20.00	430	- GBox: ZF Ecosplit-3, AS-Tronic
			4305.30.00	MFZ430	
				430W2GTZ	- GBox: ZF Ecosplit-3, AS-Tronic

Vehicle list









MAN

TGA 03.00 -



















26.430, 26.440, FNLC, FNLLC, FNLLW, FNLC, FNLLRC, FVLC H18, H24, H21, HV1	05.04 -	D 2066 LF 01 D 2066 LF 11 D 2066 LF 23 D 2066 LF 25	4300.90.101 4386.20.00 4386.30.00 8916.40.00	430 10 MFZ430 430WGTZ KZIZ - 5	- GBox: ZF-Ecosplit-3, Eaton
26.460 FPLS, FPLRS, FVLS, FVLRS, FNLS, FNLLS, FNLRS H17, H20, H23	12.00 -	D 2066 LF 31 D 2066 LF 36	4300.90.102 4386.20.00 4386.30.00 8916.40.00	430 10 MFZ430 430WGTZ KZIZ - 5	- GBox: ZF-Ecosplit-3, Eaton
26.480 FNLC, FNLLC, FNLLRC, FNLLW, FNLC, FVLC H17, H20, H23	09.02 -	D 2876 LF 04 D 2876 LF 05	4028.10.00	400 MFZ2/400X	- GBox: ZF-Ecosplit-3 - Vehicles with double disc clutch
26.480 FNLS, FNLLS, FNLRS, FPLS, FVLS, FVLRS H17, H20, H23	09.02 -	D 2876 LF 07 D 2876 LF 12	4036.30.00	400 10 400 WGTZ	- GBox: ZF Ecosplit-3 - Vehicles with double disc clutch
26.510 FNLC, FNLLC, FNLLRC, FNLLRW, FNLLW, FNLRC, FVLC H17, H20, H23	12.00 -	D 2876 LF 13	8941.40.00	KZISZ-5	- GBox: ZF-Ecosplit-3 - Vehicles with double disc clutch
26.510 FNLS, FNLLS, FNLRS, FPLS, FVLS, FVLRS H17, H20, H23	12.00 -		4300.90.103 4386.20.00 4386.30.00 8919.40.00	430 10 MFZ430 430WGTZ KZISZ - 5	- GBox: AS-Tronic
26.530 FNLC, FNLLC, FNLLRC, FNLLRW, FNLLW, FNLRC, FVLC, FVLRC H17, H20, H23	09.02 -		4300.90.104 4386.20.00 4386.30.00 8939.40.00	430 10 MFZ430 430WGTZ KZISZ - 5	- GBox: AS-Tronic
26.530 FNLS, FNLLS, FNLRS, FPLS, FVLS, FVLRS H17, H20, H23	09.02 -		4300.90.105 4386.20.00 4386.30.00 8939.40.00	430 10 MFZ430 430WGTZ KZISZ - 5	- GBox: AS-Tronic
33.480 FDC-TM, FDCR-TM, FD-TM H25	09.02 -		43461.30.00	430 10 430WGTZ	- GBox: ZF 16S-151/181 - For PTO
33.510 FDC, FDLC, FDCR, FDLRC H25, H29	09.02 -		8950.40.00	KZIZ-6	- GBox: ZF 16S-151/181 - For PTO
33.510 FDLRS, FDLS, FDRS, FDS H25, H29	09.02 -		4386.20.00	430 MFZ430	- GBox: ZF Ecosplit-3, Eaton, AS-Tronic
33.530 FDC, FDLC, FDCR, FDLRC H25, H29	09.02 -		4386.30.00	430 10 430WGTZ	- GBox: ZF Ecosplit-3, Eaton, AS-Tronic
33.530 FDK, FDLK H25, H29	07.03 -				
33.530 FDLRS, FDLS, FDRS, FDS H25, H29	07.03 -				
33.410 FDAC, FDALC, FDARC H55, H54, H72	09.02 -	D 2866 LF27 D 2866 LF28	4300.90.20 4319.20.00 4346.30.00 8916.40.00	430 10 MFZ430 430WGTZ KZIZ - 5	
33.410 FDAK, FDALK H55, H54, H72	09.02 -	D 2866 LF32			
33.410 FDALS, FDARS, FDAS H55, H54, H72	09.02 -	D 2866 LF37			
41.360 FFDC, FFDC/M, FFDC/M-WW, FFDCR H38, HW3, H46	01.03 -		4300.90.13 4319.20.00 4346.30.00 8919.40.00	430 10 MFZ430 430WGTZ KZISZ - 5	- GBox: AS-Tronic
			4300.90.56 4319.20.00 4346.30.00 8939.40.00	430 10 MFZ430 430WGTZ KZISZ - 5	- GBox: AS-Tronic















Vehicle list

					
---	---	---	--	---	---







MAN

TGA 03.00 -

35.400 FFNHLC HH4	11.06 -	D 2066 LF 37	 4300.90.52	430 10	- GBox: ZF Ecosplit-3
			 4319.20.00	MFZ430	
			 4346.30.00	430WGTZ	
			 8916.40.00	KZIZ - 5	
			 4300.90.56	430 10	- GBox: ZF AS-Tronic
			 4319.20.00	MFZ430	
			 4346.30.00	430WGTZ	
			 8939.40.00	KZISZ - 5	
			 4300.90.13	430 10	- GBox: ZF AS-Tronic
			 4319.20.00	MFZ430	
 4346.30.00	430WGTZ				
 8919.40.00	KZISZ - 5				
 43461.30.00	430 10	- GBox: ZF Ecosplit-3; ZF AS-Tronic			
	430WGTZ	- For PTO			
 8950.40.00	KZIZ-6	- GBox: ZF Ecosplit-3			
		- For PTO			
 4028.10.00	400	- GBox: ZF Ecosplit-3			
	MFZ2/400X	- Vehicles with double disc clutch			
 4036.30.00	400 10	- GBox: ZF Ecosplit-3			
	400 WGTZ	- Vehicles with double disc clutch			
 8941.40.00	KZISZ-5	- GBox: ZF Ecosplit-3			
		- Vehicles with double disc clutch			
 4319.20.00	430	- GBox: ZF Ecosplit-3; ZF AS-Tronic			
	MFZ430				
 4306.30.00	430 10	- GBox: ZF Ecosplit-3; ZF AS-Tronic			
	430WGTZ				

33.440 FDLS, FDRS, FDS H66, HW8, HW2, HW9	06.05 -	D 2676 LF 04	 4300.90.102	430 10	- GBox: : ZF Ecosplit 3
			 4386.20.00	MFZ430	
			 4386.30.00	430WGTZ	
			 8916.40.00	KZIZ - 5	
			 4300.90.105	430 10	- GBox: ZF AS-Tronic
			 4386.20.00	MFZ430	
			 4386.30.00	430WGTZ	
			 8939.40.00	KZISZ - 5	
			 8919.40.00	KZISZ - 5	- GBox: ZF AS-Tronic
 43461.30.00	430 10	- GBox: ZF Ecosplit 3			
	430WGTZ	- For PTO			
 8950.40.00	KZIZ-6	- GBox: ZF Ecosplit 3			
		- For PTO			
 4028.10.00	400	- GBox: ZF Ecosplit 3			
	MFZ2/400X	- Vehicles with double disc clutch			
 4036.30.00	400 10	- GBox: ZF Ecosplit-3			
	400 WGTZ	- Vehicles with double disc clutch			
 8941.40.00	KZISZ-5	- GBox: ZF Ecosplit 3			
		- Vehicles with double disc clutch			
 4386.30.00	430 10	- GBox: ZF AS-Tronic, ZF Ecosplit 3			
	430WGTZ				

TGL 04.05 -

7.150, 8.150 FC, FRC, FLC, FLRC N01, N11, N13, N03	04.05 -	D 0834 LFL 40 D 0834 LFL 50 D 0834 LFL 53 D 0834 LFL 63	 3620.90.19	362 10	- Engine code: D0834LFL63/66
			 3601.20.00	MF362	- GBox: ZF 6S-850
			 3607.30.00	362WGTZ	
			 8632.47.00	Fill Medium: M	
			 3620.90.09	362 10	- Engine code: D0834LFL63/66
			 3601.20.00	MF362	- GBox: ZF 6S-850, ZF 6AS-850
			 3607.30.00	362WGTZ	

Vehicle list

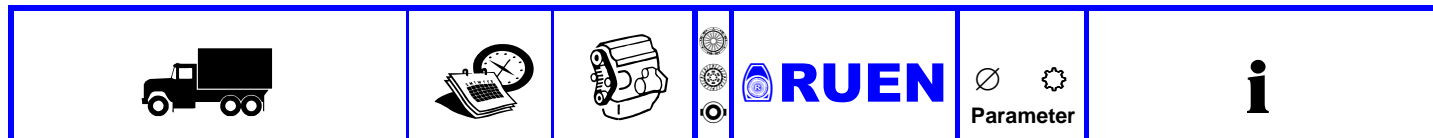

MAN

TGL		04.05 -				
7.180, 8.180 FC, FLC, FRC, FLRC N01, N11, N13, N03 8.180 FC, FRC, FLC, FLRC N02, N60, N12, N13, N03 8.180 FK, FK-L, FLK, FLK-L, FLRK, FLRK-L, FRK, FRK-L N02, N12, N13, N03 10.180 FC, FRC, FLC, FLRC N04, N05, N15, N61, N14 10.180 FK, FLK, FLRK, FRK N04, N05, N15, N14 12.180 FC, FRC, FLC, FLRC N04, N05, N15, N61, N14 12.180 FK, FLK, FLRK, FRK N04, N05, N15, N14 12.210 FC, FRC, FLC, FLRC N04, N05, N15, N61, N14	04.05 -	D 0834 LFL 41 D 0834 LFL 42	3620.90.19 3601.20.00 3607.30.00 8632.47.00	362 10 MF362 362WGTZ Fill Medium: M	- Engine code: D0834LFL64/67 - GBox: ZF 6S-850	
	04.05 -	D 0834 LFL 51 D 0834 LFL 52	3620.90.09 3601.20.00 3607.30.00	362 10 MF362 362WGTZ	- Engine code: D0834LFL64/67 - GBox: ZF 6S-850, ZF 6AS-850	
	04.05 -	D 0834 LFL 54 D 0834 LFL 55 D 0834 LFL 64				
	8.210 FC, FRC, FLC, FLRC N02, N60, N12, N13, N03 8.210 FK, FK-L, FLK, FLK-L, FLRK, FLRK-L, FRK, FRK-L N02, N12, N13, N03 10.210 FC, FRC, FLC, FLRC N04, N05, N15, N14 12.210 FK, FLK, FLRK, FRK N04, N05, N15, N14	04.05 -	D 0834 LFL 42 D 0834 LFL 52	3620.90.19 3601.20.00 3607.30.00 8632.47.00	362 10 MF362 362WGTZ Fill Medium: M	- Engine code: D0834LFL55 - GBox: ZF 6S-850
		04.05 -	D 0834 LFL 55	3620.90.09 3601.20.00 3607.30.00	362 10 MF362 362WGTZ	- Engine code: D0834LFL55 - GBox: ZF 6S-850, ZF 6AS-850
		04.05 -				
		04.05 -				
	8.240 FC, FRC, FLC, FLRC N02, N60, N12 8.240 FK, FK-L, FLK, FLK-L, FLRK, FLRK-L, FRK, FRK-L N02, N12	04.05 -	D 0836 LFL 40 D 0836 LFL 50	3950.90.02 3956.20.00 3951.30.00 8535.40.00	395 10 MFZ395 395WGTZ KZIZ - 4,5	- GBox: Eaton FS/FSO-8309
		04.05 -	D 0836 LFL 53	3950.90.15 3956.20.00 3951.30.00 8939.40.00	395 10 MFZ395 395WGTZ KZISZ - 5	- GBox: 12 AS 1210 TO, AS-Tronic - Use release fork with rollers
			3950.90.25 3972.20.00 3951.30.00 8514.40.00	395 10 MF395 395WGTZ KZI - 4,5	- GBox: ZF-9S-1310TO	
			8919.40.00	KZISZ - 5	- GBox: 12 AS 1210 TO, AS-Tronic - Use release fork with cam	
10.210 FK, FLK, FLRK, FRK N04, N05, N15, N14	04.05 -	D 0834 LFL 42 D 0834 LFL 52 D 0834 LFL 55	3620.90.19 3601.20.00 3607.30.00 8632.47.00	362 10 MF362 362WGTZ Fill Medium: M	- Engine code: D0834LFL55/65 - GBox: ZF 6S-850	
			3620.90.09 3601.20.00 3607.30.00	362 10 MF362 362WGTZ	- Engine code: D0834LFL55/65 - GBox: ZF 6S-850, ZF 6AS-850	

Vehicle list

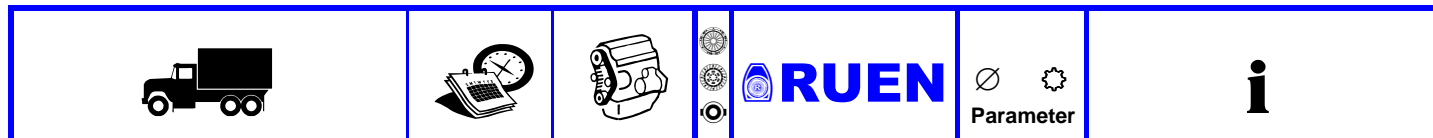

MAN

TGL 04.05 -

10.240 FC, FRC, FLC, FLRC N04, N05, N15, N14 10.240 FK, FLK, FLRK, FRK N04, N05, N15, N14 12.240 FC, FRC, FLC, FLRC N04, N05, N15, N14 12.240 FK, FLK, FLRK, FRK N04, N05, N15, N14	04.05 -	D 0836 LFL 40	3950.90.15	395 10	- Engine code: D0836LFL53 - GBox: ZF 12AS-1210 TO
	04.05 -	D 0836 LFL 50	3956.20.00	MFZ395	- Use release fork with rollers
	04.05 -	D 0836 LFL 53	3951.30.00	395WGTZ	
	04.05 -		8939.40.00	KZISZ - 5	
	04.05 -		3950.90.25	395 10	- Engine code: D0836LFL53 - GBox: ZF 9S-1310 TO, HD
	04.05 -		3972.20.00 3951.30.00 8514.40.00	MF395 395WGTZ KZI - 4,5	
7.220 FC, FLC, FRC, FLRC N01, N11, N13, N03 7.250 FC, FLC, FRC, FLRC N01, N11, N13, N03	04.05 -	D 0834 LFL 62	3620.90.19	362 10	- Engine code: D0834LFL63/65 - GBox: ZF 6S-850
	04.05 -	D 0834 LFL 65	3601.20.00	MF362	
	04.05 -	D 0836 LFL 60	3607.30.00	362WGTZ	
	04.05 -	D 0836 LFL 63	8632.47.00	Fill Medium: M	
	04.05 -		3620.90.09	362 10	- Engine code: D0834LFL63/65 - GBox: ZF 6S-850, ZF 6AS-850
	04.05 -		3601.20.00 3607.30.00	MF362 362WGTZ	
8.150 FK, FK-L, FLK, FLK-L, FLRK, FLRK-L, FRK, FRK-L N01, N11, N13, N03	10.06 -	D 0834 LFL 40	3620.90.19	362 10	- Engine code: D0834LFL63/66 - GBox: ZF 6S-850
	10.06 -	D 0834 LFL 50	3601.20.00	MF362	
	10.06 -	D 0834 LFL 53	3607.30.00	362WGTZ	
	10.06 -	D 0834 LFL 63	8632.47.00	Fill Medium: M	
8.250 FC, FLC, FLRC, FRC N02, N60, N12 8.250 FK, FK-L, FLK, FLK-L, FLRK, FLRK-L, FRK, FRK-L N02, N12 10.250 FC, FLC, FRC, FLRC N04, N05, N15, N14 10.250 FK, FLK, FLRK, FRK N04, N05, N15, N14 12.250 FC, FLC, FRC, FLRC N04, N05, N15, N14 12.250 FK, FLK, FLRK, FRK N04, N05, N15, N14	04.05 -	D 0836 LFL 60	3950.90.15	395 10	- Engine code: D0836LFL63/66 - GBox: ZF 12AS-1210 TO
	04.05 -	D 0836 LFL 63	3956.20.00	MFZ395	- Use release fork with rollers
	04.05 -	D 0836 LFL 66	3951.30.00	395WGTZ	
	04.05 -	D 0836 LFL 75	8939.40.00	KZISZ - 5	
	04.05 -		3950.90.25	395 10	- Engine code: D0836LFL63/66 - GBox: ZF 9S-1310 TO, HD
	04.05 -		3972.20.00 3951.30.00 8514.40.00	MF395 395WGTZ KZI - 4,5	
	04.05 -		3956.20.00	395	- Engine code: D0836LFL63/66 - GBox: 12AS-1010/1210, ZF 12AS-1210 TO
	04.05 -		3951.30.00	395 10	- Engine code: D0836LFL63/66 - GBox: 12AS-1010/1210, ZF 12AS-1210 TO, ZF 9S-1310 TO
	04.05 -		3951.30.00	395WGTZ	
	04.05 -		8919.40.00	KZISZ - 5	- Engine code: D0836LFL63/66 - GBox: ZF 12AS-1210 TO - Use release fork with cam
12.250 FK, FLK, FLRK, FRK N04, N05, N15, N14	04.05 -		3957.30.00	395 10	- Engine code: D0836LFL63/66 - GBox: ZF 12AS-1210 TO
	04.05 -			395WGTZ	

Vehicle list



MAN

TGL 04.05 -

8.220 FC, FLC, FRC, FLRC N02, N60, N12, N13, N03	04.05 -	D 0834 LFL 62	3620.90.19	362 10	- Engine code: D0834LFL65/68 - GBox: ZF 6S-850
8.220 FK, FK-L, FLK, FLK-L, FLRK, FLRK-L, FRK, FRK-L N02, N12, N13, N03	04.05 -	D 0834 LFL 65	3601.20.00	MF362	
		D 0834 LFL 68	3607.30.00	362WGTZ	
		D 0834 LFL 76	8632.47.00	Fill Medium: M	
10.220 FC, FLC, FRC, FLRC N04, N05, N15, N14	04.05 -		3620.90.09	362 10	- Engine code: D0834LFL65/68 - GBox: ZF 6S-850, ZF 6AS-850
10.220 FK, FLK, FLRK, FRK N04, N05, N15, N14	04.05 -		3601.20.00	MF362	
			3607.30.00	362WGTZ	
12.220 FC, FRC, FLC, FLRC N04, N05, N15, N14	04.05 -		3601.20.00	362	- Engine code: D0834LFL65/68 - GBox: ZF S5-42/ 6S-850, ZF 6AS-850
12.220 FK, FLK, FLRK, FRK N04, N05, N15, N14	04.05 -			MF362	

TGM 10.05 -

13.280 FAEC, FAERC, FAL, FALC, FALRC N37, N34, N36	04.06 -	D 0836 LFL 41	3950.90.02	395 10	- Engine code: Eaton FS/FSO-8309
13.280 FALK, FALRK, FALK-L, FALRK-L N37, N34, N36	04.06 -	D 0836 LFL 51	3956.20.00	MFZ395	
		D 0836 LFL 54	3951.30.00	395WGTZ	
18.280 FAC, FARC N38	10.05 -		8535.40.00	KZIZ - 4,5	
18.280 FC, FRC, FLC, FLRC, FLLC, FLLRC N65, N28, N08, N18, N62	10.05 -		3950.90.15	395 10	- Engine code: AS-Tronic 12AS-1010 - Use release fork with rollers
18.280 FK, FK-L, FLK, FLK-L, FLRK, FLRK-L, FRK, FRK-L N08, N18, N62	10.05 -		3956.20.00	MFZ395	
			3951.30.00	395WGTZ	
			8939.40.00	KZISZ - 5	
			8919.40.00	KZISZ - 5	- GBox: AS-Tronic 12AS-1010 - Use release fork with cam
			3950.90.25	395 10	- Engine code: ZF-9S-1310TO
			3972.20.00	MF395	
			3951.30.00	395WGTZ	
			8514.40.00	KZI - 4,5	
			3620.90.30	362 10	
			3610.20.00	MFZ362	
			3610.30.00	362GTZ	
			8633.47.00	HHISZ-3	
			4301.20.00	430	- GBox: ZF S6-85/1600/1200
			4356.30.00	430 10	- GBox: ZF S6-85/1600/1200
			8916.40.00	430WGTZ	
			8916.40.00	KZIZ - 5	- GBox: ZF S6-85/1600/1200
			3620.90.10	362 10	
			3610.20.00	MFZ362	
			3610.30.00	362GTZ	
12.240 FLC, FLLC N16, N26	10.05 -	D 0836 LFL 64	3950.90.02	395 10	- GBox: Eaton FS/FSO-8309
12.280 FC, FLC, FLLC N16, N26	10.05 -	D 0836 LFL 40	3956.20.00	MFZ395	
13.240 FALK, FALRK, FALK-L, FALRK-L N37, N34, N36	04.06 -	D 0836 LFL 41	3951.30.00	395WGTZ	
15.240 FLK, FLRK N18	10.05 -	D 0836 LFL 44	8535.40.00	KZIZ - 4,5	
15.280 FC, FLC, FLLC, FLRC, FLLRC N16, N08, N18, N26	10.05 -	D 0836 LFL 50	3950.90.15	395 10	- GBox: AS-Tronic 12AS-1010 - Use release fork with rollers
15.290 FC, FLC, FLRC, FLLC, FLLRC N16, N08, N18, N26	10.05 -	D 0836 LFL 51	3956.20.00	MFZ395	
		D 0836 LFL 52	3951.30.00	395WGTZ	
		D 0836 LFL 53	8939.40.00	KZISZ - 5	
15.330 FC, FLC, FRC, FLRC N08, N18	10.05 -	D 0836 LFL 54	8919.40.00	KZISZ - 5	- GBox: AS-Tronic 12AS-1010 - Use release fork with cam
22.240 FNLLC N26	10.05 -	D 0836 LFL 55			
22.280 FNLC, FNLLC, FNLLRC, FNLR N26	10.05 -	D 0836 LFL 67	3950.90.25	395 10	- GBox: ZF-9S-1310TO
26.280 FDK-HK, FDRK-HK N48	04.06 -		3972.20.00	MF395	
26.280 FD-TM, FDR-TM N48	04.06 -		3951.30.00	395WGTZ	
26.330 FD, FDR 48	10.05 -		8514.40.00	KZI - 4,5	
26.330 FDK-HK, FDRK-HK N48	04.06 -				
26.330 FD-TM, FDR-TM N48	04.06 -				

Vehicle list



MAN

























TGM 10.05 -

12.250 FLC, FLLC N16,N26	10.05 -	D 0836	3950.90.02	395 10	- GBox: Eaton FS/F50-8309
12.290 FLC, FLLC N16,N26	10.05 -	LFL 64	3956.20.00	MFZ395	
13.250 FAEC, FAERC, FALC, FAL, FALRC, FALR N37, N3N36	10.05 -	D 0834 LFL 64	3951.30.00	395WGTZ	
13.250 FALK, FALRK, FALK-L, FALRK-L N37, N34, N36	10.05 -	D 0834 LFL 65	8535.40.00	KZIZ - 4,5	
13.250 FALK, FALRK, FALK-L, FALRK-L N37, N34, N36	10.05 -	D 0834 LFL 66	3950.90.15	395 10	- GBox: AS-Tronic 12AS-1010
13.290 FAEC, FAERC, FAL, FALR, FALC, FALRC N37, N34, N36	10.05 -	D 0836 LFL 54	3956.20.00	MFZ395	- Use release fork with rollers
13.290 FALK, FALRK, FALK-L, FALRK-L N37, N34, N36	10.05 -	D 0836 LFL 55	3951.30.00	395WGTZ	
15.250 FC, FLC, FLRC, FLLC, FLLRC N16, N08, N18, N26	10.05 -	D 0836 LFL 63	8939.40.00	KZISZ - 5	
15.250 FK, FK-L, FLK, FLK-L, FLRK N08, N18	10.05 -	D 0836 LFL 65	8919.40.00	KZISZ - 5	- GBox: AS-Tronic 12AS-1010
15.250 FK, FK-L, FLK, FLK-L, FLRK N08, N18	10.05 -	D 0836 LFL 66			- Use release fork with cam
15.340 FC, FLC, FLRC N08, N18	10.05 -	D 0836 LFL 67			
15.340 FK, FK-L, FLK, FLK-L, FLRK N08, N18	10.05 -	D 0836 LFL 68			
18.250 C/L/LX N28					
18.250 FAC, FARC N38	10.05 -				
18.250 FAK, FARK, FAK-L, FARK-L N38	10.05 -				
18.250 FC, FLC, FLLC, FRC, FLRC, FLLRC N28, N08, N18	10.05 -				
18.250 FK, FK-L, FLK, FLK-L, FLRK, FLRK-L, FRK, FRK-L N08,N18	10.05 -				
18.290 C/L/LX N28					
18.290 FAC, FARC N38	10.05 -				
18.290 FAK, FARK, FAK-L, FARK-L N38	10.05 -				
18.290 FC, FLC, FRC, FLRC, FLLC, FLLRC N28, N08, N18	10.05 -				
18.290 FK, FK-L, FLK, FLK-L, FLRK, FLRK-L, FRK, FRK-L N08,N18	10.05 -				
18.340 C/L/LX N28					
18.340 FAC, FARC N38	10.05 -				
18.340 FAK, FARK, FAK-L, FARK-L N38	10.05 -				
18.340 FC, FLC, FLRC, FLLC, FLLRC, FRC N28, N08, N18	10.05 -				
18.340 FK, FK-L, FLK, FLK-L, FLRK, FLRK-L, FRK, FRK-L N08, N18	10.05 -				
22.250 FNLLC N26	10.05 -				
22.290 FNLC, 22.290 FNLLC N26	10.05 -				
26.280 FD N48	10.05 -				
26.280 FNLC, FNLLC, FNLRC, FNLLRC N44,N46	10.05 -				
26.290 FD, FDR N48	10.05 -				
26.290 FD-TM, FDR-TM N48	07.08 -				
26.290 FDK-HK, FDRK-HK N48	10.05 -				
26.290 FNLC, FNLLC, FNLRC, FNLLRC, FVL N44,N46	10.05 -				
26.330 FNLC, FNLLC, FNLRC, FNLLRC, FVL N44,N46	10.05 -				
26.340 FD, FDR N48	10.05 -				
26.340 FDK-HK, FDRK-HK N48	10.05 -				
26.340 FNLC, FNLLC, FNLRC, FNLLRC N44,N46	10.05 -				
26.340 FD-TM, FDR-TM N48	07.08 -				

Vehicle list

					
---	---	---	--	---	---

MAN

TGM		10.05 -				
13.240 FAL, FALC, FALRC, FAEC, FAERC, FALR N37, 4,N3 N36	04.06 -	D 0836 LFL 40	 3950.90.02	395 10	- GBox: Eaton FS/FSO-8309	
15.240 FC, FLC, FLLC, FLRC, FLLRC N16, N08, N63, N18, N26	10.05 -	D 0836 LFL 41	 3956.20.00	MFZ395		
15.280 FLK, FLRK N18	10.05 -	D 0836 LFL 44	 3951.30.00	395WGTZ		
15.330 FLK, FLRK N18	10.05 -	D 0836 LFL 50	 8535.40.00	KZIZ - 4,5		
18.240 FAC, FARC N38,N64	10.05 -	D 0836 LFL 52	 3950.90.15	395 10	- GBox: AS-Tronic 12AS-1010	
18.240 FAK, FARK, FAK-L, FARK-L N38	10.05 -	D 0836 LFL 53	 3956.20.00	MFZ395	- Use release fork with rollers	
18.240 FC, FRC, FLC, FLRC, FLLC, FLLRC N28, N08, N18, N62	10.05 -	D 0836 LFL 54	 3951.30.00	395WGTZ		
18.240 FK, FK-L, FLK, FLK-L, FLRK, FLRK-L, FRK, FRK-L N08, N18, N62	05.06 -	D 0836 LFL 55	 8939.40.00	KZISZ - 5		
18.280 FAK, FARK, FAK-L, FARK-L N38	10.05 -		 8919.40.00	KZISZ - 5		
18.330 FAC, FARC N38	10.05 -		 3950.90.25	395 10	- GBox: ZF-9S-1310TO	
18.330 FAK, FARK, FAK-L, FARK-L N38	10.05 -		 3972.20.00	MF395		
18.330 FC, FRC, FLC, FLRC, FLLC, FLLRC N28, N08, N18	10.05 -		 3951.30.00	395WGTZ		
18.330 FK, FK-L, FLK, FLK-L, FLRK, FLRK-L, FRK, FRK-L N08, N18	10.05 -		 8514.40.00	KZI - 4,5		
	10.05 -		 3620.90.30	362 10		
	10.05 -		 3610.20.00	MFZ362		
	10.05 -		 3610.30.00	362GTZ		
	10.05 -		 8633.47.00	HHISZ-3		
	10.05 -		 4301.20.00	430	- GBox: ZF S6-85/1600/1200	
	10.05 -		 4356.30.00	MFZ430		
	10.05 -		 430 10	430WGTZ	- GBox: ZF S6-85/1600/1200	
	10.05 -		 8916.40.00	KZIZ - 5	- GBox: ZF S6-85/1600/1200	
	10.05 -		 3620.90.10	362 10		
	10.05 -		 3610.20.00	MFZ362		
	10.05 -		 3610.30.00	362GTZ		
TGS						
TGS Euro 6	01.14 -		 8939.40.00	KZISZ - 5	- Engine code: D3876 LF	

Vehicle list



MAN

TGS

18.320 FAC, FHLC 22S, 52S	10.07 -	D 2066 LF 01	4300.90.52	430 10	- GBox: ZF Ecosplit-3
18.320 FAK, FAK-L, FALK, FALK-L, FHLK, FHLK/M 22S, 80S, 52S	10.07 -	D 2066 LF 02	4319.20.00	MFZ430	
18.320 FAS, FHLS, FHLS/M, FALS 22S 80S, 52S	10.07 -	D 2066 LF 03	4346.30.00	430WGTZ	
18.320 FC, FLC, FLRC, FLLC, FLLRC, FLLW, FLLW/N 06S, 10S, 03S, 15S	10.07 -	D 2066 LF 25	8916.40.00	KZIZ - 5	
18.320 FK, FK-L, FLK, FLK/M 06S, 03S	10.07 -	D 2066 LF 26	4300.90.56	430 10	- GBox: ZF AS-Tronic
18.320 FLS, FLS/M, FLS-TS, FLRS, FLRS/M, FLLS, FLLS/N, FLLRS 06S, 10S, 13S, 08S	10.07 -	D 2066 LF 27	4319.20.00	MFZ430	- Use release fork with rollers
18.350 FAC 52W	10.07 -	D 2066 LF 28	4346.30.00	430WGTZ	
18.350 FAK 52W	10.07 -	D 2066 LF 36	8939.40.00	KZISZ - 5	
18.350 FAS 52W	10.07 -	D 2066 LF 37	4300.90.13	430 10	- GBox: ZF AS-Tronic
18.360 FAC, FHLC 22S, 52W, 52S	10.07 -	D 2066 LF 38	4319.20.00	MFZ430	- Use release fork with cam
18.360 FAK, FAK-L, FALK, FALK-L, FHLK, FHLK/M 22S, 52W, 80S, 52S	10.07 -	D 2066 LF 39	4346.30.00	430WGTZ	
18.360 FAS, FALS, FHLS, FHLS/M 22S, 52W, 80S, 52S	10.07 -	D 2066 LF 40	8919.40.00	KZISZ - 5	
18.360 FC, FLC, FLRC, FLLC, FLLRC, FLLW, FLLW/N 06S, 10S, 03S, 15S	10.07 -	D 2066 LF 41	43461.30.00	430 10	- GBox: ZF Ecosplit-3
18.360 FK, FK-L, FLK, FLK/M 06S, 03S	10.07 -	D 2066 LF 42	8950.40.00	430WGTZ	- For PTO
18.360 FLS, FLS/M, FLS-TS, FLRS, FLRS/M, FLLS, FLLS/N, FLLRS 06S, 10S, 13S, 08S	10.07 -	D 2066 LF 43	4028.10.00	KZIZ-6	- GBox: ZF Ecosplit-3
18.390 FAC, FHLC 52W	06.08 -	D 2066 LF 48	4036.30.00	400	- GBox: ZF Ecosplit-3
18.390 FAK 52W	06.08 -	D 2066 LF 49	8941.40.00	MFZ2/400X	- Vehicles with double disc clutch
18.390 FAS 52W	06.08 -	D 2066 LF 51			- This part number includes one clutch disc
18.400 FAC, FHLC 22S, 52W, 52S	10.07 -	D 2066 LF 52		400 10	- GBox: ZF Ecosplit-3
18.400 FAK, FAK-L, FALK, FALK-L, FHLK, FHLK/M 22S, 80S, 52S	10.07 -	D 2066 LF 53		400 WGTZ	- Vehicles with double disc clutch
18.400 FAS, FALS, FHLS, FHLS/M 22S, 52W, 80S, 52S	10.07 -	D 2066 LF 61			
18.400 FC, FLC, FLRC, FLLC, FLLRC, FLLW, FLLW/N 06S, 10S, 03S, 15S	10.07 -	D 2066 LF 63			
18.400 FK, FK-L, FLK, FLK/M 06S, 03S	10.07 -	D 2066 LF 64			
18.400 FLS, FLS/M, FLS-TS, FLRS, FLRS/M, FLLS, FLLS/N, FLLRS	10.07 -	D 2066 LF 67			
18.430 FAC 52W	10.07 -	D 2066 LF 68			
18.430 FAK 52W	10.07 -				
18.430 FAS 52W	10.07 -				
24.320 FNLLW/N 45S	10.07 -				
24.320 FPLS, FPLRS 24S	10.07 -				
24.360 FNLLW/N 45S	10.07 -				
24.360 FPLS, FPLRS 24S	10.07 -				
24.400 FNLLW/N 45S	10.07 -				
24.400 FPLS, FPLRS 24S	10.07 -				

Vehicle list



MAN

TGS

26.320 FDAC, FDALC, FDHLC, FDHLC/M 82S, 70S, 56S	07.08 -	D 2066 LF 07	4300.90.52	430 10	- GBox: ZF Ecosplit-3
26.320 FDAK, FDALK, FDHK, FDHLK 82S, 70S, 47S, 56S	07.08 -	D 2066 LF 27	4319.20.00	MFZ430	
26.320 FDAS, FDALS, FDHS, FDHLS, FDHLS/M 82S, 70S, 47S, 56S	07.08 -	D 2066 LF 28	4346.30.00	430WGTZ	
26.320 FDC, FDRC, FDLC, FDLC/M, FDLRC, FDLRC/M, FNHLC, FVHLC 26S, 30S, 42S, 35S	07.08 -	D 2066 LF 38	8916.40.00	KZIZ - 5	
26.320 FDK, FDLK 26S, 30S	07.08 -	D 2066 LF 39	4300.90.56	430 10	- GBox: ZF AS-Tronic
26.320 FDS, FDLs, FDRS, FDLRS, FNHLS, FPHLS, FVHLS 26S, 30S, 35S	07.08 -	D 2066 LF 42	4319.20.00	MFZ430	- Use release fork with rollers
26.320 FD-TM 26S	07.08 -	D 2066 LF 43	4346.30.00	430WGTZ	
26.320 FNLC, FNLRC, FNLLC, FNLLRC, FNLLW, FVLC, FVL-KO 24S, 18S, 21S	07.08 -	D 2066 LF 48	8939.40.00	KZISZ - 5	
26.320 FNLS, FNLRS, FNLLS, FPLS, FVLS, FPLRS 24S, 18S, 21S	10.07 -	D 2066 LF 52	4300.90.13	430 10	- GBox: ZF AS-Tronic
26.320 FVHLC 42S	10.07 -	D 2066 LF 53	4319.20.00	MFZ430	- Use release fork with cam
26.320 FVL-KO 24S	10.07 -	D 2066 LF 64	4346.30.00	430WGTZ	
26.360 FDAC, FDALC, FDHLC, FDHLC/M 82S, 70S, 56S	10.07 -	D 2066 LF 67	8919.40.00	KZISZ - 5	
26.360 FDAK, FDALK, FDHK, FDHLK 82S, 70S, 47S, 56S	10.07 -	D 2066 LF 68	43461.30.00	430 10	- GBox: ZF Ecosplit-3
26.360 FDAS, FDALS, FDHS, FDHLS, FDHLS/M 82S, 70S, 47S, 56S	10.07 -		8950.40.00	430WGTZ	- For PTO
26.360 FDC, FDRC, FDRC/M, FDLC, FDLRC, FNHLC 26S, 30S, 42S, 35S	07.08 -		4028.10.00	KZIZ-6	- GBox: ZF Ecosplit-3
26.360 FDK, FDLK, FDRK 26S, 30S	07.08 -		4036.30.00	400	- GBox: ZF Ecosplit-3
26.360 FDS, FDRS, FDLs, FDLRS, FNHLS, FPHLS, FVHLS 78W, 26S, 30S, 42S, 30W, 35S	07.08 -		8941.40.00	MFZ2/400X	- Vehicles with double disc clutch
26.360 FD-TM 26S	10.07 -			400 10	- This part number includes one clutch disc
26.360 FNLC, FNLRC, FNLLC, FNLLRC, FVLC, FVL-KO 24S, 18S, 18W, 21S	10.07 -			400 WGTZ	- GBox: ZF Ecosplit-3
26.360 FNLLW 21S	04.08 -				- Vehicles with double disc clutch
26.360 FNLS, FNLLS, FNLRS, FPLS, FPLRS, FVLS 24S, 18S, 18W, 21S	08.08 -				
26.360 FPHLS 42S	08.08 -				
26.360 FVHLC	05.08 -				
26.360 FVHLS 42S	10.07 -				
26.360 FVL-KO 24S	05.08 -				
	10.07 -				

Vehicle list

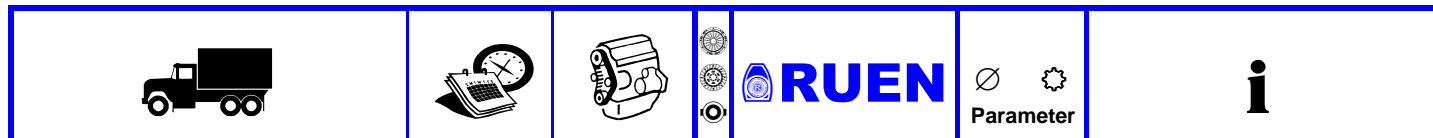

MAN

TGS

26.400 82S, 70S, 47S, 56S	11.07 -	D 2066 LF 06	4300.90.52	430 10	- GBox: ZF Ecosplit-3
26.400 FDAC, FDALC, FDHLC, FDHLC/M 82S, 70S, 56S	02.09 -	D 2066 LF 26	4319.20.00	MFZ430	
26.400 FDAK, FDALK, FDHLK, FDHK 82S, 70S, 47S, 56S	02.09 -	D 2066 LF 37	4346.30.00	430WGTZ	
26.400 FDAS, FDALS, FDHS, FDHLS, FDHLS/M 82S, 70S, 47S, 56S	09.07 -	D 2066 LF 38	8916.40.00	KZIZ - 5	
26.400 FDC, FDRC, FDC/M, FDLK, FDLK/M, FDLRC, FDLRC/M, FNHLC 78W, 26S, 30S, 42S, 35S	08.08 -	D 2066 LF 39	4300.90.56	430 10	- GBox: ZF AS-Tronic
26.400 FDK, FDLK 26S, 30S	02.09 -	D 2066 LF 41	4319.20.00	MFZ430	- Use release fork with rollers
26.400 FDS, FDLK, FDRS, FDLRS, FNHLS, FPHLS, FVHLS 78W, 26S, 30S, 42S, 30W, 35S	05.08 -	D 2066 LF 42	4346.30.00	430WGTZ	
26.400 FD-TM 26S	07.08 -	D 2066 LF 43	8939.40.00	KZISZ - 5	
26.400 FNLC, FNLRC, FNLLC, FNLLRC, FVLC, FVL-KO, FNLLW 24S, 18S, 21S	10.07 -	D 2066 LF 48	4300.90.13	430 10	- GBox: ZF AS-Tronic
26.400 FNLS, FNLRS, FNLLS, FNLLRS, FPLS, FPLRS, FVLS 24S, 18S, 18W, 21S	10.07 -	D 2066 LF 49	4319.20.00	MFZ430	- Use release fork with cam
26.400 FPHLS 42S	02.09 -	D 2066 LF 51	4346.30.00	430WGTZ	
26.400 FVHLC	02.09 -	D 2066 LF 61	8919.40.00	KZISZ - 5	
26.400 FVHLS 42S	05.08 -	D 2066 LF 63	43461.30.00	430 10	- GBox: ZF Ecosplit-3
26.400 FVL-KO 24S	10.07 -	D 2066 LF 64	8950.40.00	430WGTZ	- For PTO
28.320 FANLC, FNHLC 71S, 84S	07.08 -	D 2066 LF 67	4028.10.00	KZIZ-6	- GBox: ZF Ecosplit-3
28.320 FANLK 84S	07.08 -	D 2066 LF 68	4036.30.00	400	- For PTO
28.320 FNLC 74S, 89S	07.08 -		4036.30.00	MFZ2/400X	- GBox: ZF Ecosplit-3
28.320 FNLS 89S	07.08 -		8941.40.00	400 10	- Vehicles with double disc clutch
28.360 FANLC, FNHLC 71S, 84S	08.08 -			400 WGTZ	- This part number includes one clutch disc
28.360 FANLK 84S	08.08 -				- Vehicles with double disc clutch
28.360 FNLC, FNLRC 74S, 89S, 19W, 73W	08.08 -				
28.360 FNLS, FNLRS 89S, 19W, 73W	08.08 -				

Vehicle list



MAN

TGS

28.400 FANLC, FNHLC 71S, 84S	08.08 -	D 2066 LF 01	4300.90.52	430 10	- GBox: ZF Ecosplit-3
28.400 FANLK 84S	08.08 -	D 2066 LF 02	4319.20.00	MFZ430	
28.400 FNLC, FNLRC 74S, 89S, 19W, 73W	08.08 -	D 2066 LF 03	4346.30.00	430WGTZ	
		D 2066 LF 06	8916.40.00	KZIZ - 5	
28.400 FNLS, FBLRS 89S, 19W, 73W	08.08 -	D 2066 LF 07	4300.90.56	430 10	- GBox: ZF AS-Tronic
32.320 FFDR 49S	08.08 -	D 2066 LF 26	4319.20.00	MFZ430	- Use release fork with rollers
32.320 FFD-TM 49S	08.08 -	D 2066 LF 27	4346.30.00	430WGTZ	
32.350 FFDR 49W	02.09 -	D 2066 LF 28	8939.40.00	KZISZ - 5	
32.360 FFD-TM, FFDR-TM 49S	08.08 -	D 2066 LF 37	4300.90.13	430 10	- GBox: ZF AS-Tronic
32.390 FFDR 49W	10.07 -	D 2066 LF 38	4319.20.00	MFZ430	- Use release fork with cam
32.400 FFDR 49W,49S	06.08 -	D 2066 LF 39	4346.30.00	430WGTZ	
32.400 FFD-TM, FFDR-TM 49S	08.08 -	D 2066 LF 41	8919.40.00	KZISZ - 5	
33.350 FDAC, FDARC 56W	10.07 -	D 2066 LF 42	43461.30.00	430 10	- GBox: ZF Ecosplit-3
33.350 FDAK, FDALK 56W	06.08 -	D 2066 LF 43		430WGTZ	- For PTO
33.350 FDAS, FDALS 56W	06.08 -	D 2066 LF 48	8950.40.00	KZIZ-6	- GBox: ZF Ecosplit-3
33.360 FDAC, FDALC, FDARC 82S, 56W, 56S	06.08 -	D 2066 LF 49			- For PTO
33.360 FDAK, FDALK, FDHK, FDARK 82S, 47S, 56W, 56S	06.08 -	D 2066 LF 51	4028.10.00	400	- GBox: ZF Ecosplit-3
33.360 FDAS, FDALS, FDHS, FDARS 82S, 47S, 56W, 56S	06.08 -	D 2066 LF 53		MFZ2/400X	- Vehicles with double disc clutch
33.360 FDC, FDLC, FDLRC, FDR, FDR 26S, 26W, 30S, 76W	10.07 -	D 2066 LF 61	4036.30.00	400 10	- This part number includes one clutch disc
33.360 FDC-TM, FDR-TM 26W	10.07 -	D 2066 LF 63		400 WGTZ	- GBox: ZF Ecosplit-3
33.360 FDK, FDLK, FDRK 26S, 26W, 30S, 76W	10.07 -	D 2066 LF 64	8941.40.00		- Vehicles with double disc clutch
33.360 FDS, FDLS, FDRS 26S, 26W, 30S, 30W, 76W	06.08 -	D 2066 LF 67			- GBox: ZF Ecosplit-3
33.390 FDAC, FDALC, FDARC 56W	06.08 -	D 2066 LF 68			- Vehicles with double disc clutch
33.390 FDAK, FDARK 56W	06.08 -				
33.390 FDAS, FDARS 56W	06.08 -				
33.400 FDAC, FDALC, FDARC 82S, 56W, 56S	06.08 -				
33.400 FDAK, FDALK, FDHK, FDARK 82S, 47S, 56W, 56S	07.08 -				
33.400 FDAS, FDALS, FDHS, FDARS 82S, 47S, 56W, 56S	07.08 -				
33.400 FDC, FDLC, FDLRC, FDR, FDR 26S, 26W, 30S, 76W	07.08 -				
33.400 FDK, FDLK, FDRK 26S, 26W, 30S, 76W	06.08 -				
33.400 FDS, FDLS, FDRS 26S, 26W, 30S, 30W, 76W	06.08 -				
33.430 FDAC, FDARC 56W	07.08 -				
33.430 FDAK, FDARK 56W	07.08 -				
33.430 FDAS, FDARS 56W	07.08 -				
35.320 FFDC, FFDLC, FDNLC 92S, 41S, 37S	07.08 -				
35.320 FFDK, FFDLK, FFDK 41S,37S	06.08 -				
35.320 FFD-TM 37S	06.08 -				
35.320 FFNHLC 73S	10.07 -				
35.320 FFNLC 90S	10.07 -				
35.350 FDAC, FDARC 56W	10.07 -				

Vehicle list

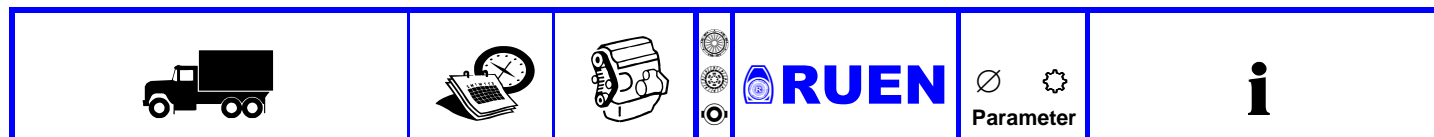

MAN

TGS

35.360 FFDK, FFDHLK 59S, 93S	06.08 -	D 2676 LF 04		4300.90.52	430 10	- GBox: ZF Ecosplit-3
35.360 FFDC, FFDLC, FDNLC 92S, 41S, 37S	06.08 -	D 2066 LF 01		4319.20.00	MFZ430	
35.360 FFDK, FFDLK, FFDK 41S, 37S	08.08 -	D 2066 LF 02		4346.30.00	430WGTZ	
35.360 FFD-TM 37S	10.07 -	D 2066 LF 06		8916.40.00	KZIZ - 5	
35.360 FFD-TM 37S	10.07 -	D 2066 LF 07		4300.90.56	430 10	- GBox: ZF AS-Tronic
35.360 FFD-TM 37S	10.07 -	D 2066 LF 26		4319.20.00	MFZ430	- Use release fork with rollers
35.360 FFD-TM 37S	10.07 -	D 2066 LF 26		4346.30.00	430WGTZ	
35.360 FFD-TM 37S	10.07 -	D 2066 LF 27		8939.40.00	KZISZ - 5	
35.390 FFDK 60W	06.08 -	D 2066 LF 28				
35.400 FFDK, FFDLC, FDNLC 92S, 41S, 37S	06.08 -	D 2066 LF 37		4300.90.13	430 10	- GBox: ZF AS-Tronic
35.400 FFDK, FFDLK, FFDK 41S, 37S	08.08 -	D 2066 LF 38		4319.20.00	MFZ430	- Use release fork with cam
35.400 FFDK, FFDLK, FFDK 41S, 37S	08.08 -	D 2066 LF 39		4346.30.00	430WGTZ	
35.400 FFD-TM 37S	10.07 -	D 2066 LF 41		8919.40.00	KZISZ - 5	
35.400 FFD-TM 37S	10.07 -	D 2066 LF 42				
35.400 FFD-TM 37S	10.07 -	D 2066 LF 43		43461.30.00	430 10	- GBox: ZF Ecosplit-3
35.400 FFD-TM 37S	10.07 -	D 2066 LF 43			430WGTZ	- For PTO
35.400 FFD-TM 37S	10.07 -	D 2066 LF 48		8950.40.00	KZIZ-6	- GBox: ZF Ecosplit-3
35.430 FFDK 60W	06.08 -	D 2066 LF 49				- For PTO
37.320 FFDK 39S	07.08 -	D 2066 LF 50		4028.10.00	400	- GBox: ZF Ecosplit-3
37.320 FFDK 39S	07.08 -	D 2066 LF 51			MFZ2/400X	- Vehicles with double disc clutch
37.320 FFD-TM 39S	10.07 -	D 2066 LF 52				- This part number includes one clutch disc
37.360 FFDK 39S	07.08 -	D 2066 LF 61		4036.30.00	400 10	- GBox: ZF Ecosplit-3
37.360 FFDK 39S	07.08 -	D 2066 LF 62			400 WGTZ	- Vehicles with double disc clutch
37.360 FFD-TM 39S	10.07 -	D 2066 LF 63		8941.40.00	KZISZ-5	- GBox: ZF Ecosplit-3
37.400 FFDK 39S	07.08 -	D 2066 LF 64				- Vehicles with double disc clutch
37.400 FFDK 39S	07.08 -	D 2066 LF 67				
37.400 FFD-TM 39S	10.07 -	D 2066 LF 68				
40.360 FDS, FDRS 34W	06.08 -	D 2676 LF 02				
40.390 FDK, FDRK 34W	06.08 -	D 2676 LF 03				
40.390 FDS, FDRS 34W	06.08 -	D 2676 LF 20				
40.400 FDK, FDRK 34W, 77W	06.08 -					
40.400 FDS, FDRS 34W	06.08 -					
40.430 FDK, FDRK 34W	06.08 -					
40.430 FDS, FDRS 34W	06.08 -					
40.440 FDK, FDRK 34W	06.08 -					
40.440 FDK, FDRK 34W, 77W	06.08 -					
40.440 FDS, FDRS 34W, 12412cc	06.08 -					
40.440 FDS, FDRS 34W, 10518cc	06.08 -					
40.480 FDK, FDRK 34W, 77W	06.08 -					
40.480 FDS, FDRS 34W	06.08 -					
41.320 FFDK 93S	06.08 -					
41.360 FFD, FFDC, FFDRC 79W, 39W, 39S	07.08 -					
41.360 FFDK 93S	07.08 -					
41.360 FFDK 96S, 60W	07.08 -					
41.360 FFDK, FFDK 79W, 39W, 39S	07.08 -					
41.360 FFD-TM, FFDC-TM, FFDRC-TM 79W, 39W, 39S	10.07 -					
41.390 FFDK 60W	06.08 -					
41.400 FFD, FFDC, FFDRC 79W, 39W, 39S	07.08 -					
41.400 FFDK 93S	07.08 -					
41.400 FFDK 96S, 60W	07.08 -					
41.400 FFDK, FFDK 79W, 39W, 39S	07.08 -					
41.400 FFDK, FFDK 79W, 39W, 39S	07.08 -					
41.430 FFDK 60W	07.08 -					

Vehicle list

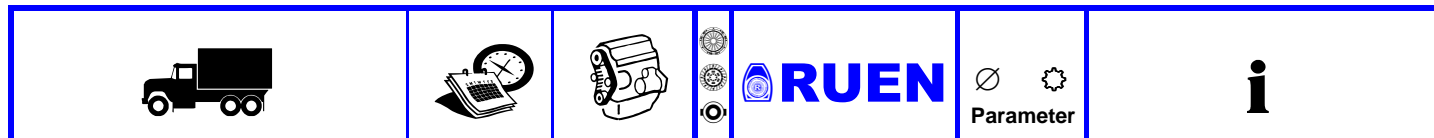

MAN

TGS

18.480 FC, FLC, FLRC, FLLC, FLLRC, FLLW, FLLW/N 06S, 10S, 03S, 15S	10.07 -	D 2676 LF 02		4300.90.101	430 10	- GBox: ZF Ecosplit-3
18.480 FK, FK-L, FLK, FLK/M 06S, 03S	10.07 -	D 2676 LF 03		4386.20.00	MFZ430	
18.480 FLS, FLS/M, FLS-TS, FLRS, FLRS/M, FLLS, FLLS/N, FLLRS 06S, 10S, 13S, 08S	10.07 -	D 2676 LF 05		4386.30.00	430WGTZ	
18.540 FAS, FALS, FHLS, FHLS/M 22S 80S, 52S	10.07 -	D 2676 LF 06		8916.40.00	KZIZ - 5	
24.480 FNLLW/N 45S	10.07 -	D 2676 LF 07		4300.90.102	430 10	- GBox: ZF Ecosplit-3
24.480 FPLS, FPLRS 24S	10.07 -	D 2676 LF 13		4386.20.00	MFZ430	
26.480 FDAC, FDALC, FDHLC 82S, 70S, 56S	02.09 -	D 2676 LF 14		4386.30.00	430WGTZ	
26.480 FDAK, FDALK, FDHK, FDHLK 82S, 70S, 47S, 56S	02.09 -	D 2676 LF 20		8916.40.00	KZIZ - 5	
26.480 FDAS, FDALS, FDHS, FDHLS 82S, 70S, 47S, 56S	02.09 -	D 2676 LF 25		4300.90.105	430 10	- GBox: ZF AS-Tronic
26.480 FDC, FDC/M, FDLC, FDRC, FDLRC, FNLHC, FVHLC 78W, 26S, 30S, 42S, 35S	02.09 -			4386.20.00	MFZ430	- Use release fork with rollers
26.480 FDK, FDLK 26S, 30S	07.08 -			4386.30.00	430WGTZ	
26.480 FDS, FDLS, FDRS, FDLRS, FNHLS, FPHLS, FVHLS 78W, 26S, 30S, 42S, 30W, 35S	05.08 -			8939.40.00	KZISZ - 5	
26.480 FD-TM 26S	05.08 -			4300.90.103	430 10	- GBox: ZF AS-Tronic
26.480 FNLC, FNLRC, FNLLC, FNLLRC, FNLLW, FVLC, FVL-KO 24S, 18S, 18W, 21S	10.07 -			4386.20.00	MFZ430	- Use release fork with cam
26.480 FNLS, FNLLS, FNLRS, FPLS, FPLRS, FVLS 24S, 18S, 18W, 21S	02.09 -			4386.30.00	430WGTZ	
26.480 FPHLS 42S	05.08 -			8919.40.00	KZISZ - 5	
26.480 FVHLC 42S	10.07 -			43461.30.00	430 10	- GBox: ZF Ecosplit-3
26.480 FVHLS 42S	05.08 -			8950.40.00	430WGTZ	- For PTO
26.480 FVL-KO 24S	10.07 -			4028.10.00	400	- GBox: ZF Ecosplit-3
26.540 FDAC, FDALC, FDHLC, FDHLC/M 82S, 70S, 56S	02.09 -			4036.30.00	MFZ2/400X	- Vehicles with double disc clutch
26.540 FDAK, FDALK, FDHLK 82S, 70S, 56S	11.07 -			4036.30.00	400 WGTZ	- This part number includes one clutch disc
26.540 FDAS, FDALS, FDHLS 82S, 70S, 56S	02.09 -			8941.40.00	KZISZ-5	- GBox: ZF Ecosplit-3
26.540 FDC, FDC/M, FDLC, FDLC/M, FDLRC, FNHLC, FVHLC 26S, 30S, 35S	02.09 -					- Vehicles with double disc clutch
26.540 FDK, FDLK 26S, 30S	02.09 -					
26.540 FDS, FDLS, FDRS, FDLRS, FNHLS, FPHLS, FVHLS 26S, 30S, 42S, 35S	05.08 -					

Vehicle list





























MAN

TGS

28.540 FANLC, FNHLC 71S, 84S	06.08 -	D 2676 LF 02	4300.90.101	430 10	- GBox: ZF Ecosplit-3
28.540 FANLK 84S	06.08 -	D 2676 LF 03	4386.20.00	MFZ430	
28.540 FNLC 74S,89S	02.09 -	D 2676 LF 05	4386.30.00	430WGTZ	
	02.09 -	D 2676 LF 06	8916.40.00	KZIZ - 5	
28.540 FNLS 89S	02.09 -	D 2676 LF 07	4300.90.102	430 10	- GBox: ZF Ecosplit-3
33.480 FDAC, FDALC, FDARC 82S, 56W, 56S	08.08 -	D 2676 LF 13	4386.20.00	MFZ430	
33.480 FDAK, FDALK, FDARK, FDHK 82S, 47S, 56W, 56S	08.08 -	D 2676 LF 14	4386.30.00	430WGTZ	
33.480 FDAS, FDALS, FDHS, FDARS 82S, 47S, 56W, 56S	10.07 -	D 2676 LF 20	8916.40.00	KZIZ - 5	
33.480 FDC, FDC/M, FDLC, FDLC/M, FDLRC, FDR, FDRC 26S, 26W, 30S, 76W	08.08 -	D 2676 LF 25	4300.90.105	430 10	- GBox: ZF AS-Tronic - Use release fork with rollers
33.480 FDC-TM, FDRC-TM 26W	08.08 -		4386.20.00	MFZ430	
33.480 FDK, FDLK 26S, 26W, 30S, 76W	08.08 -		4386.30.00	430WGTZ	
33.480 FDK, FDLK 26S, 26W, 30S, 76W	08.08 -		8939.40.00	KZISZ - 5	
33.480 FDS, FDLS, FDLS/M, FDRS 26S, 26W, 30S, 30W, 76W	08.08 -		4300.90.103	430 10	- GBox: ZF AS-Tronic - Use release fork with cam
33.540 FDAC, FDALC 82S, 56S	02.09 -		4386.20.00	MFZ430	
33.540 FDC, FDLC, FDLC/M, FDLRC, FDRC 26S,30S	02.09 -		4386.30.00	430WGTZ	
33.540 FDK, FDLK 26S, 30S	02.09 -		8919.40.00	KZISZ - 5	
33.540 FDS, FDLS, FDLS/M 26S, 30S	02.09 -		43461.30.00	430 10 430WGTZ	- GBox: ZF Ecosplit-3 - For PTO
	02.09 -		8950.40.00	KZIZ-6	- GBox: ZF Ecosplit-3 - For PTO
	02.09 -		4028.10.00	400 MFZ2/400X	- GBox: ZF Ecosplit 3 - Vehicles with double disc clutch - This part number includes one clutch disc
	02.09 -		4036.30.00	400 10 400 WGTZ	- GBox: ZF Ecosplit-3 - Vehicles with double disc clutch
	02.09 -		8941.40.00	KZISZ-5	- GBox: ZF Ecosplit 3 - Vehicles with double disc clutch

Vehicle list

					
---	---	---	--	---	---

MAN					
TGS					
18.440 FAC, FHLC 22S, 52W, 52S	10.07 -	D 2066 LF 25	 4300.90.101	430 10	- GBox: ZF Ecosplit 3
18.440 FAK, FAK-L, FALK, FALK-L, FHLK, FHLK/M 22S, 52W, 80S, 52S	10.07 -	D 2066 LF 36	 4386.20.00	MFZ430	
18.440 FAS, FALS, FHLS, FHLS/M 22S 52W, 80S, 52S	10.07 -	D 2066 LF 40	 4386.30.00	430WGTZ	
18.440 FC, FLC, FLRC, FLLC, FLLRC, FLLW, FLLW/N 06S, 10S, 03S, 15S	10.07 -	D 2066 LF 50	 8916.40.00	KZIZ - 5	
18.440 FC, FLC, FLRC, FLLC, FLLRC, FLLW, FLLW/N 06S, 10S, 03S, 15S	10.07 -	D 2066 LF 62	 4300.90.102	430 10	- GBox: ZF Ecosplit 3
18.440 FK, FK-L, FLK, FLK/M 06S, 03S	10.07 -	D 2676 LF 22	 4386.20.00	MFZ430	
18.440 FLS, FLS/M, FLS-TS, FLRS, FLRS/M, FLLS, FLLS/N, FLLRS 06S, 10S, 13S, 08S	10.07 -	D 2676 LF 26	 4386.30.00	430WGTZ	
26.440 FDAC, FDALC, FDHLC, FDHLC/M 82S, 70S, 56S	02.09 -		 8916.40.00	KZIZ - 5	
26.440 FDK, FDLK, FDHK, FDHLK 82S, 70S, 47S, 56S	11.07 -		 4300.90.56	430 10	- GBox: ZF AS-Tronic - Use release fork with rollers
26.440 FDAS, FDALS, FDHS, FDHLS, FDHLS/M 82S, 70S, 47S, 56S	02.09 -		 4319.20.00	MFZ430	
26.440 FDC, FDRS, FDC/M, FDLC, FDLC/M, FDLRC, FNHLC, FVHLC 78W, 26S, 30S, 42S, 35S	02.09 -		 4346.30.00	430WGTZ	
26.440 FDK, FDLK 26S, 30S	02.09 -		 8939.40.00	KZISZ - 5	
26.440 FDS, FDRS, FDLK, FDLRS, FNHLS, FPHLS, FVHLS 78W, 26S, 30S, 42S, 30W, 35S	05.08 -		 4300.90.13	430 10	- GBox: ZF AS-Tronic - Use release fork with cam
26.440 FD-TM 26S	07.08 -		 4319.20.00	MFZ430	
26.440 FNLC, FNLLC, FNLLRC, FNLLW, FNLR, FVLC 24S, 18S, 21S	10.07 -		 4346.30.00	430WGTZ	
26.440 FNLC, FNLLC, FNLLW, FNLR, FNLLRC, FVLC, FVL-KO 24S, 18S, 18W, 21S	10.07 -		 43461.30.00	430 10 430WGTZ	- GBox: ZF Ecosplit 3 - For PTO
26.440 FNLS, FNLLS, FNLR, FNLR, FPLS, FPLRS, FVLS 24S, 18S	10.07 -		 8950.40.00	KZIZ-6	- GBox: ZF Ecosplit 3 - For PTO
26.440 FNLS, FNLLS, FNLR, FPLS, FPLRS, FVLS 24S, 18S, 18W, 21S	10.07 -		 4028.10.00	400 MFZ2/400X	- GBox: ZF Ecosplit 3 - Vehicles with double disc clutch - This part number includes one clutch disc
26.440 FNLS, FNLLS, FNLR, FPLS, FPLRS, FVLS 24S, 18S, 18W, 21S	02.09 -		 4036.30.00	400 10 400 WGTZ	- GBox: ZF Ecosplit-3 - Vehicles with double disc clutch
26.440 FNLS, FNLLS, FNLR, FPLS, FPLRS, FVLS 24S, 18S, 18W, 21S	10.07 -		 8941.40.00	KZISZ-5	- GBox: ZF Ecosplit 3 - Vehicles with double disc clutch
26.440 FPHLS 42S	05.08 -				
26.440 FVHLC 42S	10.07 -				
26.440 FVHLS 42S	05.08 -				
26.440 FVL-KO 24S	10.07 -				
28.440 FANLK 84S	08.08 -				
28.440 FNLC, FNLR 74S, 89S, 19W, 73W	08.08 -				
28.440 FNLS, FNLR 89S, 19W, 73W	08.08 -				
32.440 FFDRC 49S	08.08 -				
32.440 FFD-TM, FFDR-TM 49S	10.07 -				

Vehicle list



MAN

TGS

33.440 FDAC, FDALC, FDARC 82S, 56W, 56S	07.08 -	D 2676 LF 04		4300.90.101	430 10	- GBox: ZF Ecosplit 3
33.440 FDAK, FDALK, FDHK, FDARK 82S, 47S, 56W, 56S	11.07 -	D 2066 LF 25		4386.20.00	MFZ430	
		D 2066 LF 36		4386.30.00	430WGTZ	
33.440 FDAS, FDALS, FDHS, FDARS 82S, 47S, 56W, 56S	10.07 -	D 2066 LF 40		8916.40.00	KZIZ - 5	
33.440 FDC, FDLC, FDLRC, FDR, FDRC 26S, 26W, 30S, 76W	06.08 -	D 2066 LF 50		4300.90.102	430 10	- GBox: ZF Ecosplit 3
33.440 FDC-TM, FDRC-TM 26W	06.08 -	D 2066 LF 62		4386.20.00	MFZ430	
		D 2676 LF 26		4386.30.00	430WGTZ	
				8916.40.00	KZIZ - 5	
33.440 FDS, FDLS, FDLs/M, FDRS 26S, 26W, 30S, 30W, 76W	06.08 -			4300.90.56	430 10	- GBox: ZF AS-Tronic
35.440 FDNLC, FFDC, FFDLC 92S, 42S, 41S, 37S	06.08 -			4319.20.00	MFZ430	- Use release fork with rollers
				4346.30.00	430WGTZ	
35.440 FFDK 96S, 60W	06.08 -			8939.40.00	KZISZ - 5	
35.440 FFDK, FFDHLK 59S, 93S	06.08 -			4300.90.13	430 10	- GBox: ZF AS-Tronic
35.440 FFDK, FFDLK, FFDK 41S, 37S	08.08 -			4319.20.00	MFZ430	- Use release fork with cam
				4346.30.00	430WGTZ	
35.440 FFD-TM 37S	10.07 -			8919.40.00	KZISZ - 5	
35.440 FFNHLC 73S	10.07 -			43461.30.00	430 10	- GBox: ZF Ecosplit 3
	06.08 -			8950.40.00	430WGTZ	- For PTO
35.440 FFNLC 90S	06.08 -			4028.10.00	KZIZ-6	- GBox: ZF Ecosplit 3
37.440 FFDC 39S	07.08 -			4036.30.00	400	- GBox: ZF Ecosplit 3
37.440 FFDK 39S	07.08 -			4028.10.00	MFZ2/400X	- Vehicles with double disc clutch
37.440 FFD-TM 39S	10.07 -			4036.30.00	400	- This part number includes one clutch disc
41.440 FFD, FFDC, FFDRC 79W, 39W, 39S	07.08 -			4036.30.00	400 10	- GBox: ZF Ecosplit-3
41.440 FFDK 93S	06.08 -			8941.40.00	400 WGTZ	- Vehicles with double disc clutch
41.440 FFDK 96S, 60W	06.08 -			8941.40.00	KZISZ-5	- GBox: ZF Ecosplit 3
41.440 FFDARC 96S	06.08 -			8941.40.00		- Vehicles with double disc clutch
41.440 FFDC-TM, FFDRC-TM, FFD-TM 79W, 39W, 39S	10.07 -			8941.40.00		
41.440 FFDC-TM, FFDRC-TM, FFD-TM 79W, 39W, 39S	06.08 -			8941.40.00		
41.440 FFDK 39S	07.08 -			8941.40.00		
41.440 FFDK, FFDK 79W, 39W, 39S	10.07 -			8941.40.00		
	06.08 -			8941.40.00		

Vehicle list



MAN

TGS

18.480 FAC, FHLC 22S, 52W, 52S	10.07 -	D 2676 LF 04		4300.90.102	430 10	- GBox: ZF Ecosplit 3
18.480 FAK, FAK-L, FALK, FALK-L, FHLK, FHLK/M 22S, 80S, 52S	10.07 -	D 2066 LF 36		4386.20.00	MFZ430	
18.480 FAS, FALS, FHLS 22S, 52W, 80S, 52S	10.07 -	D 2066 LF 40		4386.30.00	430WGTZ	
18.540 FAC, FHLC 22S, 52S	10.07 -	D 2066 LF 50		8916.40.00	KZIZ - 5	
18.540 FAK, FAK-L, FALK, FALK-L, FHLK, FHLK/M 22S, 80S, 52S	10.07 -	D 2066 LF 62		4300.90.105	430 10	- GBox: ZF AS-Tronic
26.440 FDAC, FDALC, FDHLC 82S, 70S, 56S	10.07 -	D 2676 LF 02		4386.20.00	MFZ430	- Use release fork with rollers
26.440 FDAK, FDALK, FDHK, FDHLK 82S, 70S, 56S	10.07 -	D 2676 LF 05		4386.30.00	430WGTZ	
26.440 FDAS, FDALS, FDHS, FDHLS 82S, 70S, 56S	02.09 -	D 2676 LF 06		8939.40.00	KZISZ - 5	
26.440 FDC, FDRS, FDLK, FDLRS, FNHLC, FVHLC 78W, 26S, 30S, 35S	02.09 -	D 2676 LF 07		8919.40.00	KZISZ - 5	- GBox: ZF AS-Tronic
26.440 FDK, FDLK 26S, 30S	02.09 -	D 2676 LF 13		43461.30.00	430 10	- Use release fork with cam
26.440 FDS, FDRS, FDLK, FDLRS, FNHLS, FPHLS, FVHLS 78W, 26S, 30S, 35S	02.09 -	D 2676 LF 14		8950.40.00	430WGTZ	- GBox: ZF Ecosplit 3
26.440 FD-TM 26S	02.09 -	D 2676 LF 20		4028.10.00	KZIZ-6	- For PTO
28.480 FANLC, FNHLC 71S, 84S	07.08 -	D 2676 LF 22		8950.40.00	KZIZ-6	- GBox: ZF Ecosplit 3
28.480 FANLK 84S	05.08 -	D 2676 LF 25		4036.30.00	400 10	- GBox: ZF Ecosplit-3
28.480 FNLC, FNLRC 74S, 89S, 19W, 73W	08.08 -	D 2676 LF 26		8941.40.00	400 WGTZ	- Vehicles with double disc clutch
28.480 FNLS, FNLRS 89S, 19W, 73W	08.08 -					- This part number includes one clutch disc
32.480 FFDRC 49S	08.08 -					
32.480 FFD-TM 49S	08.08 -					
33.440 FDK, FDLK, FDRK 26S, 26W, 30S, 76W	06.08 -					
35.440 FFDAC 96S	06.08 -					
35.440 FFDAC, FFDHLK 59S, 93S	06.08 -					
35.440 FFDK, FFDLK, FFDRK 41S, 37S	08.08 -					
35.440 FFD-TM 37S	08.08 -					
35.440 FFNHLC 73S	06.08 -					
35.440 FFNLC 90S	06.08 -					
35.480 FDNLC, FFDC, FFDLC 92S, 41S, 37S	06.08 -					
35.480 FFDAC 96S, 60W	06.08 -					
35.480 FFDAC, FFDHLK 59S, 93S	06.08 -					
35.480 FFDK, FFDLK, FFDRK 41S, 37S	08.08 -					
35.480 FFD-TM 37S	10.07 -					
35.480 FFNHLC 73S	10.07 -					
35.480 FFNLC 73S	06.08 -					
35.540 FDNLC, FFDC, FFDLC 92S, 41S, 37S	06.08 -					
35.540 FFDAC 96S	02.09 -					
35.540 FFDAC, FFDHLK 59S, 93S	02.09 -					
35.540 FFDK, FFDLK, FFDRK 41S, 37S	02.09 -					
35.540 FFD-TM 37S	10.07 -					
35.540 FFNHLC 73S	06.08 -					
35.540 FFNLC 90S	02.09 -					
37.440 FFDC 39S	07.08 -					
37.440 FFDK 39S	07.08 -					

Vehicle list

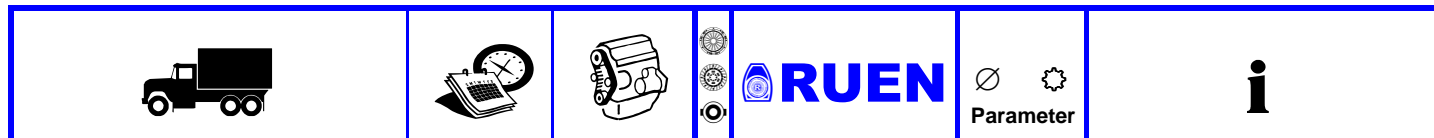

MAN

TGS

18.440 FC, FLC, FLRC, FLLC, FLLRC, FLLW, FLLW/N 06S, 10S, 03S, 15S	10.07 -	D 2676 LF 04		4300.90.102	430 10	- GBox: ZF Ecosplit 3
18.440 FLS, FLS/M, FLS-TS, FLRS, FLRS/M, FLLS, FLLS/N, FLLRS 06S, 10S, 13S, 08S	10.07 -	D 2066 LF 02		4386.20.00	MFZ430	
24.440 FNLLW/N 45S	10.07 -	D 2676 LF 02		4386.30.00	430WGTZ	
24.440 FPLS, FPLRS 24S	10.07 -	D 2676 LF 03		8916.40.00	KZIZ - 5	
26.440 FNLC, FNLLC, FNLLRC, FNLLW, FNLR, FVLC 24S, 18S, 21S	10.07 -	D 2676 LF 05		4300.90.105	430 10	- GBox: ZF AS-Tronic
26.440 FNLS, FNLLS, FNLRS, FPLS, FPLRS, FVLS 24S, 18S	10.07 -	D 2676 LF 06		4386.20.00	MFZ430	- Use release fork with rollers
28.440 FANLK 84S	10.07 -	D 2676 LF 07		4386.30.00	430WGTZ	
28.440 FNLC, FNLRC 74S, 89S	10.07 -	D 2676 LF 13		8939.40.00	KZISZ - 5	
28.440 FNLS, FNLRS 89S	10.07 -	D 2676 LF 14		8919.40.00	KZISZ - 5	- GBox: ZF AS-Tronic
32.440 FFDC 49S	08.08 -	D 2676 LF 20		43461.30.00	430 10	- Use release fork with rollers
32.440 FFD-TM, FFDR-TM 49S	08.08 -	D 2676 LF 22		8950.40.00	430WGTZ	- For PTO
33.440 FDAC, FDALC, FDARC 82S, 56W, 56S	08.08 -	D 2676 LF 25		4028.10.00	400	- GBox: ZF Ecosplit 3
33.440 FDAK, FDALK, FDARK, FDHK 82S, 56W, 56S	08.08 -	D 2676 LF 26		4036.30.00	MFZ2/400X	- Vehicles with double disc clutch
33.440 FDAS, FDALS, FDARS, FDHS 82S, 56W, 56S	07.08 -			8941.40.00	400 10	- This part number includes one clutch disc
33.440 FDC, FDLC, FDLRC, FDR, FDRC 26S, 26W, 30S, 76W	07.08 -				400 WGTZ	- GBox: ZF Ecosplit-3
33.440 FDS, FDLS, FDLS/M, FDRS 26S, 26W, 30S, 30W, 76W	07.08 -					- Vehicles with double disc clutch
37.440 FFD-TM 39S	08.08 -					- GBox: ZF Ecosplit 3
37.480 FFDC 39S	10.07 -					- Vehicles with double disc clutch
37.480 FFDK 39S	10.07 -					
37.480 FFD-TM 39S	07.08 -					
37.540 FFDC 39S	07.08 -					
37.540 FFDK 39S	07.08 -					
37.540 FFD-TM 39S	07.08 -					
41.390 FFDK, FFDRK 39W	02.09 -					
41.440 FFD, FFDC, FFDC 79W, 39W, 39S	10.07 -					
41.440 FFDAK 93S	02.09 -					
41.480 FFD, FFDC, FFDC 79W, 39W, 39S	02.09 -					
41.480 FFDAK 93S	02.09 -					
41.480 FFDAK 96S, 60W	02.09 -					
41.480 FFDC, FFDC, FFDC 96S	02.09 -					
41.480 FFDC-TM, FFDC-TM, FFD-TM 79W, 39W, 39S	02.09 -					
41.480 FFDK, FDRK 79W, 39W, 39S	02.09 -					
41.540 FFDAK 93S	10.07 -					
41.540 FFDAK 96S	10.07 -					
41.540 FFDC 39S	10.07 -					
41.540 FFDK 39S	10.07 -					
41.540 FFD-TM 39S	10.07 -					

Vehicle list



MAN

TGS

18.540 FC, FLC, FLRC, FLLC, FLLRC, FLLW, FLLW/N 06S, 10S, 03S 18.540 FK, FK-L, FLK, FLK/M 06S, 03S 18.540 FLS, FLS/M, FLRS, FLRS/M, FLLS, FLLS/N, FLLRS 06S, 10S, 08S 24.540 FPLS, FPLRS 24S 26.540 FNLC, FNLRC, FNLLC, FNLLRC, FNLLW, FVLC, FVL-KO 24S, 18S, 21S 26.540 FNLS, FNLLS, FPLS, FPLRS, FVLS, FNLRS, FNLS 24S, 18S, 21S 26.540 FVL-KO 24S	10.07 -	D 2676 LF 06		4300.90.101	430 10	- Engine code: D2676LF13 EURO 5 - GBox: ZF Ecosplit-3	
		10.07 -	D 2676 LF 13		4386.20.00	MFZ430	
		10.07 -			4386.30.00	430WGTZ	
		10.07 -			8916.40.00	KZIZ - 5	
		10.07 -			4300.90.102	430 10	- Engine code: D2676LF13 EURO 5 - GBox: ZF Ecosplit-3
		10.07 -			4386.20.00	MFZ430	
		10.07 -			4386.30.00	430WGTZ	
		10.07 -			8916.40.00	KZIZ - 5	
		10.07 -			4300.90.105	430 10	- Engine code: D2676LF13 EURO 5 - GBox: ZF AS-Tronic - Use release fork with rollers
		02.09 -			4386.20.00	MFZ430	
	02.09 -			4386.30.00	430WGTZ		
	02.09 -			8939.40.00	KZISZ - 5		
	10.07 -			4300.90.103	430 10	- Engine code: D2676LF13 EURO 5 - GBox: ZF AS-Tronic - Use release fork with cam	
				4386.20.00	MFZ430		
				4386.30.00	430WGTZ		
				8919.40.00	KZISZ - 5		
				43461.30.00	430 10	- Engine code: D2676LF13 EURO 5 - GBox: ZF Ecosplit-3 - For PTO	
				430WGTZ			
				8950.40.00	KZIZ-6	- Engine code: D2676LF13 EURO 5 - GBox: ZF Ecosplit-3 - For PTO	
				4028.10.00	400	- Engine code: D2676LF13 EURO 5 - GBox: ZF Ecosplit-3 - Vehicles with double disc clutch - This part number includes one clutch disc	
				MFZ2/400X			
				4036.30.00	400 10	- Engine code: D2676LF13 EURO 5 - GBox: ZF Ecosplit-3 - Vehicles with double disc clutch	
				400 WGTZ			
				8941.40.00	KZISZ-5	- Engine code: D2676LF13 EURO 5 - GBox: ZF Ecosplit-3 - Vehicles with double disc clutch	

Vehicle list



MAN

TGS

19.350 FLRS, FLS, FRS, FS 72W, 06W, 71W, 03W	10.07 -	D 2066 LF 01		4300.90.52	430 10	- GBox: ZF Ecosplit 3
19.360 FS, FLS, FRS, FLRS 72W, 06W, 71W, 03W	02.11 -	D 2066 LF 02		4319.20.00	MFZ430	
19.390 FLRS, FLS, FRS, FS 72W, 06W, 71W, 03W	06.08 -	D 2066 LF 03		4346.30.00	430WGTZ	
19.400 FS/M-WW, FLS/M-WW, FRS/M-WW, FLRS/M-WW 72W, 06W, 71W, 03W	02.11 -	D 2066 LF 04		8916.40.00	KZIZ - 5	
19.430 FLRS, FLS, FRS, FS 72W, 06W, 71W, 03W	10.07 -	D 2066 LF 06		4300.90.56	430 10	- GBox: ZF AS-Tronic
19.440 FS-WW, FRS-WW, FLS-WW, FLRS-WW 72W, 06W, 71W, 03W	02.11 -	D 2066 LF 07		4319.20.00	MFZ430	- Use release fork with rollers
21.360 FS, FLS 72W, 06W, 71W, 03W	10.07 -	D 2066 LF 40		4346.30.00	430WGTZ	
21.400 FS, FLS 72W, 06W, 71W, 03W	10.07 -	D 2066 LF 48		8939.40.00	KZISZ - 5	
21.440 FS, FLS 72W, 06W, 71W, 03W	10.07 -	D 2066 LF 49		43461.30.00	430 10	- GBox: ZF Ecosplit 3
26.350 FDLC, FDLRC 78W	10.07 -	D 2066 LF 50		8950.40.00	430WGTZ	- For PTO
26.350 FDLS, FDLRS 78W, 30W	10.07 -	D 2066 LF 62		4028.10.00	KZIZ-6	- GBox: ZF Ecosplit 3
26.350 FNLC, FNLRC 18W	10.07 -	D 2066 LF 63		4036.30.00	400	- For PTO
26.350 FNLS, FNLRS 18W	10.07 -	D 2066 LF 64		8941.40.00	400 10	- GBox: ZF Ecosplit 3
26.390 FDLC, FDLRC 78W	06.08 -				400 WGTZ	- Vehicles with double disc clutch
26.390 FDLS, FDLRS 78W, 30W	06.08 -					- This part number includes one clutch disc
26.390 FNLC, FNLRC 18W	06.08 -					- GBox: ZF Ecosplit 3
26.390 FNLS, FNLRS 18W	06.08 -					- Vehicles with double disc clutch
26.430 FDLC, FDLRC 78W	10.07 -					- GBox: ZF Ecosplit 3
26.430 FDLS, FDLRS 78W, 30W	10.07 -					- Vehicles with double disc clutch
26.430 FNLC, FNLRC 18W	10.07 -					- GBox: ZF Ecosplit 3
26.430 FNLS, FNLRS 18W	10.07 -					- Vehicles with double disc clutch
28.350 FNLLC, FNLC, FNLRC 19W,73W	08.08 -					
28.350 FNLRS, FNLS 19W,73W	08.08 -					
28.390 FNLC, FNLRC 19W,73W	06.08 -					
28.390 FNLS, FNLRS 19W, 73W	06.08 -					
28.430 FNLC, FNLRC 19W, 73W	08.08 -					
28.430 FNLS, FNLRS 19W, 73W	08.08 -					
33.350 FDC, FDLC, FDR, FDRC 26W, 76W	06.08 -					
33.350 FDC-TM, FDRC-TM 26W	06.08 -					
33.350 FDK, FDRK 26W, 76W	06.08 -					
33.350 FDLS, FDRS, FDS 26W, 30W, 76W	06.08 -					
33.390 FDC, FDR, FDRC 26W, 76W	06.08 -					
33.390 FDC-TM, FDRC-TM 26W	06.08 -					
33.390 FDK, FDRK 26W, 76W	06.08 -					
33.390 FDLS, FDRS, FDS 26W, 30W, 76W	06.08 -					
33.400 FDC-TM, FDRC-TM 26W	07.08 -					
33.430 FDC, FDLC, FDR, FDRC 26W, 76W	06.08 -					
33.430 FDC-TM, FDRC-TM 26W	06.08 -					
33.430 FDK, FDRK 26W, 76W	06.08 -					
33.430 FDLS, FDRS, FDS 26W, 30W, 76W	06.08 -					
40.360 FDAK, FDARK 58W	06.08 -					
40.360 FDAS, FDARS 58W	10.07 -					
40.360 FDK, FDRK 34W, 77W	06.08 -					

Vehicle list

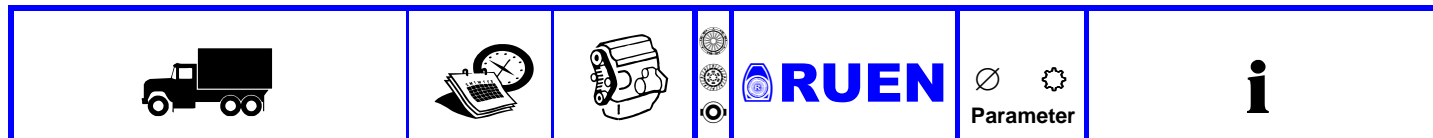

MAN

TGS

40.390 FDAK, FDARK 58W	10.07 -	D 2066 LF 01		4300.90.52	430 10	- GBox: ZF Ecosplit 3
40.390 FDAS, FDARS 58W	10.07 -	D 2066 LF 02		4319.20.00	MFZ430	
40.400 FDAK-WW, FDARK-WW 58W	02.11 -	D 2066 LF 03		4346.30.00	430WGTZ	
40.400 FDAS-WW, FDARS-WW 58W	02.11 -	D 2066 LF 06		8916.40.00	KZIZ - 5	
40.430 FDAK, FDARK 58W	06.08 -	D 2066 LF 49		4300.90.56	430 10	- GBox: ZF AS-Tronic
40.430 FDAS, FDARS 58W	06.08 -	D 2066 LF 50		4319.20.00	MFZ430	- Use release fork with cam
40.440 FDAK-WW, FDARK-WW 58W	02.11 -	D 2066 LF 62		4346.30.00	430WGTZ	
40.440 FDAS-WW, FDARS-WW 58W	02.11 -	D 2066 LF 63		8939.40.00	KZISZ - 5	
41.350 FFDC, FFDRK 39W	06.08 -			43461.30.00	430 10	- GBox: ZF Ecosplit 3
41.350 FFDC-TM, FFDRK-TM 39W	06.08 -				430WGTZ	- For PTO
41.350 FFDK, FFDRK	06.08 -			8950.40.00	KZIZ-6	- GBox: ZF Ecosplit 3 - For PTO
41.390 FFDC, FFDRK 39W	06.08 -			4028.10.00	400	- GBox: ZF Ecosplit 3
41.390 FFDC-TM, FFDRK-TM 39W	06.08 -				MFZ2/400X	- Vehicles with double disc clutch - This part number includes one clutch disc
41.430 FFDC, FFDRK 39W	10.07 -			4036.30.00	400 10	- GBox: ZF Ecosplit 3
41.430 FFDC-TM, FFDRK-TM 39W	10.07 -				400 WGTZ	- Vehicles with double disc clutch
41.430 FFDK, FFDRK 39W	10.07 -			8941.40.00	KZISZ-5	- GBox: ZF Ecosplit 3 - Vehicles with double disc clutch
19.440 FS-WW, FRS-WW, FLS-WW, FLRS-WW 72W, 06W, 71W, 03W	02.11 -	D 2676 LF 04		4300.90.102	430 10	- GBox: ZF Ecosplit 3
19.480 FS/M-WW, FRS/M-WW, FLS/M-WW, FLRS/M-WW 72W, 06W, 71W, 03W	02.11 -	D 2676 LF 02		4386.20.00	MFZ430	
		D 2676 LF 03		4386.30.00	430WGTZ	
		D 2676 LF 20		8916.40.00	KZIZ - 5	
21.440 FS, FLS 72W, 06W, 71W, 03W	10.07 -	D 2676 LF 31		4300.90.105	430 10	- GBox: ZF AS-Tronic
21.480 FS, FLS 72W, 06W, 71W, 03W	10.07 -			4386.20.00	MFZ430	- Use release fork with rollers
33.440 FDC-TM, FDRC-TM 26W	10.07 -			4386.30.00	430WGTZ	
40.440 FDAK-WW, FDARK-WW 58W	02.11 -			8939.40.00	KZISZ - 5	
40.440 FDAS-WW, FDARS-WW 58W	02.11 -			43461.30.00	430 10	- GBox: ZF Ecosplit 3
40.480 FDAK, FDARK 58W	06.08 -				430WGTZ	- For PTO
40.480 FDAS, FDARS 58W	06.08 -			8950.40.00	KZIZ-6	- GBox: ZF Ecosplit 3 - For PTO
				4028.10.00	400	- GBox: ZF Ecosplit 3
					MFZ2/400X	- Vehicles with double disc clutch - This part number includes one clutch disc
				4036.30.00	400 10	- GBox: ZF Ecosplit 3
					400 WGTZ	- Vehicles with double disc clutch
				8941.40.00	KZISZ-5	- GBox: ZF Ecosplit 3 - Vehicles with double disc clutch

Vehicle list



MAN

TGS

24.440 FNLLW/N 45S 24.440 FPLS, FPLRS 24S 26.440 FNLS, FNLLS, FNLRS, FPLS, FPLRS, FVLS 24S, 18S, 18W, 21S	10.07 -	D 2066 LF 25	4300.90.101	430 10	- Engine code: D2066LF36 EURO 4, D2066LF25 EURO 5 - GBox: ZF Ecosplit-3	
	10.07 -	D 2066 LF 36	4386.20.00	MFZ430		
	02.09 -	D 2066 LF 40	4386.30.00	430WGTZ		
		D 2066 LF 50	8916.40.00	KZIZ - 5		
		D 2066 LF 62	4300.90.102	430 10	- Engine code: D2066LF36 EURO 4, D2066LF25 EURO 5 - GBox: ZF Ecosplit-3	
			4386.20.00	MFZ430		
			4386.30.00	430WGTZ		
			8916.40.00	KZIZ - 5		
			4300.90.56	430 10	- Engine code: D2066LF36 EURO 4, D2066LF25 EURO 5 - GBox: ZF AS-Tronic - Use release fork with rollers	
		4319.20.00	MFZ430			
		4346.30.00	430WGTZ			
		8939.40.00	KZISZ - 5			
		4300.90.13	430 10	- Engine code: D2066LF36 EURO 4, D2066LF25 EURO 5 - GBox: ZF AS-Tronic - Use release fork with cam		
		4319.20.00	MFZ430			
		4346.30.00	430WGTZ			
		8919.40.00	KZISZ - 5			
		43461.30.00	430 10	- Engine code: D2066LF36 EURO 4, D2066LF25 EURO 5 - GBox: ZF Ecosplit-3 - For PTO		
		430WGTZ				
		8950.40.00	KZIZ-6	- Engine code: D2066LF36 EURO 4, D2066LF25 EURO 5 - GBox: ZF Ecosplit-3 - For PTO		
		4028.10.00	400	- Engine code: D2066LF36 EURO 4, D2066LF25 EURO 5 - GBox: ZF Ecosplit-3 - Vehicles with double disc clutch - This part number includes one clutch disc		
		400WGTZ				
		4036.30.00	400 10	- Engine code: D2066LF36 EURO 4, D2066LF25 EURO 5 - GBox: ZF Ecosplit 3 - Vehicles with double disc clutch		
		400 WGTZ				
		8941.40.00	KZISZ-5	- Engine code: D2066LF36 EURO 4, D2066LF25 EURO 5 - GBox: ZF Ecosplit-3 - Vehicles with double disc clutch		
32.360 FFDRC 49S 33.320 FDAC, FDALC 82S,56S 33.320 FDAK, FDALK 82S, 56S 33.320 FDAS, FDALS 82S, 56S 33.320 FDC, FDLC, FDLRC, FDRC 78W, 26S 33.320 FDK, FDLK 26S 33.320 FDLs, FDS 26S, 30S 35.320 FFDK 96S 35.320 FFDK, FFDHLK 59S, 93S 35.360 FFDK 96S,96W 35.400 FFDK 96S, 60W 35.400 FFDK, FFDHLK 59S, 96S, 93S 41.320 FFDK 96S 41.320 FFDC 39S 41.320 FFDK 39S 41.320 FFD-TM 39S	08.08 -	D 2066 LF 37	4300.90.52	430 10	- GBox: ZF Ecosplit-3	
	06.08 -	D 2066 LF 38	4319.20.00	MFZ430		
	06.08 -	D 2066 LF 39	4346.30.00	430WGTZ		
	06.08 -	D 2066 LF 41	8916.40.00	KZIZ - 5		
	06.08 -	D 2066 LF 42	4300.90.56	430 10	- Use release fork with rollers	
	06.08 -	D 2066 LF 43	4319.20.00	MFZ430		
	06.08 -	D 2066 LF 48	4346.30.00	430WGTZ		
	06.08 -	D 2066 LF 49	8939.40.00	KZISZ - 5		
	06.08 -	D 2066 LF 52	4300.90.13	430 10	- Use release fork with cam	
	06.08 -	D 2066 LF 61	4319.20.00	MFZ430		
	06.08 -	D 2066 LF 63	4346.30.00	430WGTZ		
	06.08 -	D 2066 LF 64	8919.40.00	KZISZ - 5		
	06.08 -	D 2066 LF 67	43461.30.00	430 10	- GBox: ZF Ecosplit-3 - For PTO	
	06.08 -	D 2066 LF 68	430WGTZ			
			8950.40.00	KZIZ-6	- GBox: ZF Ecosplit-3 - For PTO	
			4028.10.00	400	- GBox: ZF Ecosplit-3 - Vehicles with double disc clutch - This part number includes one clutch disc	
			400WGTZ			
		4036.30.00	400 10	- GBox: ZF Ecosplit-3 - Vehicles with double disc clutch		
		400 WGTZ				
		8941.40.00	KZISZ-5	- GBox: ZF Ecosplit-3 - Vehicles with double disc clutch		

Vehicle list



MAN

TGX

18.360 FHLC 22X	10.07 -	D 2066 LF 26	4300.90.52	430 10	- GBox: ZF Ecosplit 3
18.360 FHLS, FHLS/M 22X	10.07 -	D 2066 LF 27	4319.20.00	MFZ430	
18.360 FLC, FLRC, FLLC, FLLRC, FLLW, FLLW/N 06X, 15X, 10X	10.07 -	D 2066 LF 28	4346.30.00	430WGTZ	
18.360 FLS, FLS/M, FLRS, FLRS/N, FLLS, FLLS/N, FLLRS, FLLRS/N 06X, 15X, 13X, 10X	10.07 -	D 2066 LF 37	8916.40.00	KZIZ - 5	
18.360 FLS, FLS/M, FLRS, FLRS/N, FLLS, FLLS/N, FLLRS, FLLRS/N 06X, 15X, 13X, 10X	10.07 -	D 2066 LF 38	4300.90.56	430 10	- GBox: ZF AS-Tronic
18.400 FHLC 22X	10.07 -	D 2066 LF 41	4319.20.00	MFZ430	- Use release fork with rollers
18.400 FHLS, FHLS/M 22X	10.07 -	D 2066 LF 42	4346.30.00	430WGTZ	
18.400 FLC, FLRC, FLLC, FLLRC, FLLW, FLLW/N 06X, 15X, 10X	10.07 -	D 2066 LF 43	8939.40.00	KZISZ - 5	
18.400 FLS, FLS/M, FLRS, FLRS/N, FLLS, FLLS/N, FLLRS, FLLRS/N 05X, 06X, 13X, 10X	10.07 -	D 2066 LF 51	4300.90.13	430 10	- GBox: ZF AS-Tronic
24.360 FNLLW/N 45X	10.07 -	D 2066 LF 52	4319.20.00	MFZ430	- Use release fork with cam
24.360 FPLS, FPLRS 45X, 24X	10.07 -	D 2066 LF 61	4346.30.00	430WGTZ	
24.400 FNLLW/N 45X	10.07 -	D 2066 LF 67	8919.40.00	KZISZ - 5	
24.400 FPLS, FPLRS 45X, 24X	10.07 -		43461.30.00	430 10 430WGTZ	- GBox: ZF Ecosplit 3 - For PTO
26.320 FNLS, FNLLS, FNLRS 18X, 21X	10.07 -		8950.40.00	KZIZ-6	- GBox: ZF Ecosplit 3 - For PTO
26.360 FDC, FDC/M, FDLC, FDRC, FDRC/M, FDLRC, FNHLC 30X, 26X, 35X	10.07 -		4028.10.00	400 MFZ2/400X	- GBox: ZF Ecosplit 3 - Vehicles with double disc clutch - This part number includes one clutch disc
26.360 FDHLC 70X	10.07 -		4036.30.00	400 10 400 WGTZ	- GBox: ZF Ecosplit-3 - Vehicles with double disc clutch
26.360 FDHLS 70X	10.07 -		8941.40.00	KZISZ-5	- GBox: ZF Ecosplit 3 - Vehicles with double disc clutch
26.360 FDLRS, FDLS, FDRS, FDS, FNHLS, FPHLS, FVHLS 30X, 42X, 26X, 35X	10.07 -				
26.360 FNHLC 35X	10.07 -				
26.360 FNHLS 35X	12.07 -				
26.360 FNLC, FNLRC, FNLLC, FNLLRC, FNLLW 18X, 21X	10.07 -				
26.360 FNLS, FNLLS, FNLRS, FNLLRS, FPLS, FPLRS, FVLS 18X, 21X, 24X	10.07 -				
26.360 FVHLS 42X	10.07 -				
26.400 FDC, FDC/M, FDLC, FDRC, FDRC/M, FDLRC, FNHLC 30X, 26X, 35X	10.07 -				
26.400 FDHLC 70X	05.08 -				
26.400 FDHLS 70X	05.08 -				
26.400 FDLRS, FDLS, FDRS, FDS, FNHLS, FPHLS, FVHLS 30X, 26X	07.08 -				
26.400 FNHLC 35X	12.07 -				
26.400 FNHLS 35X	12.07 -				
26.400 FNLC, FNLRC, FNLLC, FNLLRC, FNLLW 18X, 21X	12.07 -				
26.400 FNLS, FNLLS, FNLRS, FNLLRS, FPLS, FPLRS, FVLS 18X, 21X, 24X	10.07 -				
26.400 FNLS, FNLLS, FNLRS, FNLLRS, FPLS, FPLRS, FVLS 18X, 21X, 24X	10.07 -				
26.400 FPHLS 42X	10.07 -				
26.400 FVHLS 42X	10.07 -				
28.360 FNLC 89X	05.08 -				
28.360 FNLS 89X	05.08 -				
28.400 FNLC 89X	10.07 -				
28.400 FNLS 89X	10.07 -				

Vehicle list



MAN

TGX

32.440 FDC, FDL, FDLRC, FDRC 30X, 26X	10.07 -	D 2066 LF 25	4300.90.52	430 10	- GBox: ZF Ecosplit 3
33.360 FDC, FDC/M, FDL, FDLRC 30X, 26X	10.07 -	D 2066 LF 26	4319.20.00	MFZ430	
33.360 FDS, FDS/M, FDL, FDL/M 30X, 26X	10.07 -	D 2066 LF 27	4346.30.00	430WGTZ	
33.400 FDC, FDC/M, FDL, FDLRC, FDRC	10.07 -	D 2066 LF 36	8916.40.00	KZIZ - 5	
33.400 FDS, FDS/M, FDL, FDL/M 30X, 26X	10.07 -	D 2066 LF 37	4300.90.56	430 10	- GBox: ZF AS-Tronic
33.680 FDL 79X	10.07 -	D 2066 LF 38	4319.20.00	MFZ430	- Use release fork with cam
33.680 FDL 79X	10.07 -	D 2066 LF 40	4346.30.00	430WGTZ	
35.360 FDNLC 92X	06.08 -	D 2066 LF 41	8939.40.00	KZISZ - 5	
35.400 FDNLC 92X	06.08 -	D 2066 LF 42	4300.90.13	430 10	- GBox: ZF AS-Tronic
35.440 FDNLC 92X	06.08 -	D 2066 LF 61	4319.20.00	MFZ430	- Use release fork with cam
35.480 FDNLC 92X	06.08 -	D 2066 LF 67	4346.30.00	430WGTZ	
35.540 FDNLC 92X	06.08 -	D 2676 LF 05	8919.40.00	KZISZ - 5	
		D 2676 LF 06	43461.30.00	430 10	- GBox: ZF Ecosplit 3
		D 2676 LF 07	8950.40.00	430WGTZ	- For PTO
		D 2676 LF 13	4028.10.00	KZIZ-6	- GBox: ZF Ecosplit 3
		D 2676 LF 14	4036.30.00	400	- For PTO
		D 2676 LF 25	8941.40.00	430WGTZ	- GBox: ZF Ecosplit 3
		D 2868 LF02	4028.10.00	400	- Vehicles with double disc clutch
		D 2868 LF05	4036.30.00	400 10	- This part number includes one clutch disc
			8941.40.00	400 WGTZ	- Vehicles with double disc clutch
18.440 FHLC 22X	10.07 -	D 2066 LF 25	4300.90.101	430 10	- GBox: ZF Ecosplit 3
18.440 FHLS, FHLS/M 22X	10.07 -	D 2066 LF 36	4386.20.00	MFZ430	
18.440 FLC, FLRC, FLLC, FLLRC, FLLW, FLLW/N 06X, 15X, 10X	10.07 -	D 2066 LF 40	4386.30.00	430WGTZ	
18.440 FLS, FLS/M, FLRS, FLRS/M, FLLS, FLLS/N, FLLRS, FLLRS/ 05X, 06X, 13X, 10X	10.07 -	D 2066 LF 57	8916.40.00	KZIZ - 5	
24.440 FNLLW/N 45X	10.07 -	D 2676 LF 22	4300.90.102	430 10	- GBox: ZF Ecosplit 3
24.440 FPLS, FPLRS 45X, 24X	10.07 -	D 2676 LF 26	4386.20.00	MFZ430	
26.440 FDC, FDC/M, FDL, FDRC, FDRC/M, FDLRC, FNHLC 30X, 26X, 35X	07.08 -		4386.30.00	430WGTZ	
26.440 FDHLC 70X	09.07 -		8916.40.00	KZIZ - 5	
26.440 FDHLS 70X	09.07 -		4300.90.56	430 10	- GBox: AS-Tronic
26.440 FDLRS, FDL, FDRS, FDS, FNHLS, FPHLS, FVHLS 30X, 42X, 26X, 35X	12.07 -		4319.20.00	MFZ430	- Use release fork with rollers
26.440 FNHLC 35X	12.07 -		4346.30.00	430WGTZ	
26.440 FNHLS 35X	12.07 -		8939.40.00	KZISZ - 5	
26.440 FNLC, FNLC, FNLLC, FNLLRC, FNLLW 18X, 21X	10.07 -		4300.90.13	430 10	- GBox: AS-Tronic
26.440 FNLS, FNLS, FNLLS, FNLLRS, FNLLRS, FPLS, FPLRS, FVLS 18X, 21X, 24X	10.07 -		4319.20.00	MFZ430	- Use release fork with cam
	10.07 -		4346.30.00	430WGTZ	
	10.07 -		8919.40.00	KZISZ - 5	
	10.12 -		43461.30.00	430 10	- GBox: ZF Ecosplit 3
26.440 FPHLS 42X	05.08 -		8950.40.00	430WGTZ	- For PTO
26.440 FVHLS 42X	05.08 -		4028.10.00	400	- GBox: ZF Ecosplit 3
28.440 FNLC 89X	10.07 -		4036.30.00	400 10	- Vehicles with double disc clutch
28.440 FNLS 89X	10.07 -		8941.40.00	400 WGTZ	- Vehicles with double disc clutch
33.440 FDC, FDC/M, FDL, FDLRC, FDRC 30X, 26X	10.07 -				
33.440 FDS, FDS/M, FDL, FDL/M 30X, 26X	10.07 -				

Vehicle list



MAN

TGX

18.440 FHLS, FHLS/M 22X	10.12 -	D 2676 LF 05	4300.90.102	430 10	- GBox: ZF Ecosplit 3
18.440 FLC, FLLC, FLLRC, FLLW, FLRC 06X, 15X, 10X	10.07 -	D 2676 LF 06	4386.20.00	MFZ430	
18.440 FLS, FLSS, FLSS/N, FLRS, FLRS/N, FLLRS, FLLS 05X, 06X, 13X, 10X	10.07 -	D 2676 LF 07	4386.30.00	430WGTZ	
18.480 FHLC 22X	10.07 -	D 2676 LF 13	8916.40.00	KZIZ - 5	
18.480 FHLS, FHLS/M 22X	10.07 -	D 2676 LF 14	4300.90.105	430 10	- GBox: ZF AS-Tronic
18.480 FLC, FLRC, FLLC, FLLRC, FLLW, FLLW/N 06X, 15X, 10X	10.07 -	D 2676 LF 21	4386.20.00	MFZ430	- Use release fork with rollers
18.480 FLS, FLS/M, FLRS, FLRS/N, FLLS, FLLS/N, FLLRS, FLLRS/N 05X, 06X, 13X, 10X	10.07 -	D 2676 LF 22	4386.30.00	430WGTZ	
18.540 FHLC 22X	10.07 -	D 2676 LF 25	8939.40.00	KZISZ - 5	
18.540 FHLS, FHLS/M 22X	10.07 -	D 2676 LF 26	8919.40.00	KZISZ - 5	- GBox: ZF AS-Tronic - Use release fork with cam
18.540 FLC, FLRC, FLLC, FLLRC, FLLW, FLLW/N 06X, 15X, 10X	10.07 -		43461.30.00	430 10 430WGTZ	- GBox: ZF Ecosplit 3 - For PTO
18.540 FLS, FLS/M, FLRS, FLRS/N, FLLS, FLLS/N, FLLRS, FLLRS/N 05X, 06X, 13X, 10X	10.07 -		8950.40.00	KZIZ-6	- GBox: ZF Ecosplit 3 - For PTO
24.440 FNLLW/N 45X	10.12 -		4028.10.00	400 MFZ2/400X	- GBox: ZF Ecosplit 3 - Vehicles with double disc clutch - This part number includes one clutch disc
24.440 FPLS, FPLRS 24X	10.07 -		4036.30.00	400 10 400 WGTZ	- GBox: ZF Ecosplit-3 - Vehicles with double disc clutch
24.480 FNLLW/N 45X	10.07 -		8941.40.00	KZISZ-5	- GBox: ZF Ecosplit 3 - Vehicles with double disc clutch
24.480 FPLS, FPLRS 45X, 24X	10.07 -				
24.540 FNLLW/N 45X	02.09 -				
24.540 FPLS, FPLRS 45X, 24X	10.07 -				
26.440 FDC, FDC/M, FDLC, FDRC, FDRC/M, FDLRC, FNHLC 30X, 26X	10.12 -				
26.440 FDK, FDLK	01.14 -				
26.440 FDLRS, FDLS, FDRS, FDS, FNHLS, FPHLS, FVHLS 30X, 26X	10.12 -				
26.440 FNLC, FNLRC, FNLLC, FNLLRC, FNLLW 18X, 21X	10.12 -				
26.440 FNLS, FNLLS, FNLRs, FNLLRS, FPLS, FPLRS, FVLS 18X, 21X, 24X	10.12 -				
26.440 FPLRS 24X	07.08 -				
26.480 FDC, FDC/M, FDLC, FDRC, FDRC/M, FDLRC, FNHLC 30X, 26X, 35X	07.08 -				
26.480 FDHLC 70X	09.07 -				
26.480 FDHLS 70X	10.07 -				

Vehicle list

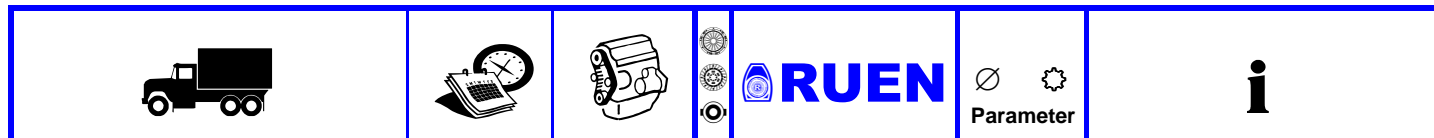

MAN

TGX

26.480 FDLRS, FDLS, FDRS, FDS, FNHLS, FPHLS, FVHLS 30X, 42X, 26X, 35X	12.07 -	D 2676 440	4300.90.102	430 10	- GBox: ZF Ecosplit 3
26.480 FNHLC 35X	12.07 -	D 2676 LF 05	4386.20.00	MFZ430	
26.480 FNHLS 35X	12.07 -	D 2676 LF 06	4386.30.00	430WGTZ	
26.480 FNLC, FNLRC, FNLLC, FNLLRC, FNLLW 18X, 21X	10.07 -	D 2676 LF 07	8916.40.00	KZIZ - 5	
26.480 FNLS, FNLLS, FNLRS, FNLLRS, FPLS, FPLRS, FVLS 18X, 21X, 24X	10.07 -	D 2676 LF 13	4300.90.105	430 10	- GBox: ZF AS-Tronic
	10.07 -	D 2676 LF 14	4386.20.00	MFZ430	- Use release fork with rollers
	10.07 -	D 2676 LF 16	4386.30.00	430WGTZ	
	10.07 -	D 2676 LF 21	8939.40.00	KZISZ - 5	
	10.07 -	D 2676 LF 25	8919.40.00	KZISZ - 5	- GBox: ZF AS-Tronic
	10.07 -	D 2676 LF 26			- Use release fork with cam
26.480 FPHLS 42X	05.08 -		43461.30.00	430 10	- GBox: ZF Ecosplit 3
26.480 FVHLS 42X	05.08 -			430WGTZ	- For PTO
26.540 FDC, FDC/M, FDLRC, FDLRC, FDLRC/M, FDLRC 30X, 26X	02.09 -		8950.40.00	KZIZ-6	- GBox: ZF Ecosplit 3
26.540 FDLRS, FDLS, FDRS, FDS, FVHLS 30X, 42X, 26X	02.09 -		4028.10.00	400	- GBox: ZF Ecosplit 3
26.540 FDLRS, FDLS, FDRS, FDS, FVHLS 42X	10.12 -			MFZ2/400X	- Vehicles with double disc clutch
26.540 FNLC, FNLRC, FNLLC, FNLLRC, FNLLW 18X, 21X	10.07 -		4036.30.00	400 10	- GBox: ZF Ecosplit-3
26.540 FNLS, FNLRS, FNLLS, FPLS, FPLRS, FVLS 18X, 21X, 24X	10.07 -			400 WGTZ	- Vehicles with double disc clutch
	10.07 -		8941.40.00	KZISZ-5	- GBox: ZF Ecosplit 3
	10.07 -				- Vehicles with double disc clutch
28.440 FNLC 89X	10.12 -				
28.440 FNLS 89X	10.12 -				
28.480 FNLC 89X	10.12 -				
28.480 FNLS 89X	10.07 -				
28.540 FNLC 89X	10.07 -				
28.540 FNLS 89X	02.09 -				
29.440	01.09 -				
33.440 FDC, FDC/M, FDLRC, FDLRC, FDLRC 30X, 26X	09.09 -				
33.440 FDS, FDS/M, FDLS, FDLS/M 30X, 26X	10.12 -				
33.480 FDC, FDC/M, FDLRC, FDLRC, FDLRC 30X, 26X	10.07 -				
33.480 FDS, FDS/M, FDLS, FDLS/M 30X, 26X	10.07 -				
33.540 FDC, FDC/M, FDLRC, FDLRC, FDLRC 30X, 26X	10.07 -				
33.540 FDS, FDS/M, FDLS, FDLS/M 30X, 26X	10.07 -				
41.540 FVDS, FVDLS 87X, 86X	06.08 -				

Vehicle list

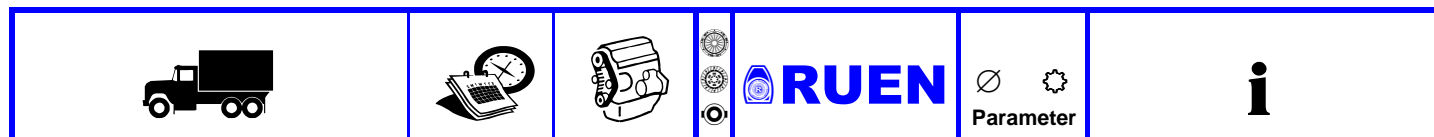

MAN







TGX

26.480 FDK, FDLK 27.440 FNS 88X 28.440 FDS 28X, 27X 33.440 FDK, FDLK 33.480 FDK, FDLK 35.440 FDNLC 92X	12.07 - 10.12 - 10.12 - 01.14 - 01.14 - 06.08 -	D 2676 LF 05 D 2676 LF 07 D 2676 LF 10 D 2676 LF 14 D 2676 LF 16 D 2676 LF 25 D 2676 LF 26 D 2676 LF 28	4300.90.102 4386.20.00 4386.30.00 8916.40.00	430 10 MFZ430 430WGTZ KZIZ - 5	- GBox: ZF Ecosplit 3
			4300.90.105 4386.20.00 4386.30.00 8939.40.00	430 10 MFZ430 430WGTZ KZISZ - 5	- GBox: ZF AS-Tronic - Use release fork with rollers
			43461.30.00	430 10 430WGTZ	- GBox: ZF Ecosplit 3 - For PTO
			8950.40.00	KZIZ-6	- GBox: ZF Ecosplit 3 - For PTO
			4028.10.00	400 MFZ2/400X	- GBox: ZF Ecosplit 3 - Vehicles with double disc clutch - This part number includes one clutch disc
			4036.30.00	400 10 400 WGTZ	- GBox: ZF Ecosplit-3 - Vehicles with double disc clutch
			8941.40.00	KZISZ-5	- GBox: ZF Ecosplit 3 - Vehicles with double disc clutch
18.520 FLS 18.560 FLS 18.640 FLS 41.640 FLS	09.14 - 09.14 - 09.16 - 09.14 -	D 3876 LF01 D 3876 LF02 D 3876 LF03	8939.40.00	KZISZ - 5	- Engine code: D3876 LF - GBox: AS Tronic
18.680 FLS 78X 41.680 FVDS, FVDLS 95X, 94X	10.07 - 10.07 -	D 2868 LF02 D 2868 LF03 D 2868 LF05 D 2868 LF06	4300.90.202 4387.20.00 4387.30.00 8939.40.00	430 10 MFZ430 430WGTZ KZISZ - 5	- GBox: ZF AS-Tronic

MAN-BÜSSING























400-SERIE 400 L 1 400-SERIE 415 L 1 H,HA,F 400-SERIE 420 HOC 500-SERIE 520 L 1 H,HA,F 600-SERIE 626 F,H,HA			2802.20.00	280 G280	
400-SERIE 450 HALF 600-SERIE 635 FM			3133.20.00	310 G310	
500-SERIE 515 L 1 600-SERIE 620 L 1 600-SERIE 630 L 1 A 700-SERIE 745 L 1 700-SERIE 750 L 1,L 13 Büssing MK,25,26			3552.30.00	350 10 350	
700-SERIE 770 L 1 700-SERIE 780 H,HA 1000-SERIE 1070 L 1,A,F 1000-SERIE 1080 H 1000-SERIE 1580 2000-SERIE 2170 L 1 D			3521.20.00 3588.30.00 3516.30.00	350 GF350KR 350 10 350GSZ 350 10 350WGSZ	- To model year: 04/1972 - From model year: 05/1972
1000-SERIE 1580 DF,DH 2000-SERIE 2180 DH,DHA			3521.20.00 3514.30.00	350 GF350KR 350 10 350WGSZ	
1000-SERIE 1580 FN MA			3588.30.00 3516.30.00 8505.40.00	350 10 350GSZ 350 10 350WGSZ KZI - 4,5	- To model year: 04/1972 - From model year: 05/1972

Vehicle list







					
---	---	---	--	---	---

MAN

































MAN-BÜSSING

BS 13 L 15L			 3814.20.00	380 G380KR	- Engine code: U10D
			 3899.30.00	380 10 380GSZ	- Engine code: U10D
Burglöwe K,L,S 10 126M36,T Burglöwe L 10 126M43,50 Burglöwe U BS 11,L09 Burglöwe U,UK,US,UMK,UMW Büssing 8 RU 5 Büssing 11 RU 5HR Büssing 12 RU 5HR Büssing 4000 T,K Büssing 4500 T,U Büssing LS 5 TU Büssing LU,TU 5,10 Büssing LU,TU,LS,OLU 55			 3133.20.00	310 G310	
			 3108.30.00	310 310GSZ	
Burglöwe L09 110 M36			 3131.20.00	310 G310	
			 3108.30.00	310 310GSZ	
Büssing Mowag SW II			 3133.20.00	310 G310	
			 3155.30.00	310 10 310Z	
5...					
5.126 F			 3126.20.00	310 GF310X	
6...					
6.115 H			 2802.20.00	280 G280	
			 2827.30.00	280 10 280Z	
6.126 H			 3126.20.00	310 GF310X	
			 3155.30.00	310 10 310Z	
7...					
7.126 F 7.126 H 7.136 F			 2801.20.00	280 G280	
			 2827.30.00	280 10 280Z	
			 3126.20.00	310 GF310X	
			 3155.30.00	310 10 310Z	
7.136 H			 3126.20.00	310 GF310X	
			 3155.30.00	310 10 310Z	
8...					
8.126 F			 3126.20.00	310 GF310X	
8.126 H			 3126.20.00	310 GF310X	
			 3155.30.00	310 10 310Z	

Vehicle list

					
---	---	---	--	---	---



























MAN

8...					
8.156 F				3521.20.00	350 GF350KR
8.160 F				3516.30.00	350 10 350WGSZ
8.186 FW				8505.40.00	KZI - 4,5
8.156 H				2802.20.00	280 G280
				2827.30.00	280 10 280Z
				6905.40.00	KZIS - 3
8.192				3539.20.00	350 GF350
				3575.30.00	350 10 350WGSZ
				3510.30.00	350 10 350W2GSZ
				8533.40.00	KZI - 4,5
9...					
9.126 H				3126.20.00	310 GF310X
				3155.30.00	310 10 310Z
9.156 H,F 9.168 FL 9.186 F,H,HKA 9.192 FL				3521.20.00	350 GF350KR
				3516.30.00	350 10 350WGSZ
				8505.40.00	KZI - 4,5
9.160 HAK				3521.20.00	350 GF350KR
				3516.30.00	350 10 350WGSZ
9.192 HA				3563.20.00	350 GMF350
				3565.20.00	350 GMF350
				3575.30.00	350 10 350WGSZ
				3510.30.00	350 10 350W2GSZ
				8533.40.00	KZI - 4,5
10...					
10.126 H,HA 10.136 H,HA				3126.20.00	310 GF310X
				3155.30.00	310 10 310Z
10.150 10.152	01.87 - 12.91 01.87 - 12.92			3500.90.04	350 10
				3573.20.00	MF350
				3587.30.00	350GSZ
10.210				6905.40.00	KZIS - 3
				3563.20.00	350 GMF350
				3565.20.00	350 GMF350
				3510.30.00	350 10 350W2GSZ
				3575.30.00	350 10 350WGSZ
				8533.40.00	KZI - 4,5







Vehicle list

					
---	---	---	--	---	---































MAN

10...					
10.212	12.65 -			3861.30.00	380 10 380W2GSZ
10.215				8505.40.00	KZI - 4,5
10.230 FL				8505.40.00	KZI - 4,5
10.212	- 11.65			8505.40.00	KZI - 4,5
11...					
11.136 H,HA,HK,HS,HAK				3126.20.00	310 GF310X
				3155.30.00	310 10 310Z
11.136 U				3126.20.00	310 GF310X
				3155.30.00	310 10 310Z
				6905.40.00	KZIS - 3
11.168				3563.20.00	350 GMF350
				3565.20.00	350 GMF350
				3575.30.00	350 10 350WGSZ
				3510.30.00	350 10 350W2GSZ
				8533.40.00	KZI - 4,5
11.190 11.220 11.230				3573.20.00	350 MF350
				3596.30.00	350 10 350WGSZ
				6905.40.00	KZIS - 3
11.192 HA				3539.20.00	350 GF350
				3575.30.00	350 10 350WGSZ
				3510.30.00	350 10 350W2GSZ
				8533.40.00	KZI - 4,5
13...					
13.136 H,HA				3126.20.00	310 GF310X
				3155.30.00	310 10 310Z
13.136 U				3126.20.00	310 GF310X
				3155.30.00	310 10 310Z
				6905.40.00	KZIS - 3

Vehicle list

					
---	---	---	--	---	---

































MAN

13...					
13.168		3563.20.00	350 GMF350	- Engine code: D2555M,MF,MFX	
		3565.20.00	350 GMF350	- Engine code: D2555M,MF,MFX	
		3575.30.00	350 10 350WGSZ	- Engine code: D2555M,MF,MFX,D2565MF	
		3510.30.00	350 10 350W2GSZ	- Engine code: D2555M,MF,MFX,D2565MF	
		8533.40.00	KZI - 4,5	- Engine code: D2555M,MF,MFX	
		3539.20.00	350 GF350	- Engine code: D2565MF	
		3804.20.00	380 G380KR	- Engine code: D2855BYUL	
		3835.20.00	380 GF380	- Engine code: D2538M	
		3857.30.00	380 10 380W2GSZ	- Engine code: D2538M	
		8505.40.00	KZI - 4,5	- Engine code: D2538M	
13.192		3539.20.00	350 GF350		
		3563.20.00	350 GMF350		
		3575.30.00	350 10 350WGSZ		
		3510.30.00	350 10 350W2GSZ		
		8533.40.00	KZI - 4,5		
13.192 F,H,HA		3521.20.00	350 GF350KR		
		3516.30.00	350 10 350WGSZ		
		8505.40.00	KZI - 4,5		
13.192 U,UL		3539.20.00	350 GF350		
		3575.30.00	350 10 350WGSZ		
		3510.30.00	350 10 350W2GSZ		
		8533.40.00	KZI - 4,5		
13.212 13.215 H,F 13.230 H,F		3861.30.00	380 10 380W2GSZ		
		8505.40.00	KZI - 4,5		
13.250 F 13.256 F 13.275 F 13.304 F		4222.20.00	420 GF420KR		
		4283.30.00	420 10 420WGSZ		
		8505.40.00	KZI - 4,5		
13.304 DFR		4222.20.00	420 GF420KR		
14...					
14.136		3168.20.00	310 MF310		
		3113.30.00	310 10 310GSBL		
		6905.40.00	KZIS - 3		

Vehicle list

					
---	---	---	--	---	---

MAN

14...					
14.168		D2555MF D2565MF	 3563.20.00	350 GMF350	
			 3565.20.00	350 GMF350	
			 3575.30.00	350 10 350WGSZ	
			 3510.30.00	350 10 350W2GSZ	- Engine code: D2555MF,MXF
			 8533.40.00	KZI - 4,5	
			 3539.20.00	350 GF350	- Engine code: D2565MF
14.170			 3573.20.00	350 MF350	- GBox: ZF-S6-36
			 3563.30.00	350 10 350GSZ	- GBox: ZF-S6-36
			 6905.40.00	KZIS - 3	- GBox: ZF-S6-36
			 3877.20.00	380 GMF380	- GBox: ZF-S6-65
			 3857.30.00	380 10 380W2GSZ	- GBox: ZF-S6-65
			 8505.40.00	KZI - 4,5	- GBox: ZF-S6-65
14.192 903			 3539.20.00	350 GF350	
			 3563.20.00	350 GMF350	
			 3575.30.00	350 10 350WGSZ	
			 3510.30.00	350 10 350W2GSZ	
			 8533.40.00	KZI - 4,5	
14.192			 3877.20.00	380 GMF380	
			 3857.30.00	380 10 380W2GSZ	
			 8505.40.00	KZI - 4,5	
14.192 F,H			 3539.20.00	350 GF350	
			 3575.30.00	350 10 350WGSZ	
			 3510.30.00	350 10 350W2GSZ	
			 8533.40.00	KZI - 4,5	
14.200			 3835.20.00	380 GF380	
			 3857.30.00	380 10 380W2GSZ	
			 8505.40.00	KZI - 4,5	
14.220	01.83 -		 3835.20.00	380 GF380	
			 3857.30.00	380 10 380W2GSZ	
			 4235.20.00	420 GF420KR	
			 4250.30.00	420 10 420WGSZ	
			 8505.40.00	KZI - 4,5	
14.285 DFR			 4222.20.00	420 GF420KR	

Vehicle list









MAN





























15...

15.136 H,HA		3126.20.00	310 GF310X	
		3155.30.00	310 10 310Z	
15.168 15.192		3530.30.00	350 10 350GSZ	
15.168		3563.20.00	350 GMF350	- Engine code: D2568,D2555M,MF,MXF
		3565.20.00	350 GMF350	- Engine code: D2568,D2555M,MF,MXF
		3575.30.00	350 10 350WGSZ	- Engine code: D2568,D2555M,MF,MXF
		3510.30.00	350 10 350W2GSZ	- Engine code: D2568,D2555M,MF,MXF
		8533.40.00	KZI - 4,5	- Engine code: D2568,D2555M,MF,MXF
		3835.20.00	380 GF380	- Engine code: D2538M
		3857.20.00	380 G380KR	- Engine code: D2538M
15.168 FM,HOC		3521.20.00	350 GF350KR	
		3516.30.00	350 10 350WGSZ	
		3835.20.00	380 GF380	- Engine code: D2238M
15.192		3857.30.00	380 10 380W2GSZ	- Engine code: D2238M
		8505.40.00	KZI - 4,5	- Engine code: D2238M
		3539.20.00	350 GF350	- Engine code: D2565M
		3563.20.00	350 GMF350	- Engine code: D2565M - Engine code: D2568
		3575.30.00	350 10 350WGSZ	- Engine code: D2565M - Engine code: D2568
		3510.30.00	350 10 350W2GSZ	- Engine code: D2565M - Engine code: D2568
		8533.40.00	KZI - 4,5	- Engine code: D2565M - Engine code: D2568
		3565.20.00	350 GMF350	- Engine code: D2568
		3804.20.00	380 G380KR	- Engine code: D2855BYUL
	15.192 F,H,HA		3521.20.00	350 GF350KR
		3516.30.00	350 10 350WGSZ	
		8505.40.00	KZI - 4,5	
15.200 15.216		3835.20.00	380 GF380	
		3857.30.00	380 10 380W2GSZ	
		8505.40.00	KZI - 4,5	
15.212 15.215 HD		3861.30.00	380 10 380W2GSZ	
		8505.40.00	KZI - 4,5	







Vehicle list

					
---	---	---	--	---	---

MAN































15...					
15.220	01.83 -			3835.20.00	380 GF380
15.240	01.83 -			3857.30.00	380 10 380W2GSZ
				4235.20.00	420 GF420KR
				4250.30.00	420 10 420WGSZ
				8505.40.00	KZI - 4,5
15.240		D2238M		3835.20.00	380 GF380
				3857.30.00	380 10 380W2GSZ
				8505.40.00	KZI - 4,5
16...					
16.132 FKO				3539.20.00	350 GF350
				3575.30.00	350 10 350WGSZ
				3510.30.00	350 10 350W2GSZ
				8533.40.00	KZI - 4,5
16.136				3168.20.00	310 MF310
				3113.30.00	310 10 310GSBL
				6905.40.00	KZIS - 3
16.168				3530.30.00	350 10 350GSZ
16.192					
16.168		D2555MF MF MXF		3565.20.00	350 GMF350
				3575.30.00	350 10 350WGSZ
				3510.30.00	350 10 350W2GSZ
				8533.40.00	KZI - 4,5
16.168 FL				3520.20.00	350 GF350KR
16.186 FN				3516.30.00	350 10 350WGSZ
				8505.40.00	KZI - 4,5
16.170				3573.20.00	350 MF350 - GBox: ZF-S6-36
				3563.30.00	350 10 350GSZ - GBox: ZF-S6-36
				6905.40.00	KZIS - 3 - GBox: ZF-S6-36
				3877.20.00	380 GMF380 - GBox: ZF-S6-65
				3857.30.00	380 10 380W2GSZ - GBox: ZF-S6-65
				8505.40.00	KZI - 4,5 - GBox: ZF-S6-65

Vehicle list







			 RUEN	 Parameter	
---	---	---	--	--	---

MAN





































16...

16.192		3539.20.00	350 GF350	- Engine code: D2565M
		3536.20.00	350 GF350K	- Engine code: D2565M
		3575.30.00	350 10 350WGSZ	- Engine code: D2565M
		3510.30.00	350 10 350W2GSZ	- Engine code: D2565M
		8533.40.00	KZI - 4,5	- Engine code: D2565M
		3877.20.00	380 GMF380	- Engine code: D0226MKF
		3857.30.00	380 10 380W2GSZ	- Engine code: D0226MKF
		8505.40.00	KZI - 4,5	- Engine code: D0226MKF
16.200 16.220		3835.20.00	380 GF380	
		3857.30.00	380 10 380W2GSZ	
		8505.40.00	KZI - 4,5	
16.215 H,F 16.216 16.230 H,F,FL 16.232 16.240 520		3861.30.00	380 10 380W2GSZ	
		8505.40.00	KZI - 4,5	
16.240		4235.20.00	420 GF420KR	
		4250.30.00	420 10 420WGSZ	
		8505.40.00	KZI - 4,5	- GBox: ZF
		8516.40.00	KZI - 4,5	- GBox: Fuller
		4224.20.00	420 GF420KR	
		3871.30.00	380 10 380/70GSZ	- For PTO
16.250 FN 16.256 H 16.275 FN 16.304 FN,FVS		4222.20.00	420 GF420KR	
		4283.30.00	420 10 420WGSZ	
		8505.40.00	KZI - 4,5	
16.256		3835.20.00	380 GF380	- Engine code: D2538M,MF
		3857.30.00	380 10 380W2GSZ	- Engine code: D2538M,MF
		8505.40.00	KZI - 4,5	- Engine code: D2538M,MF - Transmission type: ZF
		4235.20.00	420 GF420KR	
		4224.20.00	420 GF420KR	
		4250.30.00	420 10 420WGSZ	
		8516.40.00	KZI - 4,5	- Transmission type: Fuller
		4268.30.00	420 10 420GSZ	- Engine code: D2566MF







Vehicle list

					
---	---	---	--	---	---



























MAN

16...					
16.280			 4235.20.00	420 GF420KR	
			 4224.20.00	420 GF420KR	
			 4250.30.00	420 10 420WGSZ	
			 8505.40.00	KZI - 4,5	- Transmission type: ZF
			 8516.40.00	KZI - 4,5	- Transmission type: Fuller
16.281 16.291 504 16.321 16.331 504 16.361 504			 4200.90.03	420 10	
			 4244.20.00	GFX420KR	
			 4281.30.00	420WGVZ	
			 8516.40.00	KZI - 4,5	
			 3856.10.00	380 GF2/380	- This part number includes one clutch disc
			 3894.30.00	380 10 380GSZ	- Loose clutch disc
			 8505.40.00	KZI - 4,5	
			 3856.20.00	380 G380KR	
			 3896.30.00	380 10 380WGSZ	
			 3848.50.00	380 GF2/380	
			 4244.20.00	420 GFX420KR	- Engine code: D2866
			 4281.30.00	420 10 420WGVZ	- Engine code: D2866
			 8516.40.00	KZI - 4,5	- Engine code: D2866
	16.320			 4224.20.00	420 GF420KR
			 4235.20.00	420 GF420KR	- Engine code: D2538MT,D2530MF
			 4250.30.00	420 10 420WGSZ	- Engine code: D2538MT,D2530MF
			 8505.40.00	KZI - 4,5	- Engine code: D2538MT,D2530MF - Transmission type: ZF
			 8516.40.00	KZI - 4,5	- Engine code: D2538MT,D2530MF - Transmission type: Fuller
16.320 U,UL 902,908,909,918			 3889.10.00	380 GF2/380	
			 3870.30.00	380 10 380/210GSZ	- Loose clutch disc
			 8505.40.00	KZI - 4,5	
			 3892.20.00	380 GF2/380	
			 3871.30.00	380 10 380/70GSZ	
16.361			 4200.90.03	420 10	- Engine code: D2866
			 4244.20.00	GFX420KR	
			 4281.30.00	420WGVZ	
			 8516.40.00	KZI - 4,5	
16.462	01.85 -		 4300.90.05	430 10	- Engine code: D2840LF
			 4301.20.00	MFZ430	
			 4346.30.00	430WGTZ	
		 8916.40.00	KZIZ - 5		
		 4286.30.00	420 10 420WGTZ	- Engine code: D2840LF	

Vehicle list

					
---	---	---	--	---	---

MAN

16...						
16.242	01.85 -			4286.30.00	420 10 420WGTZ	- Engine code: D2866F
16.262	01.85 - 12.92					
16.272	01.90 -					
16.292	01.85 - 12.92					
16.302	01.90 - 12.92					
16.322	01.90 -					
16.332	01.85 - 12.92					
16.362	01.85 - 12.92					
16.372	01.90 -					
16.422	01.90 -					
17...						
17.170				3573.20.00	350 MF350	- GBox: ZF-S6-36
				3563.30.00	350 10 350GSZ	- GBox: ZF-S6-36
				6905.40.00	KZIS - 3	- GBox: ZF-S6-36
				3877.20.00	380 GMF380	- GBox: ZF-S6-65
				3857.30.00	380 10 380W2GSZ	- GBox: ZF-S6-65
				8505.40.00	KZI - 4,5	- GBox: ZF-S6-65
17.192				3877.20.00	380 GMF380	
				3857.30.00	380 10 380W2GSZ	
				8505.40.00	KZI - 4,5	
17.220				3835.20.00	380 GF380	
				3857.30.00	380 10 380W2GSZ	
				8505.40.00	KZI - 4,5	
17.240				3835.20.00	380 GF380	
				3857.30.00	380 10 380W2GSZ	
				8505.40.00	KZI - 4,5	
19...						
19.168				3530.30.00	350 10 350GSZ	
19.192						
19.168		D2555M		3563.20.00	350 GMF350	
				3565.20.00	350 GMF350	
				3575.30.00	350 10 350WGSZ	
				3510.30.00	350 10 350W2GSZ	
				8533.40.00	KZI - 4,5	
19.186 FN 19.192 FNM				3521.20.00	350 GF350KR	
				3516.30.00	350 10 350WGSZ	
				8505.40.00	KZI - 4,5	
19.186 H				3521.20.00	350 GF350KR	
				8505.40.00	KZI - 4,5	







Vehicle list







































MAN

19...						
19.192		D2565M		3563.20.00	350 GMF350	
				3539.20.00	350 GF350	
				3575.30.00	350 10 350WGSZ	
				3510.30.00	350 10 350W2GSZ	
				8533.40.00	KZI - 4,5	
19.215 19.230				3861.30.00	380 10 380W2GSZ	
				8505.40.00	KZI - 4,5	
19.220				3835.20.00	380 GF380	
				3857.30.00	380 10 380W2GSZ	
				8505.40.00	KZI - 4,5	
19.232				3835.20.00	380 GF380	
				3857.30.00	380 10 380W2GSZ	
				8505.40.00	KZI - 4,5	
19.240				3835.20.00	380 GF380	- Engine code: D2556MF
				3857.30.00	380 10 380W2GSZ	- Engine code: D2556MF
				8505.40.00	KZI - 4,5	- Engine code: D2556MF - Transmission type: ZF
				4235.20.00	420 GF420KR	
				4250.30.00	420 10 420WGSZ	
				8516.40.00	KZI - 4,5	- Transmission type: Fuller
19.250 DF 19.256 DH 19.275 D,DF 19.304 DF				4222.20.00	420 GF420KR	
				4283.30.00	420 10 420WGSZ	
				8505.40.00	KZI - 4,5	
19.256				4235.20.00	420 GF420KR	
				4250.30.00	420 10 420WGSZ	
				8505.40.00	KZI - 4,5	- Transmission type: ZF
				8516.40.00	KZI - 4,5	- Transmission type: Fuller
				3835.20.00	380 GF380	- Engine code: D2538M
				3857.30.00	380 10 380W2GSZ	- Engine code: D2538M
19.280				4235.20.00	420 GF420KR	
				4250.30.00	420 10 420WGSZ	
				8505.40.00	KZI - 4,5	- Transmission type: ZF
				8516.40.00	KZI - 4,5	- Transmission type: Fuller

Vehicle list

					
---	---	---	--	---	---

MAN

































19...						
19.281		D 2866		4200.90.03	420 10	
19.291				4244.20.00	GFX420KR	
19.321				4281.30.00	420WGVZ	
19.331				8516.40.00	KZI - 4,5	
19.361				3856.10.00	380	- This part number includes one clutch disc
					GF2/380	
				3894.30.00	380 10	
					380GSZ	
				8505.40.00	KZI - 4,5	
				3856.20.00	380	
					G380KR	
				3848.50.00	380	
					GF2/380	
				3896.30.00	380 10	
					380WGSZ	
19.320				4235.20.00	420	
					GF420KR	
				4250.30.00	420 10	
					420WGSZ	
				8505.40.00	KZI - 4,5	- Transmission type: ZF
				8516.40.00	KZI - 4,5	- Transmission type: Fuller
19.320 U,UL				3870.30.00	380 10	
					380/210GSZ	
				3892.20.00	380	
					GF2/380	
				3848.50.00	380	
					GF2/380	
				3871.30.00	380 10	
					380/70GSZ	
19.331 U				4244.20.00	420	
					GFX420KR	
				4281.30.00	420 10	
					420WGVZ	
				8505.40.00	KZI - 4,5	
19.361		D 2866		4200.90.03	420 10	
					GFX420KR	
				4244.20.00	420WGVZ	
				4281.30.00	KZI - 4,5	
				8516.40.00		
						
20...						
20.192 D,DHR				3539.20.00	350	
					GF350	
				3575.30.00	350 10	
					350WGSZ	
				3510.30.00	350 10	
					350W2GSZ	
				8533.40.00	KZI - 4,5	
20.240				3835.20.00	380	
					GF380	
				3857.30.00	380 10	
					380W2GSZ	
				8505.40.00	KZI - 4,5	
				4235.20.00	420	
					GF420KR	
				4235.30.00	420 10	
					420/210GS	
				4250.30.00	420 10	
					420WGSZ	
				8516.40.00	KZI - 4,5	- Transmission type: Fuller

Vehicle list







					
---	---	---	--	---	---

MAN



































20...

20.280		4235.20.00	420 GF420KR		
		4250.30.00	420 10 420WGSZ		
		8505.40.00	KZI - 4,5	- Transmission type: ZF	
		8516.40.00	KZI - 4,5	- Transmission type: Fuller	
20.281 20.321		4200.90.03	420 10 GFX420KR		
		4244.20.00	420WGVZ		
		4281.30.00	KZI - 4,5		
		8516.40.00			
		3856.10.00	380 GF2/380	- This part number includes one clutch disc	
		3894.30.00	380 10 380GSZ	- Loose clutch disc	
		8505.40.00	KZI - 4,5		
20.320		3856.20.00	380 G380KR	- Contained in xxxx.10.00	
		3848.50.00	380 GF2/380	- Contained in xxxx.10.00	
		3896.30.00	380 10 380WGSZ	- Contained in xxxx.10.00	
		4235.20.00	420 GF420KR		
		4250.30.00	420 10 420WGSZ		
		8505.40.00	KZI - 4,5	- Transmission type: ZF	
20.331		8516.40.00	KZI - 4,5	- Transmission type: Fuller	
		4200.90.03	420 10 GFX420KR		
		4244.20.00	420WGVZ		
		4281.30.00	KZI - 4,5		
		8516.40.00			
		3856.10.00	380 GF2/380	- This part number includes one clutch disc	
		3894.30.00	380 10 380GSZ	- Loose clutch disc	
21...		8505.40.00	KZI - 4,5		
		3856.20.00	380 G380KR	- Contained in xxxx.10.00	
		3848.50.00	380 GF2/380	- Contained in xxxx.10.00	
		3896.30.00	380 10 380WGSZ	- Contained in xxxx.10.00	
		3861.30.00	380 10 380W2GSZ		
		8505.40.00	KZI - 4,5		
21.212 21.215					
22...					
22.186 H		3521.20.00	350 GF350KR		
		8505.40.00	KZI - 4,5		







Vehicle list

					
---	---	---	--	---	---

MAN





















22...					
22.192			 3521.20.00	350 GF350KR	- Engine code: D2156MYN
			 3516.30.00	350 10 350WGSZ	- Engine code: D2156MYN
			 8505.40.00	KZI - 4,5	- Engine code: D2156MYN
			 3563.20.00	350 GMF350	- Engine code: D2565M
			 3539.20.00	350 GF350	- Engine code: D2565M
			 3575.30.00	350 10 350WGSZ	- Engine code: D2565M
			 8533.40.00	KZI - 4,5	- Engine code: D2565M
			 3510.30.00	350 10 350W2GSZ	- Engine code: D2565M
22.220	01.81 - 12.88		 3835.20.00	380 GF380	- Engine code: D2556MF
22.240			 3857.30.00	380 10 380W2GSZ	- Engine code: D2556MF
			 4235.20.00	420 GF420KR	- Engine code: D2556MF
			 4250.30.00	420 10 420WGSZ	- Engine code: D2556MF
			 8505.40.00	KZI - 4,5	- Engine code: D2556MF
22.230			 3861.30.00	380 10 380W2GSZ	
			 8505.40.00	KZI - 4,5	
22.256 DH			 4222.20.00	420 GF420KR	
22.304 DF			 4283.30.00	420 10 420WGSZ	
			 8505.40.00	KZI - 4,5	
22.280			 4235.20.00	420 GF420KR	
			 4250.30.00	420 10 420WGSZ	
			 8505.40.00	KZI - 4,5	- Transmission type: ZF
			 8516.40.00	KZI - 4,5	- Transmission type: Fuller
22.281 506	01.80 - 12.88		 4200.90.03	420 10	- Engine code: D2866
22.291 506	01.80 - 12.88		 4244.20.00	GFX420KR	
22.321 506	01.80 - 12.88		 4281.30.00	420WGVZ	
22.331 506	01.80 - 12.88		 8516.40.00	KZI - 4,5	
22.361 506	01.80 - 12.88		 3856.10.00	380 GF2/380	- Engine code: D2866 - This part number includes one clutch disc
			 3894.30.00	380 10 380GSZ	- Engine code: D2866 - Loose clutch disc
			 8505.40.00	KZI - 4,5	- Engine code: D2866
			 3856.20.00	380 G380KR	- Engine code: D2866 - Contained in xxxx.10.00
			 3848.50.00	380 GF2/380	- Engine code: D2866 - Contained in xxxx.10.00
			 3896.30.00	380 10 380WGSZ	- Engine code: D2866 - Contained in xxxx.10.00
			 4244.20.00	420 GFX420KR	- Engine code: D2866
			 4281.30.00	420 10 420WGVZ	- Engine code: D2866
			 8516.40.00	KZI - 4,5	- Engine code: D2866

Vehicle list







					
---	---	---	--	---	---

MAN

22...

22.320			 4224.20.00	420 GF420KR	- Engine code: D2530MF
			 4235.20.00	420 GF420KR	- Engine code: D2530MF
			 4250.30.00	420 10 420WGSZ	- Engine code: D2530MF
			 8505.40.00	KZI - 4,5	- Engine code: D2530MF - Transmission type: ZF
			 8516.40.00	KZI - 4,5	- Engine code: D2530MF - Transmission type: Fuller
22.320 UNL			 3889.10.00	380 GF2/380	- This part number includes one clutch disc
			 3870.30.00	380 10 380/210GSZ	- Loose clutch disc
			 8505.40.00	KZI - 4,5	
			 3892.20.00	380 GF2/380	- Contained in xxxx.10.00
			 3848.50.00	380 GF2/380	- Contained in xxxx.10.00
			 3871.30.00	380 10 380/70GSZ	- Contained in xxxx.10.00
22.361 930		D 2866	 4200.90.03  4244.20.00  4281.30.00  8516.40.00	420 10 GFX420KR 420WGVZ KZI - 4,5	- Engine code: D2866
22.403 22.463	01.97 - 01.97 -		 4300.90.05  4301.20.00  4346.30.00  8916.40.00	430 10 MFZ430 430WGTZ KZIZ - 5	- Engine code: D2866,2867
22.242 22.262 22.272 22.292 22.302 22.322 22.332 22.362 22.372 22.422	07.90 - 07.90 - 07.90 - 07.90 - 07.90 - 07.90 - 07.90 - 07.90 - 07.90 - 07.90 -		 4286.30.00	420 10 420WGTZ	- Engine code: D2866

24...

24.220 24.240	01.81 - 12.88 01.81 - 12.88		 3835.20.00	380 GF380	- Engine code: D2556MF
			 3857.30.00	380 10 380W2GSZ	- Engine code: D2556MF
			 4235.20.00	420 GF420KR	- Engine code: D2556MF
			 4224.20.00	420 GF420KR	- Engine code: D2556MF
			 4250.30.00	420 10 420WGSZ	- Engine code: D2556MF
			 8505.40.00	KZI - 4,5	- Engine code: D2556MF

Vehicle list

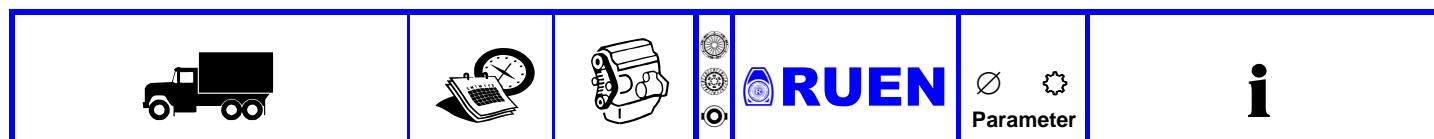

MAN







24...

24.291	01.80 - 12.88			4200.90.03	420 10	
24.331	01.80 - 12.88			4244.20.00	GFX420KR	
24.361	01.80 - 12.88			4281.30.00	420WGVZ	
				8516.40.00	KZI - 4,5	
				3856.10.00	380	- Engine code: D2866
					GF2/380	- This part number includes one clutch disc
				3894.30.00	380 10	- Engine code: D2866
					380GSZ	
				8505.40.00	KZI - 4,5	- Engine code: D2866
				3856.20.00	380	- Engine code: D2866
				G380KR		
			3848.50.00	380	- Engine code: D2866	
				GF2/380		
			3896.30.00	380 10	- Engine code: D2866	
				380WGSZ		
			4244.20.00	420	- Engine code: D2866	
				GFX420KR		
			4281.30.00	420 10	- Engine code: D2866	
				420WGVZ		
			8516.40.00	KZI - 4,5	- Engine code: D2866	
24.242	07.90 -			4286.30.00	420 10	- Engine code: D2866
24.262	07.90 -				420WGTZ	
24.292	07.90 -					
24.362	07.90 -					





























25...

25.220	01.81 - 12.88			3835.20.00	380	- Engine code: D2556MF
25.240	01.81 - 12.88			3857.30.00	380 10	- Engine code: D2556MF
				4235.20.00	420	- Engine code: D2556MF
				4250.30.00	420 10	- Engine code: D2556MF
				8505.40.00	KZI - 4,5	- Engine code: D2556MF
				4224.20.00	420	- Engine code: D2556MF
				GF420KR		
25.291	01.80 - 12.88			4200.90.03	420 10	- Engine code: D2866
25.331	01.80 - 12.88			4244.20.00	GFX420KR	
25.361	01.80 - 12.88			4281.30.00	420WGVZ	
				8516.40.00	KZI - 4,5	
				3856.10.00	380	- Engine code: D2866
					GF2/380	- This part number includes one clutch disc
				3894.30.00	380 10	- Engine code: D2866
					380GSZ	- Loose clutch disc
				8505.40.00	KZI - 4,5	- Engine code: D2866
				3856.20.00	380	- Engine code: D2866
				G380KR	- Contained in xxxx.10.00	
			3848.50.00	380	- Engine code: D2866	
				GF2/380	- Contained in xxxx.10.00	
			3896.30.00	380 10	- Engine code: D2866	
				380WGSZ	- Contained in xxxx.10.00	
			4244.20.00	420	- Engine code: D2866	
				GFX420KR		
			4281.30.00	420 10	- Engine code: D2866	
				420WGVZ		
			8516.40.00	KZI - 4,5	- Engine code: D2866	

Vehicle list

					
---	---	---	--	---	---

MAN

25...						
25.242	07.90 -			4286.30.00	420 10 420WGTZ	- Engine code: D2866; D2865;
25.262	07.90 -					
25.292	07.90 -					
25.332	07.90 -					
25.362	07.90 -					
26...						
26.215				3861.30.00	380 10 380W2GSZ	
26.230				8505.40.00	KZI - 4,5	
26.220		D 2556 MF		3835.20.00	380 GF380	
26.240				3857.30.00	380 10 380W2GSZ	
				4235.20.00	420 GF420KR	
				4250.30.00	420 10 420WGSZ	
				8505.40.00	KZI - 4,5	
26.232				3835.20.00	380 GF380	
				3857.30.00	380 10 380W2GSZ	
				8505.40.00	KZI - 4,5	
26.240		D 2566 MF		4235.20.00	420 GF420KR	
				4235.30.00	420 10 420/210GS	
				8505.40.00	KZI - 4,5	- Transmission type: ZF
				8533.40.00	KZI - 4,5	- Transmission type: Fuller
26.256				3835.20.00	380 GF380	
				3857.30.00	380 10 380W2GSZ	
				4235.20.00	420 GF420KR	
				4250.30.00	420 10 420WGSZ	
				8505.40.00	KZI - 4,5	- Transmission type: ZF
				8533.40.00	KZI - 4,5	- Transmission type: Fuller
26.256 H				4222.20.00	420 GF420KR	
26.304 DFL				4283.30.00	420 10 420WGSZ	
				8505.40.00	KZI - 4,5	
26.280				4235.20.00	420 GF420KR	
26.304				4250.30.00	420 10 420WGSZ	
				8505.40.00	KZI - 4,5	- Transmission type: ZF
				8533.40.00	KZI - 4,5	- Transmission type: Fuller

Vehicle list



MAN

26...

26.281	01.80 - 09.94	D 2866 MK		4200.90.03	420 10	
26.291	01.80 - 12.88			4244.20.00	GFX420KR	
26.321	01.80 - 09.94			4281.30.00	420WGVZ	
26.331	01.80 - 12.88			8516.40.00	KZI - 4,5	
				3856.10.00	380 GF2/380	- This part number includes one clutch disc
				3894.30.00	380 10 380GSZ	- Loose clutch disc
				8505.40.00	KZI - 4,5	
				3856.20.00	380 G380KR	- Contained in xxxx.10.00
				3848.50.00	380 GF2/380	- Contained in xxxx.10.00
				3896.30.00	380 10 380WGSZ	- Contained in xxxx.10.00
26.320				4235.20.00	420 GF420KR	
				4250.30.00	420 10 420WGSZ	
				8505.40.00	KZI - 4,5	- Transmission type: ZF
				8533.40.00	KZI - 4,5	- Transmission type: Fuller
26.361	01.80 - 12.88			4244.20.00	420 GFX420KR	
				4281.30.00	420 10 420WGVZ	
				8516.40.00	KZI - 4,5	
				3856.10.00	380 GF2/380	- This part number includes one clutch disc
				3894.30.00	380 10 380GSZ	- Loose clutch disc
				8505.40.00	KZI - 4,5	
				3856.20.00	380 G380KR	- Contained in xxxx.10.00
				3848.50.00	380 GF2/380	- Contained in xxxx.10.00
				3896.30.00	380 10 380WGSZ	- Contained in xxxx.10.00
26.365	02.83 - 06.90			4200.90.03	420 10	
				4244.20.00	GFX420KR	
				4281.30.00	420WGVZ	
				8516.40.00	KZI - 4,5	
				3856.10.00	380 GF2/380	- This part number includes one clutch disc
				3894.30.00	380 10 380GSZ	- Loose clutch disc
				8505.40.00	KZI - 4,5	
				3856.20.00	380 G380KR	- Contained in xxxx.10.00
				3848.50.00	380 GF2/380	- Contained in xxxx.10.00
				3896.30.00	380 10 380WGSZ	- Contained in xxxx.10.00





















27...

27.343	01.94 -			4300.90.49	430 10	
				4301.20.00	MFZ430	
				4346.30.00	430WGTZ	
				8916.40.00	KZIZ - 5	







Vehicle list

					
---	---	---	--	---	---

MAN























28...						
28.272				4286.30.00	420 10 420WGTZ	- Engine code: D2865LF; D2866LF
28.292	01.86 -					
28.302	01.90 -					
28.322	01.90 -					
28.332	01.86 -					
28.342	01.88 -					
28.372	01.90 -					
28.402	01.88 -					
28.422	01.90 -					
30...						
30.230				3861.20.00	380 GM380	
				8505.40.00	KZI - 4,5	
30.232				3835.20.00	380 GF380	
				3857.30.00	380 10 380W2GSZ	
				8505.40.00	KZI - 4,5	
30.240 30.256				3835.20.00	380 GF380	- Engine code: D2538M
				3857.30.00	380 10 380W2GSZ	- Engine code: D2538M
				8505.40.00	KZI - 4,5	- Engine code: D2538M
				4235.20.00	420 GF420KR	
				4250.30.00	420 10 420WGSZ	
				8516.40.00	KZI - 4,5	- Transmission type: Fuller
30.256 H				4222.20.00	420 GF420KR	
				4283.30.00	420 10 420WGSZ	
				8505.40.00	KZI - 4,5	
30.280				4235.20.00	420 GF420KR	
				4224.20.00	420 GF420KR	
				4250.30.00	420 10 420WGSZ	
				8505.40.00	KZI - 4,5	- Transmission type: ZF
				8516.40.00	KZI - 4,5	- Transmission type: Fuller
				4286.30.00	420 10 420WGTZ	- Engine code: D2566MF

Vehicle list

					
---	---	---	--	---	---

MAN



















30...

30.281 30.291 30.321 30.331			 3856.10.00	380 GF2/380	- Engine code: D2566 - To model year: 07.1983 - This part number includes one clutch disc
			 3894.30.00	380 10 380GSZ	- Engine code: D2566 - To model year: 07.1983 - Loose clutch disc
			 8505.40.00	KZI - 4,5	- Engine code: D2566 - To model year: 07.1983
			 3856.20.00	380 G380KR	- Engine code: D2566 - To model year: 07.1983 - Contained in xxxx.10.00
			 3848.50.00	380 GF2/380	- Engine code: D2566 - From model year: 07.1983 - Contained in xxxx.10.00
			 3896.30.00	380 10 380WGSZ	- Engine code: D2566 - To model year: 07.1983 - Contained in xxxx.10.00
			 4200.90.03  4244.20.00  4281.30.00  8516.40.00	420 10 GFX420KR 420WGVZ KZI - 4,5	- Engine code: D2566 - From model year: 08.1983
			 4244.20.00	420 GFX420KR	- Engine code: D2566 - From model year: 08/1983
			 4281.30.00	420 10 420WGVZ	- Engine code: 08/1983 - From model year: 08/1983
			 8516.40.00	KZI - 4,5	- Engine code: D2566 - From model year: 08/1983
30.304 30.320			 4224.20.00	420 GF420KR	
			 4235.20.00	420 GF420KR	
			 4250.30.00	420 10 420WGSZ	
			 8505.40.00	KZI - 4,5	- Transmission type: ZF
			 8516.40.00	KZI - 4,5	- Transmission type: Fuller
30.361			 4200.90.03  4244.20.00  4281.30.00  8516.40.00	420 10 GFX420KR 420WGVZ KZI - 4,5	- Engine code: D2866
30.262 30.272 30.292 30.302 30.322 30.332 30.362 30.372 30.422	01.89 - 01.92 - 01.87 - 01.90 - 01.90 - 01.87 - 01.87 - 01.90 - 01.90 -		 4286.30.00	420 10 420WGTZ	- Engine code: D2865LF; D2866LF; D2866KF,LXF

Vehicle list

					
---	---	---	--	---	---

MAN

31...						
31.262	01.89 -			4286.30.00	420 10 420WGTZ	- Engine code: D2865LF; D2866LF; D2866KF,LXF
31.272						
31.292	01.87 -					
31.302	01.90 -					
31.322	01.90 -					
31.332	01.87 -					
31.342	01.94 -					
31.362	01.87 -					
31.372	01.90 -					
31.402	01.94 -					
31.422	01.90 -					
32...						
32.232				3835.20.00	380 GF380	- Engine code: D2556MF
				3857.30.00	380 10 380W2GSZ	- Engine code: D2556MF
				8505.40.00	KZI - 4,5	- Engine code: D2556MF
32.240				3835.20.00	380 GF380	- Engine code: D2556MF
				3857.30.00	380 10 380W2GSZ	- Engine code: D2556MF
				8505.40.00	KZI - 4,5	- Engine code: D2556MF
				4268.30.00	420 10 420GSZ	- Engine code: D2556MF
				4235.20.00	420 GF420KR	
				4224.20.00	420 GF420KR	
				4250.30.00	420 10 420WGSZ	
32.256				3835.20.00	380 GF380	- Engine code: D2538M
				3857.30.00	380 10 380W2GSZ	- Engine code: D2538M
				8505.40.00	KZI - 4,5	- Engine code: D2538M
32.280		D 2530 MF		4224.20.00	420 GF420KR	- Engine code: D2530MF
				4235.20.00	420 GF420KR	- Engine code: D2530MF
				4250.30.00	420 10 420WGSZ	
				8505.40.00	KZI - 4,5	- Engine code: D2530MF - Transmission type: ZF
				8516.40.00	KZI - 4,5	- Engine code: D2530MF - Transmission type: Fuller

Vehicle list

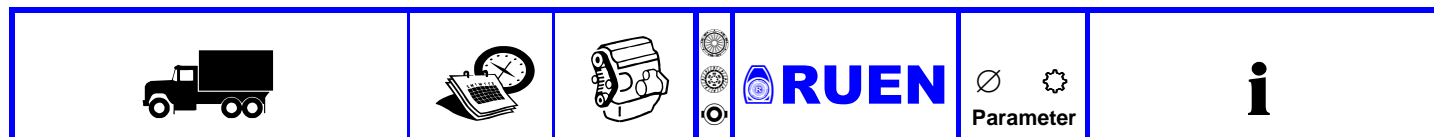







MAN

32...















32.281 32.321	01.80 - 09.94 01.80 - 09.94	D 2866 MK	4200.90.03 4244.20.00 4281.30.00 8516.40.00	420 10 GFX420KR 420WGVZ KZI - 4,5	
			3856.10.00	380 GF2/380	- This part number includes one clutch disc
			3894.30.00	380 10 380GSZ	- Loose clutch disc
			8505.40.00	KZI - 4,5	
			3856.20.00	380 G380KR	- Contained in xxxx.10.00
			3848.50.00	380 GF2/380	- Contained in xxxx.10.00
			3896.30.00	380 10 380WGSZ	- Contained in xxxx.10.00
			4244.20.00	420 GFX420KR	
			4281.30.00	420 10 420WGVZ	
			8516.40.00	KZI - 4,5	
32.291 32.331 32.361	08.83 - 08.83 -	D 2866	4200.90.03 4244.20.00 4281.30.00 8516.40.00	420 10 GFX420KR 420WGVZ KZI - 4,5	- Engine code: D2866
32.291 32.331	- 07.83 - 07.83	D 2866	3856.10.00	380 GF2/380	- Engine code: D2866 - This part number includes one clutch disc
			3894.30.00	380 10 380GSZ	- Engine code: D2866 - Loose clutch disc
			8505.40.00	KZI - 4,5	- Engine code: D2866
			3856.20.00	380 G380KR	- Engine code: D2866 - Contained in xxxx.10.00
			3848.50.00	380 GF2/380	- Engine code: D2866 - Contained in xxxx.10.00
			3896.30.00	380 10 380WGSZ	- Engine code: D2866 - Contained in xxxx.10.00
32.320			4224.20.00	420 GF420KR	- Engine code: D2538MT,D2530MF
			4235.20.00	420 GF420KR	- Engine code: D2538MT,D2530MF
			4250.30.00	420 10 420WGSZ	- Engine code: D2538MT,D2530MF
			8505.40.00	KZI - 4,5	- Engine code: D2538MT,D2530MF - Transmission type: ZF
			8516.40.00	KZI - 4,5	- Engine code: D2538MT,D2530MF - Transmission type: Fuller
32.320 DFA			3889.10.00	380 GF2/380	- This part number includes one clutch disc
			3870.30.00	380 10 380/210GSZ	- Engine code: D2530MF - Loose clutch disc
			8505.40.00	KZI - 4,5	- Engine code: D2530MF
			3892.20.00	380 GF2/380	- Engine code: D2530MF - Contained in xxxx.10.00
			3848.50.00	380 GF2/380	- Engine code: D2530MF - Contained in xxxx.10.00
			3871.30.00	380 10 380/70GSZ	- Engine code: D2530MF - Contained in xxxx.10.00

Vehicle list

















					
---	---	---	--	---	---

MAN







32...

32.365			 4200.90.03	420 10	- Engine code: D2840MF
			 4244.20.00	GFX420KR	
			 4281.30.00	420WGVZ	
			 8516.40.00	KZI - 4,5	
			 3856.10.00	380	- Engine code: D2840MF
				GF2/380	- This part number includes one clutch disc
			 3894.30.00	380 10	- Engine code: D2840MF
				380GSZ	- Loose clutch disc
			 8505.40.00	KZI - 4,5	- Engine code: D2840MF
			 3856.20.00	380	- Engine code: D2840MF
	G380KR	- Contained in xxxx.10.00			
 3848.50.00	380	- Engine code: D2840MF			
	GF2/380	- Contained in xxxx.10.00			
 3896.30.00	380 10	- Engine code: D2840MF			
	380WGSZ	- Contained in xxxx.10.00			
 4244.20.00	420	- Engine code: D2840MF			
	GFX420KR				
 4281.30.00	420 10	- Engine code: D2840MF			
	420WGVZ				
 8516.40.00	KZI - 4,5	- Engine code: D2840MF			
32.262	01.87 -		 4286.30.00	420 10	- Engine code: D2865LF; D2866LF;
32.272				420WGTZ	D2865; D2840LF;
32.292	01.85 -				
32.322	01.88 -				
32.332	01.85 -				
32.342	01.94 -				
32.372	01.88 -				
32.422	01.88 -				
32.462	01.85 -				





































33...

33.240			 3835.20.00	380	
			 3857.30.00	380 10	
			 8505.40.00	KZI - 4,5	
33.280 33.320		D 2530 MF	 4235.20.00	420	
			 4250.30.00	420 10	
			 8505.40.00	KZI - 4,5	- Transmission type: ZF
			 8516.40.00	KZI - 4,5	- Transmission type: Fuller
33.281			 4200.90.03	420 10	
			 4244.20.00	GFX420KR	
			 4281.30.00	420WGVZ	
			 8516.40.00	KZI - 4,5	
			 3856.10.00	380	- This part number includes one clutch disc
				GF2/380	
			 3894.30.00	380 10	- Loose clutch disc
	380GSZ				
 8505.40.00	KZI - 4,5				
 3856.20.00	380	- Contained in xxxx.10.00			
	G380KR				
 3848.50.00	380	- Contained in xxxx.10.00			
	GF2/380				
 3896.30.00	380 10	- Contained in xxxx.10.00			
	380WGSZ				







Vehicle list

					
---	---	---	--	---	---

































MAN

33...					
33.291			 3856.10.00	380 GF2/380	- To model year: 07.1983 - This part number includes one clutch disc
33.321			 3894.30.00	380 10 380GSZ	- To model year: 07.1983 - Loose clutch disc
33.331			 8505.40.00	KZI - 4,5	- To model year: 07.1983
			 3856.20.00	380 G380KR	- To model year: 07.1983 - Contained in xxxx.10.00
			 3848.50.00	380 GF2/380	- To model year: 07.1983 - Contained in xxxx.10.00
			 3896.30.00	380 10 380WGSZ	- To model year: 07.1983 - Contained in xxxx.10.00
			 4200.90.03	420 10	- From model year: 08.1983
			 4244.20.00	GFX420KR	
			 4281.30.00	420WGVZ	
			 8516.40.00	KZI - 4,5	
33.361			 4200.90.03	420 10	
			 4244.20.00	GFX420KR	
			 4281.30.00	420WGVZ	
			 8516.40.00	KZI - 4,5	
34...					
34.291	- 07.83		 3856.10.00	380 GF2/380	- This part number includes one clutch disc
34.331	- 07.83		 3894.30.00	380 10 380GSZ	- Loose clutch disc
			 8505.40.00	KZI - 4,5	
			 3856.20.00	380 G380KR	- Contained in xxxx.10.00
			 3848.50.00	380 GF2/380	- Contained in xxxx.10.00
			 3896.30.00	380 10 380WGSZ	- Contained in xxxx.10.00
			 4200.90.03	420 10	- From model year: 08.1983
			 4244.20.00	GFX420KR	
			 4281.30.00	420WGVZ	
			 8516.40.00	KZI - 4,5	
34.361			 4200.90.03	420 10	
			 4244.20.00	GFX420KR	
			 4281.30.00	420WGVZ	
			 8516.40.00	KZI - 4,5	
36...					
36.291			 4200.90.03	420 10	
36.331			 4244.20.00	GFX420KR	
			 4281.30.00	420WGVZ	
			 8516.40.00	KZI - 4,5	
36.361			4244.20.00	420 GFX420KR	
			4281.30.00	420 10 420WGVZ	
			8516.40.00	KZI - 4,5	
38...					
38.462	01.85 -		4300.90.05	430 10	- Engine code: D2840LF
			 4301.20.00	MFZ430	
			 4346.30.00	430WGTZ	
			 8916.40.00	KZIZ - 5	
38.462	01.85 -		 4286.30.00	420 10 420WGTZ	- Engine code: D2840LF































Vehicle list

					
---	---	---	--	---	---

MAN

38...					
38.262	01.85 -		 4009.30.00	400 10 400WGVZ	- Engine code: D2865LF
			 8916.40.00	KZIZ - 5	- Engine code: D2865LF
40...					
40.332	01.85 -		 4300.90.05	430 10 MFZ430	- Engine code: D2866LF
40.362	01.85 -		 4301.20.00	430WGTZ	
			 4346.30.00	KZIZ - 5	
			 8916.40.00		
40.400 UNL			 3870.30.00	380 10 380/210GSZ	- Loose clutch disc
			 8505.40.00	KZI - 4,5	
			 3892.20.00	380 GF2/380	- Contained in xxxx.10.00
			 3848.50.00	380 GF2/380	- Contained in xxxx.10.00
			 3871.30.00	380 10 380/70GSZ	- Contained in xxxx.10.00
40.242	01.85 -		 4008.30.00	400 10 400 WGVZ	- Engine code: D2865LF02,D2866F
			 8916.40.00	KZIZ - 5	- Engine code: D2865LF02,D2866F
40.262	01.85 -		 4009.30.00	400 10 400WGVZ	- Engine code: D2865LF; D2866LF
40.292	01.85 -		 8916.40.00	KZIZ - 5	- Engine code: D2865LF; D2866LF
41...					
41.291			 4244.20.00	420 GFX420KR	
			 4281.30.00	420 10 420WGVZ	
			 8516.40.00	KZI - 4,5	
41.331			 4200.90.03	420 10 GFX420KR	
41.361			 4244.20.00	420WGVZ	
			 4281.30.00	KZI - 4,5	
			 8516.40.00		
41.242	01.85 -		 4009.30.00	400 10 400WGVZ	- Engine code: D2865LF02,D2866F
			 4008.30.00	400 10 400 WGVZ	- Engine code: D2865LF02,D2866F
			 8916.40.00	KZIZ - 5	- Engine code: D2865LF02,D2866F
41.462	01.85 -		 4286.30.00	420 10 420WGTZ	- Engine code: D2840
41.502	01.85 -				
47...					
47.292	01.89 -		 4286.30.00	420 10 420WGTZ	- Engine code: D2866LF; D2866KF
47.332	01.89 -				
47.362	01.89 -				
48...					
48.291			 4200.90.03	420 10 GFX420KR	
48.331			 4244.20.00	420WGVZ	
48.361			 4281.30.00	KZI - 4,5	
			 8516.40.00		
48.372	01.89 -		 4286.30.00	420 10 420WGTZ	- Engine code: D2866LF
48.402	01.89 -				
48.422	01.89 -				

Vehicle list





						 RUEN		 Parameter			
MAN (TÜRKİYE)											
12.153 - 12.163											
12.153	01.01 - 12.03			3610.20.00	362 MFZ362						
				3610.30.00	362 10 362GTZ						
12.163/12.160/TGL 12.180											
12.163				3601.20.00	362 MF362						
				3607.30.00	362 10 362WGTZ						
26.230 - 26.210 - 26.240											
26.230				38106.30.00	380 10 380WGTZ						
				38107.30.00	380 10 380 GTZ						
26.210 - 26.240				3821.20.00	380 GF380KR						
				38106.30.00	380 10 380WGTZ						
				38107.30.00	380 10 380 GTZ						
19.270 - 26.270 - 32.270											
19.270 - 26.270 - 32.270				3956.20.00	395 MFZ395						
				3951.30.00	395 10 395WGTZ						
40.463											
40.463				4028.10.00	400 MFZ2/400X						
				4026.30.00	400 8 400GTZ						
				4036.30.00	400 10 400 WGTZ						
19.280 - 26.280											
19.280 - 26.280				4235.20.00	420 GF420KR						
				4250.30.00	420 10 420WGSZ						
				42105.30.00	420 10 420 WGTZ						
				4258.30.00	420 10 420GSZ						
26.281 - 26.321											
26.281 - 26.321				4244.20.00	420 GFX420KR						
				4281.30.00	420 10 420WGVZ						
26.372-33.372-19.422-...-S2000											
S2000 - 19.422				4301.20.00	430 MFZ430						
				4306.30.00	430 10 430WGTZ						
				8916.40.00	KZIZ - 5						
INSAAT SERISI (PTO'lu)											
TGA 41.400				4306.30.00	430 10 430WGTZ						

Vehicle list



					
---	---	---	--	---	---

MAN (TÜRKİYE)



















TGA (310 - 430 BG ARASI)

TGA D2866 & D2066 Motorlu		4319.20.00	430 MFZ430	
		4306.30.00	430 10 430WGTZ	
		8916.40.00	KZIZ - 5	
TGA AS-Tronic Snz		8919.40.00	KZISZ - 5	







TGA (460 -530 BG ARASI)

TGA D2876 Motorlu		8916.40.00	KZIZ - 5	
TGA AS-Tronic Snz		8919.40.00	KZISZ - 5	













MAZ

MAZ				
4370		3608.20.00	362 MF362	- GBox: ZF S5-42 - GBox: Smolensk
		3607.30.00	362 10 362WGTZ	- GBox: ZF S5-42 - GBox: Smolensk
		7201.40.00	KZI - 3	- GBox: ZF S5-42
		7904.40.00	Kzi-3	- GBox: Smolensk
4570		3608.20.00	362 MF362	- GBox: Smolensk CAAZ-433420
		3608.30.00	362 10 362WGTZ	- GBox: Smolensk CAAZ-433420
		8539.40.00	KZI-4.5	- GBox: Smolensk CAAZ-433420
5336		3951.20.00	395 MF395	- GBox: ZF 9S-109 - GBox: ZF 9S- 75
		3951.30.00	395 10 395WGTZ	- GBox: ZF 9S-109 - GBox: ZF 9S- 75
		8537.40.00	KZI-4.5	- GBox: ZF 9S-109 - GBox: ZF 9S- 75
5337		3951.20.00	395 MF395	- GBox: ZF 6S-850
		3951.30.00	395 10 395WGTZ	- GBox: ZF 6S-850
		8537.40.00	KZI-4.5	- GBox: ZF 6S-850
5516		3951.20.00	395 MF395	- GBox: ZF 9S-109 - GBox: ZF 16S-109
		3951.30.00	395 10 395WGTZ	- GBox: ZF 9S-109 - GBox: ZF 16S-109
		8537.40.00	KZI-4.5	- GBox: ZF 9S-109 - GBox: ZF 16S-109
		4301.20.00	430 MFZ430	- GBox: ZF16S- 221
		4305.30.00	430 10 430W2GTZ	- GBox: ZF16S- 221
		8916.40.00	KZIZ - 5	- GBox: ZF16S- 221



Vehicle list

					
---	---	---	--	---	---







MAZ

MAZ					
5551		4301.20.00	430 MFZ430	- GBox: ZF9S- 109	
		4316.30.00	430 10 430WGTZ	- GBox: ZF9S- 109	
		8935.40.00	KZISZ - 5	- GBox: ZF9S- 109	
		3951.20.00	395 MF395	- GBox: ZF9S- 109 - GBox: ZF9S- 75	
		3951.30.00	395 10 395WGTZ	- GBox: ZF9S- 109 - GBox: ZF9S- 75	
		8537.40.00	KZI-4.5	- GBox: ZF9S- 109 - GBox: ZF9S- 75	
6303		3951.20.00	395 MF395	- GBox: ZF9S- 109 - GBox: ZF16S- 109	
		3951.30.00	395 10 395WGTZ	- GBox: ZF9S- 109 - GBox: ZF16S- 109	
		8537.40.00	KZI-4.5	- GBox: ZF9S- 109 - GBox: ZF16S- 109	
631733		3951.20.00	395 MF395	- GBox: ZF9S- 109	
		3951.30.00	395 10 395WGTZ	- GBox: ZF9S- 109	
		8539.40.00	KZI-4.5	- GBox: ZF9S- 109	

MAZ Baltija



MAZ Baltija		3951.20.00	395 MF395	- GBox: ZF 9S- 109
		3951.30.00	395 10 395WGTZ	- GBox: ZF 9S- 109
		8533.40.00	KZI - 4,5	- GBox: ZF 9S- 109

Truck



631208 / 643008		4301.20.00	430 MFZ430	- GBox: Shaanxi 9JS 180 A
		4305.30.00	430 10 430W2GTZ	- GBox: Shaanxi 9JS 180 A
		8916.40.00	KZIZ - 5	- GBox: Shaanxi 9JS 180 A
544005 / 534005		4301.20.00	430 MFZ430	- GBox: Shaanxi 9JS 150 F
		4305.30.00	430 10 430W2GTZ	- GBox: Shaanxi 9JS 150 F
		8916.40.00	KZIZ - 5	- GBox: Shaanxi 9JS 150 F

MERCEDES (TÜRKİYE)

UNIMOĞ

UNIMOĞ		3305.20.00	330 GMF330	
		3325.30.00	330 10 330WGSZ	
UNIMOĞ		3565.20.00	350 GMF350	

2517 - 2521



MERCEDES TURK KAMYON		3580.20.00	350 GMF350	
		3599.30.00	350 10 350 GTZ	
		3597.30.00	350 10 350 WGTZ	

Vehicle list



					
---	---	---	--	---	---

MERCEDES (TÜRKİYE)





ATEGO 1215 - 1517

ATEGO OM904 LA		3606.20.00	362 MF362
		3626.30.00	362 18 362 WGTZ



2524

2524		3822.20.00	380 GF380KR
		38107.30.00	380 10 380 GTZ





1935 - 2635

1935 - 2635		3882.10.00	380 GF2/380
		3882.20.00	380 GF2/380
		3855.30.00	380 10 380GS
		3882.30.00	380 10 380GSZ









AXOR 1823....3228

AXOR OM906 LA		3951.20.00	395 MF395
		3961.30.00	395 18 395GTZ



4037 - 4038

4037-4038		4010.10.00	400 MFZ2/400X
		4021.30.00	400 10 400GVZ
		4020.30.00	400 10 400GVZ
		8928.40.00	KZIZ - 5



ACTROS

ACTROS		4000.90.04	400 18 MFZ2/400X
		4025.10.00	400 MFZ2/400X
		4025.30.00	400 18 400WGTZ
ACTROS		4025.10.00	400 MFZ2/400X
		4025.30.00	400 18 400WGTZ
		4300.90.15 ⊕	430 18 MFZ430
		4329.60.00 ⊕	430 MFZ430
		4318.30.00	430 18 430WGTZ
		8918.40.00	KZISZ - 5







1922 - 2622 (OM 421)

1922 - 2622		4235.20.00	420 GF420KR
		4232.30.00	420 10 420GSZ

2628 (OM 422)



2628		4235.20.00	420 GF420KR
		4212.30.00	420 10 420/210GSZ

Vehicle list



					
---	---	---	--	---	---

MERCEDES (TÜRKİYE)



2036 - 2236 - 2636 (V 10)

2036 - 2236 - 2636		4244.20.00	420 GFX420KR
		4212.30.00	420 10 420/210GSZ

2629 - 2631 - 3027 - 3031

MERCEDES KAMYON		4304.20.00	430 MFZ430
		4305.30.00	430 10 430W2GTZ
		4306.30.00	430 10 430WGTZ

1844 - 1938

MERCEDES CEKICI		4300.20.00	430 MFZ430
		4306.30.00	430 10 430WGTZ



KAMYON

MERCEDES KAMYON		4312.30.00	430 10 430W2GTZ
-----------------	---	------------	--------------------

AXOR INSAAT SERISI (PTO'lu)

AXOR 4140		4318.30.00	430 18 430WGTZ
-----------	--	------------	-------------------













AXOR 1835-1840-2640-3240..4140

AXOR OM457 LA EURO 3		4329.60.00 ⊕	430 MFZ430
		4318.30.00	430 18 430WGTZ
		8918.40.00	KZISZ - 5

MERCEDES-BENZ

ACTROS 1831 - 1863

04.96 -

1831 AK 952.072, 952.073 1831 K 952.002, 952.003	04.97 - 10.02 04.97 - 10.02	OM 541.920 OM 541.926 OM 541.941		4300.90.15 ⊕	430 18 MFZ430	- Engine code: OM 541 - Vehicles with single clutch disc
				4329.60.00	430WGTZ	
				4318.30.00	430WGTZ	
				4300.90.90 ⊕	430 18 MFZ430	- Engine code: OM 541 - Vehicles with single clutch disc - Equipment Var: SA 504682-22/24
				4340.60.00	430WGTZ	
				4350.30.00	430 18 430WGTZ	- Engine code: OM 541 - For PTO - Vehicles with single clutch disc
				4000.90.04	400 18 MFZ2/400X	- Engine code: OM 541 - Vehicles with double disc clutch
				4025.10.00	400WGTZ	
				4025.30.00	400WGTZ	
				4000.90.17	400 18 MFZ2/400X	- Engine code: OM 541 - Vehicles with double disc clutch - GBox: Powershift
				4022.10.00	400WGTZ	
				4025.30.00	400WGTZ	

Vehicle list

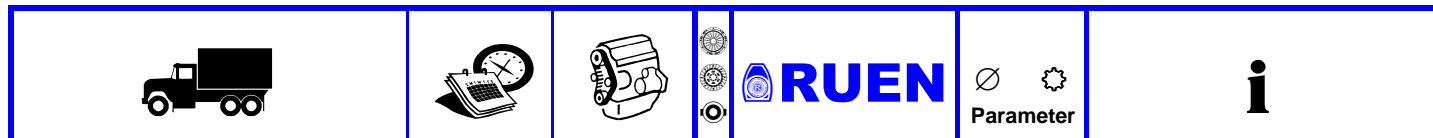

MERCEDES-BENZ

ACTROS 1831 - 1863

04.96 -

1831,1831 L 1835,1835 L	04.96 - 10.02	OM 541.920	4300.90.15 ⊕	430 18	- Engine code: OM 541 - Vehicles with single clutch disc	
	04.96 - 10.02	OM 541.922	4329.60.00	MFZ430		
			4318.30.00	430WGTZ		
			4300.90.90 ⊕	430 18		- Engine code: OM 541 - Vehicles with single clutch disc - Equipment Var: SA 504682-22/24
			4340.60.00	MFZ430		
			4350.30.00	430WGTZ		
4350.30.00		430 18	430WGTZ	- Engine code: OM 541 - For PTO - Vehicles with single clutch disc		
4000.90.04		400 18	MFZ2/400X	- Engine code: OM 541 - Vehicles with double disc clutch		
4025.10.00			400WGTZ			
4025.30.00						
4000.90.17		400 18	MFZ2/400X	- Engine code: OM 541 - Vehicles with double disc clutch - GBox: Powershift		
4022.10.00			400WGTZ			
4025.30.00						
4300.90.50 ⊕		430 18	MFZ430			
4318.60.00			430WGTZ			
4318.30.00						
1831 S, 1831 LS 954.033, 954.042, 954.003, 954.062, 954.002, 954.053, 954.032 1835 S,1835 LS 954.033, 954.042, 954.003, 954.062, 954.002, 954.053, 954.032	04.96 - 10.02	OM 541.920	4300.90.15 ⊕	430 18	- Engine code: OM 541 - Vehicles with single clutch disc	
	04.96 - 10.02	OM 541.922	4329.60.00	MFZ430		
			4318.30.00	430WGTZ		
			4300.90.90 ⊕	430 18		- Engine code: OM 541 - Vehicles with single clutch disc - Equipment Var: SA 504682-22/24
			4340.60.00	MFZ430		
			4350.30.00	430WGTZ		
4350.30.00		430 18	430WGTZ	- Engine code: OM 541 - For PTO - Vehicles with single clutch disc		
4000.90.04		400 18	MFZ2/400X	- Engine code: OM 541 - Vehicles with double disc clutch		
4025.10.00			400WGTZ			
4025.30.00						
4000.90.17		400 18	MFZ2/400X	- Engine code: OM 541 - Vehicles with double disc clutch - GBox: Powershift		
4022.10.00			400WGTZ			
4025.30.00						
4300.90.50 ⊕		430 18	MFZ430			
4318.60.00			430WGTZ			
4318.30.00						
1832, L, LL 1836, L, LL 1841, L, LL 1844, L, LL 1846, L, LL	04.03 -	OM 541.940	4300.90.15 ⊕	430 18	- Engine code: OM 541 - Vehicles with single clutch disc	
	04.03 -	OM 541.942	4329.60.00	MFZ430		
	04.03 -	OM 541.944	4318.30.00	430WGTZ		
	04.03 -	OM 541.946	4300.90.90 ⊕	430 18		
	04.03 -	OM 541.948	4340.60.00	MFZ430		
	04.03 -	OM 541.970	4350.30.00	430WGTZ		
		OM 541.974				
		OM 541.976				
	OM 541.980					
4350.30.00		430 18	430WGTZ	- Engine code: OM 541 - For PTO - Vehicles with single clutch disc		
4000.90.04		400 18	MFZ2/400X	- Engine code: OM 541 - Vehicles with double disc clutch		
4025.10.00			400WGTZ			
4025.30.00						
4000.90.17		400 18	MFZ2/400X	- Engine code: OM 541 - Vehicles with double disc clutch - GBox: Powershift		
4022.10.00			400WGTZ			
4025.30.00						

Vehicle list

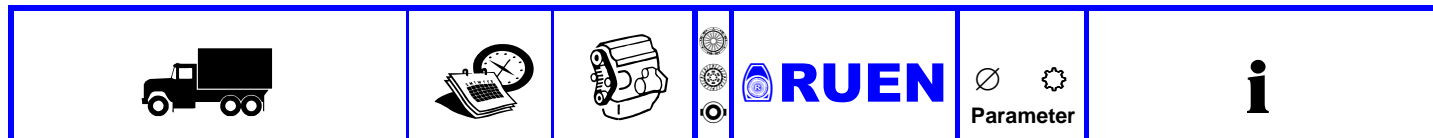

MERCEDES-BENZ

ACTROS 1831 - 1863

04.96 -

1832 AK 932.073, 932.072	04.03 -	OM 541.921	4300.90.15 ⊕	430 18	- Engine code: OM 541
1832 K 932.002, 932.003	04.03 -	OM 541.940	4329.60.00	MFZ430	- Vehicles with single clutch disc
1832 LS, LLS 934.053, 934.062, 934.032, 934.031, 934.042, 934.033	04.03 -	OM 541.942	4318.30.00	430WGTZ	
1836 AK 932.073, 932.072	04.03 -	OM 541.944	4300.90.90 ⊕	430 18	- Engine code: OM 541
1836 K 932.002, 932.003	04.03 -	OM 541.946	4340.60.00	MFZ430	- Vehicles with single clutch disc
1836 LS, LLS 934.053, 934.062, 934.032, 934.031, 934.042, 934.033	04.03 -	OM 541.948	4350.30.00	430WGTZ	- Equipment Var: SA 504682-22/24
1841 K 932.002, 932.003	04.03 -	OM 541.949	4350.30.00	430 18	- Engine code: OM 541
1841 LS, LLS 934.053, 934.062, 934.032, 934.031, 934.042, 934.033	04.03 -	OM 541.970		430WGTZ	- For PTO
1844 AK 932.073, 932.072	04.03 -	OM 541.971	4000.90.04	400 18	- Engine code: OM 541
1844 K 932.002, 932.003	04.03 -	OM 541.974	4025.10.00	MFZ2/400X	- Vehicles with double disc clutch
1844 LS, LLS 934.053, 934.062, 934.032, 934.031, 934.042, 934.033	04.03 -	OM 541.976	4025.30.00	400WGTZ	
1846 AK 932.073, 932.072	04.03 -	OM 541.978	4000.90.17	400 18	- Engine code: OM 541
1846 K 932.002, 932.003	04.03 -	OM 541.980	4022.10.00	MFZ2/400X	- Vehicles with double disc clutch
1846 LS, LLS 934.053, 934.062, 934.032, 934.031, 934.042, 934.033	04.03 -	OM 541.981	4025.30.00	400WGTZ	- GBox: Powershift
1848 AK 932.073, 932.072, 932.083, 11946cc	04.03 -	OM 541.995			
1848 K 932.002, 932.003, 11946cc	04.03 -				
1848, LS, LLS 934.053, 934.032, 934.042, 934.033	04.03 -				
1835 AK 952.073	04.97 - 10.02	OM 541.921	4300.90.15 ⊕	430 18	- Engine code: OM 541
1835 K 952.003	04.97 - 10.02	OM 541.922	4329.60.00	MFZ430	- Vehicles with single clutch disc
1840 AK 952.073	04.97 - 10.02	OM 541.923	4318.30.00	430WGTZ	
1840 K 952.003	04.97 - 10.02	OM 541.924	4300.90.90 ⊕	430 18	- Engine code: OM 541
1840, 1840 L	04.96 - 10.02	OM 541.925	4340.60.00	MFZ430	- Vehicles with single clutch disc
1843 AK 952.073	04.97 - 10.02	OM 541.927	4350.30.00	430WGTZ	- Equipment Var: SA 504682-22/24
1843 K 952.003	04.97 - 10.02	OM 541.947	4350.30.00	430 18	- Engine code: OM 541
				430WGTZ	- For PTO
			4000.90.04	400 18	- Engine code: OM 541
			4025.10.00	MFZ2/400X	- Vehicles with double disc clutch
			4025.30.00	400WGTZ	
			4000.90.17	400 18	- Engine code: OM 541
			4022.10.00	MFZ2/400X	- Vehicles with double disc clutch
			4025.30.00	400WGTZ	- GBox: Powershift
1840 S, 1840 LS 954.033, 954.042, 954.003, 954.062, 954.002, 954.053, 954.032	04.96 - 10.02	OM 541.923	4300.90.15 ⊕	430 18	- Engine code: OM 541
1843 S, 1843 LS 954.033, 954.042, 954.003, 954.062, 954.002, 954.053, 954.032	04.96 - 10.02	OM 541.925	4329.60.00	MFZ430	- Vehicles with single clutch disc
1843, 1843 L	04.96 - 10.02		4318.30.00	430WGTZ	
			4300.90.90 ⊕	430 18	- Engine code: OM 541
			4340.60.00	MFZ430	- Vehicles with single clutch disc
			4350.30.00	430WGTZ	- Equipment Var: SA 504682-22/24
			4350.30.00	430 18	- Engine code: OM 541
				430WGTZ	- For PTO
					- Vehicles with single clutch disc
			4000.90.04	400 18	- Engine code: OM 541
			4025.10.00	MFZ2/400X	- Vehicles with double disc clutch
			4025.30.00	400WGTZ	
			4000.90.17	400 18	- Engine code: OM 541
			4022.10.00	MFZ2/400X	- Vehicles with double disc clutch
			4025.30.00	400WGTZ	- GBox: Powershift

Vehicle list



MERCEDES-BENZ

ACTROS 1831 - 1863		04.96 -				
1848,1848 L 950.036, 950.004, 950.006 950.032, 950.034 1853,1853 L 950.036, 950.004, 950.006, 950.032, 950.034	04.96 - 10.02	OM 542.920	4300.90.381 ⊕	430 18	- Engine code: OM 542 - Vehicles with single clutch disc	
	04.96 - 10.02	OM 542.921	4329.60.00	MFZ430		
			4351.30.00	430WGTZ		
	04.96 - 10.02		4000.90.04	400 18	- Engine code: OM 542 - Vehicles with double disc clutch	
			4025.10.00	MFZ2/400X		
			4025.30.00	400WGTZ		
	04.96 - 10.02		4000.90.17	400 18	- Engine code: OM 542 - Vehicles with double disc clutch - GBox: Powershift	
			4022.10.00	MFZ2/400X		
			4025.30.00	400WGTZ		
1848 AK 952.073, 15928cc 1848 K 952.003, 15928cc	04.97 - 10.02	OM 542.921	4300.90.381 ⊕	430 18	- Engine code: OM 542 - Vehicles with single clutch disc	
	04.97 - 10.02	OM 542.925	4329.60.00	MFZ430		
			4351.30.00	430WGTZ		
	04.97 - 10.02		4000.90.04	400 18	- Engine code: OM 542 - Vehicles with double disc clutch	
			4025.10.00	MFZ2/400X		
			4025.30.00	400WGTZ		
	04.97 - 10.02		4000.90.17	400 18	- Engine code: OM 542 - Vehicles with double disc clutch - GBox: Powershift	
			4022.10.00	MFZ2/400X		
			4025.30.00	400WGTZ		
1848 S,1848 LS 954.033, 954.003, 954.002, 954.032 1850, 1851, L, LL 930.032, 930.036, 930.034, 930.004 1853 S,1853 LS 954.033, 954.003, 954.002, 954.032 1854, L 930.032, 930.036, 930.034, 930.004	04.96 - 10.02	OM 542.920	4300.90.381 ⊕	430 18	- Engine code: OM 542 - Vehicles with single clutch disc	
	04.03 -	OM 542.921	4329.60.00	MFZ430		
			4351.30.00	430WGTZ		
	04.03 -	OM 542.940	4000.90.04	400 18	- Engine code: OM 542 - Vehicles with double disc clutch	
			4025.10.00	MFZ2/400X		
			4025.30.00	400WGTZ		
	04.03 -	OM 542.942	4000.90.17	400 18	- Engine code: OM 542 - Vehicles with double disc clutch - GBox: Powershift	
			4022.10.00	MFZ2/400X		
			4025.30.00	400WGTZ		
	04.03 -	OM 542.960	4000.90.17	400 18	- Engine code: OM 542 - Vehicles with double disc clutch - GBox: Powershift	
			4022.10.00	MFZ2/400X		
			4025.30.00	400WGTZ		
1854, L 930.032, 930.036, 930.034, 930.004	04.03 -	OM 542.962	4300.90.382 ⊕	430 18	- Engine code: OM 542 - Vehicles with single clutch disc	
	04.03 -		4349.60.00	MFZ430		
			4352.30.00	430WGTZ		
	04.03 -		4000.90.04	400 18	- Engine code: OM 542 - Vehicles with single clutch disc	
			4025.10.00	MFZ2/400X		
			4025.30.00	400WGTZ		
	04.03 -		4000.90.17	400 18	- Engine code: OM 542 - Vehicles with double disc clutch - GBox: Powershift	
			4022.10.00	MFZ2/400X		
			4025.30.00	400WGTZ		
1858, L 930.034	04.03 -	OM 542.944	4300.90.382 ⊕	430 18	- Engine code: OM 542 - Vehicles with single clutch disc	
	04.03 -		4349.60.00	MFZ430		
			4352.30.00	430WGTZ		
	04.03 -		4000.90.04	400 18	- Engine code: OM 542 - Vehicles with single clutch disc	
			4025.10.00	MFZ2/400X		
			4025.30.00	400WGTZ		
	04.03 -		4000.90.17	400 18	- Engine code: OM 542 - Vehicles with double disc clutch - GBox: Powershift	
			4022.10.00	MFZ2/400X		
			4025.30.00	400WGTZ		
1850 AK, 1851 AK 932.073 1850, 1851 K 932.003 1850, 1851 LS, LLS 934.032, 934.033 1854 LS 934.032, 934.033 1858 LS 934.032	04.03 -	OM 542.940	4300.90.381 ⊕	430 18	- Engine code: OM 542 - Vehicles with single clutch disc	
	04.03 -	OM 542.942	4329.60.00	MFZ430		
	04.03 -	OM 542.944	4351.30.00	430WGTZ		
	04.03 -	OM 542.944	4000.90.04	400 18	- Engine code: OM 542 - Vehicles with double disc clutch	
			4025.10.00	MFZ2/400X		
			4025.30.00	400WGTZ		
	04.03 -	OM 542.960	4000.90.17	400 18	- Engine code: OM 542 - Vehicles with double disc clutch - GBox: Powershift	
			4022.10.00	MFZ2/400X		
			4025.30.00	400WGTZ		
1854 LS 934.032 1858 LS 934.032	10.02 -		4000.90.17	400 18	- Engine code: OM 542 - Vehicles with double disc clutch - GBox: Powershift	
	04.03 -		4022.10.00	MFZ2/400X		
			4025.30.00	400WGTZ		
1857 L 950.034 1857 LS 954.033, 954.032	04.97 - 10.02	OM 542.922	4300.90.382 ⊕	430 18	- Engine code: OM 542 - Vehicles with single clutch disc	
	04.97 - 10.02		4349.60.00	MFZ430		
			4352.30.00	430WGTZ		
	04.97 - 10.02		4000.90.04	400 18	- Engine code: OM 542 - Vehicles with double disc clutch	
			4025.10.00	MFZ2/400X		
			4025.30.00	400WGTZ		
	04.97 - 10.02		4000.90.17	400 18	- Engine code: OM 542 - Vehicles with double disc clutch - GBox: Powershift	
			4022.10.00	MFZ2/400X		
			4025.30.00	400WGTZ		

Vehicle list

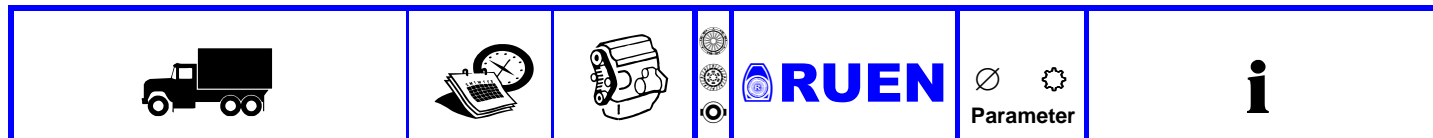

MERCEDES-BENZ

ACTROS 1831 - 1863

04.96 -

1831 AK 932.073, 932.072	04.03 -	OM 541.920	4300.90.15 ⊕	430 18	- Engine code: OM 541 - Vehicles with single clutch disc
1831 K 932.002, 932.003	04.03 -	OM 541.922	4329.60.00	MFZ430	
1835 AK 932.073, 932.072	04.03 -	OM 541.923	4318.30.00	430WGTZ	
1835 K 932.002, 932.003	04.03 -	OM 541.924	4300.90.90 ⊕	430 18	- Engine code: OM 541 - Vehicles with single clutch disc
1836 A 930.083	04.03 -	OM 541.926	4340.60.00	MFZ430	- Equipment Var: SA 504682-22/24
1840 AK 932.073, 932.072	04.03 -	OM 541.927	4350.30.00	430WGTZ	
1840 K 932.002, 932.003	04.03 -	OM 541.940	4350.30.00	430 18	- Engine code: OM 541 - For PTO
1841 AK 1841 AK	04.03 -	OM 541.941		430WGTZ	- Vehicles with single clutch disc
1846 AK 952.073	04.97 - 10.03	OM 541.942	4000.90.04	400 18	- Engine code: OM 541
1846 S, 1846 LS 954.033, 954.042, 954.003, 954.062, 954.002, 954.053, 954.032	10.98 -	OM 541.943	4025.10.00	MFZ2/400X	- Vehicles with double disc clutch
1848, L, LL	04.03 -	OM 541.944	4025.30.00	400WGTZ	
		OM 541.945	4000.90.17	400 18	- Engine code: OM 541 - Vehicles with double disc clutch
		OM 541.948	4022.10.00	MFZ2/400X	- GBox: Powershift
		OM 541.949	4025.30.00	400WGTZ	
		OM 541.978			
		OM 541.991			
1848 AK 932.073	04.03 -	OM 542.921	4300.90.381 ⊕	430 18	- Engine code: OM 542 - Vehicles with single clutch disc
1848 K 932.002, 932.003	04.03 -	OM 542.925	4329.60.00	MFZ430	
1848 S, LS 934.032, 934.033	04.03 -	OM 542.940	4351.30.00	430WGTZ	
1848, L, LL 930.032, 930.036, 930.034, 930.004	04.03 -	OM 542.941	4000.90.04	400 18	- Engine code: OM 542 - Vehicles with double disc clutch
1850 AK 952.073	10.97 -		4025.10.00	MFZ2/400X	
			4025.30.00	400WGTZ	
			4000.90.17	400 18	- Engine code: OM 542 - Vehicles with double disc clutch
			4022.10.00	MFZ2/400X	- GBox: Powershift
			4025.30.00	400WGTZ	
1858 L 963.003	01.14 -	OM 473.903	4000.90.18	400 18	- Engine code: OM 473
1858 LS 963.403	01.14 -	OM 473.905	4021.10.00	MFZ2/400X	
1863 L 963.003	01.14 -		4025.30.00	400WGTZ	
1863 LS 963.403	01.14 -		8947.40.00	KZISZ-5	
1860 L, LL 930.034	05.05 -	OM 542.958	4300.90.382 ⊕	430 18	- Engine code: OM 542 - Vehicles with single clutch disc
1860 LS 934.032, 934.033	06.08 -	OM 542.964	4349.60.00	MFZ430	
1861 LS 934.032	05.05 -		4352.30.00	430WGTZ	
			4000.90.04	400 18	- Engine code: OM 542 - Vehicles with double disc clutch
			4025.10.00	MFZ2/400X	
			4025.30.00	400WGTZ	
			4000.90.17	400 18	- Engine code: OM 542 - Vehicles with double disc clutch
			4022.10.00	MFZ2/400X	- GBox: Powershift
			4025.30.00	400WGTZ	

Vehicle list



MERCEDES-BENZ

ACTROS 2031 - 2054		04.96 -				
2031 A 950.083	04.97 - 10.02	OM 541.920		4300.90.15 ⊕	430 18	- Engine code: OM 541
2031 AK 952.083	09.96 - 10.02	OM 541.926		4329.60.00	MFZ430	- Vehicles with single clutch disc
2031 AS 954.082	04.96 - 10.02			4318.30.00	430WGTZ	
2031 K 952.013	04.97 - 10.02			4300.90.90 ⊕	430 18	- Engine code: OM 541
2031 S 954.012	04.96 - 10.02			4340.60.00	MFZ430	- Vehicles with single clutch disc
				4350.30.00	430WGTZ	- Equipment Var: SA 504682-22/24
				4350.30.00	430 18	- Engine code: OM 541
					430WGTZ	- For PTO
						- Vehicles with single clutch disc
				4000.90.04	400 18	- Engine code: OM 541
				4025.10.00	MFZ2/400X	- Vehicles with double disc clutch
				4025.30.00	400WGTZ	
				4000.90.17	400 18	- Engine code: OM 541
				4022.10.00	MFZ2/400X	- Vehicles with double disc clutch
				4025.30.00	400WGTZ	- GBox: Powershift
				4300.90.50 ⊕	430 18	
				4318.60.00	MFZ430	
				4318.30.00	430WGTZ	
2032 AK 932.083	04.03 -	OM 541.920		4300.90.15 ⊕	430 18	- Engine code: OM 541
2032 AS 934.082	04.03 -	OM 541.921		4329.60.00	MFZ430	- Vehicles with single clutch disc
2032 K 932.013	04.03 -	OM 541.923		4318.30.00	430WGTZ	
2032 S 934.013, 934.012	04.03 -	OM 541.924		4300.90.90 ⊕	430 18	- Engine code: OM 541
2036 AK 932.083	04.03 -	OM 541.925		4340.60.00	MFZ430	- Vehicles with single clutch disc
2036 AS 934.082, 934.083	04.03 -	OM 541.926		4350.30.00	430WGTZ	- Equipment Var: SA 504682-22/24
2036 S 934.013, 934.012	04.03 -	OM 541.927				
2041 AK 932.083	04.03 -	OM 541.940		4350.30.00	430 18	- Engine code: OM 541
2041 AS 934.082	04.03 -	OM 541.941			430WGTZ	- For PTO
2041 K 932.013	04.03 -	OM 541.942				- Vehicles with single clutch disc
2041 S	04.03 -	OM 541.943		4000.90.04	400 18	- Engine code: OM 541
2044 AS 934.082	04.03 -	OM 541.944		4025.10.00	MFZ2/400X	- Vehicles with double disc clutch
2044 AK 932.083	04.03 -	OM 541.946		4025.30.00	400WGTZ	
2044 S 934.013, 934.012	04.03 -	OM 541.947		4000.90.17	400 18	- Engine code: OM 541
2046 AK 932.083	04.03 -	OM 541.948		4022.10.00	MFZ2/400X	- Vehicles with double disc clutch
2046 S 934.013, 934.012	04.03 -	OM 541.948		4025.30.00	400WGTZ	- GBox: Powershift
2048 AK 932.083	04.03 -	OM 541.972				
2048 S 934.013, 934.012	04.03 -	OM 541.974				
2048 AK 932.083	04.03 -	OM 541.976				
2048 AS 934.082	04.03 -	OM 541.980				
2035 A 950.083	04.97 - 10.02	OM 541.923		4300.90.15 ⊕	430 18	- Engine code: OM 541
2040 950.014	09.96 - 10.02	OM 541.924		4329.60.00	MFZ430	- Vehicles with single clutch disc
2040 AK 952.083	09.96 - 10.02	OM 541.927		4318.30.00	430WGTZ	
2040 AS 954.082	04.96 - 10.02	OM 541.943		4300.90.90 ⊕	430 18	- Engine code: OM 541
2040 S 954.012	04.96 - 10.02			4340.60.00	MFZ430	- Vehicles with single clutch disc
				4350.30.00	430WGTZ	- Equipment Var: SA 504682-22/24
				4350.30.00	430 18	- Engine code: OM 541
					430WGTZ	- For PTO
						- Vehicles with single clutch disc
				4000.90.04	400 18	
				4025.10.00	MFZ2/400X	
				4025.30.00	400WGTZ	
				4000.90.17	400 18	- Engine code: OM 541
				4022.10.00	MFZ2/400X	- Vehicles with double disc clutch
				4025.30.00	400WGTZ	- GBox: Powershift

Vehicle list

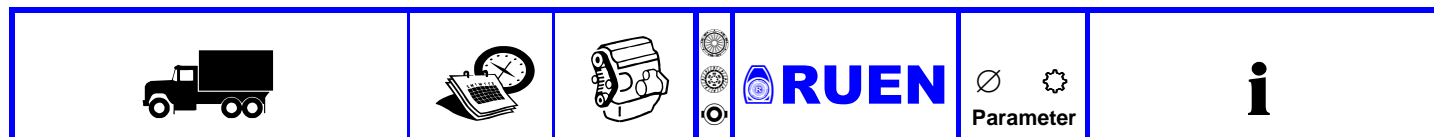

MERCEDES-BENZ

ACTROS 2031 - 2054		04.96 -				
2050 S 934.013, 934.012 2051 AS 934.082	04.03 -	OM 542.940	4300.90.381 ⊕	430 18	- Engine code: OM 542	
	04.03 -	OM 542.941	4329.60.00	MFZ430	- Vehicles with single clutch disc	
		OM 542.960	4351.30.00	430WGTZ		
			4000.90.04	400 18	- Engine code: OM 542	
			4025.10.00	MFZ2/400X	- Vehicles with double disc clutch	
			4025.30.00	400WGTZ		
			4000.90.17	400 18	- Engine code: OM 542	
			4022.10.00	MFZ2/400X	- Vehicles with double disc clutch	
			4025.30.00	400WGTZ	- GBox: Powershift	
2053 S 954.012	04.96 - 10.02	OM 542.920	4300.90.381 ⊕	430 18	- Engine code: OM 542	
			4329.60.00	MFZ430	- Vehicles with single clutch disc	
			4351.30.00	430WGTZ		
			4000.90.04	400 18	- Engine code: OM 542	
			4025.10.00	MFZ2/400X	- Vehicles with double disc clutch	
			4025.30.00	400WGTZ		
			4000.90.17	400 18	- Engine code: OM 542	
			4022.10.00	MFZ2/400X	- Vehicles with double disc clutch	
			4025.30.00	400WGTZ	- GBox: Powershift	
2031 950.013, 950.014, 950.016	04.97 - 10.02	OM 541.920	4300.90.15 ⊕	430 18	- Engine code: OM 541	
	04.03 -	OM 541.921	4329.60.00	MFZ430	- Vehicles with single clutch disc	
	04.03 -	OM 541.922	4318.30.00	430WGTZ		
2032 930.014, 930.013, 930.016	04.03 -	OM 541.923	4300.90.90 ⊕	430 18	- Engine code: OM 541	
			4340.60.00	MFZ430	- Vehicles with single clutch disc	
			4350.30.00	430WGTZ	- Equipment Var: SA 504682-22/24	
2032 A, AE 930.083	04.03 -	OM 541.925				
2035 S 954.012	04.03 -	OM 541.926				
2036 930.014, 930.013, 930.016	04.03 -	OM 541.927				
2036 A, AE 930.083	04.03 -	OM 541.940	4350.30.00	430 18	- Engine code: OM 541	
2036 K 932.013	04.03 -	OM 541.941		430WGTZ	- For PTO	
2040 930.014, 930.013, 930.016	10.02 -	OM 541.942			- Vehicles with single clutch disc	
2041 930.014, 930.013	04.03 -	OM 541.941				
2043 AS 954.082	04.03 -	OM 541.942	4000.90.04	400 18	- Engine code: OM 541	
2044 930.014, 930.013	04.96 - 10.02	OM 541.943	4025.10.00	MFZ2/400X	- Vehicles with double disc clutch	
2044 K 932.013	04.03 -	OM 541.944	4025.30.00	400WGTZ		
2046 930.014, 930.013	04.03 -	OM 541.946				
2046 AS 954.082	04.03 -	OM 541.947	4000.90.17	400 18	- Engine code: OM 541	
2046 AS 954.082	10.96 -	OM 541.948	4022.10.00	MFZ2/400X	- Vehicles with double disc clutch	
2046 AS 934.082	04.03 -	OM 541.948	4025.30.00	400WGTZ	- GBox: Powershift	
2046 K 932.013	04.03 -	OM 541.949				
2048 AS 934.082	04.03 -	OM 541.972				
2048 AS 934.082	04.03 -	OM 541.974				
2048 K 932.013	04.03 -	OM 541.976				
		OM 541.978				
		OM 541.980				
		OM 541.992				
		OM 541.994				
		OM 541.998				
		OM 542.925				
2048 AS 954.082	04.96 - 10.02	OM 542.925	4300.90.381 ⊕	430 18	- Engine code: OM 542	
	10.96 -	OM 542.941	4329.60.00	MFZ430	- Vehicles with double disc clutch	
	04.03 -	OM 542.942	4351.30.00	430WGTZ		
2050 AS 954.082			4000.90.04	400 18	- Engine code: OM 542	
			4025.10.00	MFZ2/400X	- Vehicles with double disc clutch	
			4025.30.00	400WGTZ		
2054 S 934.012			4000.90.17	400 18	- Engine code: OM 542	
			4022.10.00	MFZ2/400X	- Vehicles with double disc clutch	
			4025.30.00	400WGTZ	- GBox: Powershift	

Vehicle list



MERCEDES-BENZ

ACTROS 2432 - 2460 06.08 -

2432 LS	06.08 -	OM 541.970	4300.90.15 ⊕	430 18	- Engine code: OM 541 - Vehicles with single clutch disc
2432 LS 934.235	06.08 -	OM 541.972	4329.60.00	MFZ430	
2436 LS	06.08 -	OM 541.974	4318.30.00	430WGTZ	
2436 LS 934.235	06.08 -	OM 541.976	4300.90.90 ⊕	430 18	- Engine code: OM 541 - Vehicles with single clutch disc - Equipment Var: SA 504682-22/24
2441 LS	06.08 -	OM 541.978	4340.60.00	MFZ430	
2441 LS 934.235	06.08 -	OM 541.980	4350.30.00	430WGTZ	
2444 LS	06.08 -	OM 541.990	4350.30.00	430 18	- Engine code: OM 541 - For PTO - Vehicles with single clutch disc
2444 LS 934.235	06.08 -	OM 541.992	4000.90.04	400 18	- Engine code: OM 541 - Vehicles with double disc clutch
2446 LS	06.08 -	OM 541.994	4025.10.00	MFZ2/400X	
2446 LS 934.235	06.08 -	OM 541.996	4025.30.00	400WGTZ	
2448 LS	06.08 -	OM 541.998	4000.90.17	400 18	- Engine code: OM 541 - Vehicles with double disc clutch - GBox: Powershift
2448 LS 934.235	06.08 -		4022.10.00	MFZ2/400X	
			4025.30.00	400WGTZ	
2451 LS	06.08 -	OM 542.960	4300.90.381 ⊕	430 18	- Engine code: OM 542 - Vehicles with single clutch disc
2451 LS 934.235	06.08 -	OM 542.962	4329.60.00	MFZ430	
2455 LS	06.08 -		4351.30.00	430WGTZ	
2455 LS 934.235	06.08 -		4000.90.04	400 18	- Engine code: OM 542 - Vehicles with double disc clutch
			4025.10.00	MFZ2/400X	
			4025.30.00	400WGTZ	
			4000.90.17	400 18	- Engine code: OM 542 - Vehicles with double disc clutch - GBox: Powershift
			4022.10.00	MFZ2/400X	
			4025.30.00	400WGTZ	
2460 LS	06.08 -	OM 542.964	4300.90.382 ⊕	430 18	- Engine code: OM 542 - Vehicles with single clutch disc
2460 LS 934.235	06.08 -		4349.60.00	MFZ430	
			4352.30.00	430WGTZ	
			4000.90.04	400 18	- Engine code: OM 542 - Vehicles with double disc clutch
			4025.10.00	MFZ2/400X	
			4025.30.00	400WGTZ	
			4000.90.17	400 18	- Engine code: OM 542 - Vehicles with double disc clutch - GBox: Powershift
			4022.10.00	MFZ2/400X	
			4025.30.00	400WGTZ	

ACTROS 2531 - 2557 06.96 -

2531,2531 L 950.224, 950.225, 950.114, 950.204, 950.203, 950.205, 950.208, 950.226	09.96 - 10.02	OM 541.920 OM 541.940	4300.90.15 ⊕	430 18	- Engine code: OM 541 - Vehicles with single clutch disc
			4329.60.00	MFZ430	
			4318.30.00	430WGTZ	
			4300.90.90 ⊕	430 18	- Engine code: OM 541 - Vehicles with single clutch disc - Equipment Var: SA 504682-22/24
			4340.60.00	MFZ430	
			4350.30.00	430WGTZ	
			4350.30.00	430 18	- Engine code: OM 541 - For PTO - Vehicles with single clutch disc
			4000.90.04	400 18	- Engine code: OM 541 - Vehicles with double disc clutch
			4025.10.00	MFZ2/400X	
			4025.30.00	400WGTZ	
			4000.90.17	400 18	- Engine code: OM 541 - Vehicles with double disc clutch - GBox: Powershift
			4022.10.00	MFZ2/400X	
			4025.30.00	400WGTZ	
			4300.90.50 ⊕	430 18	
			4318.60.00	MFZ430	
			4318.30.00	430WGTZ	

Vehicle list

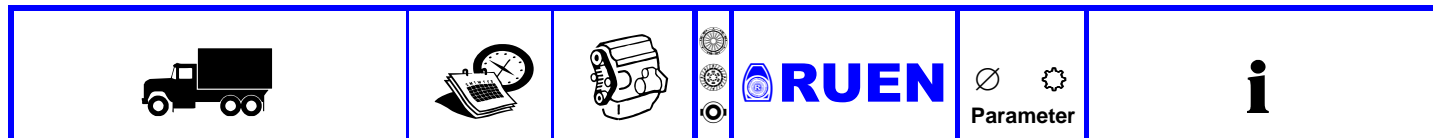

MERCEDES-BENZ

ACTROS 2531 - 2557

06.96 -

2531 LS 954.223 2543 LS 954.223, 954.233	09.96 - 10.02 09.96 - 10.02	OM 541.920 OM 541.925 OM 541.946	4300.90.15 ⊕	430 18	- Engine code: OM 541 - Vehicles with single clutch disc
			4329.60.00	MFZ430	
			4318.30.00	430WGTZ	
			4300.90.90 ⊕	430 18	- Engine code: OM 541 - Vehicles with single clutch disc - Equipment Var: SA 504682-22/24
			4340.60.00	MFZ430	
			4350.30.00	430WGTZ	
			4350.30.00	430 18	- Engine code: OM 541 - For PTO - Vehicles with single clutch disc
			4000.90.04	400 18	- Engine code: OM 541 - Vehicles with double disc clutch
			4025.10.00	MFZ2/400X	
			4025.30.00	400WGTZ	
			4000.90.17	400 18	- Engine code: OM 541 - Vehicles with double disc clutch - GBox: Powershift
			4022.10.00	MFZ2/400X	
			4025.30.00	400WGTZ	
2532 LS 934.233, 934.223 2536 LS 934.233, 934.223 2541 LS 934.233, 934.223 2544 LS 934.233, 934.223 2546 LS 934.233, 934.223 2548 LS 934.233, 934.223, 11946cc	04.03 - 04.03 - 04.03 - 04.03 - 04.03 - 04.03 -	OM 541.922 OM 541.940 OM 541.942 OM 541.943 OM 541.944 OM 541.946 OM 541.948 OM 541.976 OM 541.978 OM 541.980	4300.90.15 ⊕	430 18	- Engine code: OM 541 - Vehicles with single clutch disc
			4329.60.00	MFZ430	
			4318.30.00	430WGTZ	
			4300.90.90 ⊕	430 18	- Engine code: OM 541 - Vehicles with single clutch disc - Equipment Var: SA 504682-22/24
			4340.60.00	MFZ430	
			4350.30.00	430WGTZ	
			4350.30.00	430 18	- Engine code: OM 541 - For PTO - Vehicles with single clutch disc
			4000.90.04	400 18	- Engine code: OM 541 - Vehicles with double disc clutch
			4025.10.00	MFZ2/400X	
			4025.30.00	400WGTZ	
			4000.90.17	400 18	- Engine code: OM 541 - Vehicles with double disc clutch - GBox: Powershift
			4022.10.00	MFZ2/400X	
			4025.30.00	400WGTZ	
2535 L 950.224, 950.225, 950.213, 950.204, 950.203, 950.205, 950.214, 950.218, 950.208, 950.223, 950.226	09.96 - 10.02	OM 541.922 OM 541.942	4300.90.15 ⊕	430 18	- Engine code: OM 541 - Vehicles with single clutch disc
			4329.60.00	MFZ430	
			4318.30.00	430WGTZ	
			4300.90.90 ⊕	430 18	- Engine code: OM 541 - Vehicles with single clutch disc - Equipment Var: SA 504682-22/24
			4340.60.00	MFZ430	
			4350.30.00	430WGTZ	
			4350.30.00	430 18	- Engine code: OM 541 - For PTO - Vehicles with single clutch disc
			4000.90.04	400 18	- Engine code: OM 541 - Vehicles with double disc clutch
			4025.10.00	MFZ2/400X	
			4025.30.00	400WGTZ	
			4000.90.17	400 18	- Engine code: OM 541 - Vehicles with double disc clutch - GBox: Powershift
			4022.10.00	MFZ2/400X	
			4025.30.00	400WGTZ	
			4300.90.50 ⊕	430 18	
			4318.60.00	MFZ430	
			4318.30.00	430WGTZ	

Vehicle list

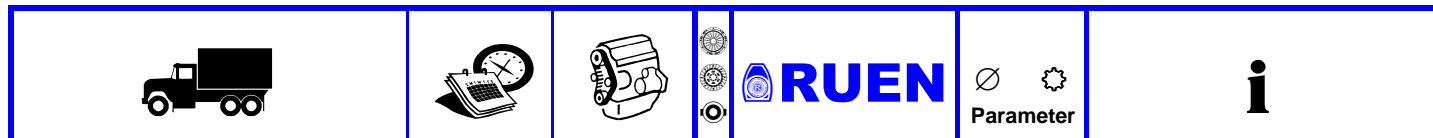







MERCEDES-BENZ

ACTROS 2531 - 2557





























06.96 -

2535 LS 954.223, 954.233 2540 LS 954.223, 954.233	09.96 - 10.02 09.96 - 10.02	OM 541.922	4300.90.15 ⊕	430 18	- Engine code: OM 541
		OM 541.923	4329.60.00	MFZ430	- Vehicles with single clutch disc
		OM 541.942	4318.30.00	430WGTZ	
		OM 541.944	4300.90.90 ⊕	430 18	- Engine code: OM 541
			4340.60.00	MFZ430	- Vehicles with single clutch disc
	4350.30.00	430WGTZ	- Equipment Var: SA 504682-22/24		
			4350.30.00	430 18	- Engine code: OM 541
			4000.90.04	400 18	- For PTO
			4025.10.00	MFZ2/400X	- Vehicles with single clutch disc
			4025.30.00	400WGTZ	- Vehicles with double disc clutch
			4000.90.17	400 18	- Engine code: OM 541
			4022.10.00	MFZ2/400X	- Vehicles with double disc clutch
			4025.30.00	400WGTZ	- GBox: Powershift
2540,2540 L 950.113, 950.213, 950.114, 950.204, 950.203, 950.205, 950.214, 950.218, 950.208	09.96 - 10.02	OM 541.923	4300.90.15 ⊕	430 18	- Engine code: OM 541
		OM 541.944	4329.60.00	MFZ430	- Vehicles with single clutch disc
			4318.30.00	430WGTZ	
			4300.90.90 ⊕	430 18	- Engine code: OM 541
			4340.60.00	MFZ430	- Vehicles with single clutch disc
	4350.30.00	430WGTZ	- Equipment Var: SA 504682-22/24		
			4350.30.00	430 18	- Engine code: OM 541
			4000.90.04	400 18	- For PTO
			4025.10.00	MFZ2/400X	- Vehicles with single clutch disc
			4025.30.00	400WGTZ	- Vehicles with double disc clutch
			4000.90.17	400 18	- Engine code: OM 541
			4022.10.00	MFZ2/400X	- Vehicles with double disc clutch
			4025.30.00	400WGTZ	- GBox: Powershift
2543,2543 L 950.113, 950.213, 950.114, 950.204, 950.203, 950.205, 950.214, 950.208	09.96 - 10.02	OM 541.925	4300.90.15 ⊕	430 18	- Engine code: OM 541
		OM 541.946	4329.60.00	MFZ430	- Vehicles with single clutch disc
			4318.30.00	430WGTZ	
			4300.90.90 ⊕	430 18	- Engine code: OM 541
			4340.60.00	MFZ430	- Vehicles with single clutch disc
	4350.30.00	430WGTZ	- Equipment Var: SA 504682-22/24		
			4350.30.00	430 18	- Engine code: OM 541
			4000.90.04	400 18	- For PTO
			4025.10.00	MFZ2/400X	- Vehicles with single clutch disc
			4025.30.00	400WGTZ	- Vehicles with double disc clutch
			4000.90.17	400 18	- Engine code: OM 541
			4022.10.00	MFZ2/400X	- Vehicles with double disc clutch
			4025.30.00	400WGTZ	- GBox: Powershift
2548,2548 L 950.113, 950.114, 950.204, 950.203, 950.205 2553,2553 L 950.113, 950.114, 950.204, 950.203, 950.205	09.96 - 10.02	OM 542.920	4300.90.381 ⊕	430 18	- Engine code: OM 542
	09.96 - 10.02	OM 542.921	4329.60.00	MFZ430	- Vehicles with single clutch disc
			4351.30.00	430WGTZ	
			4000.90.04	400 18	- Engine code: OM 542
			4025.10.00	MFZ2/400X	- Vehicles with double disc clutch
			4025.30.00	400WGTZ	
			4000.90.17	400 18	- Engine code: OM 542
			4022.10.00	MFZ2/400X	- Vehicles with double disc clutch
			4025.30.00	400WGTZ	- GBox: Powershift

Vehicle list

					
---	---	---	--	---	---

MERCEDES-BENZ

ACTROS 2531 - 2557		06.96 -				
2548 LS 954.223, 954.233, 15928cc	09.96 - 10.02	OM 542.920		4300.90.381 ⊕	430 18	- Engine code: OM 542 - Vehicles with single clutch disc
2553 LS 954.223, 954.233	09.96 - 10.02	OM 542.921		 4329.60.00	MFZ430	
				 4351.30.00	430WGTZ	
				4000.90.04	400 18	- Engine code: OM 542 - Vehicles with double disc clutch
			 4025.10.00	MFZ2/400X		
			 4025.30.00	400WGTZ		
				4000.90.17	400 18	- Engine code: OM 542 - Vehicles with double disc clutch - GBox: Powershift
			 4022.10.00	MFZ2/400X		
			 4025.30.00	400WGTZ		
2557 L 950.203	09.96 - 10.02	OM 542.922		4300.90.382 ⊕	430 18	- Engine code: OM 542 - Vehicles with single clutch disc
				 4349.60.00	MFZ430	
				 4352.30.00	430WGTZ	
				4000.90.04	400 18	- Engine code: OM 542 - Vehicles with double disc clutch
			 4025.10.00	MFZ2/400X		
			 4025.30.00	400WGTZ		
				4000.90.17	400 18	- Engine code: OM 542 - Vehicles with double disc clutch - GBox: Powershift
			 4022.10.00	MFZ2/400X		
			 4025.30.00	400WGTZ		
2531 930.224, 930.113, 930.214, 930.225, 930.226, 930.114, 930.213, 930.215	09.96 -	OM 501 LA OM 541.920		4300.90.15 ⊕	430 18	- Engine code: OM 541 - Vehicles with single clutch disc
2531 930.204, 930.205, 930.208, 930.202, 930.203	09.96 -	OM 541.922 OM 541.923		 4329.60.00	MFZ430	
2531 LS 954.223	09.96 - 10.02	OM 541.925	 4300.90.90 ⊕	430 18	- Engine code: OM 541 - Vehicles with single clutch disc - Equipment Var: SA 504682-22/24	
2531,2531 L 950.224, 950.225, 950.114, 950.204, 950.203, 950.205, 950.208, 950.226	09.96 - 10.02	OM 541.940 OM 541.942	 4340.60.00	MFZ430		
2532 L 930.206, 930.201	01.03 -	OM 541.943 OM 541.944	 4350.30.00	430 18	- Engine code: OM 541 - For PTO - Vehicles with single clutch disc	
2532 LS 934.233, 934.223	04.03 -	OM 541.946		4000.90.04	400 18	- Engine code: OM 541 - Vehicles with double disc clutch
2532, L, LL	04.03 -	OM 541.948 OM 541.970	 4025.10.00	MFZ2/400X		
	04.03 -	OM 541.972	 4025.30.00	400WGTZ		
2535 L 950.224, 950.225, 950.213, 950.204, 950.203, 950.205, 950.214, 950.218, 950.208, 950.223, 950.226	09.96 - 10.02	OM 541.974 OM 541.976		4000.90.17	400 18	- Engine code: OM 541 - Vehicles with double disc clutch - GBox: Powershift
2536 LS 934.233, 934.223	04.03 -	OM 541.978	 4022.10.00	MFZ2/400X		
2536, L, LL	04.03 -	OM 541.980	 4025.30.00	400WGTZ		
	04.03 -	OM 541.990				
2541 L 930.206, 930.201	01.03 -	OM 541.992				
2541 LS 934.233, 934.223	04.03 -	OM 541.994				
2541 LS	06.08 -	OM 541.996				
2541, L, LL	04.03 -	OM 541.998				
	04.03 -					
2544 L 930.206, 930.201	01.03 -					
2544 LS 934.233, 934.223, 315kW	04.03 -					
2544 LS	06.08 -					
2544, L, LL	04.03 -					
	04.03 -					
2546 L 930.206, 930.201	01.03 -					
2546 LS 954.223	10.97 -					
2546 LS 934.233, 934.223	04.03 -					
2546, L, LL	04.03 -					
	04.03 -					
2548 LS 934.233, 934.223	04.03 -					
2548, L, LL 930.204, 930.113, 930.205, 930.208, 930.214, 930.206, 930.218, 930.114, 930.202, 930.201, 930.203, 930.213, 930.215	04.03 -					
	04.03 -					

Vehicle list

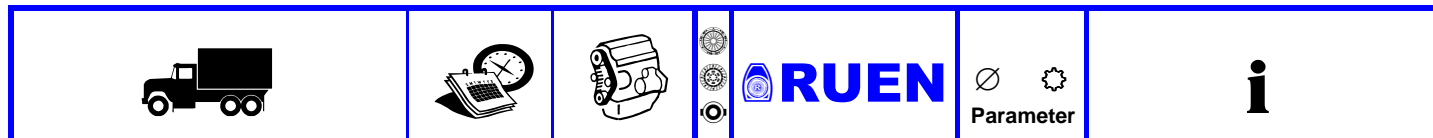

MERCEDES-BENZ

ACTROS 2531 - 2557

06.96 -

2548 L 930.204, 930.205, 930.202, 930.203 2550 LS 934.233	04.03 -	OM 541.921	4300.90.381 ⊕	430 18	- Engine code: OM 542 - Vehicles with single clutch disc
	04.03 -	OM 541.940	4329.60.00	MFZ430	
	04.03 -	OM 542.920	4351.30.00	430WGTZ	
2551 LS 934.233, 934.223 2551, L, LL 930.204, 930.113, 930.205, 930.206, 930.114, 930.202, 930.201, 930.203	04.03 -	OM 542.940	4000.90.04	400 18	- Engine code: OM 542 - Vehicles with double disc clutch
	04.03 -	OM 542.942	4025.10.00	MFZ2/400X	
	04.03 -	OM 542.960	4025.30.00	400WGTZ	
2553 L 930.204, 930.205, 930.202, 930.203 2554 LS 934.233, 934.223 2554, L 930.113 2555 LS 934.233, 934.223 2555, L, LL 930.204, 930.113, 930.205, 930.206, 930.114, 930.202, 930.201, 930.203	04.03 -	OM 542.962	4000.90.17	400 18	- Engine code: OM 542 - Vehicles with double disc clutch - GBox: Powershift
	04.03 -		4022.10.00	MFZ2/400X	
	04.03 -		4025.30.00	400WGTZ	
2558, L 930.203 2560, L, LL 930.204, 930.205, 930.202, 930.201, 930.203	04.03 -	OM 542.944	4300.90.382 ⊕	430 18	- Engine code: OM 542 - Vehicles with single clutch disc
	04.03 -	OM 542.964	4349.60.00	MFZ430	
	04.03 -		4352.30.00	430WGTZ	
	04.03 -		4000.90.04	400 18	- Engine code: OM 542 - Vehicles with double disc clutch
			4025.10.00	MFZ2/400X	
			4025.30.00	400WGTZ	
	04.03 -		4000.90.17	400 18	- Engine code: OM 542 - Vehicles with double disc clutch - GBox: Powershift
			4022.10.00	MFZ2/400X	
			4025.30.00	400WGTZ	

ACTROS 2631 - 2665

04.96 -

2631 B 953.141 2631,2631 L 950.244, 950.143, 950.145, 950.243, 950.242, 950.142	04.97 - 10.02	OM 541.920	4300.90.15 ⊕	430 18	- Engine code: OM 541 - Vehicles with single clutch disc
	04.96 - 10.02		4329.60.00	MFZ430	
			4318.30.00	430WGTZ	
			4300.90.90 ⊕	430 18	- Engine code: OM 541 - Vehicles with single clutch disc - Equipment Var: SA 504682-22/24
			4340.60.00	MFZ430	
			4350.30.00	430WGTZ	
			4350.30.00	430 18	- Engine code: OM 541 - For PTO - Vehicles with single clutch disc
	04.96 - 10.02		4000.90.04	400 18	- Engine code: OM 541 - Vehicles with double disc clutch
			4025.10.00	MFZ2/400X	
			4025.30.00	400WGTZ	
			4000.90.17	400 18	- Engine code: OM 541 - Vehicles with double disc clutch - GBox: Powershift
			4022.10.00	MFZ2/400X	
			4025.30.00	400WGTZ	
	04.96 - 10.02		4300.90.50 ⊕	430 18	
			4318.60.00	MFZ430	
			4318.30.00	430WGTZ	

Vehicle list



MERCEDES-BENZ

ACTROS 2631 - 2665		04.96 -				
2631 K 952.141, 952.143, 952.142	04.97 - 10.02	OM 541.920		4300.90.15 ⊕	430 18	- Engine code: OM 541
2635 K, 2635 LK 952.141, 952.143, 952.241	04.97 - 10.02	OM 541.922		4329.60.00	MFZ430	- Vehicles with single clutch disc
2640 K, 2640 LK 952.141, 952.143, 952.243, 952.241	04.97 - 10.02	OM 541.923		4318.30.00	430WGTZ	
2643 K, 2643 LK 2643 K, 2643 LK	04.97 - 10.02	OM 541.925		4300.90.90 ⊕	430 18	- Engine code: OM 541
				4340.60.00	MFZ430	- Vehicles with single clutch disc
				4350.30.00	430WGTZ	- Equipment Var: SA 504682-22/24
				4350.30.00	430 18	- Engine code: OM 541
				4000.90.04	430WGTZ	- For PTO
				4000.90.04	400 18	- Vehicles with single clutch disc
				4025.10.00	MFZ2/400X	- Engine code: OM 541
				4025.30.00	400WGTZ	- Vehicles with double disc clutch
				4000.90.17	400 18	- Engine code: OM 541
				4022.10.00	MFZ2/400X	- Vehicles with double disc clutch
				4025.30.00	400WGTZ	- GBox: Powershift
2632 K, LK 932.141, 932.143, 932.142, 932.145, 932.241	04.03 -	OM 541.940		4300.90.15 ⊕	430 18	- Engine code: OM 541
2632 LS 934.241	04.03 -	OM 541.942		4329.60.00	MFZ430	- Vehicles with single clutch disc
2636 K, LK 932.141, 932.143, 932.142, 932.145, 932.241	04.03 -	OM 541.944		4318.30.00	430WGTZ	
2636 LS 934.241	04.03 -	OM 541.946		4300.90.90 ⊕	430 18	- Engine code: OM 541
2641 K, LK 932.141, 932.143, 932.142, 932.145, 932.241	04.03 -	OM 541.948		4340.60.00	MFZ430	- Vehicles with single clutch disc
2641 S, LS 934.141, 934.241	04.03 -	OM 541.970		4350.30.00	430WGTZ	- Equipment Var: SA 504682-22/24
2644 K, LK 932.141, 932.143, 932.142, 932.145, 932.241	04.03 -	OM 541.972		4350.30.00	430 18	- Engine code: OM 541
2644 S, LS 934.141, 934.241	04.03 -	OM 541.974		4000.90.04	430WGTZ	- For PTO
2646 K, LK 932.141, 932.143, 932.142, 932.145, 932.241	04.03 -	OM 541.976		4000.90.04	400 18	- Engine code: OM 541
2646 S, LS 954.241, 954.141	04.03 -	OM 541.980		4025.10.00	MFZ2/400X	- Vehicles with double disc clutch
				4025.30.00	400WGTZ	
				4000.90.17	400 18	- Engine code: OM 541
				4022.10.00	MFZ2/400X	- Vehicles with double disc clutch
				4025.30.00	400WGTZ	- GBox: Powershift
2632, L, LL 930.244, 930.142, 930.145, 930.143, 930.243, 930.242	04.03 -	OM 541.940		4300.90.15 ⊕	430 18	- Engine code: OM 541
2636, L, LL 930.244, 930.142, 930.143, 930.243, 930.242	04.03 -	OM 541.942		4329.60.00	MFZ430	- Vehicles with single clutch disc
2641, L, LL 930.244, 930.143, 930.243, 930.242	04.03 -	OM 541.944		4318.30.00	430WGTZ	
2644, L, LL 930.244, 930.142, 930.143, 930.243, 930.242	04.03 -	OM 541.946		4300.90.90 ⊕	430 18	- Engine code: OM 541
2646, L, LL 930.244, 930.142, 930.145, 930.143, 930.243, 930.242	04.03 -	OM 541.948		4340.60.00	MFZ430	- Vehicles with single clutch disc
				4350.30.00	430WGTZ	- Equipment Var: SA 504682-22/24
				4350.30.00	430 18	- Engine code: OM 541
				4000.90.04	430WGTZ	- For PTO
				4000.90.04	400 18	- Engine code: OM 541
				4025.10.00	MFZ2/400X	- Vehicles with double disc clutch
				4025.30.00	400WGTZ	
				4000.90.17	400 18	- Engine code: OM 541
				4022.10.00	MFZ2/400X	- Vehicles with double disc clutch
				4025.30.00	400WGTZ	- GBox: Powershift

Vehicle list

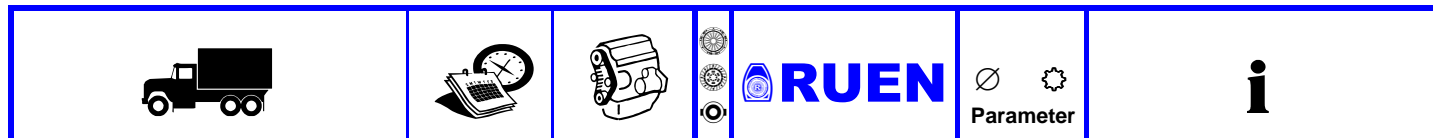

MERCEDES-BENZ

ACTROS 2631 - 2665

04.96 -

2635 B 953.141 2635,2635 L 950.244, 950.143, 950.243 950.142	04.97 - 10.02 04.96 - 10.02	OM 541.922	4300.90.15 ⊕ 4329.60.00 4318.30.00	430 18 MFZ430 430WGTZ	- Engine code: OM 541 - Vehicles with single clutch disc
			4300.90.90 ⊕ 4340.60.00 4350.30.00	430 18 MFZ430 430WGTZ	- Engine code: OM 541 - Vehicles with single clutch disc - Equipment Var: SA 504682-22/24
			4350.30.00	430 18 430WGTZ	- Engine code: OM 541 - For PTO - Vehicles with single clutch disc
			4000.90.04 4025.10.00 4025.30.00	400 18 MFZ2/400X 400WGTZ	- Engine code: OM 541 - Vehicles with double disc clutch
			4000.90.17 4022.10.00 4025.30.00	400 18 MFZ2/400X 400WGTZ	- Engine code: OM 541 - Vehicles with double disc clutch - GBox: Powershift
			4300.90.50 ⊕ 4318.60.00 4318.30.00	430 18 MFZ430 430WGTZ	
2640 B 953.141 2640,2640 L 950.244, 950.143, 950.243 950.242 2643 B 953.141 2643,2643 L 950.244, 950.143, 950.243 950.242	04.97 - 10.02 04.96 - 10.02 04.97 - 10.02 04.96 - 10.02	OM 541.923 OM 541.925	4300.90.15 ⊕ 4329.60.00 4318.30.00	430 18 MFZ430 430WGTZ	- Engine code: OM 541 - Vehicles with single clutch disc
			4300.90.90 ⊕ 4340.60.00 4350.30.00	430 18 MFZ430 430WGTZ	- Engine code: OM 541 - Vehicles with single clutch disc - Equipment Var: SA 504682-22/24
			4350.30.00	430 18 430WGTZ	- Engine code: OM 541 - For PTO - Vehicles with single clutch disc
			4000.90.04 4025.10.00 4025.30.00	400 18 MFZ2/400X 400WGTZ	- Engine code: OM 541 - Vehicles with double disc clutch
			4000.90.17 4022.10.00 4025.30.00	400 18 MFZ2/400X 400WGTZ	- Engine code: OM 541 - Vehicles with double disc clutch - GBox: Powershift
2640 S,2640 LS 954.241, 954.141 2643 S,2643 LS 954.241, 954.141	09.96 - 10.02 04.97 - 10.02	OM 541.923 OM 541.925	4300.90.15 ⊕ 4329.60.00 4318.30.00	430 18 MFZ430 430WGTZ	- Engine code: OM 541 - Vehicles with single clutch disc
			4300.90.90 ⊕ 4340.60.00 4350.30.00	430 18 MFZ430 430WGTZ	- Engine code: OM 541 - Vehicles with single clutch disc - Equipment Var: SA 504682-22/24
			4350.30.00	430 18 430WGTZ	- Engine code: OM 541 - For PTO - Vehicles with single clutch disc
			4000.90.04 4025.10.00 4025.30.00	400 18 MFZ2/400X 400WGTZ	- Engine code: OM 541 - Vehicles with double disc clutch
			4000.90.17 4022.10.00 4025.30.00	400 18 MFZ2/400X 400WGTZ	- Engine code: OM 541 - Vehicles with double disc clutch - GBox: Powershift

Vehicle list



MERCEDES-BENZ

ACTROS 2631 - 2665		04.96 -				
2648 K, 2648 LK 952.141, 952.143, 952.243, 952.241 2653 K, 2653 LK 952.141, 952.143, 952.243, 952.241	04.97 - 10.02	OM 542.920	4300.90.381 ⊕ 4329.60.00 4351.30.00	430 18 MFZ430 430WGTZ	- Engine code: OM 542 - Vehicles with single clutch disc	
	04.97 - 10.02	OM 542.921	4000.90.04 4025.10.00 4025.30.00	400 18 MFZ2/400X 400WGTZ	- Engine code: OM 542 - Vehicles with double disc clutch	
			4000.90.17 4022.10.00 4025.30.00	400 18 MFZ2/400X 400WGTZ	- Engine code: OM 542 - Vehicles with double disc clutch - GBox: Powershift	
2648 S, 2648 LS 954.241, 954.141 2648, 2648 L 950.244, 950.143, 950.243, 950.242	09.96 - 10.02	OM 542.921	4300.90.381 ⊕ 4329.60.00 4351.30.00	430 18 MFZ430 430WGTZ	- Engine code: OM 542 - Vehicles with single clutch disc	
	04.96 - 10.02	OM 542.940	4000.90.04 4025.10.00 4025.30.00	400 18 MFZ2/400X 400WGTZ	- Engine code: OM 542 - Vehicles with double disc clutch	
			4000.90.17 4022.10.00 4025.30.00	400 18 MFZ2/400X 400WGTZ	- Engine code: OM 542 - Vehicles with double disc clutch - GBox: Powershift	
2650 K, 2651 K, LK 932.141, 932.143, 932.145, 932.241 2650 S, LS 934.141, 934.233, 934.223, 934.241 2654 K, LK, 2655 K, LK 932.141, 932.143, 932.145, 932.241 2654 S, LS 934.141, 934.233, 934.223, 934.241 2658 K, LK 932.141, 932.241 2658 L 930.243, 930.242 2658 LS 934.241	04.03 -	OM 542.940	4300.90.382 ⊕ 4349.60.00 4352.30.00	430 18 MFZ430 430WGTZ	- Engine code: OM 542 - Vehicles with single clutch disc	
	04.03 -	OM 542.942	4000.90.04 4025.10.00 4025.30.00	400 18 MFZ2/400X 400WGTZ	- Engine code: OM 542 - Vehicles with double disc clutch	
	04.03 -	OM 542.944				
04.03 -	OM 542.960	4000.90.17 4022.10.00 4025.30.00	400 18 MFZ2/400X 400WGTZ	- Engine code: OM 542 - Vehicles with double disc clutch - GBox: Powershift		
2650, L, 2651, L, LL 930.244, 930.142, 930.143, 930.243, 930.242 2654, L, 2655, L, LL 930.244, 930.142, 930.143, 930.243, 930.242	04.03 -	OM 542.940	4300.90.381 ⊕ 4329.60.00 4351.30.00	430 18 MFZ430 430WGTZ	- Engine code: OM 542 - Vehicles with single clutch disc	
	04.03 -	OM 542.942	4000.90.04 4025.10.00 4025.30.00	400 18 MFZ2/400X 400WGTZ	- Engine code: OM 542 - Vehicles with double disc clutch	
			4000.90.17 4022.10.00 4025.30.00	400 18 MFZ2/400X 400WGTZ	- Engine code: OM 542 - Vehicles with double disc clutch - GBox: Powershift	

Vehicle list



MERCEDES-BENZ

ACTROS 2631 - 2665 04.96 -

2653 950.143, 950.243, 954.141	01.96 -		4300.90.15 ⊕ 4329.60.00 4318.30.00	430 18 MFZ430 430WGTZ	- Engine code: OM 541 - Vehicles with single clutch disc
			4300.90.90 ⊕ 4340.60.00 4350.30.00	430 18 MFZ430 430WGTZ	- Engine code: OM 541 - Vehicles with single clutch disc - Equipment Var: SA 504682-22/24
			4350.30.00	430 18 430WGTZ	- Engine code: OM 541 - For PTO - Vehicles with single clutch disc
			4000.90.04 4025.10.00 4025.30.00	400 18 MFZ2/400X 400WGTZ	- Engine code: OM 541 - Vehicles with double disc clutch
			4000.90.17 4022.10.00 4025.30.00	400 18 MFZ2/400X 400WGTZ	- Engine code: OM 541 - Vehicles with double disc clutch - GBox: Powershift
			4000.90.03 4010.10.00 4021.30.00 8928.40.00	400 10 MFZ2/400X 400GVZ KZIZ - 5	
2653,2653 L 950.143, 950.243 2653 S,2653 LS 954.241, 954.141	04.96 - 10.02 09.96 - 10.02	OM 542.920	4300.90.381 ⊕ 4329.60.00 4351.30.00	430 18 MFZ430 430WGTZ	- Engine code: OM 542 - Vehicles with single clutch disc
			4000.90.04 4025.10.00 4025.30.00	400 18 MFZ2/400X 400WGTZ	- Engine code: OM 542 - Vehicles with double disc clutch
			4000.90.17 4022.10.00 4025.30.00	400 18 MFZ2/400X 400WGTZ	- Engine code: OM 542 - Vehicles with double disc clutch - GBox: Powershift
2657 K,2657 LK 952.141, 952.243, 952.241 2657 S, 2657 LS 954.241	04.97 - 10.02 04.97 - 10.02	OM 542.922	4300.90.382 ⊕ 4349.60.00 4352.30.00	430 18 MFZ430 430WGTZ	- Engine code: OM 542 - Vehicles with single clutch disc
			4000.90.04 4025.10.00 4025.30.00	400 18 MFZ2/400X 400WGTZ	- Engine code: OM 542 - Vehicles with double disc clutch
			4000.90.17 4022.10.00 4025.30.00	400 18 MFZ2/400X 400WGTZ	- Engine code: OM 542 - Vehicles with double disc clutch - GBox: Powershift
2657 L 950.243	04.97 - 10.02	OM 542.922	4300.90.382 ⊕ 4349.60.00 4352.30.00	430 18 MFZ430 430WGTZ	- Engine code: OM 542 - Vehicles with single clutch disc
			4000.90.04 4025.10.00 4025.30.00	400 18 MFZ2/400X 400WGTZ	- Engine code: OM 542 - Vehicles with double disc clutch
			4000.90.17 4022.10.00 4025.30.00	400 18 MFZ2/400X 400WGTZ	- Engine code: OM 542 - Vehicles with double disc clutch - GBox: Powershift
2631 932.241 2660 L, LL 930.243, 930.242 2660 LK 932.141, 932.241 2660 S, LS 934.241	09.96 - 05.05 - 04.03 - 06.08 -	OM 542.920 OM 542.964	4300.90.382 ⊕ 4349.60.00 4352.30.00	430 18 MFZ430 430WGTZ	- Engine code: OM 542 - Vehicles with single clutch disc
			4000.90.04 4025.10.00 4025.30.00	400 18 MFZ2/400X 400WGTZ	- Engine code: OM 542 - Vehicles with double disc clutch
			4000.90.17 4022.10.00 4025.30.00	400 18 MFZ2/400X 400WGTZ	- Engine code: OM 542 - Vehicles with double disc clutch - GBox: Powershift

Vehicle list

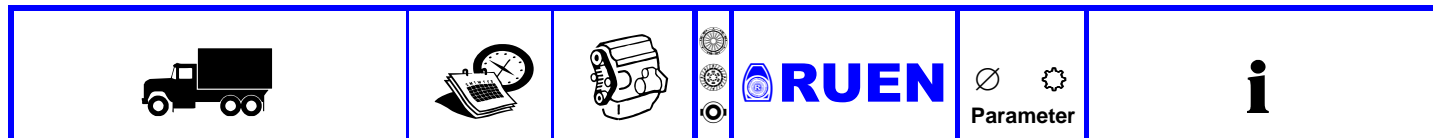

MERCEDES-BENZ

ACTROS 2631 - 2665

04.96 -

2631 B 933.141	04.03 -	OM 541.920	4300.90.15 ⊕	430 18	- Engine code: OM 541 - Vehicles with single clutch disc
2631 K, LK 932.141, 932.143, 932.142, 932.241	04.03 -	OM 541.922	4329.60.00	MFZ430	
2631 L 930.244, 930.243, 930.242	04.03 -	OM 541.923	4318.30.00	430WGTZ	
2631 LS 934.241	10.02 -	OM 541.925	4300.90.90 ⊕	430 18	- Engine code: OM 541 - Vehicles with single clutch disc
2631 LS 934.251	10.09 -	OM 541.940	4340.60.00	MFZ430	- Equipment Var: SA 504682-22/24
2632 B 933.141	04.03 -	OM 541.942	4350.30.00	430WGTZ	
2632 LS 934.251	10.09 -	OM 541.944	4350.30.00	430 18	- Engine code: OM 541 - For PTO
2635 B 953.141	04.03 -	OM 541.948		430WGTZ	- Vehicles with single clutch disc
2635 K, LK 932.141, 932.143, 932.142, 932.241	04.03 -	OM 541.970	4000.90.04	400 18	- Engine code: OM 541 - Vehicles with double disc clutch
2635 L 930.244, 930.243, 930.242	04.03 -	OM 541.972	4025.10.00	MFZ2/400X	
2635 LS 934.241	10.02 -	OM 541.974	4025.30.00	400WGTZ	
2635 LS 934.251	10.09 -	OM 541.976	4000.90.17	400 18	- Engine code: OM 541 - Vehicles with double disc clutch
2636 B 933.141	04.03 -	OM 541.978	4022.10.00	MFZ2/400X	- GBox: Powershift
2636 LS 934.251	10.09 -	OM 541.980	4025.30.00	400WGTZ	
2640 B 933.141	04.03 -	OM 541.992			
2640 K, LK 932.141, 932.143, 932.142, 932.241	04.03 -	OM 541.994			
2640 L 930.244, 930.243, 930.242	04.03 -	OM 541.996			
2640 LS 934.241	10.02 -	OM 541.998			
2640 LS 934.251	10.09 -				
2641 B 933.141	04.03 -				
2641 LS 934.251	10.09 -				
2643 B 933.141	04.03 -				
2643 K, LK 932.141, 932.143, 932.142, 932.241	04.03 -				
2643 L 930.244, 930.243, 930.242	04.03 -				
2643 LS 934.251	10.09 -				
2644 B 933.141	04.03 -				
2646 B 953.141	10.97 -				
2646 B 933.141	04.03 -				
2646 LS 934.251	10.09 -				
2648 B 933.141	04.03 -				
2648 K, 2648 LK 952.141, 952.143, 952.241	10.97 -				
2648 K, LK 932.141, 932.143, 932.142, 932.145, 932.241	04.03 -				
2648, L, LL 930.244, 930.142, 930.143, 930.243, 930.242	04.03 -				
2648 LS 934.251	10.09 -				
2648 S, 2648 LS 954.241, 954.141	10.97 -				
2648 S, LS 934.141, 934.241	04.03 -				
2648 K, LK 932.141, 932.143, 932.241	04.03 -	OM 542.920	4300.90.381 ⊕	430 18	- Engine code: OM 542 - Vehicles with single clutch disc
2648 L 930.244, 930.243, 930.242	04.03 -	OM 542.921	4329.60.00	MFZ430	
2648 LS 934.241	10.02 -	OM 542.940	4351.30.00	430WGTZ	
2650 S, 2650 LS 954.241, 954.141	10.97 -	OM 542.942	4000.90.04	400 18	- Engine code: OM 542 - Vehicles with double disc clutch
2651 L 930.244, 930.243	04.03 -	OM 542.960	4025.10.00	MFZ2/400X	
2651 LS 934.251	10.09 -	OM 542.962	4025.30.00	400WGTZ	
2653 K, LK 932.141, 932.143, 932.241	04.03 -		4000.90.17	400 18	- Engine code: OM 542 - Vehicles with double disc clutch
2653 L 930.244, 930.243, 930.242	04.03 -		4022.10.00	MFZ2/400X	- GBox: Powershift
2653 LS 934.251	10.09 -		4025.30.00	400WGTZ	
2655 LS 934.251	10.09 -				
2655 S, LS 934.141, 934.241	04.03 -				

Vehicle list

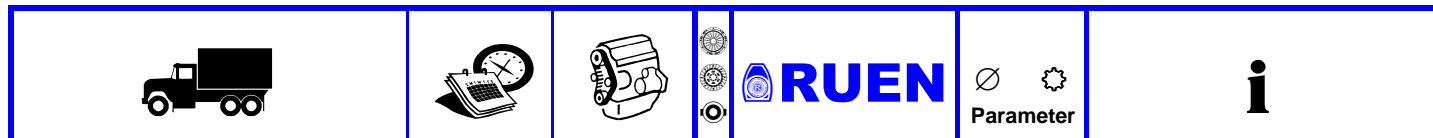

MERCEDES-BENZ

ACTROS 2631 - 2665		04.96 -				
2665 LS 934.241	04.03 -	OM 542.968	4000.90.04 4025.10.00 4025.30.00	400 18	MFZ2/400X 400WGTZ	- Engine code: OM 542
2665 LS	10.02 -	OM 542.969				- Vehicles with double disc clutch
			4000.90.17 4022.10.00 4025.30.00	400 18	MFZ2/400X 400WGTZ	- Engine code: OM 542
						- Vehicles with double disc clutch
						- GBox: Powershift
ACTROS 3231 - 3336		04.96 -				
3231 B 953.304	04.97 - 10.02	OM 541.920	4300.90.15 ⊕ 4329.60.00 4318.30.00	430 18	MFZ430 430WGTZ	- Engine code: OM 541
3235 B 953.305, 953.304	04.97 - 10.02	OM 541.922				- Vehicles with single clutch disc
			4300.90.90 ⊕ 4340.60.00 4350.30.00	430 18	MFZ430 430WGTZ	- Engine code: OM 541
						- Vehicles with single clutch disc
			4350.30.00	430 18	430WGTZ	- Equipment Var: SA 504682-22/24
						- Engine code: OM 541
			4000.90.04 4025.10.00 4025.30.00	400 18	MFZ2/400X 400WGTZ	- Vehicles with single clutch disc
						- For PTO
			4000.90.17 4022.10.00 4025.30.00	400 18	MFZ2/400X 400WGTZ	- Engine code: OM 541
						- Vehicles with double disc clutch
			4300.90.50 ⊕ 4318.60.00 4318.30.00	430 18	MFZ430 430WGTZ	- GBox: Powershift
3231 K 952.304	04.97 - 10.02	OM 541.920	4300.90.15 ⊕ 4329.60.00 4318.30.00	430 18	MFZ430 430WGTZ	- Engine code: OM 541
3235 K 952.304, 952.305, 952.307	04.97 - 10.02	OM 541.922				- Vehicles with single clutch disc
3240 950.306, 953.305	04.97 - 10.02	OM 541.923	4300.90.90 ⊕ 4340.60.00 4350.30.00	430 18	MFZ430 430WGTZ	- Engine code: OM 541
3240 K 952.304, 952.305	04.97 - 10.02	OM 541.925				- Vehicles with single clutch disc
3243 950.306, 953.305	04.97 - 10.02	OM 541.944	4350.30.00	430 18	430WGTZ	- Equipment Var: SA 504682-22/24
3243 K 952.304, 952.305	04.97 - 10.02	OM 541.946				- Engine code: OM 541
			4000.90.04 4025.10.00 4025.30.00	400 18	MFZ2/400X 400WGTZ	- For PTO
						- Vehicles with single clutch disc
			4000.90.17 4022.10.00 4025.30.00	400 18	MFZ2/400X 400WGTZ	- Engine code: OM 541
						- Vehicles with double disc clutch
						- GBox: Powershift
3231 K, 3232 K 932.304, 932.307, 932.305	04.03 -	OM 541.920	4300.90.15 ⊕ 4329.60.00 4318.30.00	430 18	MFZ430 430WGTZ	- Engine code: OM 541
3331 AK, 3332 AK 932.182, 932.183	04.03 -	OM 541.940				- Vehicles with single clutch disc
3331 S, 3332 S 934.161	04.03 -	OM 541.942	4300.90.90 ⊕ 4340.60.00 4350.30.00	430 18	MFZ430 430WGTZ	- Engine code: OM 541
3332 K 932.162, 932.163, 932.161	04.03 -	OM 541.970				- Vehicles with single clutch disc
3336 K 932.304, 932.307, 932.305	04.03 -	OM 541.972	4350.30.00	430 18	430WGTZ	- Equipment Var: SA 504682-22/24
3336 S 934.161	04.03 -					- Engine code: OM 541
			4000.90.04 4025.10.00 4025.30.00	400 18	MFZ2/400X 400WGTZ	- For PTO
						- Vehicles with single clutch disc
			4000.90.17 4022.10.00 4025.30.00	400 18	MFZ2/400X 400WGTZ	- Engine code: OM 541
						- Vehicles with double disc clutch
						- GBox: Powershift

Vehicle list

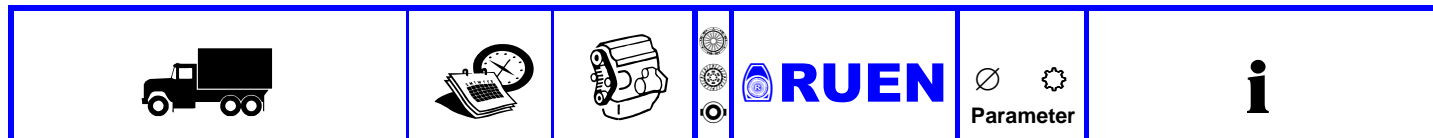

MERCEDES-BENZ

ACTROS 3231 - 3336

04.96 -

3240 B 953.305, 953.304 3243 B 953.305, 953.304	04.97 - 10.02	OM 541.923		4300.90.15 ⊕ 4329.60.00 4318.30.00	430 18 MFZ430 430WGTZ	- Engine code: OM 541 - Vehicles with single clutch disc	
	04.97 - 10.02	OM 541.925		4300.90.90 ⊕ 4340.60.00 4350.30.00	430 18 MFZ430 430WGTZ	- Engine code: OM 541 - Vehicles with single clutch disc - Equipment Var: SA 504682-22/24	
					4350.30.00	430 18 430WGTZ	- Engine code: OM 541 - For PTO - Vehicles with single clutch disc
					4000.90.04 4025.10.00 4025.30.00	400 18 MFZ2/400X 400WGTZ	- Engine code: OM 541 - Vehicles with double disc clutch
					4000.90.17 4022.10.00 4025.30.00	400 18 MFZ2/400X 400WGTZ	- Engine code: OM 541 - Vehicles with double disc clutch - GBox: Powershift
3331 950.162, 950.163 3331 A 950.182, 950.183 3331 B 953.161, 953.163, 953.162 3331 S 954.161	04.97 - 10.02	OM 541.920		4300.90.15 ⊕ 4329.60.00 4318.30.00	430 18 MFZ430 430WGTZ	- Engine code: OM 541 - Vehicles with single clutch disc	
	04.97 - 10.02	OM 541.926		4300.90.90 ⊕ 4340.60.00 4350.30.00	430 18 MFZ430 430WGTZ	- Engine code: OM 541 - Vehicles with single clutch disc - Equipment Var: SA 504682-22/24	
	04.97 - 10.02			4350.30.00	430 18 430WGTZ	- Engine code: OM 541 - For PTO - Vehicles with single clutch disc	
	04.97 - 10.02			4000.90.04 4025.10.00 4025.30.00	400 18 MFZ2/400X 400WGTZ	- Engine code: OM 541 - Vehicles with double disc clutch	
				4000.90.17 4022.10.00 4025.30.00	400 18 MFZ2/400X 400WGTZ	- Engine code: OM 541 - Vehicles with double disc clutch - GBox: OM 541	
				4300.90.50 ⊕ 4318.60.00 4318.30.00	430 18 MFZ430 430WGTZ		
3331 AK 952.183, 952.182 3331 AS 954.182 3331 K 952.163, 952.161, 952.162 3335 950.162 3335 K 952.163, 952.161, 952.162 3335 S 954.161	04.97 - 10.02	OM 541.920		4300.90.15 ⊕ 4329.60.00 4318.30.00	430 18 MFZ430 430WGTZ	- Engine code: OM 541 - Vehicles with single clutch disc	
	04.97 - 10.02	OM 541.922		4300.90.90 ⊕ 4340.60.00 4350.30.00	430 18 MFZ430 430WGTZ	- Engine code: OM 541 - Vehicles with single clutch disc - Equipment Var: SA 504682-22/24	
	04.97 - 10.02	OM 541.926		4350.30.00	430 18 430WGTZ	- Engine code: OM 541 - For PTO - Vehicles with single clutch disc	
	04.97 - 10.02			4000.90.04 4025.10.00 4025.30.00	400 18 MFZ2/400X 400WGTZ	- Engine code: OM 541 - Vehicles with double disc clutch	
	04.97 - 10.02			4000.90.17 4022.10.00 4025.30.00	400 18 MFZ2/400X 400WGTZ	- Engine code: OM 541 - Vehicles with double disc clutch - GBox: Powershift	

Vehicle list



MERCEDES-BENZ

ACTROS 3231 - 3336 04.96 -

3335 B 953.161, 953.163, 953.162	04.97 - 10.02	OM 541.922	4300.90.15 ⊕ 4329.60.00 4318.30.00	430 18 MFZ430 430WGTZ	- Engine code: OM 541 - Vehicles with single clutch disc
			4300.90.90 ⊕ 4340.60.00 4350.30.00	430 18 MFZ430 430WGTZ	- Engine code: OM 541 - Vehicles with single clutch disc - Equipment Var: SA 504682-22/24
			4350.30.00	430 18 430WGTZ	- Engine code: OM 541 - For PTO - Vehicles with single clutch disc
			4000.90.04 4025.10.00 4025.30.00	400 18 MFZ2/400X 400WGTZ	- Engine code: OM 541 - Vehicles with double disc clutch
			4000.90.17 4022.10.00 4025.30.00	400 18 MFZ2/400X 400WGTZ	- Engine code: OM 541 - Vehicles with double disc clutch - GBox: Powershift
			4300.90.50 ⊕ 4318.60.00 4318.30.00	430 18 MFZ430 430WGTZ	

Vehicle list

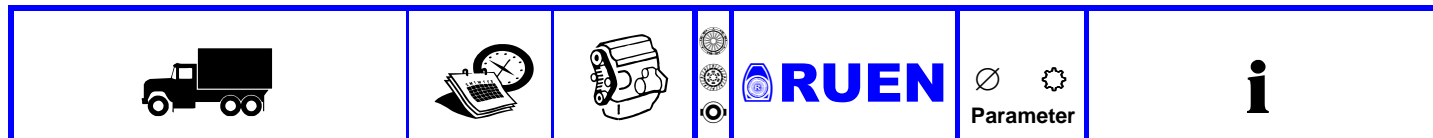

MERCEDES-BENZ

ACTROS 3231 - 3336

04.96 -

3231 932.304, 932.307, 932.305	04.97 -	OM 501 LA	4300.90.15 ⊕	430 18	- Engine code: OM 541 - Vehicles with single clutch disc
3331 B 933.163, 933.162, 933.161	04.03 -	OM 541.920	4329.60.00	MFZ430	
3231 B 933.304, 933.305	04.03 -	OM 541.922	4318.30.00	430WGTZ	
3331 K 932.162, 932.163, 932.161	04.03 -	OM 541.923	4300.90.90 ⊕	430 18	- Engine code: OM 541 - Vehicles with single clutch disc
3232 B 933.307, 933.304, 933.305	04.03 -	OM 541.924	4340.60.00	MFZ430	- Equipment Var: SA 504682-22/24
3235 953.305	04.97 - 10.02	OM 541.925	4350.30.00	430WGTZ	
3235 B 933.304, 933.305	04.03 -	OM 541.926	4350.30.00	430 18	- Engine code: OM 541 - For PTO
3335 B 933.163, 933.162, 933.161	04.03 -	OM 541.927		430WGTZ	- Vehicles with single clutch disc
3335 K 932.162, 932.163, 932.161	04.03 -	OM 541.940	4000.90.04	400 18	- Engine code: OM 541 - Vehicles with double disc clutch
3235 K 932.304, 932.307, 932.305	04.03 -	OM 541.941	4025.10.00	MFZ2/400X	
3236 B 933.307, 933.304, 933.305	04.03 -	OM 541.942	4025.30.00	400WGTZ	
3236 K 932.304, 932.307, 932.305	04.03 -	OM 541.943	4000.90.17	400 18	- Engine code: OM 541 - Vehicles with double disc clutch
3236 L	04.03 -	OM 541.944	4022.10.00	MFZ2/400X	- GBox: Powershift
3339 A 930.182, 930.183	04.03 -	OM 541.945	4025.30.00	400WGTZ	
3339 AK 932.182, 932.183	04.03 -	OM 541.946			
3339 B 933.163, 933.162, 933.161	04.03 -	OM 541.948			
3339 K 932.162, 932.163, 932.161	04.03 -	OM 541.949			
3240 930.306	04.03 -	OM 541.970			
3240 B 933.304, 933.305	04.03 -	OM 541.971			
3240 K 932.304, 932.307, 932.305	04.03 -	OM 541.972			
3241 930.306	04.03 -	OM 541.973			
3241 B 933.307, 933.304, 933.305	04.03 -	OM 541.974			
3241 K 932.304, 932.307, 932.305	04.03 -	OM 541.976			
3241 L 930.306	04.03 -	OM 541.977			
3243 930.306	04.03 -	OM 541.978			
3243 B 933.304, 933.305	04.03 -	OM 541.980			
3243 K 932.304, 932.307, 932.305	04.03 -	OM 541.981			
3244 930.306	04.03 -	OM 541.982			
3244 B 933.307, 933.304, 933.305	04.03 -	OM 541.983			
3244 K 932.304, 932.307, 932.305	04.03 -	OM 541.984			
3246 930.306	04.03 -	OM 541.985			
3246 B 953.305, 953.304	10.97 -	OM 541.986			
3246 B 933.307, 933.304, 933.305	04.03 -	OM 541.987			
3246 K 952.304, 952.305	10.97 -	OM 541.988			
3246 K 932.304, 932.307, 932.305	04.03 -	OM 541.989			
3248, L 930.306	04.03 -	OM 541.990			
3248 B 933.307, 933.304, 933.305	04.03 -	OM 541.991			
3248 K 932.304, 932.307, 932.305	04.03 -	OM 541.992			
3331 932.182, 932.183, 932.162, 930.163, 930.162, 930.182, 932.163, 930.183, 932.161	04.97 -	OM 541.993			
3331, 3332 930.163, 930.162	04.03 -	OM 541.994			
3331 A, 3332 A 930.182, 930.183	04.03 -	OM 541.995			
3332 AK 932.182, 932.183	04.03 -	OM 541.996			
3332 AS 934.182	04.03 -	OM 541.997			
3332 B 933.163, 933.162, 933.161	04.03 -	OM 541.998			
3332 B 933.306, 933.307, 933.304, 933.305	01.03 -				
3335 AK 952.183, 952.182	10.97 - 10.03				

Vehicle list



MERCEDES-BENZ

ACTROS 3231 - 3336 04.96 -

3336 930.163, 930.162 3336 A 930.182, 930.183 3336 AK 932.182, 932.183 3336 AS 934.182 3336 B 933.163, 933.162, 933.161 3336 B 933.306, 933.307, 933.304, 933.305 3336 K 932.162, 932.163, 932.161 3336 S 954.161	04.03 -	OM 501 LA	4300.90.15 ⊕	430 18	- Engine code: OM 541 - Vehicles with single clutch disc
	04.03 -	OM 541.927	4329.60.00	MFZ430	
	04.03 -	OM 541.942	4318.30.00	430WGTZ	
	04.03 -	OM 541.943	4300.90.90 ⊕	430 18	- Engine code: OM 541
	04.03 -	OM 541.972	4340.60.00	MFZ430	- Vehicles with single clutch disc
	01.03 -	OM 541.973	4350.30.00	430WGTZ	- Equipment Var: SA 504682-22/24
3250 930.163, 930.162 3255 L 930.162	04.03 -	OM 542.940	4300.90.381 ⊕	430 18	- Engine code: OM 542
	02.09 -	OM 542.962	4329.60.00	MFZ430	- Vehicles with single clutch disc
			4351.30.00	430WGTZ	
			4000.90.04	400 18	- Engine code: OM 542
			4025.10.00	MFZ2/400X	- Vehicles with double disc clutch
			4025.30.00	400WGTZ	
3260 L 930.162	02.09 -	OM 542.964	4300.90.382 ⊕	430 18	- Engine code: OM 542
			4349.60.00	MFZ430	- Vehicles with single clutch disc
			4352.30.00	430WGTZ	
			4000.90.04	400 18	- Engine code: OM 542
			4025.10.00	MFZ2/400X	- Vehicles with double disc clutch
			4025.30.00	400WGTZ	
3340 950.163 3340 A 950.182, 950.183 3340 B 953.161, 953.163, 953.162	04.97 - 10.02	OM 541.923	4300.90.15 ⊕	430 18	- Engine code: OM 541
	04.97 - 10.02	OM 541.924	4329.60.00	MFZ430	- Vehicles with single clutch disc
	04.97 - 10.02		4318.30.00	430WGTZ	
			4300.90.90 ⊕	430 18	- Engine code: OM 541
			4340.60.00	MFZ430	- Vehicles with single clutch disc
			4350.30.00	430WGTZ	- Equipment Var: SA 504682-22/24
			4350.30.00	430 18	- Engine code: OM 541
				430WGTZ	- For PTO
					- Vehicles with single clutch disc
			4000.90.04	400 18	- Engine code: OM 541
			4025.10.00	MFZ2/400X	- Vehicles with double disc clutch
			4025.30.00	400WGTZ	
			4000.90.17	400 18	- Engine code: OM 541
			4022.10.00	MFZ2/400X	- Vehicles with double disc clutch
			4025.30.00	400WGTZ	- GBox: Powershift

ACTROS 3340 - 3550 06.96 -

3340 950.163 3340 A 950.182, 950.183 3340 B 953.161, 953.163, 953.162	04.97 - 10.02	OM 541.923	4300.90.15 ⊕	430 18	- Engine code: OM 541
	04.97 - 10.02	OM 541.924	4329.60.00	MFZ430	- Vehicles with single clutch disc
	04.97 - 10.02		4318.30.00	430WGTZ	
			4300.90.90 ⊕	430 18	- Engine code: OM 541
			4340.60.00	MFZ430	- Vehicles with single clutch disc
			4350.30.00	430WGTZ	- Equipment Var: SA 504682-22/24
			4350.30.00	430 18	- Engine code: OM 541
				430WGTZ	- For PTO
					- Vehicles with single clutch disc
			4000.90.04	400 18	- Engine code: OM 541
			4025.10.00	MFZ2/400X	- Vehicles with double disc clutch
			4025.30.00	400WGTZ	
			4000.90.17	400 18	- Engine code: OM 541
			4022.10.00	MFZ2/400X	- Vehicles with double disc clutch
			4025.30.00	400WGTZ	- GBox: Powershift

Vehicle list



MERCEDES-BENZ

ACTROS 3340 - 3550 06.96 -

3340 AK 952.183, 952.182	04.97 - 10.02	OM 541.921	4300.90.15 ⊕	430 18	- Engine code: OM 541
3340 AS 954.182	04.97 - 10.02	OM 541.923	4329.60.00	MFZ430	- Vehicles with single clutch disc
3340 K 952.163, 952.161, 952.162	04.97 - 10.02	OM 541.924	4318.30.00	430WGTZ	
3343 AK 952.183, 952.182	04.97 - 10.02	OM 541.925	4300.90.90 ⊕	430 18	- Engine code: OM 541
3343 AS 954.182	04.97 - 10.02		4340.60.00	MFZ430	- Vehicles with single clutch disc
3343 K 952.163, 952.161	04.97 - 10.02		4350.30.00	430WGTZ	- Equipment Var: SA 504682-22/24
			4350.30.00	430 18	- Engine code: OM 541
				430WGTZ	- For PTO
					- Vehicles with single clutch disc
			4000.90.04	400 18	- Engine code: OM 541
			4025.10.00	MFZ2/400X	- Vehicles with double disc clutch
			4025.30.00	400WGTZ	
			4000.90.17	400 18	- Engine code: OM 541
			4022.10.00	MFZ2/400X	- Vehicles with double disc clutch
			4025.30.00	400WGTZ	- GBox: Powershift
3340 S 954.161	04.97 - 10.02	OM 541.923	4300.90.15 ⊕	430 18	- Engine code: OM 541
3343 950.162, 950.163	04.97 - 10.02	OM 541.925	4329.60.00	MFZ430	- Vehicles with single clutch disc
3343 S 954.161	04.97 - 10.02		4318.30.00	430WGTZ	
			4300.90.90 ⊕	430 18	- Engine code: OM 541
			4340.60.00	MFZ430	- Vehicles with single clutch disc
			4350.30.00	430WGTZ	- Equipment Var: SA 504682-22/24
			4350.30.00	430 18	- Engine code: OM 541
				430WGTZ	- For PTO
					- Vehicles with single clutch disc
			4000.90.04	400 18	- Engine code: OM 541
			4025.10.00	MFZ2/400X	- Vehicles with double disc clutch
			4025.30.00	400WGTZ	
			4000.90.17	400 18	- Engine code: OM 541
			4022.10.00	MFZ2/400X	- Vehicles with double disc clutch
			4025.30.00	400WGTZ	- GBox: Powershift
3341 S 934.161	04.03 -	OM 541.923	4300.90.15 ⊕	430 18	- Engine code: OM 541
3344 S 934.161	04.03 -	OM 541.944	4329.60.00	MFZ430	- Vehicles with single clutch disc
3346 S 934.161	04.03 -	OM 541.946	4318.30.00	430WGTZ	
		OM 541.948	4300.90.90 ⊕	430 18	- Engine code: OM 541
		OM 541.974	4340.60.00	MFZ430	- Vehicles with single clutch disc
		OM 541.976	4350.30.00	430WGTZ	- Equipment Var: SA 504682-22/24
			4350.30.00	430 18	- Engine code: OM 541
				430WGTZ	- For PTO
					- Vehicles with single clutch disc
			4000.90.04	400 18	- Engine code: OM 541
			4025.10.00	MFZ2/400X	- Vehicles with double disc clutch
			4025.30.00	400WGTZ	
			4000.90.17	400 18	- Engine code: OM 541
			4022.10.00	MFZ2/400X	- Vehicles with double disc clutch
			4025.30.00	400WGTZ	- GBox: Powershift
3348 950.162, 950.163	04.97 - 10.02	OM 542.920	4300.90.381 ⊕	430 18	- Engine code: OM 542
3353 950.162, 950.163	04.97 - 10.02	OM 542.921	4329.60.00	MFZ430	- Vehicles with single clutch disc
			4351.30.00	430WGTZ	
			4000.90.04	400 18	- Engine code: OM 542
			4025.10.00	MFZ2/400X	- Vehicles with double disc clutch
			4025.30.00	400WGTZ	
			4000.90.17	400 18	- Engine code: OM 542
			4022.10.00	MFZ2/400X	- Vehicles with double disc clutch
			4025.30.00	400WGTZ	- GBox: Powershift

Vehicle list



MERCEDES-BENZ

ACTROS 3340 - 3550 06.96 -

3348 AK 952.182 3348 AS 954.182 3348 K 952.163, 952.161 3353 AS 954.182	04.97 - 10.02 04.97 - 10.02 04.97 - 10.02 04.97 - 10.02	OM 542.920 OM 542.921 OM 542.925	4300.90.381 ⊕ 4329.60.00 4351.30.00	430 18 MFZ430 430WGTZ	- Engine code: OM 542 - Vehicles with single clutch disc
			4000.90.04 4025.10.00 4025.30.00	400 18 MFZ2/400X 400WGTZ	- Engine code: OM 542 - Vehicles with double disc clutch
			4000.90.17 4022.10.00 4025.30.00	400 18 MFZ2/400X 400WGTZ	- Engine code: OM 542 - Vehicles with double disc clutch - GBox: Powershift
3348 S 954.161 3353 S 954.161 3357 S 954.161	04.97 - 10.02 04.97 - 10.02 04.97 - 10.02	OM 542.920 OM 542.921 OM 542.922	4300.90.381 ⊕ 4329.60.00 4351.30.00	430 18 MFZ430 430WGTZ	- Engine code: OM 542 - Vehicles with single clutch disc
			4000.90.04 4025.10.00 4025.30.00	400 18 MFZ2/400X 400WGTZ	- Engine code: OM 542 - Vehicles with double disc clutch
			4000.90.17 4022.10.00 4025.30.00	400 18 MFZ2/400X 400WGTZ	- Engine code: OM 542 - Vehicles with double disc clutch - GBox: Powershift
3348 S 934.161 3351 S 934.161	04.03 - 04.03 -	OM 542.921 OM 542.940 OM 542.960	4300.90.381 ⊕ 4329.60.00 4351.30.00	430 18 MFZ430 430WGTZ	- Engine code: OM 542 - Vehicles with single clutch disc
			4000.90.04 4025.10.00 4025.30.00	400 18 MFZ2/400X 400WGTZ	- Engine code: OM 542 - Vehicles with double disc clutch
			4000.90.17 4022.10.00 4025.30.00	400 18 MFZ2/400X 400WGTZ	- Engine code: OM 542 - Vehicles with double disc clutch - GBox: Powershift
3357 950.162	04.97 - 10.02	OM 542.922	4300.90.382 ⊕ 4349.60.00 4352.30.00	430 18 MFZ430 430WGTZ	- Engine code: OM 542 - Vehicles with single clutch disc
			4000.90.04 4025.10.00 4025.30.00	400 18 MFZ2/400X 400WGTZ	- Engine code: OM 542 - Vehicles with double disc clutch
			4000.90.17 4022.10.00 4025.30.00	400 18 MFZ2/400X 400WGTZ	- Engine code: OM 542 - Vehicles with double disc clutch - GBox: Powershift

Vehicle list



MERCEDES-BENZ

ACTROS 3340 - 3550 06.96 -

Vehicle Model	Year Range	Engine Code	Clutch Part	Price	Clutch Type	Notes
3340 B 953.305	04.97 - 10.02	OM 501 LA	4300.90.15	4300.90.15	430 18	- Engine code: OM 541
3341 930.163, 930.162	04.03 -	OM 541.921	4329.60.00	4329.60.00	MFZ430	- Vehicles with single clutch disc
3341 A 930.182, 930.183	04.03 -	OM 541.923	4318.30.00	4318.30.00	430WGTZ	
3341 AK 932.182, 932.183	04.03 -	OM 541.925	4300.90.90	4300.90.90	430 18	- Engine code: OM 541
3341 AS 934.182	04.03 -	OM 541.944	4340.60.00	4340.60.00	MFZ430	- Vehicles with single clutch disc
3341 B 933.163, 933.162, 933.161	04.03 -	OM 541.945	4350.30.00	4350.30.00	430WGTZ	- Equipment Var: SA 504682-22/24
3341 B 933.306, 933.307, 933.304, 933.305	01.03 -	OM 541.946	4350.30.00	4350.30.00	430 18	- Engine code: OM 541
3341 K 932.162, 932.163, 932.161	04.03 -	OM 541.948			430WGTZ	- For PTO
3341 S 954.161	10.97 -	OM 541.949	4000.90.04	4000.90.04	400 18	- Engine code: OM 541
3343 AK 932.182, 932.183	04.03 -	OM 541.974	4025.10.00	4025.10.00	MFZ2/400X	- Vehicles with double disc clutch
3343 B 953.305	04.97 - 10.02	OM 541.975	4025.30.00	4025.30.00	400WGTZ	
3343 B 933.163, 933.162, 933.161	04.03 -	OM 541.976	4000.90.17	4000.90.17	400 18	- Engine code: OM 541
3343 K 932.162, 932.163, 932.161	04.03 -	OM 541.977	4022.10.00	4022.10.00	MFZ2/400X	- Vehicles with double disc clutch
3344 930.163, 930.162	04.03 -	OM 541.978	4025.30.00	4025.30.00	400WGTZ	- GBox: Powershift
3344 A 930.182, 930.183	04.03 -	OM 541.980				
3344 AK 932.182, 932.183	04.03 -	OM 541.981				
3344 AS 934.182, 934.183	04.03 -	OM 541.990				
3344 B 933.163, 933.162, 933.161	04.03 -	OM 541.991				
3344 B 933.306, 933.307, 933.304, 933.305	01.03 -	OM 541.992				
3344 K 932.162, 932.163, 932.161	04.03 -	OM 541.993				
3346	04.97 - 10.02	OM 541.994				
3346 930.163, 930.162	04.03 -	OM 541.995				
3346 A 930.182, 930.183	04.03 -					
3346 AK 952.183, 952.182	10.97 -					
3346 AK 932.182, 932.183	04.03 -					
3346 AS 954.182	10.97 -					
3346 AS 934.182	04.03 -					
3346 B 933.163, 933.162, 933.161	04.03 -					
3346 B 933.306, 933.307, 933.304, 933.305	01.03 -					
3346 K 952.163, 952.161	10.97 -					
3346 K 932.162, 932.163, 932.161	04.03 -					
3346 S 954.161	10.97 -					
3348 930.163, 930.162	04.03 -					
3348 AK 932.182, 932.183	04.03 -					
3348 AS 934.182	04.03 -					
3348 B 933.163, 933.162, 933.161	04.03 -					
3348 K 932.162, 932.163, 932.161	04.03 -					
3348 S 934.161	04.03 -					

Vehicle list

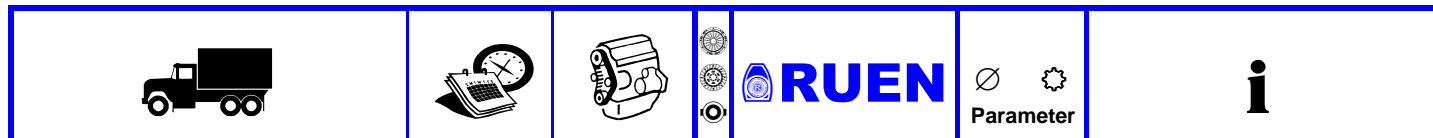

MERCEDES-BENZ

ACTROS 3340 - 3550

06.96 -

3348 930.163, 930.162	04.03 -	OM 541.941	4300.90.381 ⊕	430 18	- Engine code: OM 542
3348 AS 934.182	04.03 -	OM 542.921	4329.60.00	MFZ430	- Vehicles with single clutch disc
3348 AK 932.182, 932.183	04.03 -	OM 542.925	4351.30.00	430WGTZ	
3348 K 932.163, 932.161	04.03 -	OM 542.940	4000.90.04	400 18	- Engine code: OM 542
3350, 3351 930.163, 930.162	04.03 -	OM 542.941	4025.10.00	MFZ2/400X	- Vehicles with double disc clutch
3350 AK 952.182	10.97 -	OM 542.942	4025.30.00	400WGTZ	
3350 AS 954.182	10.97 -	OM 542.960	4000.90.17	400 18	- Engine code: OM 542
3350 K 952.163, 952.161	10.97 -	OM 542.961	4022.10.00	MFZ2/400X	- Vehicles with double disc clutch
3350 S 954.161	10.97 -	OM 542.962	4025.30.00	400WGTZ	- GBox: Powershift
3350 S 934.251	06.09 -	OM 542.963			
3550 S 934.161	06.09 -				
3351 A 930.182, 930.183	06.08 -				
3351 AK 932.182, 932.183	04.03 -				
3351 AS 934.182	04.03 -				
3351 K 932.163, 932.161	04.03 -				
3354, 3355 930.163, 930.162	04.03 -				
3355 A 930.182, 930.183	04.03 -				
3355 AS 934.182	04.03 -				
3355 S 934.161	04.03 -				
3355 AK 932.183	04.03 -				
3358 930.162	04.03 -	OM	4300.90.382 ⊕	430 18	- Engine code: OM 542
3358 K	04.03 -	542.965	4349.60.00	MFZ430	- Vehicles with single clutch disc
3360 930.162	04.03 -	OM 542.944	4352.30.00	430WGTZ	
3360 A 930.182, 930.183	04.03 -		4000.90.04	400 18	- Engine code: OM 542
3360 AK 932.183	04.03 -		4025.10.00	MFZ2/400X	- Vehicles with double disc clutch
			4025.30.00	400WGTZ	
			4000.90.17	400 18	- Engine code: OM 542
			4022.10.00	MFZ2/400X	- Vehicles with double disc clutch
			4025.30.00	400WGTZ	- GBox: Powershift
3365 A	04.03 -	OM 542.968	4000.90.04	400 18	- Engine code: OM 542
		OM 542.969	4025.10.00	MFZ2/400X	- Vehicles with double disc clutch
			4025.30.00	400WGTZ	
			4000.90.17	400 18	- Engine code: OM 542
			4022.10.00	MFZ2/400X	- Vehicles with double disc clutch
			4025.30.00	400WGTZ	- GBox: Powershift

ACTROS 4140 - 4165

06.96 -

4140 AK 952.336, 290kW	04.97 - 10.02	OM 541.921	4300.90.15 ⊕	430 18	- Engine code: OM 541
4140 K 952.325, 290kW, 8X6/4	04.97 - 10.02	OM 541.924	4329.60.00	MFZ430	- Vehicles with single clutch disc
4143 AK 952.336	04.97 - 10.02	OM 542.925	4318.30.00	430WGTZ	
4143 K 952.325, 8X6/4	04.97 - 10.02		4300.90.90 ⊕	430 18	- Engine code: OM 541
4148 AK 952.336	04.97 - 10.02		4340.60.00	MFZ430	- Vehicles with single clutch disc
4148 K 952.325, 8X6/4	04.97 - 10.02		4350.30.00	430WGTZ	- Equipment Var: SA 504682-22/24
			4350.30.00	430 18	- Engine code: OM 541
				430WGTZ	- For PTO
					- Vehicles with single clutch disc
			4000.90.04	400 18	- Engine code: OM 541
			4025.10.00	MFZ2/400X	- Vehicles with double disc clutch
			4025.30.00	400WGTZ	
			4000.90.17	400 18	- Engine code: OM 541
			4022.10.00	MFZ2/400X	- Vehicles with double disc clutch
			4025.30.00	400WGTZ	- GBox: Powershift

Vehicle list

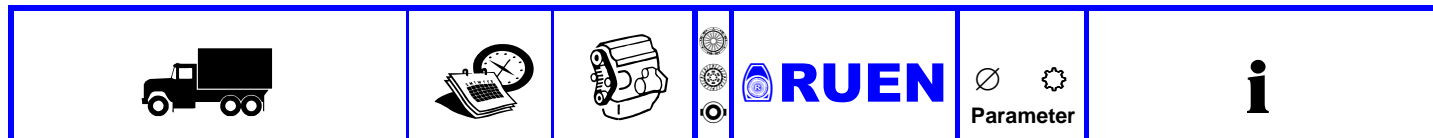

MERCEDES-BENZ

ACTROS 4140 - 4165

06.96 -

4140 AK 932.336, 290-300kW 4140 B 953.317, 953.314 4140 K 932.325, 290-300kW, 8X6/4 4140 K 932.314, 932.315, 932.317, 290-300kW, 8x4/4 4144 K	04.03 -	OM 541.923	4300.90.15 ⊕	430 18	- Engine code: OM 541 - Vehicles with single clutch disc	
	04.97 - 10.02	OM 541.925	4329.60.00 4318.30.00	MFZ430 430WGTZ		
	04.03 -	OM 541.944	4300.90.90 ⊕	430 18	- Engine code: OM 541 - Vehicles with single clutch disc	
	04.03 -	OM 541.946	4340.60.00 4350.30.00	MFZ430 430WGTZ	- Equipment Var: OM 541	
	04.03 -	OM 541.976	4350.30.00	430 18 430WGTZ	- Engine code: OM 541 - For PTO - Vehicles with single clutch disc	
				4000.90.04 4025.10.00 4025.30.00	400 18 MFZ2/400X 400WGTZ	- Engine code: OM 541 - Vehicles with double disc clutch
4140 K 952.314, 952.317, 952.315, 290kW, 8x4/4 4143 K 952.314, 952.317, 952.315, 8x4/4	04.97 - 10.02	OM 541.923	4300.90.15 ⊕	430 18	- Engine code: OM 541 - Vehicles with single clutch disc	
	04.97 - 10.02	OM 541.925	4329.60.00 4318.30.00	MFZ430 430WGTZ		
			4300.90.90 ⊕	430 18	- Engine code: OM 541 - Vehicles with single clutch disc	
			4340.60.00 4350.30.00	MFZ430 430WGTZ	- Equipment Var: SA 504682-22/24	
			4350.30.00	430 18 430WGTZ	- Engine code: OM 541 - For PTO - Vehicles with single clutch disc	
				4000.90.04 4025.10.00 4025.30.00	400 18 MFZ2/400X 400WGTZ	- Engine code: OM 541 - Vehicles with double disc clutch
4148 K 952.314, 952.315, 8x4/4	04.97 - 10.02	OM 542.921	4300.90.381 ⊕	430 18	- Engine code: OM 542 - Vehicles with single clutch disc	
			4329.60.00 4351.30.00	MFZ430 430WGTZ		
			4000.90.04 4025.10.00 4025.30.00	400 18 MFZ2/400X 400WGTZ	- Engine code: OM 542 - Vehicles with double disc clutch	
			4000.90.17 4022.10.00 4025.30.00	400 18 MFZ2/400X 400WGTZ	- Engine code: OM 542 - Vehicles with double disc clutch - GBox: Powershift	

Vehicle list

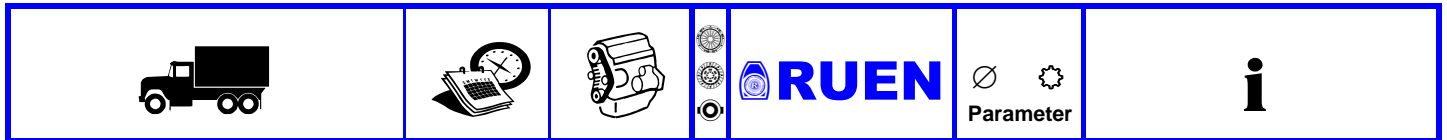

MERCEDES-BENZ

ACTROS 4140 - 4165

06.96 -

4140 932.314, 932.315, 932.336, 932.317, 932.325 4140 B 933.317, 933.314 4140 K 952.336	04.97 -	OM 501 LA		4300.90.15 ⊕	430 18	- Engine code: OM 541 - Vehicles with single clutch disc
	04.03 -	OM 541.921		4329.60.00	MFZ430	
	12.03 -	OM 541.923		4318.30.00	430WGTZ	
4141 930.319 4141 AK	06.08 -	OM 541.924		4300.90.90 ⊕	430 18	- Engine code: OM 541 - Vehicles with single clutch disc
	04.03 -	OM 541.925		4340.60.00	MFZ430	- Equipment Var: SA 504682-22/24
4141 B 933.317, 933.319, 933.314 4141 B	04.03 -	OM 541.944		4350.30.00	430WGTZ	- Engine code: OM 541 - For PTO
	06.08 -	OM 541.946			430 18	- Vehicles with single clutch disc
4141 K 932.314, 932.315, 932.317 4141 K 932.325	04.03 -	OM 541.948		4000.90.04	400 18	- Engine code: OM 541 - Vehicles with double disc clutch
	04.03 -	OM 541.949		4025.10.00	MFZ2/400X	
4141 L 930.319 4143 AK 932.336	01.03 -	OM 541.974		4025.30.00	400WGTZ	
	04.03 -	OM 541.976				
4143 B 933.317, 933.314 4143 K 932.325	04.03 -	OM 541.977		4000.90.17	400 18	- Engine code: OM 541 - Vehicles with double disc clutch
	04.03 -	OM 541.978		4022.10.00	MFZ2/400X	- GBox: Powershift
4144 AK 932.336 4144 B 933.317, 933.319, 933.314	04.03 -	OM 541.980		4025.30.00	400WGTZ	
	04.03 -	OM 541.990				
4144 B 4144 K 932.314, 932.315, 932.317	06.08 -	OM 541.991				
	04.03 -	OM 541.992				
4144 K 932.325 4146 AK 932.336	04.03 -	OM 541.993				
	04.03 -	OM 541.994				
4146 AK 932.336 4146 K 952.336	10.97 -					
	04.03 -					
4146 B 933.317, 933.319, 933.314 4146 B	06.08 -					
	10.97 -					
4146 K 952.314, 952.317, 952.315 4146 K 932.314, 932.315, 932.317	04.03 -					
	04.03 -					
4146 K 932.325 4148 AK 932.336	04.03 -					
	04.03 -					
4148 B 933.317, 933.319, 933.314 4148 B	04.03 -					
	06.08 -					
4148 K 932.314, 932.315, 932.317 4148 AK 932.336	04.03 -					
	04.03 -					
4148 K 932.314, 932.315 4148 K 932.325	04.03 -					
	04.03 -					
4150 AK 932.336 4150 K 932.314, 932.315	04.03 -					
	04.03 -					
4150 K 932.325 4151 AK 932.336	04.03 -					
	04.03 -					
4151 K 932.314, 932.315 4151 K 932.325	05.05 -					
	04.03 -					
4155 AK 932.336 4155 K 932.314, 932.315	04.03 -					
	04.03 -					
4160 AK 932.336 4160 K 932.314, 932.315	04.03 -	OM 542.921		4300.90.381 ⊕	430 18	- Engine code: OM 542 - Vehicles with single clutch disc
	04.03 -	OM 542.925		4329.60.00	MFZ430	
4160 S	10.02 -	OM 542.940		4351.30.00	430WGTZ	
		OM 542.941		4000.90.04	400 18	- Engine code: OM 542 - Vehicles with double disc clutch
		OM 542.960		4025.10.00	MFZ2/400X	
		OM 542.961		4025.30.00	400WGTZ	
		OM 542.962		4000.90.17	400 18	- Engine code: OM 542 - Vehicles with double disc clutch
		OM 542.963		4022.10.00	MFZ2/400X	- GBox: Powershift
				4025.30.00	400WGTZ	
4160 K 932.314, 932.315 4160 S	04.03 -	OM 542.965		4300.90.382 ⊕	430 18	- Engine code: OM 542 - Vehicles with single clutch disc
	04.03 -	OM 542.956		4349.60.00	MFZ430	
	10.02 -	OM 542.957		4352.30.00	430WGTZ	
		OM 542.962		4000.90.04	400 18	- Engine code: OM 542 - Vehicles with double disc clutch
				4025.10.00	MFZ2/400X	
				4025.30.00	400WGTZ	
				4000.90.17	400 18	- Engine code: OM 542 - Vehicles with double disc clutch
				4022.10.00	MFZ2/400X	- GBox: Powershift
				4025.30.00	400WGTZ	

Vehicle list

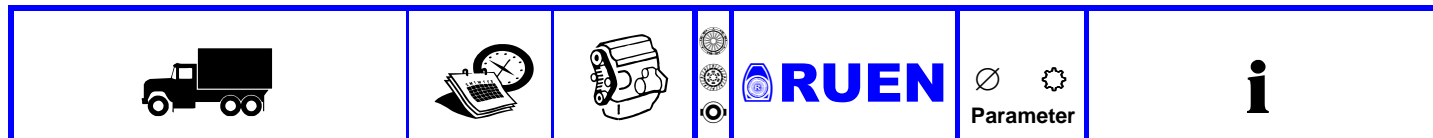

MERCEDES-BENZ

ACTROS 4140 - 4165

06.96 -

4165 AK 932.336 4165 S	04.03 -	OM 542.968		4000.90.04	400 18	- Engine code: OM 542
	08.08 -	OM 542.969		4025.10.00 4025.30.00	MFZ2/400X 400WGTZ	- Vehicles with double disc clutch
				4000.90.17	400 18	- Engine code: OM 542
				4022.10.00 4025.30.00	MFZ2/400X 400WGTZ	- Vehicles with double disc clutch - GBox: Powershift

ATEGO 712 - 717

























712 970.003, 970.005, 970.012, 970.001, 970.013, 970.011, 970.015, 970.017, 970.002 714 K 972.011 714, 714L 715,715 L 970.003, 970.005, 970.203, 970.001, 970.205, 970.017, 970.002 717 K 972.011 717, 717L 970.012, 970.013, 970.011, 970.015, 970.213, 970.017, 970.215, 970.217	01.98 - 10.04	OM 904.909		3620.90.02	362 18	- Engine code: OM904	
			OM 904.910		3606.20.00 3627.30.00	MF362 362WGTTB	
		01.98 - 10.04	OM 904.911		3620.90.32	362 18	- Engine code: OM904
			OM 904.916		3606.20.00 3627.30.00 8603.47.00	MF362 362WGTTB HHIS-3	
		01.98 - 10.04	OM 904.917		3620.90.42	362 18	- Engine code: OM904
			OM 904.922		3606.20.00 3627.30.00 8653.47.00	MF362 362WGTTB HHIS-3	
		01.98 - 10.04			3950.90.01	395 18	- Engine code: OM906
					3952.20.00 3960.30.00	MF395 395GTZ	
					3950.90.34	395 18	- Engine code: OM906
					3952.20.00 3960.30.00 8653.47.00	MF395 395GTZ HHIS-3	
				3950.90.31	395 18	- Engine code: OM906	
				3952.20.00 3960.30.00 8603.47.00	MF395 395GTZ HHIS-3		
				3950.90.35	395 18	- Engine code: OM906	
				3952.20.00 3960.30.00 8601.47.00	MF395 395GTZ		

Vehicle list

					
---	---	---	--	---	---

MERCEDES-BENZ

ATEGO 712 - 717

712, 713 970.003, 970.005, 970.012, 970.001, 970.013, 970.011, 970.015, 970.017, 970.002 715, 715 L, 716, 716 L 970.003, 970.005, 970.203, 970.001, 970.015, 970.205, 970.017, 970.002	10.04 -	OM 900.911		3620.90.02	362 18	- Engine code: OM904
	10.04 -	OM 900.912		3606.20.00	MF362	
		OM 900.917		3627.30.00	362WG TB	
		OM 900.918		3620.90.32	362 18	- Engine code: OM904
		OM 904.909		3606.20.00	MF362	
		OM 904.915		3627.30.00	362WG TB	
		OM 904.922		8603.47.00	HHIS-3	
		3620.90.42	362 18	- Engine code: OM904		
	3606.20.00	MF362				
3627.30.00	362WG TB					
8653.47.00	HHIS-3					
	3950.90.01	395 18	- Engine code: OM906			
	3952.20.00	MF395				
	3960.30.00	395GTZ				
	3950.90.34	395 18	- Engine code: OM906			
	3952.20.00	MF395				
	3960.30.00	395GTZ				
	8653.47.00	HHIS-3				
	3950.90.31	395 18	- Engine code: OM906			
	3952.20.00	MF395				
	3960.30.00	395GTZ				
	8603.47.00	HHIS-3				
	3950.90.35	395 18	- Engine code: OM906			
	3952.20.00	MF395				
	3960.30.00	395GTZ				
	8601.47.00					
712-2628				3961.30.00	395 18	- For PTO
					395GTZ	

Vehicle list

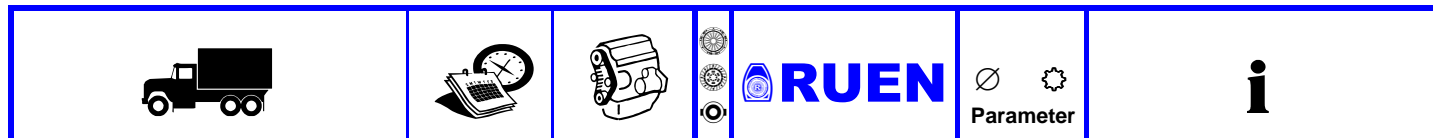

MERCEDES-BENZ

ATEGO 812 - 830

812 970.012, 970.013, 970.011, 970.015, 970.017	01.98 - 10.04	OM 904.909		3620.90.32	362 18	- Engine code: OM904
814 K 972.011, 972.012, 7.49t	01.98 - 10.04	OM 904.910		3606.20.00	MF362	
814 K 972.011, 972.021, 8t	01.98 - 10.04	OM 904.911		3627.30.00	362WG7B	
814, 814 L 970.022, 970.223, 970.027, 970.025, 970.021, 970.023, 970.225, 970.227	01.98 - 10.04	OM 904.916		8603.47.00	HHIS-3	
815 F 976.012, 976.013, 976.011	01.98 - 10.04	OM 904.922		3620.90.42	362 18	- Engine code: OM904
815 K 972.011, 972.012, 972.021, 972.022, 7.49t	01.98 - 10.04			3606.20.00	MF362	
815 K 972.011, 972.012, 972.021, 972.022, 972.032, 8t	01.98 - 10.04			3627.30.00	362WG7B	
815,815 L 970.022, 970.223, 970.027, 970.015, 970.025, 970.021, 970.023, 970.225, 970.227, 8t	01.98 - 10.04			8653.47.00	HHIS-3	
815,815 L 970.012, 970.013, 970.011, 970.015, 970.213, 970.212, 970.017, 970.211, 970.215, 970.217, 7.49t	01.98 - 10.04			3950.90.21	395 18	- Engine code: OM904 - Equipment Var: SA 504672/22
817 K 972.011, 972.012, 972.021, 972.022, 972.032, 8t	01.98 - 10.04			3951.20.00	MF395	
817 K 972.011, 972.012, 7.49t	01.98 - 10.04			3971.30.00	395WG7Z	
817,817 L 970.022, 970.223, 970.027, 970.025, 970.021, 970.023, 970.225, 970.227, 8t	01.98 - 10.04			3950.90.01	395 18	- Engine code: OM906
817,817 L, 7.49t	01.98 - 10.04			3952.20.00	MF395	
				3960.30.00	395GTZ	
				3950.90.03	395 18	- Engine code: OM906
				3951.20.00	MF395	
				3961.30.00	395GTZ	
				3950.90.31	395 18	- Engine code: OM906
				3952.20.00	MF395	
				3960.30.00	395GTZ	
				8603.47.00	HHIS-3	
				3950.90.33	395 18	- Engine code: OM906
				3951.20.00	MF395	
				3961.30.00	395GTZ	
				8603.47.00	HHIS-3	
				3950.90.34	395 18	- Engine code: OM906
				3952.20.00	MF395	
				3960.30.00	395GTZ	
				8653.47.00	HHIS-3	
				3950.90.38	395 18	- Engine code: OM906
				3951.20.00	MF395	
				3961.30.00	395GTZ	
				8653.47.00	HHIS-3	
				3950.90.36	395 18	- Engine code: OM906 - Equipment Var: SA 504673/26
				3952.20.00	MF395	
				3960.30.00	395GTZ	
				8604.47.00		
				3950.90.39	395 18	- Engine code: OM906 - Equipment Var: SA 504673/26
				3951.20.00	MF395	
				3961.30.00	395GTZ	
				8604.47.00		
				3950.90.37	395 18	- Engine code: OM906
				3952.20.00	MF395	
				3960.30.00	395GTZ	
				8602.47.00		
				3950.90.40	395 18	- Engine code: OM906
				3951.20.00	MF395	
				3961.30.00	395GTZ	
				8602.47.00		
				3950.90.35	395 18	- Engine code: OM906
				3952.20.00	MF395	
				3960.30.00	395GTZ	
				8601.47.00		
				3950.90.42	395 18	- Engine code: OM906
				3951.20.00	MF395	
				3961.30.00	395GTZ	
				8601.47.00		

Vehicle list

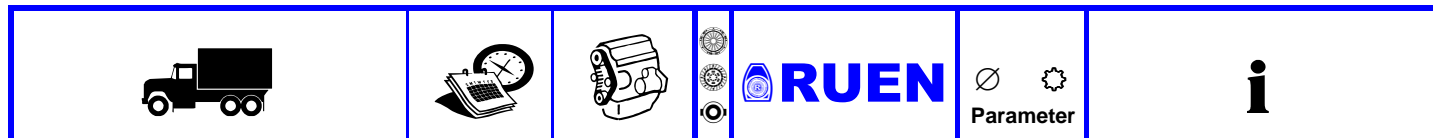

MERCEDES-BENZ

ATEGO 812 - 830

812 K	10.04 -	OM 900.911		3620.90.32	362 18	- Engine code: OM904
812, 813 970.012, 970.013, 970.011, 970.015, 970.017	10.04 -	OM 900.912		3606.20.00	MF362	
815 F 976.012, 976.013, 976.011	10.04 -	OM 900.913		3627.30.00	362WG7B	
815 K, 816 K 972.011, 972.012	10.04 -	OM 900.917		8603.47.00	HHIS-3	
815 K, 816 K 972.011, 972.021, 972.022	10.04 -	OM 900.918		3620.90.42	362 18	- Engine code: OM904
815, 815 L, 816, 816 L	10.04 -	OM 900.919		3606.20.00	MF362	
818 K 972.011, 972.012, 972.021, 972.022	10.04 -	OM 904.909		3627.30.00	362WG7B	
818 K 972.011, 972.012	10.04 -	OM 904.916		8653.47.00	HHIS-3	
818, 818 L	10.04 -	OM 904.922		3950.90.21	395 18	- Engine code: OM904
822 F 976.012, 976.013, 976.011	10.04 -	OM 906.910		3951.20.00	MF395	- Equipment Var: SA 504672/22
822 K 972.011, 972.012	10.04 -	OM 924.920		3971.30.00	395WG7Z	
822 K 972.012, 972.021, 972.022, 972.032	10.04 -	OM 924.922		3950.90.01	395 18	- Engine code: OM906
822, 822 L, 8t	10.04 -	OM 924.930		3952.20.00	MF395	
822, 822 L, 7.49t	10.04 -			3960.30.00	395GTZ	
823 K 972.021, 972.022, 972.032	10.04 -			3950.90.03	395 18	- Engine code: OM906
823, 823 L 970.022, 970.221, 970.223, 970.027, 970.025, 970.021, 970.225, 970.227	10.04 -			3951.20.00	MF395	
	10.04 -			3961.30.00	395GTZ	
	10.04 -			3950.90.31	395 18	- Engine code: OM906
	10.04 -			3952.20.00	MF395	
	10.04 -			3960.30.00	395GTZ	
	10.04 -			8603.47.00	HHIS-3	
	01.98 - 10.04			3950.90.33	395 18	- Engine code: OM906
	01.98 - 10.04			3951.20.00	MF395	
				3961.30.00	395GTZ	
				8603.47.00	HHIS-3	
				3950.90.34	395 18	- Engine code: OM906
				3952.20.00	MF395	
				3960.30.00	395GTZ	
				8653.47.00	HHIS-3	
				3950.90.38	395 18	- Engine code: OM906
				3951.20.00	MF395	
				3961.30.00	395GTZ	
				8653.47.00	HHIS-3	
				3950.90.36	395 18	- Engine code: OM906
				3952.20.00	MF395	- Equipment Var: SA 504673/26
				3960.30.00	395GTZ	
				8604.47.00		
				3950.90.39	395 18	- Engine code: OM906
				3951.20.00	MF395	
				3961.30.00	395GTZ	
				8604.47.00		
				3950.90.37	395 18	- Engine code: OM906
				3952.20.00	MF395	
				3960.30.00	395GTZ	
				8602.47.00		
				3950.90.40	395 18	- Engine code: OM906
				3951.20.00	MF395	
				3961.30.00	395GTZ	
				8602.47.00		
				3950.90.35	395 18	- Engine code: OM906
				3952.20.00	MF395	
				3960.30.00	395GTZ	
				8601.47.00		
				3950.90.42	395 18	- Engine code: OM906
				3951.20.00	MF395	
				3961.30.00	395GTZ	
				8601.47.00		

Vehicle list

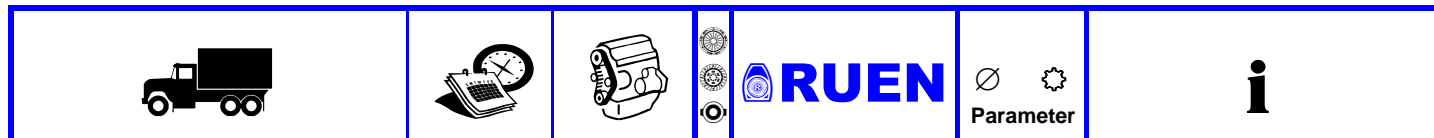

MERCEDES-BENZ

ATEGO 812 - 830

823, 823 L, 824, 824 L 970.022, 970.221, 970.223, 970.027, 970.025, 970.021, 970.222, 970.023, 970.225, 970.227	10.04 -	OM 902.916 OM 906.910 OM 906.915 OM 925.920		3620.90.02 3606.20.00 3627.30.00	362 18 MF362 362WG7B	- Engine code: OM904
824 K 972.011, 972.012, 972.021, 972.022	10.04 -			3620.90.32 3606.20.00 3627.30.00 8603.47.00	362 18 MF362 362WG7B HHIS-3	- Engine code: OM904
824, 824 L 970.022, 970.027, 970.025, 970.021, 970.023	10.04 -			3620.90.42 3606.20.00 3627.30.00 8653.47.00	362 18 MF362 362WG7B HHIS-3	- Engine code: OM904
826, 826 L 970.022, 970.027, 970.025, 970.021, 970.023	10.04 -			3950.90.21 3951.20.00 3971.30.00	395 18 MF395 395WG7Z	- Engine code: OM904 - Equipment Var: SA 504672/22
829, 829 L 970.022, 970.027, 970.025, 970.021, 970.023	10.04 -			3950.90.01 3952.20.00 3960.30.00	395 18 MF395 395GTZ	- Engine code: OM906
				3950.90.03 3951.20.00 3961.30.00	395 18 MF395 395GTZ	- Engine code: OM906
				3950.90.31 3952.20.00 3960.30.00 8603.47.00	395 18 MF395 395GTZ HHIS-3	- Engine code: OM906
				3950.90.33 3951.20.00 3961.30.00 8603.47.00	395 18 MF395 395GTZ HHIS-3	- Engine code: OM906
				3950.90.34 3952.20.00 3960.30.00 8653.47.00	395 18 MF395 395GTZ HHIS-3	- Engine code: OM906
				3950.90.38 3951.20.00 3961.30.00 8653.47.00	395 18 MF395 395GTZ HHIS-3	- Engine code: OM906
				3950.90.37 3952.20.00 3960.30.00 8602.47.00	395 18 MF395 395GTZ	- Engine code: OM906
				3950.90.40 3951.20.00 3961.30.00 8602.47.00	395 18 MF395 395GTZ	- Engine code: OM906
				3950.90.35 3952.20.00 3960.30.00 8601.47.00	395 18 MF395 395GTZ	- Engine code: OM906
				3950.90.42 3951.20.00 3961.30.00 8601.47.00	395 18 MF395 395GTZ	- Engine code: OM906

Vehicle list

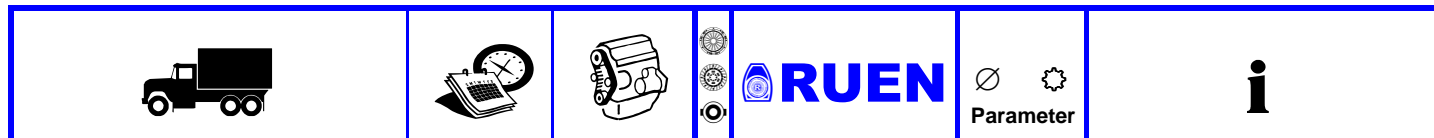







MERCEDES-BENZ

ATEGO 914 - 930



























915 AF 976.332-333		OM 904.911		3620.90.02	362 18	- Engine code: OM904
917 AF 976.334, 976.332, 976.333	01.98 - 10.04	OM 904.917		3606.20.00	MF362	
917 K 972.031, 972.022, 972.032	01.98 - 10.04	OM 906.910		3627.30.00	362WG7B	
917 KO 975.031	01.98 - 10.04	OM 906.919		3620.90.32	362 18	- Engine code: OM904
917,917 L 970.035, 970.031, 970.032, 970.033, 970.235, 970.237, 970.233, 970.037	01.98 - 10.04			3606.20.00	MF362	
923 K 972.031, 972.022	01.98 - 10.04			3627.30.00	362WG7B	
923,923 L 970.035, 970.031, 970.032, 970.033, 970.235, 970.237, 970.233, 970.037	01.98 - 10.04			8603.47.00	HHIS-3	
925 AF 976.334, 976.332, 976.333	01.98 - 10.04			3620.90.42	362 18	- Engine code: OM904
				3606.20.00	MF362	
				3627.30.00	362WG7B	
				8653.47.00	HHIS-3	
				3950.90.21	395 18	- Engine code: OM904 - Equipment Var: SA 504672/22
				3951.20.00	MF395	
				3971.30.00	395WG7Z	
				3950.90.01	395 18	- Engine code: OM906
				3952.20.00	MF395	
				3960.30.00	395GTZ	
				3950.90.03	395 18	- Engine code: OM906
				3951.20.00	MF395	
				3961.30.00	395GTZ	
				3950.90.31	395 18	- Engine code: OM906
				3952.20.00	MF395	
				3960.30.00	395GTZ	
				8603.47.00	HHIS-3	
				3950.90.33	395 18	- Engine code: OM906
				3951.20.00	MF395	
				3961.30.00	395GTZ	
				8603.47.00	HHIS-3	
				3950.90.34	395 18	- Engine code: OM906
				3952.20.00	MF395	
				3960.30.00	395GTZ	
				8653.47.00	HHIS-3	
				3950.90.38	395 18	- Engine code: OM906
				3951.20.00	MF395	
				3961.30.00	395GTZ	
				8653.47.00	HHIS-3	
				3950.90.37	395 18	- Engine code: OM906
				3952.20.00	MF395	
				3960.30.00	395GTZ	
				8602.47.00		
				3950.90.40	395 18	- Engine code: OM906
				3951.20.00	MF395	
				3961.30.00	395GTZ	
				8602.47.00		
				3950.90.35	395 18	- Engine code: OM906
				3952.20.00	MF395	
				3960.30.00	395GTZ	
				8601.47.00		
				3950.90.42	395 18	- Engine code: OM906
				3951.20.00	MF395	
				3961.30.00	395GTZ	
				8601.47.00		

Vehicle list

					
---	---	---	--	---	---

MERCEDES-BENZ

ATEGO 914 - 930

914 K 914, 914 L 970.035, 970.031, 970.032, 970.033, 970.235, 970.237, 970.233, 970.037	01.98 - 10.04	OM 904.916		3620.90.02  3606.20.00  3627.30.00	362 18 MF362 362WG TB	- Engine code: OM904	
	01.98 - 10.04			3620.90.32  3606.20.00  3627.30.00  8603.47.00	362 18 MF362 362WG TB HHIS-3	- Engine code: OM904	
					3620.90.42  3606.20.00  3627.30.00  8653.47.00	362 18 MF362 362WG TB HHIS-3	- Engine code: OM904
					3950.90.01  3952.20.00  3960.30.00	395 18 MF395 395GTZ	- Engine code: OM906
					3950.90.34  3952.20.00  3960.30.00  8653.47.00	395 18 MF395 395GTZ HHIS-3	- Engine code: OM906
					3950.90.31  3952.20.00  3960.30.00  8603.47.00	395 18 MF395 395GTZ HHIS-3	- Engine code: OM906
					3950.90.35  3952.20.00  3960.30.00  8601.47.00	395 18 MF395 395GTZ	- Engine code: OM906

Vehicle list



MERCEDES-BENZ

ATEGO 914 - 930

915 K 972.031, 972.022	10.04 -	OM 900.912	3620.90.02	362 18	- Engine code: OM904
915, 915 L, 916, 916 L 970.035, 970.031, 970.032, 970.033, 970.235, 970.237, 970.233, 970.037	10.04 -	OM 900.913	3606.20.00	MF362	
916 K 972.031, 972.032	10.04 -	OM 900.918	3627.30.00	362WG7B	
916, 916 L 970.035, 970.031, 970.032, 970.033, 970.037	10.04 -	OM 900.919	3620.90.32	362 18	- Engine code: OM904
918 AF 976.334, 976.332, 976.333	10.04 -	OM 902.916	3606.20.00	MF362	
918 K 972.031, 972.032	10.04 -	OM 902.917	3627.30.00	362WG7B	
918, 918 L 970.035, 970.031, 970.032, 970.033, 970.235, 970.237, 970.233, 970.037	10.04 -	OM 904.922	8603.47.00	HHIS-3	
922 AF 976.334, 976.332, 976.333	10.04 -	OM 906.910	3620.90.42	362 18	- Engine code: OM904
922 K 972.031, 972.022, 972.032	10.04 -	OM 906.915	3606.20.00	MF362	
922, 922 L 970.035, 970.031, 970.032, 970.033, 970.235, 970.237, 970.233, 970.037	10.04 -	OM 924.920	3627.30.00	362WG7B	
923, 923 L, 924, 924 L 970.035, 970.031, 970.032, 970.033, 970.235, 970.237, 970.233, 970.037	10.04 -	OM 924.922	8653.47.00	HHIS-3	
924 K 972.031, 972.032	10.04 -	OM 924.930	3950.90.21	395 18	- Engine code: OM904
924, 924 L 970.035, 970.031, 970.032, 970.033, 970.037	10.04 -	OM 924.935	3951.20.00	MF395	- Equipment Var: SA 504672/22
926 AF 976.334, 976.332, 976.333	10.04 -	OM 925.920	3971.30.00	395WG7Z	
926, 926 L 970.035, 970.031, 970.032, 970.033, 970.037	10.04 -		3950.90.01	395 18	- Engine code: OM906
929, 929 L 970.035, 970.031, 970.032, 970.033, 970.037	10.04 -		3952.20.00	MF395	
	10.04 -		3960.30.00	395GTZ	
	10.04 -		3950.90.03	395 18	- Engine code: OM906
	10.04 -		3951.20.00	MF395	
	10.04 -		3961.30.00	395GTZ	
	10.04 -		3950.90.31	395 18	- Engine code: OM906
	10.04 -		3952.20.00	MF395	
	10.04 -		3960.30.00	395GTZ	
	10.04 -		8603.47.00	HHIS-3	
			3950.90.33	395 18	- Engine code: OM906
			3951.20.00	MF395	
			3961.30.00	395GTZ	
			8603.47.00	HHIS-3	
			3950.90.34	395 18	- Engine code: OM906
			3952.20.00	MF395	
			3960.30.00	395GTZ	
			8653.47.00	HHIS-3	
			3950.90.38	395 18	- Engine code: OM906
			3951.20.00	MF395	
			3961.30.00	395GTZ	
			8653.47.00	HHIS-3	
			3950.90.37	395 18	- Engine code: OM906
			3952.20.00	MF395	
			3960.30.00	395GTZ	
			8602.47.00		
			3950.90.40	395 18	- Engine code: OM906
			3951.20.00	MF395	
			3961.30.00	395GTZ	
			8602.47.00		
			3950.90.35	395 18	- Engine code: OM906
			3952.20.00	MF395	
			3960.30.00	395GTZ	
			8601.47.00		
			3950.90.42	395 18	- Engine code: OM906
			3951.20.00	MF395	
			3961.30.00	395GTZ	
			8601.47.00		

Vehicle list

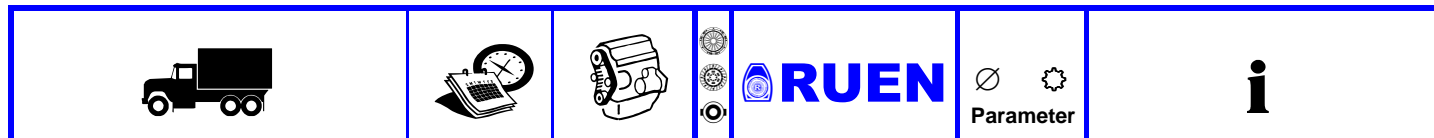

MERCEDES-BENZ

ATEGO 1014 - 1118

1017 A 970.342	01.98 - 10.04	OM 900.913		3620.90.02	362 18	- Engine code: OM904
1017 AK 972.342	01.98 - 10.04	OM 904.911		3606.20.00	MF362	
1017 K 972.042, 972.041	01.98 - 10.04	OM 904.917		3627.30.00	362WG7B	
1017 KO, 1018 KO 975.041	01.98 - 10.04	OM 906.910		3620.90.32	362 18	- Engine code: OM904
1017, 1017 L 970.043, 970.247, 970.042	01.98 - 10.04			3606.20.00	MF362	
970.243, 970.041, 970.047, 970.045, 970.245				3627.30.00	362WG7B	
1023, 1023 L 970.043, 970.247, 970.042	01.98 - 10.04			8603.47.00	HHIS-3	
970.243, 970.041, 970.047, 970.045, 970.245				3620.90.42	362 18	- Engine code: OM904
				3606.20.00	MF362	
				3627.30.00	362WG7B	
				8653.47.00	HHIS-3	
				3950.90.21	395 18	- Engine code: OM904 - Equipment Var: SA 504672/22
				3951.20.00	MF395	
				3971.30.00	395WG7Z	
				3950.90.01	395 18	- Engine code: OM906
				3952.20.00	MF395	
				3960.30.00	395GTZ	
				3950.90.03	395 18	- Engine code: OM906
				3951.20.00	MF395	
				3961.30.00	395GTZ	
				3950.90.31	395 18	- Engine code: OM906
				3952.20.00	MF395	
				3960.30.00	395GTZ	
				8603.47.00	HHIS-3	
				3950.90.33	395 18	- Engine code: OM906
				3951.20.00	MF395	
				3961.30.00	395GTZ	
				8603.47.00	HHIS-3	
				3950.90.34	395 18	- Engine code: OM906
				3952.20.00	MF395	
				3960.30.00	395GTZ	
				8653.47.00	HHIS-3	
				3950.90.38	395 18	- Engine code: OM906
				3951.20.00	MF395	
				3961.30.00	395GTZ	
				8653.47.00	HHIS-3	
				3950.90.37	395 18	- Engine code: OM906
				3952.20.00	MF395	
				3960.30.00	395GTZ	
				8602.47.00		
				3950.90.40	395 18	- Engine code: OM906
				3951.20.00	MF395	
				3961.30.00	395GTZ	
				8602.47.00		
				3950.90.35	395 18	- Engine code: OM906
				3952.20.00	MF395	
				3960.30.00	395GTZ	
				8601.47.00		
				3950.90.42	395 18	- Engine code: OM906
				3951.20.00	MF395	
				3961.30.00	395GTZ	
				8601.47.00		

Vehicle list

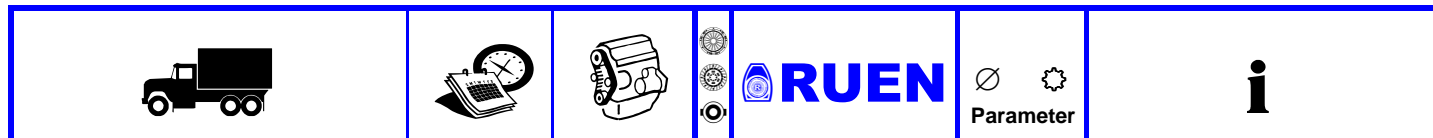

MERCEDES-BENZ

ATEGO 1014 - 1118

1014 K 972.041	01.98 - 10.04	OM 900.912		3620.90.02	362 18	- Engine code: OM904
1014, 1014 L 970.043, 970.247, 970.042, 970.243, 970.041, 970.047, 970.045, 970.245	01.98 - 10.04	OM 900.913		3606.20.00	MF362	
1015 K 972.042	10.04 -	OM 900.918		3627.30.00	362WG7B	
1015 K, 1016 K 972.042, 972.041	10.04 -	OM 900.919		3620.90.32	362 18	- Engine code: OM904
1015, 1015 L 970.043, 970.247, 970.042, 970.243, 970.041, 970.047, 970.045, 970.245	10.04 -	OM 902.916		3606.20.00	MF362	
1016, 1016 L 970.043, 970.042, 970.041, 970.047, 970.045	10.04 -	OM 904.916		3627.30.00	362WG7B	
1016, 1016 L 970.043, 970.247, 970.042, 970.243, 970.041, 970.047, 970.045, 970.245	10.04 -	OM 904.917		8603.47.00	HHIS-3	
1016, 1016 L 970.043, 970.042, 970.041, 970.047, 970.045	10.04 -	OM 904.922		3620.90.42	362 18	- Engine code: OM904
1016, 1016 L 970.043, 970.247, 970.042, 970.243, 970.041, 970.047, 970.045, 970.245	10.04 -	OM 906.910		3606.20.00	MF362	
1017 AK 972.342	10.04 -	OM 906.915		3627.30.00	362WG7B	
1017 K, 1018 K 972.042, 972.041	10.04 -	OM 924.920		8653.47.00	HHIS-3	
1018 A 970.342	10.04 -	OM 924.922		3950.90.21	395 18	- Engine code: OM904
1018 AK 972.342	10.04 -	OM 924.930		3951.20.00	MF395	- Equipment Var: SA 504672/22
1018, 1018 L 970.043, 970.247, 970.042, 970.243, 970.041, 970.047, 970.045, 970.245	10.04 -	OM 924.935		3971.30.00	395WG7Z	
1022 A 970.342	10.04 -	OM 925.920		3950.90.01	395 18	- Engine code: OM906
1022 AK 972.342	10.04 -			3952.20.00	MF395	
1022 K 972.042, 972.041	10.04 -			3960.30.00	395GTZ	
1022 KO 975.041	10.04 -			3950.90.03	395 18	- Engine code: OM906
1022, 1022 L 970.043, 970.247, 970.042, 970.243, 970.041, 970.047, 970.045, 970.245	10.04 -			3951.20.00	MF395	
1023 A, 1024 A 970.342	10.04 -			3961.30.00	395GTZ	
1023 AK 972.342	01.98 - 10.04			3950.90.31	395 18	- Engine code: OM906
1023 K 972.042, 972.041	01.98 - 10.04			3952.20.00	MF395	
1023, 1023 L, 1024, 1024 L 970.043, 970.247, 970.042, 970.243, 970.041, 970.047, 970.045, 970.245	10.04 -			3960.30.00	395GTZ	
1024 AK 972.342	10.04 -			8603.47.00	HHIS-3	
1024 K 972.042, 972.041	10.04 -			3950.90.33	395 18	- Engine code: OM906
1024, 1024 L 970.043, 970.042, 970.041, 970.047, 970.045	10.04 -			3951.20.00	MF395	
1026, 1026 L 970.043, 970.042, 970.041, 970.047, 970.045	10.04 -			3961.30.00	395GTZ	
1029, 1029 L 970.043, 970.042, 970.041, 970.047, 970.045	10.04 -			8653.47.00	HHIS-3	
1118 AF	01.11 -			3950.90.38	395 18	- Engine code: OM906
				3951.20.00	MF395	
				3961.30.00	395GTZ	
				8602.47.00	HHIS-3	
				3950.90.37	395 18	- Engine code: OM906
				3952.20.00	MF395	
				3960.30.00	395GTZ	
				8602.47.00	HHIS-3	
				3950.90.40	395 18	- Engine code: OM906
				3951.20.00	MF395	
				3961.30.00	395GTZ	
				8601.47.00	HHIS-3	
				3950.90.35	395 18	- Engine code: OM906
				3952.20.00	MF395	
				3960.30.00	395GTZ	
				8601.47.00	HHIS-3	
				3950.90.42	395 18	- Engine code: OM906
				3951.20.00	MF395	
				3961.30.00	395GTZ	
				8601.47.00	HHIS-3	

Vehicle list

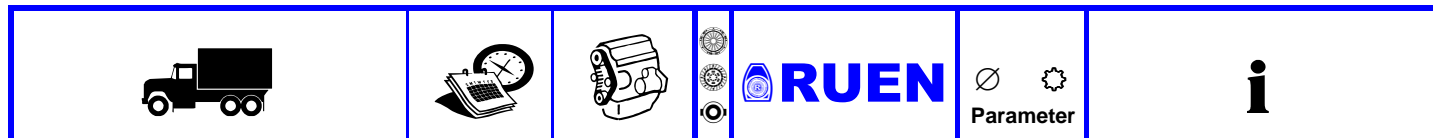

MERCEDES-BENZ

ATEGO 1214 - 1229











1214, 1214 L	01.98 - 10.04	OM 904.910		3620.90.02	362 18	- Engine code: OM904
1215 K 972.052	01.98 - 10.04	OM 904.911		3606.20.00	MF362	
1215,1215 L	01.98 - 10.04	OM 904.916		3627.30.00	362WG7B	
1217 K 972.052, 972.053	01.98 - 10.04	OM 904.922		3620.90.32	362 18	- Engine code: OM904
1217 KO 975.052	01.98 - 10.04	OM 906.910		3606.20.00	MF362	
1217,1217 L	01.98 - 10.04	OM 906.919		3627.30.00	362WG7B	
1223,1223 L	01.98 - 10.04			8603.47.00	HHIS-3	
1225 AF 976.353, 976.354	01.98 - 10.04			3620.90.42	362 18	- Engine code: OM904
1225 F 976.054, 976.053	01.98 - 10.04			3606.20.00	MF362	
				3627.30.00	362WG7B	
				8653.47.00	HHIS-3	
				3950.90.21	395 18	- Engine code: OM904 - Equipment Var: SA 504672/22
				3951.20.00	MF395	
				3971.30.00	395WG7Z	
				3950.90.01	395 18	- Engine code: OM906
				3952.20.00	MF395	
				3960.30.00	395GTZ	
				3950.90.03	395 18	- Engine code: OM906
				3951.20.00	MF395	
				3961.30.00	395GTZ	
				3950.90.31	395 18	- Engine code: OM906
				3952.20.00	MF395	
				3960.30.00	395GTZ	
				8603.47.00	HHIS-3	
				3950.90.33	395 18	- Engine code: OM906
				3951.20.00	MF395	
				3961.30.00	395GTZ	
				8603.47.00	HHIS-3	
				3950.90.34	395 18	- Engine code: OM906
				3952.20.00	MF395	
				3960.30.00	395GTZ	
				8653.47.00	HHIS-3	
				3950.90.38	395 18	- Engine code: OM906
				3951.20.00	MF395	
				3961.30.00	395GTZ	
				8653.47.00	HHIS-3	
				3950.90.37	395 18	- Engine code: OM906
				3952.20.00	MF395	
				3960.30.00	395GTZ	
				8602.47.00		
				3950.90.40	395 18	- Engine code: OM906
				3951.20.00	MF395	
				3961.30.00	395GTZ	
				8602.47.00		
				3950.90.35	395 18	- Engine code: OM906
				3952.20.00	MF395	
				3960.30.00	395GTZ	
				8601.47.00		
				3950.90.42	395 18	- Engine code: OM906
				3951.20.00	MF395	
				3961.30.00	395GTZ	
				8601.47.00		

Vehicle list

			 RUEN	 Parameter	
---	---	---	--	--	---

MERCEDES-BENZ

ATEGO 1214 - 1229

1228, 1228 L 970.050, 970.055, 970.057, 970.255, 970.059, 970.258, 970.253, 970.257, 970.053, 970.058	01.98 - 10.04	OM 906.911	 3950.90.03	395 18	- Engine code: OM906
			 3951.20.00	MF395	
			 3961.30.00	395GTZ	
			 3950.90.33	395 18	- Engine code: OM906
			 3951.20.00	MF395	
			 3961.30.00	395GTZ	
			 8603.47.00	HHIS-3	
			 3950.90.38	395 18	- Engine code: OM906
			 3951.20.00	MF395	
			 3961.30.00	395GTZ	
			 8653.47.00	HHIS-3	

Vehicle list









MERCEDES-BENZ

ATEGO 1214 - 1229











1214 K 972.052	01.98 - 10.04	OM 900.912		3620.90.02	362 18	- Engine code: OM904
1215, 1215 L, 1216, 1216 L	10.04 -	OM 900.913		3606.20.00	MF362	
1216 K 972.052	10.04 -	OM 902.916		3627.30.00	362WG7B	
1216, 1216 L 970.055, 970.083, 970.057, 970.085, 970.087, 970.053, 970.058		OM 902.917		3620.90.32	362 18	- Engine code: OM904
1218 K 972.052, 972.053	10.04 -	OM 904.910		3606.20.00	MF362	
1218, 1218 L	10.04 -	OM 904.916		3627.30.00	362WG7B	
1222 AF 976.353, 976.354	10.04 -	OM 904.922		8603.47.00	HHIS-3	
1222 F 976.054, 976.053	10.04 -	OM 906.910		3620.90.42	362 18	- Engine code: OM904
1222 K 972.052, 972.053	10.04 -	OM 906.915		3606.20.00	MF362	
1222, 1222 L	10.04 -	OM 906LA		3627.30.00	362WG7B	
1223 K 972.052, 972.053	10.04 -	OM 924.920		8653.47.00	HHIS-3	
1223, 1223 L, 1224, 1224 L	10.04 -	OM 924.922		3950.90.21	395 18	- Engine code: OM904
1224 K 972.052, 972.053	01.98 - 09.04	OM 924.930		3951.20.00	MF395	- Equipment Var: SA 504672/22
1224, 1224 L 970.050, 970.055, 970.083, 970.057, 970.085, 970.087, 970.059, 970.053, 970.058	10.04 -	OM 924.935		3971.30.00	395WG7Z	
1225 F 976.054	10.04 -	OM 925.920		3950.90.01	395 18	- Engine code: OM906
1226 AF 976.353, 976.354	10.04 -			3952.20.00	MF395	
1226 F 976.054, 976.053	10.04 -			3960.30.00	395GTZ	
1226, 1226 L 970.050, 970.055, 970.083, 970.057, 970.085, 970.087, 970.059, 970.053, 970.058	10.04 - 12.14			3950.90.03	395 18	- Engine code: OM906
1226, 1226 L 970.050, 970.055, 970.057, 970.255, 970.059, 970.258, 970.253, 970.257, 970.053, 970.058	10.14 -			3951.20.00	MF395	
1229, 1229 L 970.050, 970.055, 970.083, 970.057, 970.085, 970.087, 970.059, 970.053, 970.058	10.04 -			3961.30.00	395GTZ	
				8603.47.00	HHIS-3	
				3950.90.31	395 18	- Engine code: OM906
				3952.20.00	MF395	
				3960.30.00	395GTZ	
				8603.47.00	HHIS-3	
				3950.90.33	395 18	- Engine code: OM906
				3951.20.00	MF395	
				3961.30.00	395GTZ	
				8603.47.00	HHIS-3	
				3950.90.34	395 18	- Engine code: OM906
				3952.20.00	MF395	
				3960.30.00	395GTZ	
				8653.47.00	HHIS-3	
				3950.90.38	395 18	- Engine code: OM906
				3951.20.00	MF395	
				3961.30.00	395GTZ	
				8653.47.00	HHIS-3	
				3950.90.37	395 18	- Engine code: OM906
				3952.20.00	MF395	
				3960.30.00	395GTZ	
				8602.47.00		
				3950.90.40	395 18	- Engine code: OM906
				3951.20.00	MF395	
				3961.30.00	395GTZ	
				8602.47.00		
				3950.90.35	395 18	- Engine code: OM906
				3952.20.00	MF395	
				3960.30.00	395GTZ	
				8601.47.00		
				3950.90.42	395 18	- Engine code: OM906
				3951.20.00	MF395	
				3961.30.00	395GTZ	
				8601.47.00		

Vehicle list







			 RUEN	 Parameter	
---	---	---	--	--	---

MERCEDES-BENZ

ATEGO 1214 - 1229





















































































1228, 1228 L, 1229, 1229 L 970.050, 970.055, 970.057, 970.255, 970.059, 970.258, 970.253, 970.257, 970.053, 970.058	10.04 -	OM 902.918 OM 906.911 OM 906.916	 3950.90.03	395 18	- Engine code: OM906
			 3951.20.00	MF395	
			 3961.30.00	395GTZ	
			 3950.90.33	395 18	- Engine code: OM906
			 3951.20.00	MF395	
			 3961.30.00	395GTZ	
			 8603.47.00	HHIS-3	
			 3950.90.38	395 18	- Engine code: OM906
			 3951.20.00	MF395	
			 3961.30.00	395GTZ	
			 8653.47.00	HHIS-3	

Vehicle list

					
---	---	---	--	---	---

MERCEDES-BENZ

ATEGO 1315 - 1419

1317 A 970.362, 970.363	01.98 - 10.04	OM 900.913		3620.90.02	362 18	- Engine code: OM904
1317 AK 972.362	01.98 - 10.04	OM 904.911		 3606.20.00	MF362	
1317 K 972.062	01.98 - 10.04	OM 906.910		 3627.30.00	362WG7B	
317 KO, 1317 LKO, 1318 KO, 1318 LKO	01.98 - 10.04	OM 906.919		3620.90.32	362 18	- Engine code: OM904
975.062, 975.262				 3606.20.00	MF362	
1317,1317 L 970.063, 970.067, 970.060, 970.068, 970.267, 970.263, 970.268, 970.065, 970.265	01.98 - 10.04			 3627.30.00	362WG7B	
1318 LKO				 8603.47.00	HHIS-3	
1323 KO, 1323 LKO 975.062, 975.262	01.98 - 10.04			3620.90.42	362 18	- Engine code: OM904
1323 LS 974.262, 974.263	01.98 - 10.04			 3606.20.00	MF362	
1323,1323 L 970.063, 970.067, 970.068, 970.267, 970.263, 970.268, 970.065, 970.265	01.98 - 10.04			 3627.30.00	362WG7B	
1325 AF 976.364, 976.363	01.98 - 10.04			 8653.47.00	HHIS-3	
1325 F 976.064, 976.065, 976.063	01.98 - 10.04			3950.90.21	395 18	- Engine code: OM904 - Equipment Var: SA 504672/22
				 3951.20.00	MF395	
				 3971.30.00	395WG7Z	
				3950.90.01	395 18	- Engine code: OM906
				 3952.20.00	MF395	
				 3960.30.00	395GTZ	
				3950.90.03	395 18	- Engine code: OM906
				 3951.20.00	MF395	
				 3961.30.00	395GTZ	
				3950.90.31	395 18	- Engine code: OM906
				 3952.20.00	MF395	
				 3960.30.00	395GTZ	
				 8603.47.00	HHIS-3	
				3950.90.33	395 18	- Engine code: OM906
				 3951.20.00	MF395	
				 3961.30.00	395GTZ	
				 8603.47.00	HHIS-3	
				3950.90.34	395 18	- Engine code: OM906
				 3952.20.00	MF395	
				 3960.30.00	395GTZ	
				 8653.47.00	HHIS-3	
				3950.90.38	395 18	- Engine code: OM906
				 3951.20.00	MF395	
				 3961.30.00	395GTZ	
				 8653.47.00	HHIS-3	
				3950.90.37	395 18	- Engine code: OM906
				 3952.20.00	MF395	
				 3960.30.00	395GTZ	
				 8602.47.00		
				3950.90.40	395 18	- Engine code: OM906
				 3951.20.00	MF395	
				 3961.30.00	395GTZ	
				 8602.47.00		
				3950.90.35	395 18	- Engine code: OM906
				 3952.20.00	MF395	
				 3960.30.00	395GTZ	
				 8601.47.00		
				3950.90.42	395 18	- Engine code: OM906
				3951.20.00	MF395	
				3961.30.00	395GTZ	
				8601.47.00		

Vehicle list

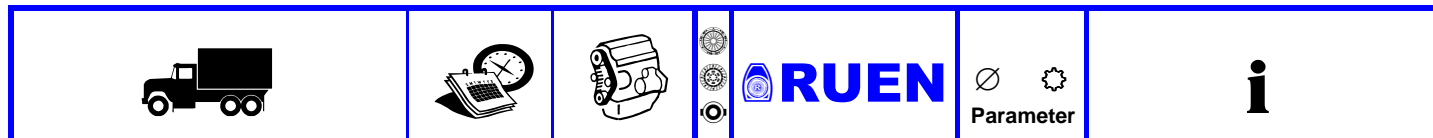

MERCEDES-BENZ

ATEGO 1315 - 1419

1328 AF 976.364, 976.363	01.98 - 10.04	OM 906.911	3950.90.03	395 18	- Engine code: OM906
1328 F 976.064, 976.065, 976.063	01.98 - 10.04		3951.20.00	MF395	
1328 LS 974.262, 974.263	01.98 - 10.04		3961.30.00	395GTZ	
1328,1328 L 970.063, 970.067, 970.068, 970.267, 970.263, 970.268, 970.065, 970.265	01.98 - 10.04		3950.90.33	395 18	- Engine code: OM906
			3951.20.00	MF395	
			3961.30.00	395GTZ	
			8603.47.00	HHIS-3	
			3950.90.38	395 18	- Engine code: OM906
			3951.20.00	MF395	
			3961.30.00	395GTZ	
			8653.47.00	HHIS-3	

Vehicle list

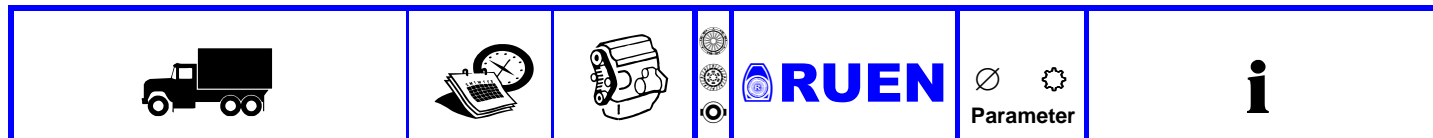







MERCEDES-BENZ

ATEGO 1315 - 1419











1315 958.026	10.04 -	OM	3620.90.02	362 18	- Engine code: OM904
1318 A 970.362, 970.363	10.04 -	904.957	3606.20.00	MF362	
1318 AK 972.362	10.04 -	OM 900.913	3627.30.00	362WG TB	
1318 K 972.062	10.04 -	OM 902.916	3620.90.32	362 18	- Engine code: OM904
1318, 1318 L 970.063, 970.067, 970.060, 970.068, 970.267, 970.263, 970.268, 970.065, 970.265	10.04 -	OM 902.917	3606.20.00	MF362	
1322 A 970.362, 970.363	10.04 -	OM 902.918	3627.30.00	362WG TB	
1322 AF 976.364	10.04 -	OM 904.949	8603.47.00	HHIS-3	
1322 AK 972.362	10.04 -	OM 904.962	3620.90.42	362 18	- Engine code: OM904
1322 F 976.064, 976.065, 976.063	10.04 -	OM 904.965	3606.20.00	MF362	
1322 K 972.062	10.04 -	OM 904.966	3627.30.00	362WG TB	
1322 LKO 975.262	10.04 -	OM 904.967	8653.47.00	HHIS-3	
1322 LS 974.262, 974.263	10.04 -	OM 904.968	3950.90.21	395 18	- Engine code: OM904
1322, 1322 L 970.063, 970.067, 970.060, 970.059, 970.068, 970.267, 970.263, 970.268, 970.065, 970.265	10.04 -	OM 904.970	3951.20.00	MF395	- Equipment Var: SA 504672/22
1323 A, 1324 A 970.362, 970.363	10.04 -	OM 904.972	3971.30.00	395WG TZ	
1323 AK 972.362	01.98 - 09.04	OM 904.973	3950.90.01	395 18	- Engine code: OM906
1323 K 972.062	01.98 - 09.04	OM 904.976	3952.20.00	MF395	
1323 LS, 1324 LS 974.262, 974.263	10.04 -	OM 906.910	3960.30.00	395GTZ	
1323, 1323 L, 1324, 1324 L 970.063, 970.067, 970.068, 970.267, 970.263, 970.268, 970.065, 970.265	10.04 -	OM 924.920	3950.90.03	395 18	- Engine code: OM906
1324 AK 972.372, 972.362	10.04 -	OM 924.922	3951.20.00	MF395	
1324 K 972.062	10.04 -	OM 924.930	3961.30.00	395GTZ	
1324 LKO 975.262	10.04 -	OM 924.989	3950.90.31	395 18	- Engine code: OM906
1324, 1324 L 970.063, 970.067, 970.068, 970.065	10.04 -	OM 925.920	3952.20.00	MF395	
1326 AF 976.364	10.04 -		3960.30.00	395GTZ	
1326 F 976.064, 976.065, 976.063	10.04 -		8603.47.00	HHIS-3	
1326 LS 974.262, 974.263	10.04 -		3950.90.33	395 18	- Engine code: OM906
1326, 1326 L 970.063, 970.067, 970.068, 970.267, 970.263, 970.268, 970.065, 970.265	10.04 -		3951.20.00	MF395	
1329 AF 976.364	10.04 -		3961.30.00	395GTZ	
1329, 1329 L 970.063, 970.067, 970.068, 970.065	10.04 -		8653.47.00	HHIS-3	
1418 958.034, 958.032, 958.030, 958.036	10.04 -		3950.90.34	395 18	- Engine code: OM906
1418 K 958.034, 958.032, 958.030	01.11 -		3952.20.00	MF395	
1419 958.034, 958.032, 958.030, 958.036	10.04 -		3960.30.00	395GTZ	
			8602.47.00	HHIS-3	
			3950.90.37	395 18	- Engine code: OM906
			3951.20.00	MF395	
			3961.30.00	395GTZ	
			8602.47.00	HHIS-3	
			3950.90.40	395 18	- Engine code: OM906
			3952.20.00	MF395	
			3960.30.00	395GTZ	
			8601.47.00	HHIS-3	
			3950.90.35	395 18	- Engine code: OM906
			3951.20.00	MF395	
			3961.30.00	395GTZ	
			8601.47.00	HHIS-3	
			3950.90.42	395 18	- Engine code: OM906
			3951.20.00	MF395	
			3961.30.00	395GTZ	
			8601.47.00	HHIS-3	

Vehicle list

				RUEN	  Parameter	
---	---	---	---	-------------	--	---

MERCEDES-BENZ

ATEGO 1315 - 1419

1328 LS, 1329 LS 974.262, 974.263 1328, 1328 L, 1329, 1329 L 970.063, 970.067, 970.068, 970.267, 970.263, 970.268, 970.065, 970.265 1329 F 976.064, 976.065, 976.063	10.04 - 10.04 - 10.04 -	OM 902.918 OM 906.911 OM 906.916	 3950.90.03  3951.20.00  3961.30.00	395 18 MF395 395GTZ	- Engine code: OM906
			 3950.90.33  3951.20.00  3961.30.00  8603.47.00	395 18 MF395 395GTZ HHIS-3	- Engine code: OM906
			 3950.90.38  3951.20.00  3961.30.00  8653.47.00	395 18 MF395 395GTZ HHIS-3	- Engine code: OM906

Vehicle list

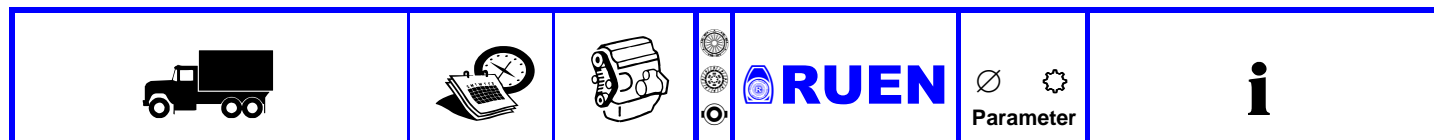







MERCEDES-BENZ

ATEGO 1517 - 1729











1517 A 970.373	01.98 - 10.04	OM 904.911		3620.90.02	362 18	- Engine code: OM904
1517 K 972.072	01.98 - 10.04	OM 906.910		3606.20.00	MF362	
1517,1517 L 970.078, 375.122, 970.275	01.98 - 10.04	OM 906.919		3627.30.00	362WG7B	
375.121, 970.073, 970.075, 970.077, 970.273, 970.277, 970.278				3620.90.32	362 18	- Engine code: OM904
1523 A 970.373	01.98 - 10.04			3606.20.00	MF362	
1523 AK 972.372	01.98 - 10.04			3627.30.00	362WG7B	
1523 K 972.072	01.98 - 10.04			8603.47.00	HHIS-3	
1523 KO	01.98 - 10.04			3620.90.42	362 18	- Engine code: OM904
	01.98 - 10.04			3606.20.00	MF362	
	01.98 - 10.04			3627.30.00	362WG7B	
1523,1523 L 970.078, 970.275, 970.073	01.98 - 10.04			8653.47.00	HHIS-3	
970.075, 970.077, 970.273, 970.277, 970.278				3950.90.21	395 18	- Engine code: OM904
1525 AF 976.374, 976.373	01.98 - 10.04			3951.20.00	MF395	- Equipment Var: SA 504672/22
				3971.30.00	395WG7Z	
				3950.90.01	395 18	- Engine code: OM906
				3952.20.00	MF395	
				3960.30.00	395GTZ	
				3950.90.03	395 18	- Engine code: OM906
				3951.20.00	MF395	
				3961.30.00	395GTZ	
				3950.90.31	395 18	- Engine code: OM906
				3952.20.00	MF395	
				3960.30.00	395GTZ	
				8603.47.00	HHIS-3	
				3950.90.33	395 18	- Engine code: OM906
				3951.20.00	MF395	
				3961.30.00	395GTZ	
				8603.47.00	HHIS-3	
				3950.90.34	395 18	- Engine code: OM906
				3952.20.00	MF395	
				3960.30.00	395GTZ	
				8653.47.00	HHIS-3	
				3950.90.38	395 18	- Engine code: OM906
				3951.20.00	MF395	
				3961.30.00	395GTZ	
				8653.47.00	HHIS-3	
				3950.90.37	395 18	- Engine code: OM906
				3952.20.00	MF395	
				3960.30.00	395GTZ	
				8602.47.00		
				3950.90.40	395 18	- Engine code: OM906
				3951.20.00	MF395	
				3961.30.00	395GTZ	
				8602.47.00		
				3950.90.35	395 18	- Engine code: OM906
				3952.20.00	MF395	
				3960.30.00	395GTZ	
				8601.47.00		
				3950.90.42	395 18	- Engine code: OM906
				3951.20.00	MF395	
				3961.30.00	395GTZ	
				8601.47.00		

Vehicle list

				RUEN	 Parameter	
---	---	---	---	-------------	--	---

MERCEDES-BENZ

ATEGO 1517 - 1729

1528 AF 976.374, 976.373 1528 F 976.077, 976.075 1528,1528 L 970.078, 970.275, 970.073, 970.075, 970.077, 970.273, 970.277, 970.278	01.98 - 10.04 01.98 - 10.04 01.98 - 10.04	OM 906.911	<ul style="list-style-type: none">  3950.90.03  3951.20.00  3961.30.00 	395 18 MF395 395GTZ	- Engine code: OM906
			<ul style="list-style-type: none">  3950.90.33  3951.20.00  3961.30.00  8603.47.00 	395 18 MF395 395GTZ HHIS-3	- Engine code: OM906
			<ul style="list-style-type: none">  3950.90.38  3951.20.00  3961.30.00  8653.47.00 	395 18 MF395 395GTZ HHIS-3	- Engine code: OM906

Vehicle list

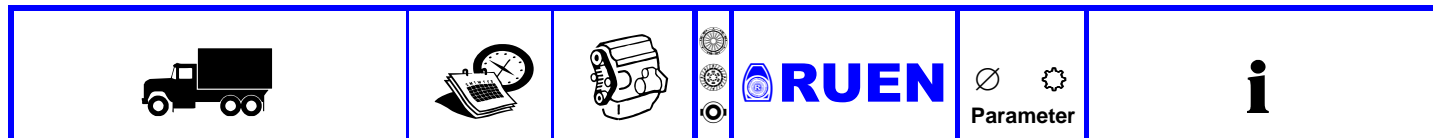







MERCEDES-BENZ

ATEGO 1517 - 1729



























1517 AK 972.372	01.98 - 10.04	OM 900.913		3620.90.02	362 18	- Engine code: OM904
1518 A 970.373	10.04 -	OM 902.916		3606.20.00	MF362	
1518 AK 972.372	10.04 -	OM 902.917		3627.30.00	362WG7B	
1518 K 972.072	10.04 -	OM 902.918		3620.90.32	362 18	- Engine code: OM904
1518, 1518 L	10.04 -	OM 904.911		3606.20.00	MF362	
1522 A 970.372, 970.373	10.04 -	OM 904.917		3627.30.00	362WG7B	
1522 AF 976.374, 976.373	10.04 -	OM 904.962		8603.47.00	HHIS-3	
1522 AK 972.372	10.04 -	OM 904.967		3620.90.42	362 18	- Engine code: OM904
1522 F 976.077, 976.075	10.04 -	OM 904.968		3606.20.00	MF362	
1522 K 972.072	10.04 -	OM 904.972		3627.30.00	362WG7B	
1522, 1522 L 970.078, 970.275, 970.073, 970.075, 970.077, 970.273, 970.277, 970.278	10.04 -	OM 904.973		8653.47.00	HHIS-3	
1523 A, 1524 A 970.372, 970.373	10.04 -	OM 904.976		3950.90.21	395 18	- Engine code: OM904 - Equipment Var: SA 504672/22
1523 K, 1524 K 972.072	01.98 - 10.04	OM 906.910		3951.20.00	MF395	
1523, 1523 L, 1524, 1524 L 970.078, 970.275, 970.073, 970.075, 970.077, 970.273, 970.277, 970.278	10.04 -	OM 906.911		3971.30.00	395WG7Z	
1524 AK 972.372, 972.362	10.04 -	OM 906.915		3950.90.01	395 18	- Engine code: OM906
1524, 1524 L 970.078, 970.073, 970.075, 970.077	10.04 -	OM 906.916		3952.20.00	MF395	
1526 AF 976.374, 976.373	10.04 -	OM 906.919		3960.30.00	395GTZ	
1526 AK 972.372	10.04 -	OM 906.983		3950.90.03	395 18	- Engine code: OM906
1526 K 972.072	10.04 -	OM 906.985		3951.20.00	MF395	
1526, 1526 L 970.078, 970.275, 970.073, 970.075, 970.077, 970.273, 970.277, 970.278	10.04 -	OM 906.988		3961.30.00	395GTZ	
1526 AF 976.374, 976.373	10.04 -	OM 906.990		3950.90.31	395 18	- Engine code: OM906
1526 AK 972.372	10.04 -	OM 924.920		3952.20.00	MF395	
1526 K 972.072	10.04 -	OM 924.922		3960.30.00	395GTZ	
1526, 1526 L 970.078, 970.275, 970.073, 970.075, 970.077, 970.273, 970.277, 970.278	10.04 -	OM 924.924		8603.47.00	HHIS-3	
1526, 1526 L 970.078, 970.073, 970.075, 970.077	10.04 -	OM 924.930		3950.90.33	395 18	- Engine code: OM906
1528 AK 972.372	01.98 - 09.04	OM 924.989		3951.20.00	MF395	
1528 K 972.072	01.98 - 09.04	OM 925.920		3961.30.00	395GTZ	
1529 AF 976.374, 976.373	10.04 -	OM 926.941		8603.47.00	HHIS-3	
1529 F 976.077, 976.075	10.04 -			3950.90.34	395 18	- Engine code: OM906
1529, 1529 L 970.078, 970.073, 970.075, 970.077	10.04 -			3952.20.00	MF395	
1618	10.04 -			3960.30.00	395GTZ	
1618 K	10.04 -			8653.47.00	HHIS-3	
1622	10.04 -			3950.90.38	395 18	- Engine code: OM906
1622 K	10.04 -			3951.20.00	MF395	
1624	10.04 -			3961.30.00	395GTZ	
1624 K	10.04 -			8653.47.00	HHIS-3	
1629	10.04 -			3950.90.37	395 18	- Engine code: OM906
1718	10.04 -			3952.20.00	MF395	
1718 K	01.11 -			3960.30.00	395GTZ	
1719 958.076, 958.072, 958.074, 958.070	10.04 -			8602.47.00		
1722 958.076, 958.072, 958.074, 958.070	10.04 -			3950.90.40	395 18	- Engine code: OM906
1725 958.076, 958.072, 958.074, 958.070	10.04 -			3951.20.00	MF395	
1725 A 958.078	10.06 -			3961.30.00	395GTZ	
1725 K 958.072, 958.074, 958.070	01.11 -			8601.47.00		
1725 S 958.077	01.07 -			3950.90.35	395 18	- Engine code: OM906
1728	06.07 -			3952.20.00	MF395	
1728 S 958.077, 7201cc	01.07 -			3960.30.00	395GTZ	
				8601.47.00		

Vehicle list



























					
---	---	---	--	---	---

MERCEDES-BENZ







ATEGO 1517 - 1729

1528, 1528 L, 1529, 1529 L 970.078, 970.275, 970.073, 970.075, 970.077, 970.273, 970.277, 970.278 1529 AK 972.372 1529 K 972.072	10.04 -	OM 902.918 OM 906.911 OM 906.916	 3950.90.03	395 18	- Engine code: OM906
	10.04 -		 3951.20.00	MF395	
	10.04 -		 3961.30.00	395GTZ	
			 3950.90.33	395 18	- Engine code: OM906
			 3951.20.00	MF395	
			 3961.30.00	395GTZ	
			 8603.47.00	HHIS-3	
			 3950.90.38	395 18	- Engine code: OM906
			 3951.20.00	MF395	
			 3961.30.00	395GTZ	
			 8653.47.00	HHIS-3	
1728 S 958.077, 6374cc	01.07 -	OM 906.921 OM 906.986	 3950.90.03	395 18	- Engine code: OM906LA
			 3951.20.00	MF395	
			 3961.30.00	395GTZ	
			 8603.47.00	HHIS-3	
			 3950.90.33	395 18	- Engine code: OM906LA
			 3951.20.00	MF395	
			 3961.30.00	395GTZ	
			 8603.47.00	HHIS-3	
			 3950.90.38	395 18	- Engine code: OM906LA
			 3951.20.00	MF395	
			 3961.30.00	395GTZ	
			 8653.47.00	HHIS-3	
			 4300.90.78 ⊕	430 18	- Equipment Var: SA504682-09
			 4318.60.00	MFZ430	- Engine code: OM906LA
			 4351.30.00	430WGTZ	

ATEGO 1823 - 1929

























1823 AK 952.563, 952.562 1823 K 952.503, 952.502 1823 LS 954.532 1823, 1823 L	05.98 - 09.04	OM 906.920 OM 906.922 OM 906.925	 3950.90.01	395 18	- Engine code: OM906LA
	05.98 - 09.04		 3952.20.00	MF395	
	05.98 - 09.04		 3960.30.00	395GTZ	
	01.98 - 09.04		 3950.90.03	395 18	- Engine code: OM906LA
			 3951.20.00	MF395	
			 3961.30.00	395GTZ	
			 8603.47.00	HHIS-3	
			 3950.90.31	395 18	- Engine code: OM906LA
			 3952.20.00	MF395	
			 3960.30.00	395GTZ	
			 8603.47.00	HHIS-3	
			 3950.90.33	395 18	- Engine code: OM906LA
			 3951.20.00	MF395	
			 3961.30.00	395GTZ	
			 8603.47.00	HHIS-3	
			 3950.90.34	395 18	- Engine code: OM906LA
			 3952.20.00	MF395	
			 3960.30.00	395GTZ	
			 8653.47.00	HHIS-3	
			 3950.90.38	395 18	- Engine code: OM906LA
			 3951.20.00	MF395	
			 3961.30.00	395GTZ	
			 8653.47.00	HHIS-3	
			 4300.90.78 ⊕	430 18	- Engine code: OM906LA
			 4318.60.00	MFZ430	- Equipment Var: SA504682-09
			 4351.30.00	430WGTZ	

Vehicle list

					
---	---	---	--	---	---

MERCEDES-BENZ

ATEGO 1823 - 1929

1828 A 950.562, 950.563 1828 AK 952.563, 952.562 1828 K 952.503, 952.502 1828 LS 954.532 1828, 1828 L	05.98 - 09.04 05.98 - 09.04 05.98 - 09.04 05.98 - 09.04 05.98 - 09.04	OM 906.921 OM 906.923 OM 906.926	 3950.90.03	395 18	- Engine code: OM906LA
			 3951.20.00	MF395	
			 3961.30.00	395GTZ	
			 3950.90.33	395 18	- Engine code: OM906LA
			 3951.20.00	MF395	
			 3961.30.00	395GTZ	
			 8603.47.00	HHIS-3	
			 3950.90.38	395 18	- Engine code: OM906LA
			 3951.20.00	MF395	
			 3961.30.00	395GTZ	
			 8653.47.00	HHIS-3	
			 4300.90.78 ⊕	430 18	- Engine code: OM906LA - Equipment Var: SA504682-09
			 4318.60.00	MFZ430	
			 4351.30.00	430WGTZ	
1923 L 970.667, 970.663, 970.665 1928 L 970.667, 970.663, 970.665	04.98 - 10.04 04.98 - 10.04	OM 906.910 OM 906.911 OM 906.915 OM 906.916	 3950.90.03	395 18	- Engine code: OM906LA
			 3951.20.00	MF395	
			 3961.30.00	395GTZ	
			 3950.90.33	395 18	- Engine code: OM906LA
			 3951.20.00	MF395	
			 3961.30.00	395GTZ	
			 8603.47.00	HHIS-3	
			 3950.90.38	395 18	- Engine code: OM906LA
			 3951.20.00	MF395	
			 3961.30.00	395GTZ	
			 8653.47.00	HHIS-3	

Vehicle list



MERCEDES-BENZ

ATEGO 1823 - 1929

1924 L 970.667, 970.663, 970.665, 6x2/4	10.04 -	OM 902.916		3620.90.02	362 18	- Engine code: OM904
1924 L 970.667, 970.663, 970.66, 4x2	10.04 -	OM 902.917		3606.20.00	MF362	
1926 L 970.667, 970.663, 970.665, 4x2	10.04 -	OM 902.918		3627.30.00	362WG7B	
1926 L 970.667, 970.663, 970.665, 6x2/4	10.04 -			3620.90.32	362 18	- Engine code: OM904
1929 L 970.667, 970.663, 970.665, 6x2/4	10.04 -			3606.20.00	MF362	
1929 L 970.667, 970.663, 970.665, 6x2/4	10.04 -			3627.30.00	362WG7B	
1929 L 970.667, 970.663, 970.665	10.04 -			8603.47.00	HHIS-3	
				3620.90.42	362 18	- Engine code: OM904
				3606.20.00	MF362	
				3627.30.00	362WG7B	
				8653.47.00	HHIS-3	
				3950.90.21	395 18	- Engine code: OM904
				3951.20.00	MF395	- Equipment Var: SA 504672/22
				3971.30.00	395WG7Z	
				3950.90.01	395 18	- Engine code: OM906
				3952.20.00	MF395	
				3960.30.00	395GTZ	
				3950.90.03	395 18	- Engine code: OM906
				3951.20.00	MF395	
				3961.30.00	395GTZ	
				3950.90.31	395 18	- Engine code: OM906
				3952.20.00	MF395	
				3960.30.00	395GTZ	
				8603.47.00	HHIS-3	
				3950.90.33	395 18	- Engine code: OM906
				3951.20.00	MF395	
				3961.30.00	395GTZ	
				8603.47.00	HHIS-3	
				3950.90.34	395 18	- Engine code: OM906
				3952.20.00	MF395	
				3960.30.00	395GTZ	
				8653.47.00	HHIS-3	
				3950.90.38	395 18	- Engine code: OM906
				3951.20.00	MF395	
				3961.30.00	395GTZ	
				8653.47.00	HHIS-3	
				3950.90.37	395 18	- Engine code: OM906
				3952.20.00	MF395	
				3960.30.00	395GTZ	
				8602.47.00		
				3950.90.40	395 18	- Engine code: OM906
				3951.20.00	MF395	
				3961.30.00	395GTZ	
				8602.47.00		
				3950.90.35	395 18	- Engine code: OM906
				3952.20.00	MF395	
				3960.30.00	395GTZ	
				8601.47.00		
				3950.90.42	395 18	- Engine code: OM906
				3951.20.00	MF395	
				3961.30.00	395GTZ	
				8601.47.00		

Vehicle list

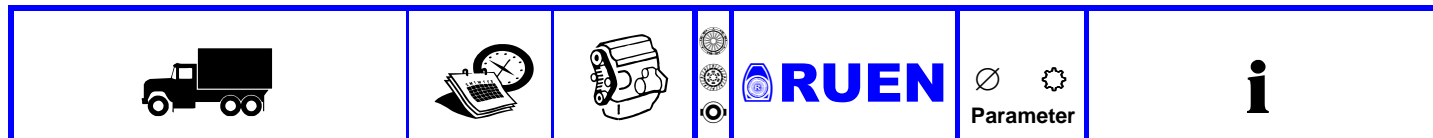

MERCEDES-BENZ

ATEGO 2223 - 2530

2523 L 950.624 2528 L 950.624, 950.602, 950.603, 950.625, 950.604, 950.613, 950.623, 950.605, 950.614, 950.626	04.98 - 10.04 04.98 - 10.04	OM 906.920 OM 906.921 OM 906.926	3950.90.03	395 18	- Engine code: OM906LA
			3951.20.00 3961.30.00	MF395 395GTZ	
			3950.90.33	395 18	- Engine code: OM906LA
			3951.20.00 3961.30.00 8603.47.00	MF395 395GTZ HHIS-3	
			3950.90.38	395 18	- Engine code: OM906LA
			3951.20.00 3961.30.00 8653.47.00	MF395 395GTZ HHIS-3	
			4300.90.78 ⊕	430 18	- Equipment Var: SA504682-09 - Engine code: OM906LA
			4318.60.00 4351.30.00	MFZ430 430WGTZ	
2223 L 970.673, 970.677, 970.675 2228 L 970.673, 970.677, 970.675 2528 L 950.624, 950.602, 950.603, 950.625, 950.604, 950.613, 950.623, 950.605, 950.614, 950.626	04.98 - 10.04 04.98 - 10.04 04.98 - 10.04	OM 906.910 OM 906.911 OM 906.915 OM 906.916 OM 906.921 OM 906.926	3950.90.03	395 18	- Engine code: OM906LA
			3951.20.00 3961.30.00	MF395 395GTZ	
			3950.90.33	395 18	- Engine code: OM906LA
			3951.20.00 3961.30.00 8603.47.00	MF395 395GTZ HHIS-3	
			3950.90.38	395 18	- Engine code: OM906LA
			3951.20.00 3961.30.00 8653.47.00	MF395 395GTZ HHIS-3	
			4300.90.78 ⊕	430 18	- Equipment Var: SA504682-09 - Engine code: OM906LA
			4318.60.00 4351.30.00	MFZ430 430WGTZ	

Vehicle list









MERCEDES-BENZ

ATEGO 2223 - 2530

















































2224 L 970.673, 970.677, 970.675, 6x2/4	10.04 -	OM 902.915		3620.90.32	362 18	- Engine code: OM904
2226 L 970.673, 970.677, 970.675, 4x2	10.04 -	OM 902.916		3606.20.00	MF362	
2226 L 970.673, 970.677, 970.675, 6x2/4	10.04 -	OM 902.917		3627.30.00	362WGTB	
2229 L 970.673, 970.677, 970.675, 4x2	10.04 -	OM 902.918		8603.47.00	HHIS-3	
2229 L 970.673, 970.677, 970.675, 6x2/4	10.04 -	OM 906.919		3620.90.42	362 18	- Engine code: OM904
2422 958.092, 958.090, 958.094, 958.096	10.04 -	OM 906.921		3606.20.00	MF362	
2428 958.092, 958.090, 958.094, 958.096, 7201cc	10.04 -	OM 906.983		3627.30.00	362WGTB	
2428 958.092, 958.090, 958.094, 958.09, 6374cc	10.04 -	OM 906.985		8653.47.00	HHIS-3	
2529 L 970.673, 970.677, 970.675	10.04 -	OM 906.986		3950.90.21	395 18	- Engine code: OM904
	10.04 -	OM 906.988		3951.20.00	MF395	- Equipment Var: SA 504672/22
	10.04 -	OM 906.990		3971.30.00	395WGTZ	
	10.04 -	OM 924.924		3950.90.01	395 18	- Engine code: OM906
	10.04 -	OM 926.941		3952.20.00	MF395	
				3960.30.00	395GTZ	
				3950.90.31	395 18	- Engine code: OM906
				3952.20.00	MF395	
				3960.30.00	395GTZ	
				8603.47.00	HHIS-3	
				3950.90.33	395 18	- Engine code: OM906
				3951.20.00	MF395	
				3961.30.00	395GTZ	
				8603.47.00	HHIS-3	
				3950.90.34	395 18	- Engine code: OM906
				3952.20.00	MF395	
				3960.30.00	395GTZ	
				8653.47.00	HHIS-3	
				3950.90.38	395 18	- Engine code: OM906
				3951.20.00	MF395	
				3961.30.00	395GTZ	
				8653.47.00	HHIS-3	
				3950.90.36	395 18	- Engine code: OM906
				3952.20.00	MF395	- Equipment Var: SA 504673/26
				3960.30.00	395GTZ	
				8604.47.00		
				3950.90.39	395 18	- Engine code: OM906
				3951.20.00	MF395	- Equipment Var: SA 504673/26
				3961.30.00	395GTZ	
				8604.47.00		
				3950.90.37	395 18	- Engine code: OM906
				3952.20.00	MF395	
				3960.30.00	395GTZ	
				8602.47.00		
				3950.90.40	395 18	- Engine code: OM906
				3951.20.00	MF395	
				3961.30.00	395GTZ	
				8602.47.00		
				3950.90.35	395 18	- Engine code: OM906
				3952.20.00	MF395	
				3960.30.00	395GTZ	
				8601.47.00		
				3950.90.42	395 18	- Engine code: OM906
				3951.20.00	MF395	
				3961.30.00	395GTZ	
				8601.47.00		

Vehicle list

					
---	---	---	--	---	---

MERCEDES-BENZ

ATEGO 2223 - 2530











2224 L 970.673, 970.677, 970.675, 4x2	10.04 -	OM 902.916		3620.90.32  3606.20.00  3627.30.00  8603.47.00	362 18 MF362 362WGTB HHIS-3	- Engine code: OM904
				3620.90.42  3606.20.00  3627.30.00  8653.47.00	362 18 MF362 362WGTB HHIS-3	- Engine code: OM904
				3950.90.21  3951.20.00  3971.30.00	395 18 MF395 395WGTZ	- Engine code: OM904 - Equipment Var: SA 504672/22
				3950.90.01  3952.20.00  3960.30.00	395 18 MF395 395GTZ	- Engine code: OM906
				3950.90.03  3951.20.00  3961.30.00	395 18 MF395 395GTZ	- Engine code: OM906
				3950.90.31  3952.20.00  3960.30.00  8603.47.00	395 18 MF395 395GTZ HHIS-3	- Engine code: OM906
				3950.90.33  3951.20.00  3961.30.00  8603.47.00	395 18 MF395 395GTZ HHIS-3	- Engine code: OM906
				3950.90.34  3952.20.00  3960.30.00  8653.47.00	395 18 MF395 395GTZ HHIS-3	- Engine code: OM906
				3950.90.38  3951.20.00  3961.30.00  8653.47.00	395 18 MF395 395GTZ HHIS-3	- Engine code: OM906
				3950.90.37  3952.20.00  3960.30.00  8602.47.00	395 18 MF395 395GTZ	- Engine code: OM906
				3950.90.40  3951.20.00  3961.30.00  8602.47.00	395 18 MF395 395GTZ	- Engine code: OM906
				3950.90.35  3952.20.00  3960.30.00  8601.47.00	395 18 MF395 395GTZ	- Engine code: OM906
				3950.90.42  3951.20.00  3961.30.00  8601.47.00	395 18 MF395 395GTZ	- Engine code: OM906

Vehicle list

			 RUEN	 Parameter	
---	---	---	--	--	---























MERCEDES-BENZ

ATEGO 2628 -

2628 950.642, 950.643 2628 B 953.641, 953.643 2628 K 952.642, 952.641, 952.643	04.98 - 10.04 04.98 - 10.04 04.98 - 10.04	OM 906.921	 3950.90.03  3951.20.00  3961.30.00	395 18 MF395 395GTZ	- Engine code: OM906LA
			 3950.90.33  3951.20.00  3961.30.00  8603.47.00	395 18 MF395 395GTZ HHIS-3	- Engine code: OM906LA
			 3950.90.38  3951.20.00  3961.30.00  8653.47.00	395 18 MF395 395GTZ HHIS-3	- Engine code: OM906LA

AXOR 1823 - 2044

01.02 -

1823 375.301 1823 K 375.303	01.02 - 10.04 01.02 - 10.04	OM 906.920	 3950.90.01  3952.20.00  3960.30.00	395 18 MF395 395GTZ	- Equipment Var: SA531129-01
			 3950.90.03  3951.20.00  3961.30.00	395 18 MF395 395GTZ	- Equipment Var: SA531129-02
			 3950.90.31  3952.20.00  3960.30.00  8603.47.00	395 18 MF395 395GTZ HHIS-3	
			 3950.90.33  3951.20.00  3961.30.00  8603.47.00	395 18 MF395 395GTZ HHIS-3	
			 3950.90.34  3952.20.00  3960.30.00  8653.47.00	395 18 MF395 395GTZ HHIS-3	
			 3950.90.38  3951.20.00  3961.30.00  8653.47.00	395 18 MF395 395GTZ HHIS-3	

Vehicle list

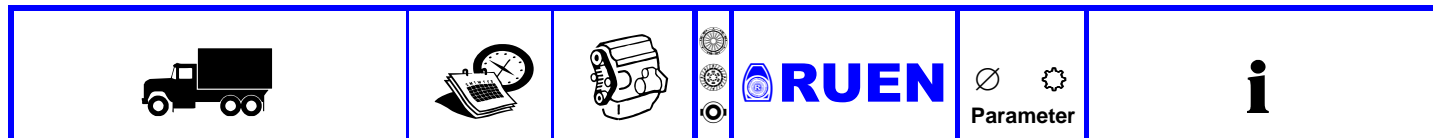

MERCEDES-BENZ

AXOR 1823 - 2044

01.02 -

1824 A	10.04 -	OM 906.921		3620.90.32	362 18	- Engine code: OM904
1828 LS 954.532	10.04 -	OM 926.921		3606.20.00	MF362	
1933 958.207	10.04 -	OM 926.990		3627.30.00	362WG TB	
1933 S 958.207, 958.203	01.11 -			8603.47.00	HHIS-3	
				3620.90.42	362 18	- Engine code: OM904
				3606.20.00	MF362	
				3627.30.00	362WG TB	
				8653.47.00	HHIS-3	
				3950.90.21	395 18	- Engine code: OM904 - Equipment Var: SA 504672/22
				3951.20.00	MF395	
				3971.30.00	395WG TZ	
				3950.90.01	395 18	- Engine code: OM906
				3952.20.00	MF395	
				3960.30.00	395GTZ	
				3950.90.03	395 18	- Engine code: OM906
				3951.20.00	MF395	
				3961.30.00	395GTZ	
				3950.90.31	395 18	- Engine code: OM906
				3952.20.00	MF395	
				3960.30.00	395GTZ	
				8603.47.00	HHIS-3	
				3950.90.33	395 18	- Engine code: OM906
				3951.20.00	MF395	
				3961.30.00	395GTZ	
				8603.47.00	HHIS-3	
				3950.90.34	395 18	- Engine code: OM906
				3952.20.00	MF395	
				3960.30.00	395GTZ	
				8653.47.00	HHIS-3	
				3950.90.38	395 18	- Engine code: OM906
				3951.20.00	MF395	
				3961.30.00	395GTZ	
				8653.47.00	HHIS-3	
				3950.90.36	395 18	- Engine code: OM906 - Equipment Var: SA 504673/26
				3952.20.00	MF395	
				3960.30.00	395GTZ	
				8604.47.00		
				3950.90.39	395 18	- Engine code: OM906 - Equipment Var: SA 504673/26
				3951.20.00	MF395	
				3961.30.00	395GTZ	
				8604.47.00		
				3950.90.37	395 18	- Engine code: OM906
				3952.20.00	MF395	
				3960.30.00	395GTZ	
				8602.47.00		
				3950.90.40	395 18	- Engine code: OM906
				3951.20.00	MF395	
				3961.30.00	395GTZ	
				8602.47.00		
				3950.90.35	395 18	- Engine code: OM906
				3952.20.00	MF395	
				3960.30.00	395GTZ	
				8601.47.00		
				3950.90.42	395 18	- Engine code: OM906
				3951.20.00	MF395	
				3961.30.00	395GTZ	
				8601.47.00		

Vehicle list



MERCEDES-BENZ

AXOR 1823 - 2044 01.02 -

1823, 1823 L, 1824, 1824 L, LL	10.04 -	OM 902.913	3950.90.01	395 18	- Engine code: OM906LA
1823 AK, 1824 AK 952.563, 952.562	10.04 -	OM 902.914	3952.20.00	MF395	
1823 LS, 1824 LS 954.532	10.04 -	OM 902.915	3960.30.00	395GTZ	
1823 K, 1823 KL, 1824 K 952.503, 952.502	10.04 -	OM 902.930	3950.90.03	395 18	- Engine code: OM906LA
1826, 1826 L, LL	10.04 -	OM 902.931	3951.20.00	MF395	
1826 AK 952.563, 952.562	10.04 -	OM 902.932	3961.30.00	395GTZ	
1826 K 952.503, 952.502	10.04 -	OM 906.920	3950.90.34	395 18	- Engine code: OM906LA
1826 LS 954.532	10.04 -	OM 906.921	3952.20.00	MF395	
1828, 1828 L, 1829, 1829 L, LL	10.04 -	OM 906.922	3960.30.00	395GTZ	
1828 A, 1829 A 950.562, 950.563	10.04 -	OM 906.923	8653.47.00	HHIS-3	
1828 AK, 1829 AK 952.563, 374.557, 952.562	10.04 -	OM 906.925	3950.90.31	395 18	- Engine code: OM906LA
1828 K, 1828 KL, 1829 K 952.503, 952.502, 374.554	10.04 -	OM 906.926	3952.20.00	MF395	
1829 LS 954.532	10.04 -	OM 906.927	3960.30.00	395GTZ	
1833, 1833 L, LL	10.04 -	OM 906.928	8603.47.00	HHIS-3	
1833 A 950.562, 950.563	10.04 -	OM 926.913	3950.90.38	395 18	- Engine code: OM906LA
1833 AK 952.563, 952.562	10.04 -	OM 926.917	3951.20.00	MF395	
1833 K 952.503, 952.502	10.04 -	OM 926.937	3961.30.00	395GTZ	
1833 LS 954.532	10.04 -	OM 926.945	8653.47.00	HHIS-3	
			3950.90.33	395 18	- Engine code: OM906LA
			3951.20.00	MF395	
			3961.30.00	395GTZ	
			8603.47.00	HHIS-3	
			3950.90.36	395 18	- Engine code: OM906LA - Equipment Var: SA504673/30
			3952.20.00	MF395	
			3960.30.00	395GTZ	
			8604.47.00		
			3950.90.39	395 18	- Engine code: OM906LA - Equipment Var: SA504673/30
			3951.20.00	MF395	
			3961.30.00	395GTZ	
			8604.47.00		
			3950.90.37	395 18	- Engine code: OM906LA
			3952.20.00	MF395	
			3960.30.00	395GTZ	
			8602.47.00		
			3950.90.40	395 18	- Engine code: OM906LA
			3951.20.00	MF395	
			3961.30.00	395GTZ	
			8602.47.00		
			3950.90.35	395 18	- Engine code: OM906LA
			3952.20.00	MF395	
			3960.30.00	395GTZ	
			8601.47.00		
			3950.90.42	395 18	- Engine code: OM906LA
			3951.20.00	MF395	
			3961.30.00	395GTZ	
			8601.47.00		
			4300.90.78 ⊕	430 18	- Engine code: OM906LA
			4318.60.00	MFZ430	
			4351.30.00	430WGTZ	
			4300.90.90 ⊕	430 18	- Engine code: OM906LA
			4340.60.00	MFZ430	
			4350.30.00	430WGTZ	
			3950.90.21	395 18	- Engine code: OM906LA, OM926LA - Equipment Var: SA504672/21/22
			3951.20.00	MF395	
			3971.30.00	395WGTZ	

Vehicle list

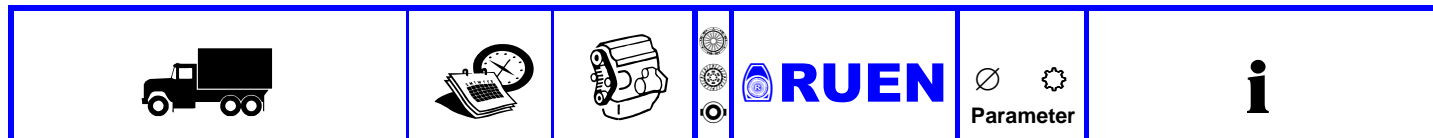

MERCEDES-BENZ

AXOR 1823 - 2044

01.02 -

1835 LS 944.032, 375.408, 944.033	01.02 - 10.04	OM 457.910		4300.90.15 ⊕	430 18	- Equipment Var: SA 531129-04/05
1836 LS, LLS 944.032, 944.033	10.04 -	OM 457.917		4329.60.00	MFZ430	
1840 LS 944.032, 375.408, 944.033	01.02 - 10.04	OM 457.918		4318.30.00	430WGTZ	
1840 LS, LLS 944.032, 374.651, 944.033	10.04 -	OM 457.937		4300.90.90 ⊕	430 18	- Equipment Var: SA 504682-24
1843 LS 944.032, 375.408, 944.033	01.02 - 10.04	OM 457.940		4340.60.00	MFZ430	
1843 LS, LLS 944.032, 944.033	10.04 -	OM 457.948		4350.30.00	430WGTZ	
1835 LS 944.032, 944.033	01.11 -	OM 457.955				
2035 S, 2036 S, LS 958.433, 958.431	01.11 -	OM 457.980				
2040 S, 2041 S, LS 958.433, 958.431	01.11 -					
2044 S 958.433, 958.431	01.11 -					

AXOR 2523 - 2544

01.02 -

2436 LS, 2536 LS 944.235	10.04 -	OM 457.918		4300.90.15 ⊕	430 18	- Equipment Var: SA 531129-04/05
2440 LS, 2540 LS 944.235	10.04 -	OM 457.937		4329.60.00	MFZ430	
2443 LS, 2543 LS 944.235	10.04 -	OM 457.948		4318.30.00	430WGTZ	
2535 LS 944.233	01.02 - 10.04	OM 457.980		4300.90.90 ⊕	430 18	- Equipment Var: SA 504682-24
2535 S, 2535 LS 958.461	10.04 -	OM 457.981		4340.60.00	MFZ430	
2540 LS 944.233	01.02 - 10.04			4350.30.00	430WGTZ	
2543 LS 944.233	01.02 - 10.04					
2544 S, 2544 LS	10.04 -					
2523 375.321	01.02 - 10.04	OM 906.920		3950.90.01	395 18	- Equipment Var: SA531129-01
2523 375.322	01.11 -	OM 906.921		3952.20.00	MF395	
2523 K 375.323	01.02 - 10.04			3960.30.00	395GTZ	
2528 375.321, 375.322	01.02 - 10.04			3950.90.03	395 18	- Equipment Var: SA531129-02
2528 K, 2528 KL 375.323	01.11 -			3951.20.00	MF395	
				3961.30.00	395GTZ	
				3950.90.31	395 18	
				3952.20.00	MF395	
				3960.30.00	395GTZ	
				8603.47.00	HHIS-3	
				3950.90.33	395 18	
				3951.20.00	MF395	
				3961.30.00	395GTZ	
				8603.47.00	HHIS-3	
				3950.90.34	395 18	
				3952.20.00	MF395	
				3960.30.00	395GTZ	
				8653.47.00	HHIS-3	
				3950.90.38	395 18	
				3951.20.00	MF395	
				3961.30.00	395GTZ	
				8653.47.00	HHIS-3	

Vehicle list

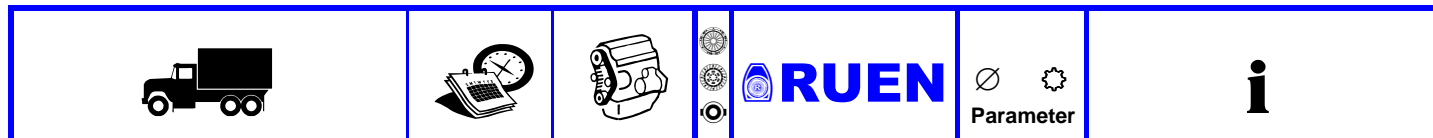

MERCEDES-BENZ

AXOR 2523 - 2544

01.02 -

2528 950.624, 950.625, 950.623, 950.626 2528 L, 2529 L 950.601, 950.602, 950.603, 950.604, 950.613, 950.605, 950.607, 950.608, 950.614, 950.606 2528 L, 2529 L 950.601, 950.602, 950.603, 950.604, 950.613, 950.605, 950.607, 950.608, 950.614, 950.606 2533 950.624, 950.625, 950.623, 950.626 2533, 2533 L, 6x2 2533, 2533 L, 6x2/4	01.04 -	OM 902.915	3950.90.03	395 18	- Engine code: OM906LA
	10.04 -	OM 906.921	3951.20.00 3961.30.00	MF395 395GTZ	
	10.04 -	OM 906.926 OM 906LA	3950.90.33	395 18	- Engine code: OM906LA
	10.04 -	OM 926.913 OM 926.919	3951.20.00 3961.30.00 8603.47.00	MF395 395GTZ HHIS-3	
	10.04 -	OM 926.921 OM 926.945 OM 926.990	3950.90.38	395 18	- Engine code: OM906LA
	10.04 -		4300.90.78 ⊕ 4318.60.00 4351.30.00	430 18 MFZ430 430WGTZ	- Equipment Var: SA504682-09 - Engine code: OM906LA
2535 L, 2536 L, 2536 LL 940.205, 940.203, 940.204 2540 L, LL 940.205, 940.203, 940.204 2540 S, 2541 S, LS 958.461 2543 L, LL 940.205, 940.203, 940.204 2543 S, 2543 LS 944.233	10.04 -	OM 457.918	4300.90.15 ⊕	430 18	- Equipment Var: SA 531129-04/05
	10.04 -	OM 457.937	4329.60.00 4318.30.00	MFZ430 430WGTZ	
	10.04 -	OM 457.948	4300.90.90 ⊕	430 18	- Equipment Var: SA 504682-24
	10.04 -	OM 457.980	4340.60.00 4350.30.00	MFZ430 430WGTZ	
	10.04 -		4000.90.04	400 18	- Vehicles with double disc clutch - Equipment Var: SA 504682 13
			4025.10.00 4025.30.00	MFZ2/400X 400WGTZ	

AXOR 2623 - 2831

09.01 -

2628 B, 2629 B 953.641, 953.643	10.04 -	OM 906 OM 906LA OM 926 941	3950.90.01	395 18	
			3952.20.00 3960.30.00	MF395 395GTZ	
			3950.90.03	395 18	
			3951.20.00 3961.30.00	MF395 395GTZ	
			4300.90.78 ⊕	430 18	
			4318.60.00 4351.30.00	MFZ430 430WGTZ	
			4300.90.90 ⊕	430 18	
			4340.60.00 4350.30.00	MFZ430 430WGTZ	

Vehicle list



MERCEDES-BENZ

AXOR 2623 - 2831 09.01 -

2623 L 375.351 2628 B 375.374 2628 K 375.373 2628 L 375.351	01.02 - 10.04	OM 906.920	3950.90.01	395 18	- Equipment Var: SA531129-01
	01.02 - 10.04	OM 906.921	3952.20.00	MF395	
	01.02 - 10.04		3960.30.00	395GTZ	
	01.02 - 10.04		3950.90.03	395 18	- Equipment Var: SA531129-02
			3951.20.00	MF395	
			3961.30.00	395GTZ	
			3950.90.31	395 18	
2628, 2629 950.642, 950.643 2633 950.642, 950.643	10.04 -	OM 902.915 OM 906.921 OM 906.926	3950.90.03	395 18	- Engine code: OM906LA
			3951.20.00	MF395	
			3961.30.00	395GTZ	
	10.04 -	OM 906.995 OM 926.913 OM 926.919 OM 926.945	3950.90.33	395 18	- Engine code: OM906LA
			3951.20.00	MF395	
			3961.30.00	395GTZ	
			8603.47.00	HHIS-3	
			3950.90.38	395 18	- Engine code: OM906LA
			3951.20.00	MF395	
			3961.30.00	395GTZ	
		8653.47.00	HHIS-3		

Vehicle list



MERCEDES-BENZ

AXOR 2623 - 2831 09.01 -

2628 K, 2629 K 952.642, 952.641, 952.643, 374.584 2633 B 953.641, 953.643 2633 K 952.642, 952.641, 952.643 2828 K 958.264 2831 958.260, 958.264	10.04 -	OM 902.915		3620.90.32	362 18	- Engine code: OM904	
			OM 906.921		3606.20.00	MF362	
		10.04 -	OM 906.926		3627.30.00	362WG7B	
		10.04 -	OM 906.930		8603.47.00	HHIS-3	
		10.04 -	OM 926.913		3620.90.42	362 18	- Engine code: OM904
			OM 926.919		3606.20.00	MF362	
			OM 926.926		3627.30.00	362WG7B	
			OM 926.930		8653.47.00	HHIS-3	
		01.11 -	OM 926.932		3950.90.21	395 18	- Engine code: OM904
			OM 926.945		3951.20.00	MF395	- Equipment Var: SA 504672/22
					3971.30.00	395WG7Z	
					3950.90.01	395 18	- Engine code: OM906
					3952.20.00	MF395	
					3960.30.00	395GTZ	
					3950.90.03	395 18	- Engine code: OM906
					3951.20.00	MF395	
					3961.30.00	395GTZ	
					3950.90.31	395 18	- Engine code: OM906
					3952.20.00	MF395	
				3960.30.00	395GTZ		
				8603.47.00	HHIS-3		
				3950.90.33	395 18	- Engine code: OM906	
				3951.20.00	MF395		
				3961.30.00	395GTZ		
				8603.47.00	HHIS-3		
				3950.90.34	395 18	- Engine code: OM906	
				3952.20.00	MF395		
				3960.30.00	395GTZ		
				8653.47.00	HHIS-3		
				3950.90.38	395 18	- Engine code: OM906	
				3951.20.00	MF395		
				3961.30.00	395GTZ		
				8653.47.00	HHIS-3		
				3950.90.36	395 18	- Engine code: OM906	
				3952.20.00	MF395	- Equipment Var: SA 504673/26	
				3960.30.00	395GTZ		
				8604.47.00			
				3950.90.39	395 18	- Engine code: OM906	
				3951.20.00	MF395	- Equipment Var: SA 504673/26	
				3961.30.00	395GTZ		
				8604.47.00			
				3950.90.37	395 18	- Engine code: OM906	
				3952.20.00	MF395		
				3960.30.00	395GTZ		
				8602.47.00			
				3950.90.40	395 18	- Engine code: OM906	
				3951.20.00	MF395		
				3961.30.00	395GTZ		
				8602.47.00			
				3950.90.35	395 18	- Engine code: OM906	
				3952.20.00	MF395		
				3960.30.00	395GTZ		
				8601.47.00			
				3950.90.42	395 18	- Engine code: OM906	
				3951.20.00	MF395		
				3961.30.00	395GTZ		
				8601.47.00			

Vehicle list

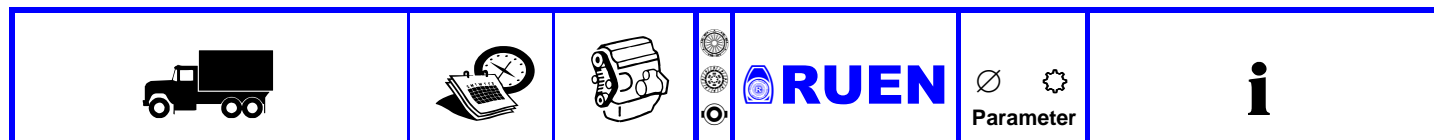

MERCEDES-BENZ

AXOR 2623 - 2831 09.01 -

2635 B 943.141, 943.142, 943.143 2636 2640 2643 2644 S, LS 958.451 2644 S, LS 2831 K	10.05 - 10.04 - 10.04 - 10.04 - 01.11 - 01.11 - 01.01 -	OM 457.918 OM 457.937 OM 457.948 OM 457.956 OM 457.957 OM 457.980 OM 457.981	4300.90.15 ⊕ 4329.60.00 4318.30.00	430 18 MFZ430 430WGTZ	- Equipment Var: SA 531129-04/05
			4300.90.90 ⊕ 4340.60.00 4350.30.00	430 18 MFZ430 430WGTZ	- Equipment Var: SA 504682-24
2636 B 943.142, 943.143 2636 B 943.141 2636 K 942.143, 942.142, 942.141 2636 K 942.141 2640 B 943.141, 943.142, 943.143 2640 K 942.143, 942.142, 942.141 2643 B 943.141, 943.142, 943.143 2643 K 942.143, 942.142, 942.141 2643 K 942.141	10.04 - 01.01 - 10.04 - 10.04 - 10.04 - 10.04 - 10.04 - 10.04 - 10.04 - 01.01 -	OM 457 LA OM 457.937 OM 457.948 OM 457.956 OM 457.957 OM 457.980 OM 457.981	4300.90.15 ⊕ 4329.60.00 4318.30.00	430 18 MFZ430 430WGTZ	
			4000.90.04 4025.10.00 4025.30.00	400 18 MFZ2/400X 400WGTZ	- Vehicles with double disc clutch
2640 S, 2641 S, LS 958.451	10.04 -	OM 457.918	4000.90.17 4022.10.00 4025.30.00	400 18 MFZ2/400X 400WGTZ	

AXOR 3028 - 4144 09.01 -

3028 B 375.374 3028 K 375.373 3228 3228 C 375.381	01.11 - 01.11 - 01.11 - 01.02 - 10.04	OM 906.921	3950.90.01 3952.20.00 3960.30.00	395 18 MF395 395GTZ	- Equipment Var: SA531129-01
			3950.90.03 3951.20.00 3961.30.00	395 18 MF395 395GTZ	- Equipment Var: SA531129-02
			3950.90.31 3952.20.00 3960.30.00 8603.47.00	395 18 MF395 395GTZ HHIS-3	
			3950.90.33 3951.20.00 3961.30.00 8603.47.00	395 18 MF395 395GTZ HHIS-3	
			3950.90.34 3952.20.00 3960.30.00 8653.47.00	395 18 MF395 395GTZ HHIS-3	
			3950.90.38 3951.20.00 3961.30.00 8653.47.00	395 18 MF395 395GTZ HHIS-3	

Vehicle list

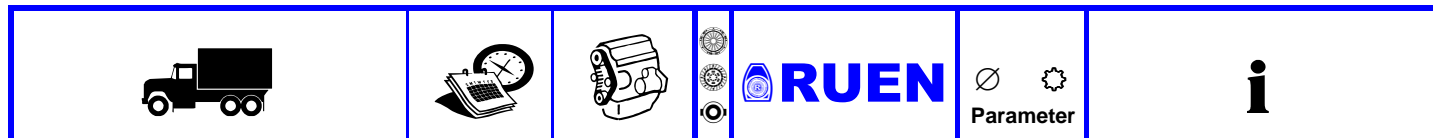

MERCEDES-BENZ

AXOR 3028 - 4144

09.01 -







3131	01.11 -	OM 457.910		4300.90.15 ⊕	430 18	- Equipment Var: SA 531129-04/05
3131 K	01.11 -	OM 457.917		4329.60.00	MFZ430	
3235 940.365	10.04 -	OM 457.918		4318.30.00	430WGTZ	
3335 B 943.163, 943.162	10.04 - 10.05	OM 457.937		4300.90.90 ⊕	430 18	- Equipment Var: SA 504682-24
3335 K 942.162, 942.165, 374.695, 942.163, 942.167	06.09 -	OM 457.948		4340.60.00	MFZ430	
3335 S 944.161	09.08 -	OM 457.956		4350.30.00	430WGTZ	
3340 B 943.163, 943.162	10.04 - 10.05	OM 457.957				
3343 K 958.471, 958.472, 958.478, 942.167	01.11 -	OM 457.962				
3343 S 958.471, 958.472, 958.478	01.11 -					
3344	10.04 -					
3344 K	10.04 -					
3344 S	10.04 -					
3535 K	06.09 -					
4141 K	01.11 -					
4144 K	10.04 -					
4143 K	01.11 -					
3236 B 943.304, 943.305	10.04 -	OM 457.910		4300.90.15 ⊕	430 18	
3236 K 942.304, 942.307, 942.305	10.04 -	OM 457.917		4329.60.00	MFZ430	
3240 940.365	03.05 -	OM 457.918		4318.30.00	430WGTZ	
3240 B 943.304, 943.305	10.04 -	OM 457.937		4000.90.04	400 18	- Vehicles with double disc clutch
3240 K 942.304, 942.307, 942.305	10.04 -	OM 457.948		4025.10.00	MFZ2/400X	
3243 940.365	10.04 -	OM 457.956		4025.30.00	400WGTZ	
3243 B 943.304, 943.305	10.04 -	OM 457.957				
3243 K 942.304, 942.307, 942.305	10.04 -	OM 457.980				
3335 940.163	10.04 -	OM 457.981				
3340, 3341 958.471, 940.163, 958.472, 958.478	10.04 -					
3343 B 943.163, 943.162	10.04 -					
3340 K, 3341 K 958.471, 958.472, 958.478, 942.161, 942.162, 942.165, 942.163, 942.167	10.04 -					
3343 940.163	10.04 -					
4135 B 943.314, 943.317	10.05 -					
4135 K 942.314, 942.317, 942.315	06.09 -					
4140 B 943.314, 943.317	01.11 -					
4140 K 942.314, 942.317, 942.315	06.09 -					
4143 B 943.314, 943.317	01.11 -					
4143 K 942.314, 942.317, 942.315	06.09 -					
3340 S, 3341 S 958.471, 944.161, 958.472, 958.478	06.09 -	OM 457.910		4000.90.17	400 18	
3344 K 958.471, 958.472, 958.478, 942.162	01.11 -	OM 457.917		4022.10.00	MFZ2/400X	
4140 958.471, 958.472, 958.478	01.11 -	OM 457.918		4025.30.00	400WGTZ	
4144 958.471, 958.472, 958.478	01.11 -	OM 457.956				
	01.11 -	OM 457.957				
	01.11 -	OM 457.962				

ECONIC

03.98 -

1823 L, 1823 LL 957.543, 957.541, 957.542, 957.540	03.98 -	OM 906.924		4318.60.00 ⊕	430	
1828 L, 1828 LL 957.543, 957.541, 957.542, 957.540	03.98 -	OM 906.940			MFZ430	
2628 LL 957.654, 957.656, 957.664, 957.666, 957.653, 957.661, 957.657, 957.660, 957.662, 957.663, 6x2/4	03.98 -	OM 906.941				
2628 LL 957.682, 957.681, 6x4	01.98 -	OM 906.951				
		OM 906.952				

Vehicle list

				RUEN	 Parameter	
---	---	---	---	-------------	--	---

MERCEDES-BENZ

ECONIC

03.98 -

<p>1824 L, 1824 LL 957.543, 957.541, 957.542, 957.545, 957.540 1828 L, 1828 LL 957.543, 957.541, 957.542, 957.545, 957.540 1828 LLS 957.582 1829 L, 1829 LL 957.543, 957.541, 957.542, 957.545, 957.540 1833 L, 1833 LL 957.543, 957.541, 957.542, 957.545, 957.540 2628 NGT 957.660 2629 L, 2629 LL 957.654, 957.656, 957.664, 957.653, 957.661, 957.657, 957.660, 957.662, 957.663 2629 L, 2629 LL 957.682, 957.681 2633 L, 2633 LL 957.654, 957.656, 957.664, 957.653, 957.661, 957.657, 957.660, 957.662, 957.663 2633 LL 957.682, 957.681 3233 L, 3233 LL 957.382</p>	<p>10.06 - 10.06 - 10.00 - 10.06 - 10.06 - 10.01 - 10.01 - 10.07 - 10.07 - 10.07 -</p>	<p>M 902.900 M 902.903 OM 902.927 OM 902.933 OM 926 LAG OM 926.924 OM 926.934</p>	<p> 4318.60.00 ⊕</p>	<p>430 MFZ430</p>	
--	--	---	--	------------------------------	--

Vehicle list

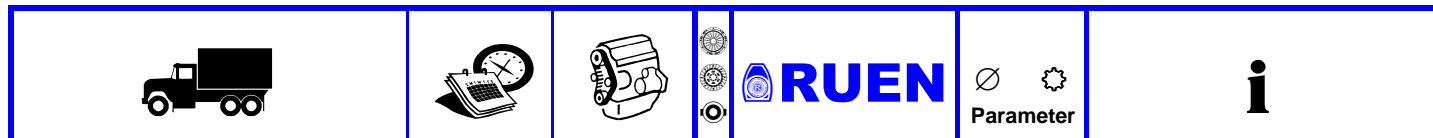

MERCEDES-BENZ

ECONIC

03.98 -

1828 L 957.543	10.00 -	M 902.900	3620.90.32	362 18	- Engine code: OM904
1829 LS 957.582	10.07 -	M 902.903	3606.20.00	MF362	
1828 LS 957.582	10.04 -	M 906.900	3627.30.00	362WG TB	
1833 LS 957.582	10.07 -	OM 902.927	8603.47.00	HHIS-3	
2624 L 957.664, 957.660	03.98 -	OM 902.933	3620.90.42	362 18	- Engine code: OM904
2628 L 957.654, 957.656, 957.664, 957.653, 957.661, 957.657, 957.660, 957.662, 957.663	10.00 -	OM 926.921	3606.20.00	MF362	
2628 L 957.682, 957.681	10.01 -	OM 926.934	3627.30.00	362WG TB	
2628 L 957.654, 957.656, 957.664, 957.653, 957.661, 957.657, 957.662, 957.663	10.02 -		8653.47.00	HHIS-3	
2633 L 957.682, 957.681	10.01 -		3950.90.21	395 18	- Engine code: OM904 - Equipment Var: SA 504672/22
			3951.20.00	MF395	
			3971.30.00	395WG TZ	
			3950.90.01	395 18	- Engine code: OM906
			3952.20.00	MF395	
			3960.30.00	395GTZ	
			3950.90.03	395 18	- Engine code: OM906
			3951.20.00	MF395	
			3961.30.00	395GTZ	
			3950.90.31	395 18	- Engine code: OM906
			3952.20.00	MF395	
			3960.30.00	395GTZ	
			8603.47.00	HHIS-3	
			3950.90.33	395 18	- Engine code: OM906
			3951.20.00	MF395	
			3961.30.00	395GTZ	
			8603.47.00	HHIS-3	
			3950.90.34	395 18	- Engine code: OM906
			3952.20.00	MF395	
			3960.30.00	395GTZ	
			8653.47.00	HHIS-3	
			3950.90.38	395 18	- Engine code: OM906
			3951.20.00	MF395	
			3961.30.00	395GTZ	
			8653.47.00	HHIS-3	
			3950.90.36	395 18	- Engine code: OM906 - Equipment Var: SA 504673/26
			3952.20.00	MF395	
			3960.30.00	395GTZ	
			8604.47.00		
			3950.90.39	395 18	- Engine code: OM906 - Equipment Var: SA 504673/26
			3951.20.00	MF395	
			3961.30.00	395GTZ	
			8604.47.00		
			3950.90.37	395 18	- Engine code: OM906
			3952.20.00	MF395	
			3960.30.00	395GTZ	
			8602.47.00		
			3950.90.40	395 18	- Engine code: OM906
			3951.20.00	MF395	
			3961.30.00	395GTZ	
			8602.47.00		
			3950.90.35	395 18	- Engine code: OM906
			3952.20.00	MF395	
			3960.30.00	395GTZ	
			8601.47.00		
			3950.90.42	395 18	- Engine code: OM906
			3951.20.00	MF395	
			3961.30.00	395GTZ	
			8601.47.00		

Vehicle list



MERCEDES-BENZ

MB / MBO

MB 500 (684.040)			2823.20.00	280 MF280	
			2822.30.00	280 10 280GTZ	
MB 700 (684.043) MBO 700 (684.047/48) MBO 800 / 38 (684.448)			3164.20.00	310 MF310	
			3126.30.00	310 10 310GSBL	
MB 800 T (397.243)			3164.20.00	310 MF310	
MB 800 T/35			3164.20.00	310 MF310	
MB 800 / 32 (684.093) MB 800 / 32ATL (684.083) MB 800 / 38 (684.088) MB 800 / 38 (684.091/098/444) MBO 800 / 38 (684.449) MB 800 / 38ATL (684.081)			3164.20.00	310 MF310	

T1 Box (601) 05.77 - 02.96

210 2.3, 70kW	07.82 - 02.96	M 102.942 M 102.946	2150.90.26	215 10	- To chassis no.: 240087 - Chassis no.: 500001 - 556499 - To chassis no.: 240106 - Chassis no.: 500001 - 556499
			2173.20.00	M215	
			2157.30.00	215PSD	
			3214.40.00	KZI/T - 1	
			2280.90.04	228 10	
			2282.20.00	M228KR	
			2281.30.00	228PSD	
3214.40.00	KZI/T - 1				
210 2.3, 77kW	05.89 - 02.96	M 102.945	2150.90.26	215 10	- To chassis no.: 240087 - Chassis no.: 500001 - 556499 - To chassis no.: 240106 - Chassis no.: 500001 - 556499
			2173.20.00	M215	
			2157.30.00	215PSD	
			3214.40.00	KZI/T - 1	
			2280.90.04	228 10	
			2282.20.00	M228KR	
			2281.30.00	228PSD	
3214.40.00	KZI/T - 1				
210 2.3, 77kW	05.89 - 02.96	M 102.945	2280.90.02	228 10	- Chassis no.: 240088 - 499999 - From chassis no.: 556500 - Chassis no.: 240107 - 499999 - From chassis no.: 556500
			2282.20.00	M228KR	
			2307.30.00	228CB	
			3214.40.00	KZI/T - 1	
210 2.3, 77kW	05.89 - 02.96	M 102.945	2282.20.00	228	- GBox: ZF - For PTO
				M228KR	

Vehicle list

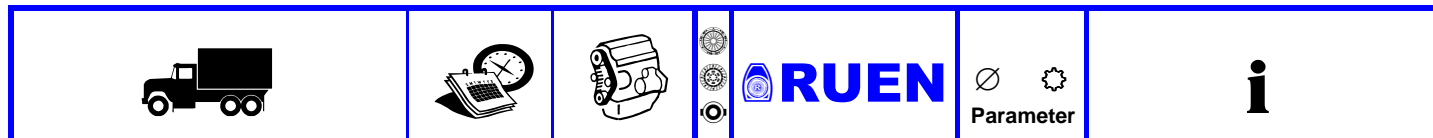

MERCEDES-BENZ

T1 Box (601)		05.77 - 02.96			
207 D 2.4, 53kW	06.82 - 01.90	OM 616.937 OM 616.939	2150.90.26 2173.20.00 2157.30.00 3214.40.00	215 10 M215 215PSD KZI/T - 1	- To chassis no.: 240084 - Chassis no.: 500001 - 556499 - To chassis no.: 240113 - Chassis no.: 500001 - 556499 - Chassis no.: 240085 - 499999 - Chassis no.: 556500 - 941505
			2280.90.02 2282.20.00 2307.30.00 3214.40.00	228 10 M228KR 228CB KZI/T - 1	- To chassis no.: 240084 - Chassis no.: 500001 - 556499 - To chassis no.: 240113 - Chassis no.: 500001 - 556499 - GBox: ZF
			2280.90.03 2283.20.00 2306.30.00 3214.40.00	228 10 M228KR 228GSB KZI/T - 1	- Chassis no.: 240085 - 499999 - To chassis no.: 556500 - Chassis no.: 240114 - 499999 - To chassis no.: 556500 - From chassis no.: 941506
			2281.30.00	228 10 228PSD	- GBox: ZF
208 D 2.3, 58kW	11.88 - 02.96	OM 601.940	2150.90.26 2173.20.00 2157.30.00 3214.40.00	215 10 M215 215PSD KZI/T - 1	- To chassis no.: 240084 - Chassis no.: 500001 - 556499 - To chassis no.: 240113 - Chassis no.: 500001 - 556499 - Chassis no.: 240085 - 499999 - Chassis no.: 556500 - 941505
			2280.90.02 2282.20.00 2307.30.00 3214.40.00	228 10 M228KR 228CB KZI/T - 1	- To chassis no.: 240084 - Chassis no.: 500001 - 556499 - To chassis no.: 240113 - Chassis no.: 500001 - 556499 - GBox: ZF
			2280.90.03 2283.20.00 2306.30.00 3214.40.00	228 10 M228KR 228GSB KZI/T - 1	- Chassis no.: 240085 - 499999 - From chassis no.: 556500 - Chassis no.: 240114 - 499999 - From chassis no.: 556500 - From chassis no.: 941506
			2281.30.00	228 10 228PSD	- GBox: ZF
208 D 2.3, 60kW	10.88 - 02.96	OM 601.940	2150.90.26 2173.20.00 2157.30.00 3214.40.00	215 10 M215 215PSD KZI/T - 1	- To chassis no.: 240084 - Chassis no.: 500001 - 556499 - To chassis no.: 240113 - Chassis no.: 500001 - 556499 - Chassis no.: 240085 - 499999 - Chassis no.: 556500 - 941505
			2280.90.02 2282.20.00 2307.30.00 3214.40.00	228 10 M228KR 228CB KZI/T - 1	- From chassis no.: 240084 - Chassis no.: 500001 - 556499 - From chassis no.: 240113 - Chassis no.: 500001 - 556499 - GBox: ZF
			2280.90.03 2283.20.00 2306.30.00 3214.40.00	228 10 M228KR 228GSB KZI/T - 1	- Chassis no.: 240085 - 499999 - From chassis no.: 556500 - Chassis no.: 240114 - 499999 - From chassis no.: 556500 - From chassis no.: 941506
			2281.30.00	228 10 228PSD	- GBox: ZF
209 D 2.9, 65kW	12.82 - 01.90	OM 617.913	2280.90.03 2283.20.00 2306.30.00 3214.40.00	228 10 M228KR 228GSB KZI/T - 1	
			2283.20.00	228 M228KR	- GBox: ZF - For PTO
			2281.30.00	228 10 228PSD	- GBox: ZF - For PTO
			3214.40.00	KZI/T - 1	- GBox: ZF - For PTO

Vehicle list



MERCEDES-BENZ

T1 Box (601) 05.77 - 02.96

210 D 2.8, 70kW	10.88 - 02.96	OM 602.940	2280.90.03 2283.20.00 2306.30.00 3214.40.00	228 10 M228KR 228GSB KZI/T - 1	
			2281.30.00	228 10 228PSD	- GBox: ZF - For PTO
210 D 2.8, 72kW	10.88 - 02.96	OM 602.940	2280.90.03 2283.20.00 2306.30.00 3214.40.00	228 10 M228KR 228GSB KZI/T - 1	
			2283.20.00	228 M228KR	- GBox: ZF - For PTO
			2281.30.00	228 10 228PSD	- GBox: ZF - For PTO
			3214.40.00	KZI/T - 1	- GBox: ZF - For PTO

T1 Flatbed / Chassis (601) 01.77 - 02.96

210 2.3, 63kW	04.77 - 10.89	M 115.955	2150.90.26 2173.20.00 2157.30.00 3214.40.00	215 10 M215 215PSD KZI/T - 1	- To chassis no.: 240087 - Chassis no.: 500001 - 556499 - To chassis no.: 240106 - Chassis no.: 500001 - 556499
			2280.90.04 2282.20.00 2281.30.00 3214.40.00	228 10 M228KR 228PSD KZI/T - 1	- To chassis no.: 2280.90.04 - Chassis no.: 500001-556499 - To chassis no.: 240106 - Chassis no.: 500001-556499
			2280.90.02 2282.20.00 2307.30.00 3214.40.00	228 10 M228KR 228CB KZI/T - 1	- Chassis no.: 240088-499999 - From chassis no.: 556500 - Chassis no.: 240107-499999 - From chassis no.: 556500
			2283.20.00	228 M228KR	- GBox: ZF - For PTO
210 2.3, 70kW	04.77 - 10.89	M 102.942	2150.90.26 2173.20.00 2157.30.00 3214.40.00	215 10 M215 215PSD KZI/T - 1	- To chassis no.: 240087 - Chassis no.: 500001 - 556499 - To chassis no.: 240106 - Chassis no.: 500001 - 556499
			2280.90.04 2282.20.00 2281.30.00 3214.40.00	228 10 M228KR 228PSD KZI/T - 1	- To chassis no.: 2280.90.04 - Chassis no.: 500001-556499 - To chassis no.: 240106 - Chassis no.: 500001-556499
			2280.90.02 2282.20.00 2307.30.00 3214.40.00	228 10 M228KR 228CB KZI/T - 1	- Chassis no.: 240088-499999 - From chassis no.: 556500 - Chassis no.: 240107-499999 - From chassis no.: 556500
			2283.20.00	228 M228KR	- GBox: ZF - For PTO

Vehicle list



MERCEDES-BENZ

T1 Flatbed / Chassis (601) 01.77 - 02.96

207 D 2.4, 48kW	04.77 - 12.82	OM 616.917	2280.90.02 2282.20.00 2307.30.00 3214.40.00	228 10 M228KR 228CB KZI/T - 1	- To chassis no.: 240084 - Chassis no.: 500001 - 556499 - To chassis no.: 240113 - Chassis no.: 500001 - 556499 - GBox: ZF
			2280.90.03 2283.20.00 2306.30.00 3214.40.00	228 10 M228KR 228GSB KZI/T - 1	- Chassis no.: 240085 - 499999 - From chassis no.: 556500 - Chassis no.: 240114 - 499999 - From chassis no.: 556500 - From chassis no.: 941506
			2150.90.03 2173.20.00 2157.30.00 3203.40.00	215 10 M215 215PSD KZIS - 1	- Chassis no.: 556500 - 941505
			2150.90.26 2173.20.00 2157.30.00 3214.40.00	215 10 M215 215PSD KZI/T - 1	- To chassis no.: 240084 - Chassis no.: 500001 - 556499 - To chassis no.: 240113 - Chassis no.: 500001 - 556499
			2281.30.00	228 10 228PSD	- GBox: ZF
207 D 2.4, 53kW 208 D 2.3, 58kW 208 D 2.3, 60kW	12.77 - 10.89 11.88 - 02.96 06.89 - 02.96	OM 601.940 OM 616.937	2280.90.02 2282.20.00 2307.30.00 3214.40.00	228 10 M228KR 228CB KZI/T - 1	- To chassis no.: 240084 - Chassis no.: 500001 - 556499 - To model year: 240113 - Chassis no.: 500001 - 556499 - GBox: ZF
			2280.90.03 2283.20.00 2306.30.00 3214.40.00	228 10 M228KR 228GSB KZI/T - 1	- Chassis no.: 240085 - 499999 - From chassis no.: 556500 - Chassis no.: 240114 - 499999 - From chassis no.: 556500 - From chassis no.: 941506
			2150.90.03 2173.20.00 2157.30.00 3203.40.00	215 10 M215 215PSD KZIS - 1	- Chassis no.: 240085 - 499999 - Chassis no.: 556500 - 941505 - Chassis no.: 240114 - 499999 - Chassis no.: 556500 - 941505
			2150.90.26 2173.20.00 2157.30.00 3214.40.00	215 10 M215 215PSD KZI/T - 1	- To chassis no.: 240084 - Chassis no.: 500001 - 556499 - To chassis no.: 240113 - Chassis no.: 500001 - 556499
			2281.30.00	228 10 228PSD	- GBox: ZF
209 D 2.9, 65kW 210 D 2.8, 73kW 210 D 2.9, 70kW	12.82 - 01.90 11.88 - 02.96 11.88 - 02.96	OM 602.940 OM 617.913	2280.90.03 2283.20.00 2306.30.00 3214.40.00	228 10 M228KR 228GSB KZI/T - 1	
			2283.20.00	228 M228KR	- GBox: ZF - For PTO
			2281.30.00	228 10 228PSD	- GBox: ZF - For PTO
			3214.40.00	KZI/T - 1	- GBox: ZF - For PTO

Vehicle list



MERCEDES-BENZ

T1 Box (602) 10.82 - 02.96

307 D 2.4	10.82 - 01.90	OM 616.937 OM 616.939	2280.90.02	228 10 M228KR 228CB KZI/T - 1	- To chassis no.: 240084 - Chassis no.: 500001 - 556499 - To chassis no.: 240113 - Chassis no.: 500001 - 556499
			2282.20.00		
			2307.30.00		
			3214.40.00		
			2280.90.03	228 10 M228KR 228GSB KZI/T - 1	- Chassis no.: 240085 - 499999 - From chassis no.: 556500 - Chassis no.: 240114 - 499999 - From chassis no.: 556500
			2283.20.00		
			2306.30.00		
			2283.20.00	228 M228KR	- GBox: ZF - For PTO
			2281.30.00	228 10 228PSD	- GBox: ZF - For PTO
308 D 2.3, 58kW	11.88 - 02.96	OM 601.940	2280.90.02	228 10 M228KR 228CB KZI/T - 1	- To chassis no.: 240084 - Chassis no.: 500001 - 556499 - To chassis no.: 240113 - Chassis no.: 500001 - 556499
			2282.20.00		
			2307.30.00		
			3214.40.00		
			2280.90.03	228 10 M228KR 228GSB KZI/T - 1	- From chassis no.: 556500 - Chassis no.: 240114 - 499999 - From chassis no.: 556500 - Chassis no.: 240114 - 499999
			2283.20.00		
			2306.30.00		
			2283.20.00	228 M228KR	- GBox: ZF - For PTO
			2281.30.00	228 10 228PSD	- GBox: ZF - For PTO
309 D 3.0, 65kW	10.82 - 01.90	OM 617.913	2280.90.03	228 10 M228KR 228GSB KZI/T - 1	
			2283.20.00		
			2306.30.00		
			3214.40.00		
310 D 2.9, 70kW 310 D 2.9, 72kW	06.89 - 02.96 06.89 - 02.96	OM 602.940	2280.90.03	228 10 M228KR 228GSB KZI/T - 1	- From chassis no.: 941506
			2283.20.00		
			2306.30.00		
			3214.40.00		

T1 Flatbed / Chassis (602) 04.77 - 02.96

307 D 2.4, 48kW 307 D 2.4, 53kW	04.77 - 01.83 06.82 - 01.90	OM 616.937 OM 616.939	2280.90.02	228 10 M228KR 228CB KZI/T - 1	- To chassis no.: 240084 - Chassis no.: 500001 - 556499 - To chassis no.: 240113 - Chassis no.: 500001 - 556499
			2282.20.00		
			2307.30.00		
			3214.40.00		
			2280.90.03	228 10 M228KR 228GSB KZI/T - 1	- Chassis no.: 240085 - 499999 - From chassis no.: 556500 - Chassis no.: 240114 - 499999 - From chassis no.: 556500
			2283.20.00		
			2306.30.00		
			2283.20.00	228 M228KR	- GBox: ZF - For PTO
			2281.30.00	228 10 228PSD	- GBox: ZF - For PTO
308 D 2.3, 58kW	06.89 - 02.96	OM 601.940	2280.90.02	228 10 M228KR 228CB KZI/T - 1	- To chassis no.: 240084 - Chassis no.: 500001 - 556499 - To chassis no.: 240113 - Chassis no.: 500001 - 556499
			2282.20.00		
			2307.30.00		
			3214.40.00		
			2280.90.03	228 10 M228KR 228GSB KZI/T - 1	- Chassis no.: 240085 - 499999 - From chassis no.: 556500 - Chassis no.: 240114 - 499999 - From chassis no.: 556500
			2283.20.00		
			2306.30.00		
			2283.20.00	228 M228KR	- GBox: ZF - For PTO
			2281.30.00	228 10 228PSD	- GBox: ZF - For PTO

Vehicle list

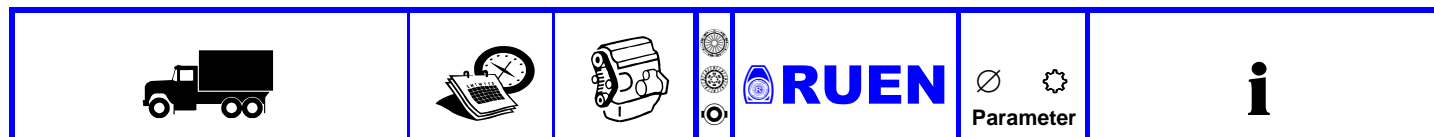

MERCEDES-BENZ

T1 Flatbed / Chassis (602) 04.77 - 02.96

310 D 2.9, 70kW	06.89 - 02.96	OM 602.940		2280.90.03	228 10	
310 D 2.9, 72kW	06.89 - 02.96	OM 617.913		2283.20.00	M228KR	
309 D 3.0, 65kW	10.82 - 01.90			2306.30.00	228GSB	
				3214.40.00	KZI/T - 1	

T2/L Box Body / Estate 01.68 - 12.88

L 613 D (310.510, 313.424, 313.427, 313.429)	04.77 - 12.88	OM 353.963 OM 353.966		2845.20.00	280 HVB280	
				2822.30.00	280 10 280GTZ	
				6901.40.00	KZI - 3	

T2/L Dumptruck 01.68 - 12.88

LK 911 (328.029)	01.71 - 07.83	OM 352.911		2812.20.00	280 HVB280	
LS 911 (328.024, 328.026, 328.044)	01.71 - 07.83			2822.30.00	280 10 280GTZ	
				6909.40.00	KZI - 3	
				2953.20.00	295 GF295	
				2954.30.00	295 10 295BHZ	

T2/L Platform/Chassis 01.68 - 12.88

L 613 D (313.402, 313.404)	04.77 - 12.88	OM 353.963 OM 353.966		2845.20.00	280 HVB280	
				2822.30.00	280 10 280GTZ	- From chassis no.: 346883
				6901.40.00	KZI - 3	
L 911 (328.001, 328.002, 328.003, 328.005, 328.020...)	01.72 - 07.83	OM 352.906 OM 352.911		2812.20.00	280 HVB280	- To chassis no.: 012769
				2822.30.00	280 10 280GTZ	- To chassis no.: 012769
				6909.40.00	KZI - 3	

T2/L Truck Tractor 01.71 - 07.83

L 911 (328.020, 328.022)	01.72 - 07.83	OM 352.911		2812.20.00	280 HVB280	
				2822.30.00	280 10 280GTZ	
				6909.40.00	KZI - 3	
				2953.20.00	295 GF295	
				2954.30.00	295 10 295BHZ	

T2/LN1 Box Body / Estate 04.86 - 12.94

609 D (668.061, 668.062, 668.063)	04.86 - 12.94	OM 364.906		2800.90.01	280 10	- Engine code: OM364
	04.86 - 12.94	OM 364.911		2837.20.00	MFZ280	
709 D (669.061, 669.062, 669.063)	04.86 - 12.94	OM 364.912		2822.30.00	280GTZ	
	04.86 - 12.94	OM 364.919		5700.40.00	KZIZ - 3	
	04.86 - 12.94	OM 364.920				
809 D (670.061, 670.062, 670.063)	04.86 - 12.94	OM 364.921				
	04.86 - 12.94					
711 D (669.361, 669.362, 669.363)	04.86 - 12.94	OM 354.902		3100.90.02	310 10	- Engine code: OM364A
	04.86 - 12.94	OM 354.903		3176.20.00	MFZ310	
714 D (669.361, 669.362, 669.363)	06.94 - 12.94	OM 354.923		3126.30.00	310GSBL	
		OM 364.950		5700.40.00	KZIZ - 3	
		OM 364.952				
		OM 364.957		3136.30.00	310 10 310WGSZ	- Engine code: OM364A

Vehicle list



MERCEDES-BENZ

T2/LN1 Box Body / Estate 04.86 - 12.94

811 D (670.362, 670.363)	04.86 - 12.94 04.86 - 12.94	OM 354.901 OM 354.903 OM 364.950 OM 364.952 OM 364.958	 	3100.90.02 3176.20.00 3126.30.00 5700.40.00	310 10 MFZ310 310GSBL KZIZ - 3	- Engine code: OM364A
814 D (670.364, 670.365, 670.366)	11.87 - 12.94 11.87 - 12.94	OM 354.924 OM 364.981 OM 364.986	 	3176.20.00	310 MFZ310	- Engine code: OM364LA
				3126.30.00	310 10 310GSBL	- Engine code: OM364LA
				5700.40.00	KZIZ - 3	- Engine code: OM364LA
814 DA 4x4 (670.464, 670.465)	11.87 - 12.94 11.87 - 12.94	OM 354.925 OM 364.984 OM 364.987	 	3176.20.00	310 MFZ310	- Engine code: OM364LA
				3126.30.00	310 10 310GSBL	- Engine code: OM364LA
				5700.40.00	KZIZ - 3	- Engine code: OM364LA
				3136.30.00	310 10 310WGSZ	- Engine code: OM364LA
609 D (668.061, 668.062, 668.063)	06.94 - 12.94	OM 354.902		2800.90.01 2837.20.00 2822.30.00 5700.40.00	280 10 MFZ280 280GTZ KZIZ - 3	

T2/LN1 Dumptruck 04.86 - 12.94

609 DK (668.041, 668.042)	04.86 - 12.94 04.86 - 12.94	OM 364.906 OM 364.911	 	2800.90.01 2837.20.00 2822.30.00 5700.40.00	280 10 MFZ280 280GTZ KZIZ - 3	- Engine code: OM364
709 DK (669.041, 669.042)	04.86 - 12.94	OM 364.919 OM 364.920				
809 DK (670.041, 670.042)	04.86 - 12.94 04.86 - 12.94	OM 364.921				
811 DK (670.341, 670.342)	04.86 - 12.94 04.86 - 12.94	OM 354.901 OM 354.903 OM 364.950 OM 364.952 OM 364.958	 	3100.90.02	310 10 MFZ310 310GSBL KZIZ - 3	- Engine code: OM364A
				3176.20.00		
				3126.30.00		
				5700.40.00		

T2/LN1 Platform/Chassis 04.86 - 12.94

609 D (668.001, 668.002, 668.003)	04.86 - 12.94 04.86 - 12.94	OM 364.906 OM 364.911	 	2800.90.01 2837.20.00 2822.30.00 5700.40.00	280 10 MFZ280 280GTZ KZIZ - 3	- Engine code: OM364
709 D (669.001, 669.002, 669.003, 669.041, 669.000)	04.86 - 12.94	OM 364.912 OM 364.919				
709 D (669.000, 669.001, 669.002, 669.003, 669.041)	04.86 - 12.94	OM 364.920 OM 364.921				
809 D (670.001, 670.002, 670.003)	04.86 - 12.94 04.86 - 12.94					
711 D (669.301, 669.302, 669.303)	04.86 - 12.94 04.86 - 12.94	OM 354.902 OM 354.903	 	3100.90.02 3176.20.00 3126.30.00 5700.40.00	310 10 MFZ310 310GSBL KZIZ - 3	- Engine code: OM364A
714 D (669.301, 669.302, 669.303)	06.94 - 12.94	OM 354.923				
814 D (670.312, 670.313)	11.87 - 12.94	OM 354.924	 	3136.30.00	310 10 310WGSZ	- Engine code: OM364A
814 DA 4x4 (670.411, 670.412)	11.87 - 12.94	OM 354.925				
814 D (670.312, 670.313)	11.87 - 12.94	OM 364.950				
814 DA 4x4 (670.411, 670.412)	11.87 - 12.94	OM 364.952				
		OM 364.957 OM 364.981 OM 364.984 OM 364.986 OM 364.987				

Vehicle list

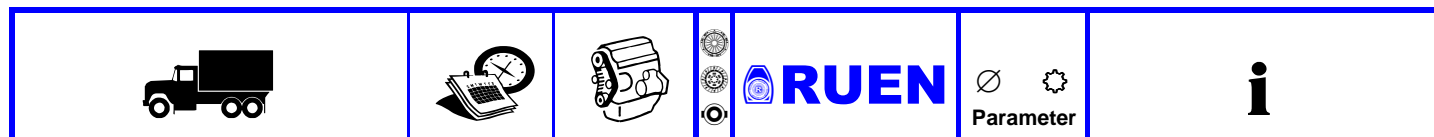

MERCEDES-BENZ

T2/LN1 Platform/Chassis 04.86 - 12.94

811 D (670.302, 670.303)	04.86 - 12.94 04.86 - 12.94	OM 354.901 OM 354.903 OM 364.950 OM 364.952 OM 364.958	3100.90.02 3176.20.00 3126.30.00 5700.40.00	310 10 MFZ310 310GSBL KZIZ - 3	- Engine code: OM364A
609 D (668.001, 668.002, 668.003)	06.94 - 12.94	OM 354.902	2800.90.01 2837.20.00 2822.30.00 5700.40.00	280 10 MFZ280 280GTZ KZIZ - 3	

T2/LN1 Cab with engine 04.86 - 12.94

809 DT (670.199)	04.86 - 12.94 04.86 - 12.94	OM 364.911	2800.90.01 2837.20.00 2822.30.00 5700.40.00	280 10 MFZ280 280GTZ KZIZ - 3	- Engine code: OM364
------------------	--------------------------------	------------	---	---	----------------------

Unimog 20-100

U 40 421.123, 421.122 U 45 421.123, 421.122	01.66 - 04.71 01.66 - 04.71	OM 615.911 OM 621.931	2530.20.00	250 G250	
			2538.30.00	250 10 250TPZ	
U 52 421.122-163 U 60,T 421.122-163			2530.20.00	250 G250	
			2538.30.00	250 10 250TPZ	
U 54 403.120, 403.121	04.66 - 03.72	OM 314.916	2808.20.00	280 G280	- To chassis no.: 088736
			2805.30.00	280 10 280BHZ	- To chassis no.: 088736
			3161.20.00	310 MF310	- From chassis no.: 088737
			3117.30.00	310 10 310GSZ	- From chassis no.: 088737
U 55,T 421.131, 421.130			2530.20.00	250 G250	
			2538.30.00	250 10 250TPZ	
U 65 T, U 70 T 406.131, 406.130 U 65, U 70 406.120, 406.121, 4580cc U 65, U 70 406.120, 406.121, 5675cc U 66, U 72 403.122, 403.123 U 72, U 80 413.111, 413.110 U 80 T, U 90 T 406.133, 416.133, 416.130	01.62 - 01.88	OM 312.954	2808.20.00	280 G280	- To chassis no.: 088736
	01.62 - 01.88	OM 314.917	2805.30.00	280 10 280BHZ	- To chassis no.: 088736
	01.62 - 01.88	OM 352.903	3161.20.00	310 MF310	- From chassis no.: 088737
	03.69 - 01.88	OM 352.919	3117.30.00	310 10 310GSZ	- From chassis no.: 088737
U 80, U 84, U 90 416.123, 416.122, 416.125, 416.127, 406.121, 416.124, 416.126	05.69 - 01.88	OM 352.903 OM 353.902	2841.20.00	280 G280	- To chassis no.: 088736 - To chassis no.: 003772
			2808.20.00	280 G280	- To chassis no.: 088736
			2805.30.00	280 10 280BHZ	- To chassis no.: 088736 - To chassis no.: 003772
			3161.20.00	310 MF310	- From chassis no.: 088737
			3117.30.00	310 10 310GSZ	- From chassis no.: 088737 - Chassis no.: 003773 - 088736
			3125.20.00	310 GFX310	- Chassis no.: 003773 - 088736
U 84 406.145, 406.142, 406.143			3125.20.00	310 GFX310	- Chassis no.: 003773 - 088736
			3117.30.00	310 10 310GSZ	- Chassis no.: 003773 - 088736

Vehicle list



MERCEDES-BENZ

Unimog 20-100

U 20 405.050	09.06 - 09.06 - 09.06 -	OM 900.915	3620.90.02	362 18	
			3606.20.00 3627.30.00	MF362 362WGTB	
			3620.90.42	362 18	
			3606.20.00 3627.30.00 8653.47.00	MF362 362WGTB HHIS-3	

Unimog 100-500

411 S	01.52 - 01.54 -		2262.20.00	225	
			2260.30.00	225 10	
U 100,L,T 416.122-163 U 110,L,T 416.122-163 U 110,L,T 416.114-117, 416.134, 416.122-125, 416.140-163, 416.160, 416.130-135, 416.135 U 125 416.122-163			3161.20.00	310	- From chassis no.: 088737
			3117.30.00	310 10	
U 100,L,T 416.114-117, 416.134, 416.122-125, 416.140-163, 416.160, 416.130-135, 416.135			2808.20.00	280	
			2805.30.00	280 10	- From model year: 088736
			3125.20.00	310	- To chassis no.: 088736
			3117.30.00	310 10	- To chassis no.: 088736
U 110,U 110L 418.100, 418.115	02.92 -	OM 364.955 OM 364.958	3300.20.00	330	
U 125 416.114-117, 416.134, 416.140-163, 416.135			3125.20.00	310	- To chassis no.: 088736
			3117.30.00	310 10	- To chassis no.: 088736
U 130,U 140 418.102 U 140L 418.237, 418.217, 418.117 U 140T 418.000	07.92 - 07.92 - 07.92 -	OM 364.982 OM 364.985	3300.20.00	330	- Vehicles with single clutch disc
				GFM330	
U 300 405.101, 405.100, 110kW U 300 405.121, 405.120, 130kW U 400 405.103, 405.102, 130kW	03.00 - 03.00 - 03.00 -	OM 904.927 OM 904.928	3606.20.00	362	
			3620.90.02	362 18	- Vehicles with single clutch disc
			3606.20.00 3627.30.00 3620.90.42	MF362 362WGTB HHIS-3	- Vehicles with single clutch disc
U S 404 404.115, 404.114, 404.113, 60 - 67kW	01.55 - 12.76	M 180.952 M 180.953	2262.20.00	225	
			2260.30.00	225 10	
U 110,L,T 416.141, 416.140 U S 404 404.117, 33kW	01.68 -	OM 615.911	2530.20.00	250	
			2538.30.00	250 10	
U 400 405.123, 405.122, 170kW U 500, UGN NA 405.221, 405.230, 405.200, 405.201, 405.210 U 500, UGN NA 405.221, 405.220, 405.230, 405.201, 405.210, 205 - 209kW	03.00 - 10.00 - 10.00 -	OM 906.935 OM 906.955 OM 906.967	3951.20.00	395	
			3606.30.00	362 18	
				MF395	
				362WGTB	

Vehicle list

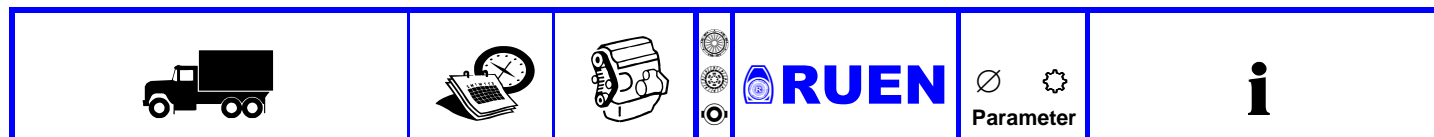

MERCEDES-BENZ

Unimog 100-500

U 216 405.090 U 218 405.090 U 318 405.104 U 423 405.105 U 423 L 405.125	05.13 - 05.13 - 05.13 - 05.13 - 05.13 -			3951.20.00	395 MF395	- Engine code: OM 934
				8653.47.00	HHIS-3	- Engine code: OM 934
U 427, U 427 L 405.110, 405.125 U 430, U 430 L 405.110, 405.125	05.13 - 05.13 -			3951.20.00	395 MF395	- Engine code: OM 934/936
				8653.47.00	HHIS-3	- Engine code: OM 934/936
UX 100H,UX 100M 409.100	09.96 -	OM 602.981 OM 602.989		2548.30.00	250 26 250CD	

Unimog 500-900

U 52, U 60, U 600,U 600L 421.128, 421.141, 421.140, 421.162, 421.129, 421.163 U 60T, U 600T 421.133, 421.132 U 600 407.200, 4.50t U 600 407.100, 5.80t U 650,U 650L 407.210, 407.211, 4.50t U 650,U 650L 407.111, 407.110, 5.80t	01.77 - 05.88 01.77 - 05.88 05.88 - 05.88 - 05.88 - 05.88 -	OM 616.911 OM 616.915 OM 616.931 OM 616.932 OM 616.942 OM 616.943		2530.20.00	250 G250	
				2538.30.00	250 10 250TPZ	
U 800 403.122, 417.200, 53 - 55kW, 6t U 800L 413.111, 413.110	01.77 - 03.90 01.77 - 03.90	OM 314.917		2808.20.00	280 G280	- To chassis no.: 088736
				2805.30.00	280 10 280BHZ	- To chassis no.: 088736
				3161.20.00	310 MF310	- From chassis no.: 088737
				3117.30.00	310 10 310GSZ	- From chassis no.: 088737
U 800 417.100, 53 - 55kW, 7.50t	05.88 - 03.90	OM 314.917		3161.20.00	310 MF310	
				3117.30.00	310 10 310GSZ	
U 900				3125.20.00	310 GFX310	
				3117.30.00	310 10 310GSZ	
U 900 406.120, 417.201, 406.121, 417.101, 62kW, 6t	01.77 -	OM 353.902		2808.20.00	280 G280	- To chassis no.: 088736
				2805.30.00	280 10 280BHZ	- To chassis no.: 088736
				3161.20.00	310 MF310	- From chassis no.: 088737
				3117.30.00	310 10 310GSZ	- From chassis no.: 088737
U 900 417.101, 62kW, 7.50t U 900 417.106, 81kW, 7.50t	05.88 - 11.88 -	OM 353.902 OM 356.912 OM 366.939		3161.20.00	310 MF310	
				3117.30.00	310 10 310GSZ	
U 900 406.142, 406.143, 81kW, 6t	01.77 - 01.88	OM 353.940		3125.20.00	310 GFX310	
				3117.30.00	310 10 310GSZ	
U 527, U 527 L 405.222, 405.202 U 530, U 530 L 405.222, 405.202	05.13 - 05.13 -			3951.20.00	395 MF395	- Engine code: OM 936
				8653.47.00	HHIS-3	- Engine code: OM 936
U 900 406.145				3125.20.00	310 GFX310	- From chassis no.: 003773 - To chassis no.: 088736
				3117.30.00	310 10 310GSZ	- From chassis no.: 003773 - To chassis no.: 088736

Vehicle list



MERCEDES-BENZ

Unimog 1000-1350







U 1000 424.121, 70kW	01.77 - 05.88	OM 353.940		3161.20.00	310 MF310	- From chassis no.: 088737
U 1000 427.100, 75kW	01.88 -	OM 353.962				
U 1000T 424.131	01.77 - 12.82	OM 353.980 OM 356.914		8302.40.00	KZI - 4	
U 100, U 110, U 1100L 416.115, 416.141, 416.160, 416.140, 416.116, 416.117	01.77 - 05.88	OM 353.901 OM 353.940 OM 353.980		2520.20.00	250 G250	- From chassis no.: 088737
				2518.30.00	250 10 250GSZ	
				3125.20.00	310 GFX310	- To chassis no.: 088736
				3117.30.00	310 10 310GSZ	- To chassis no.: 088736 - From chassis no.: 088737
				3161.20.00	310 MF310	- From chassis no.: 088737
U 125, U 1100L 416.114, 416.163, 416.162	01.77 - 01.88	OM 353.907		3125.20.00	310 GFX310	- To chassis no.: 088736
				3117.30.00	310 10 310GSZ	- To chassis no.: 088736 - From chassis no.: 088737
				3161.20.00	310 MF310	- From chassis no.: 088737
U 100, U 110T, U 1100T 416.134, 417.000, 416.135	01.77 -	OM 353.901 OM 353.940 OM 353.980		3161.20.00	310 MF310	- To chassis no.: 088736
				3117.30.00	310 10 310GSZ	
				2808.20.00	280 G280	- To chassis no.: 088736
				2805.30.00	280 10 280BHZ	- To chassis no.: 088736
U 1150,U 1150L 417.220, 417.210, 417.211, 6t	05.88 -	OM 353.907 OM 353.940		3161.20.00	310 MF310	- Vehicles with single clutch disc
				3117.30.00	310 10 310GSZ	- Vehicles with single clutch disc
U 1150,U 1150L 417.110, 417.116, 417.111, 417.115, 417.120, 7.50t	05.88 -	OM 353.901 OM 353.940 OM 353.980				
U 1150L 417.212	05.88 -	OM 353.901 OM 353.940 OM 353.980				
U 1200 427.101, 8.50t	01.88 -	OM 353.973 OM 353.995 OM 356.950 OM 356.954 OM 366.949 OM 366.955		3300.20.00	330 GFM330	
				3310.30.00	330 20 330GSZ	
				8302.40.00	KZI - 4	
U 1200 424.122, 7.50t	02.82 - 05.88	OM 353.973 OM 353.995		3300.20.00	330 GFM330	- To chassis no.: 001570 - From chassis no.: 001571
				3321.30.00	330 20 330GSB	- To chassis no.: 001570
				3310.30.00	330 20 330GSZ	- From chassis no.: 001571
				8302.40.00	KZI - 4	- To chassis no.: 001570 - From chassis no.: 001571
U 1200T 427.000, 13.75t	01.88 -	OM 356.950				
U 1200T 424.132, 12.75t	01.83 - 05.88	OM 356.954				
U 1250 424.127, 424.126	12.84 - 05.88	OM 366.949				
U 1250,U 1250L 427.110, 427.111	01.88 -	OM 366.955				
U 1250L 427.111	01.88 -	OM 366.955				
U 1300,L 435.131, 435.141, 435.113, 435.117, 435.120, 435.121, 435.110	01.88 -	OM 366.955				
U 1300,L 425.121, 425.110, 425.120, 425.131, 425.141	01.88 -	OM 366.955				
U 1300 425.121	01.77 - 12.84	OM 353.973 OM 353.995		3300.20.00	330 GFM330	- To chassis no.: 001570 - From chassis no.: 001571
				3321.30.00	330 20 330GSB	- To chassis no.: 001570
				3310.30.00	330 20 330GSZ	- From chassis no.: 001571
				8302.40.00	KZI - 4	- To chassis no.: 001570 - From chassis no.: 001571
U 1300L 436.325, 436.326	01.77 - 05.88	OM 382.917		3563.20.00	350 GMF350	
				8302.40.00	KZI - 4	

Vehicle list

















					
---	---	---	--	---	---

MERCEDES-BENZ

Unimog 1000-1350

U 1300,U 1300L 425.121, 435.117, 436.320, 435.115, 436.321	01.77 - 05.88	OM 353.961 OM 353.973	 3300.20.00	330 GFM330	- To chassis no.: 001570 - From chassis no.: 001571 - To chassis no.: 002154 - From chassis no.: 002155
			 3321.30.00	330 20 330GSB	- To chassis no.: 001570 - To chassis no.: 002154
			 3310.30.00	330 20 330GSZ	- From chassis no.: 001571 - From chassis no.: 002155
			 8302.40.00	KZI - 4	- To chassis no.: 001570 - From chassis no.: 001571 - To chassis no.: 002154 - From chassis no.: 002155
U 1350L 437.110	05.88 -	OM 366.955	 3300.20.00	330 GFM330	
			 3310.30.00	330 20 330GSZ	
			 8302.40.00	KZI - 4	- From chassis no.: 173809

Unimog 1400-1750

U 1400 424.127, 424.132, 424.122, 424.126 U 1450 424.127, 424.132, 424.122, 424.126 U 1500 435.131, 435.141, 435.113, 435.117, 435.120, 435.121, 435.110 U 1700,U 1700L			 3300.20.00	330 GFM330	
			 3310.30.00	330 20 330GSZ	
			 8302.40.00	KZI - 4	
U 1400 427.102, 100kW U 1450,U 1450L 427.112, 427.111	01.88 - 01.88 -	OM 357.912 OM 366.947 OM 366.948 OM 366.955 OM 366.956	 3300.20.00	330 GFM330	
			 3310.30.00	330 20 330GSZ	
			 8302.40.00	KZI - 4	
U 1500 425.141, 110kW U 1500T 425.131 U 1550 424.126 U 1550L 424.127, 92 - 96kW	01.77 - 05.88 01.77 - 05.88 01.86 - 05.88 02.86 - 05.88	OM 353.958 OM 353.961 OM 353.995	 3300.20.00	330 GFM330	- Vehicles with single clutch disc
			 3310.30.00	330 20 330GSZ	- Vehicles with single clutch disc
			 8302.40.00	KZI - 4	- Vehicles with single clutch disc
U 1550L 437.111, 437.120, 100kW U 1550L 437.123, 437.120, 437.141, 437.125, 114kW U 1550L 437.111, 115kW U 1550L 437.123, 437.111, 437.120, 125kW	05.88 - 01.92 - 05.88 - 01.92 -	OM 356.955 OM 356.956 OM 366.955 OM 366.956 OM 366.963	 3563.20.00	350 GMF350	- To chassis no.: 173809
			 3566.20.00	350 GMF350	- From chassis no.: 173810
			 8302.40.00	KZI - 4	- To chassis no.: 173809
U 1550L 437.116, 437.125, 150 - 157kW U 1550L 437.116, 437.125, 177kW U 1600 427.107, 150 - 157kW U 1600 427.107, 177kW	05.88 - 05.88 - 09.89 - 05.91 -	OM 356.980 OM 356.997 OM 357.924 OM 357.945 OM 366.984	 3566.20.00	350 GMF350	- To chassis no.: 173809 - From chassis no.: 173810
			 8302.40.00	KZI - 4	- To chassis no.: 173809
U 1600 427.105, 115kW U 1650,U 1650L 427.118, 427.117, 150 - 157kW U 1650,U 1650L 427.118, 427.117, 177kW U 1700T 437.000 U 1750,U 1750L 437.112, 437.113, 12t U 1750,U 1750L 437.130, 437.131, 12.50t	01.88 - 09.89 - 05.91 - 09.88 - 09.88 - 09.88 -	OM 356.956 OM 356.957 OM 356.980 OM 356.981 OM 356.997 OM 357.924 OM 357.945 OM 366.949 OM 366.963 OM 366.984	 3563.20.00	350 GMF350	- To chassis no.: 173809
			 3566.20.00	350 GMF350	- From chassis no.: 173810
			 8302.40.00	KZI - 4	- To chassis no.: 173809

Vehicle list



MERCEDES-BENZ

Unimog 1400-1750

U 1650, U 1650L 427.115, 427.116, 115kW	01.88 -	OM 356.956 OM 366.948 OM 366.949	3563.20.00	350 GMF350	- To chassis no.: 173809
			3566.20.00	350 GMF350	- From chassis no.: 173810
			8302.40.00	KZI - 4	- To chassis no.: 173809
			3310.30.00	330 20 330GSZ	- Special design
U 1700, U 1700 L 436.340, 436.341, 437.100, 436.342, 436.343, 122 - 125kW	09.88 -	OM 356.957 OM 366.963 OM 382.950	3563.20.00	350 GMF350	- To chassis no.: 17309
			3566.20.00	350 GMF350	- From chassis no.: 173810
			8302.40.00	KZI - 4	- To chassis no.: 173809
U 1700, U 1700L U 1700L 435.113	05.78 - 09.88	OM 353.959	3300.20.00	330 GMF330	
			3310.30.00	330 20 330GSZ	
			8302.40.00	KZI - 4	
U 1700, U 1700L 435.110, 435.111, 124kW	05.78 - 09.88	OM 353.959	3300.20.00	330 GMF330	- To chassis no.: 002154 - From chassis no.: 002155
			3321.30.00	330 20 330GSB	- To chassis no.: 002154
			3310.30.00	330 20 330GSZ	- From chassis no.: 002155
			8302.40.00	KZI - 4	

Unimog 1800-2050

U 1800, T			3563.20.00	350 GMF350	- To chassis no.: 173809
			3566.20.00	350 GMF350	- From chassis no.: 173810
			8302.40.00	KZI - 4	- To chassis no.: 173809
U 1800, T U 1850 L/38 437.133 U 1850, L 437.114, 437.115			3566.20.00	350 GMF350	
			8302.40.00	KZI - 4	- To chassis no.: 173809
U 1800 437.102 U 1800T 437.002 U 1850, U 1850L 437.114, 437.115, 437.133	04.92 - 04.92 - 04.92 -	OM 356.998	8302.40.00	KZI - 4	- To chassis no.: 173809

Unimog 2100-2450

U 2100 437.105 U 2100T 437.002 U 2150 437.135 U 2150, U 2150L 437.170, 437.118, 437.171, 437.136, 437.117, 155 - 157kW U 2150, U 2150L 437.118, 437.136, 437.117, 177kW U 2400 437.105 U 2450, U 2450L 437.118, 437.136, 437.117	09.89 - 09.89 - 09.89 - 09.89 - 09.89 - 05.91 - 05.91 -	OM 356.980 OM 356.997 OM 357.924 OM 357.945 OM 366.984	3566.20.00	350 GMF350	
			8302.40.00	KZI - 4	- To chassis no.: 173809
U 2400TG 437.182 U 2450L 437.156	07.93 - 07.93 -	OM 356.980 OM 357.945	3566.20.00	350 GMF350	

Vehicle list

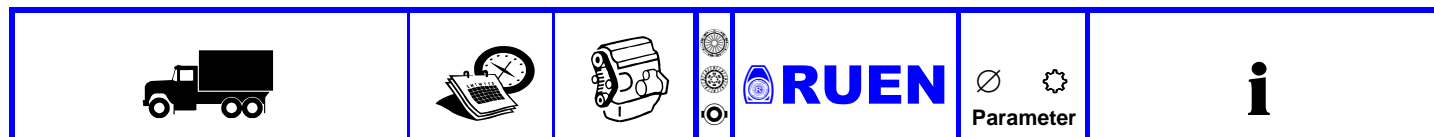

MERCEDES-BENZ

Unimog 2500-5000

U 3000 437.425, 437.426, 437.420, 437.421 U 3000 437.425, 437.420	09.02 -	OM 900.920		3951.20.00	395 MF395	
		OM 904.952		3606.20.00	362 MF362	
	09.02 -	OM 904.953		3606.30.00	362 18 362WGTB	
				3627.30.00	362 18 362WGTB	
				8653.47.00	HHIS-3	
U 5000 437.435, 437.431, 437.436, 437.460, 437.430, 437.465	09.02 -	OM 924.916		3606.20.00	362 MF362	
		OM 924.923		3951.20.00	395 MF395	
				3627.30.00	362 18 362WGTB	- Engine code: OM924.916
				8653.47.00	HHIS-3	- Engine code: OM924.916
U 4000 436.330, 115kW U 4000 437.425, 437.426, 437.420, 437.421, 110kW U 4000 437.425, 437.426, 437.420, 436.330, 437.421, 130kW	01.02 -	OM 900.920		3606.20.00	362 MF362	
	09.02 -	OM 904 LA		3606.30.00	362 18 362WGTB	
	09.02 -	OM 904.952		3627.30.00	362 18 362WGTB	
	09.02 -	OM 904.953		8653.47.00	HHIS-3	
U 4000 437.425, 437.426, 437.420, 437.421, 160kW	09.02 -	OM 924.916		3606.20.00	362 MF362	- Engine code: OM 904 LA
		OM 924.923		8653.47.00	HHIS-3	- Engine code: OM 904 LA
U 4023 437.427	05.13 -	OM 934.974		3620.90.02	362 18 MF362	
				3606.20.00	362WGTB	
				3627.30.00		
				3620.90.42	362 18 MF362	
				3606.20.00	362WGTB	
				3627.30.00	HHIS-3	
				8653.47.00		

ZETROS 09.08 -

1833 A 949.016	09.08 -	OM 926.935		3972.20.00	395 MF395	
2733 A 949.066	09.08 -	OM 926.936				
		OM 926.947				

VARIO Box Body / Estate 09.96 -

613 D, 614 D (668.351, 668.352, 668.353)	09.96 -	OM 900.917		3620.90.02	362 18 MF362	- Engine code: OM904LA
	09.96 -	OM 900.918		3606.20.00	362WGTB	
615 D, 616 D (668.351, 668.352, 668.353)	09.98 -	OM 904.908		3627.30.00	362 MF362	- Engine code: OM904LA
	09.98 -	OM 904.923		3606.20.00	362 18 362WGTB	- Engine code: OM904LA
				8540.40.00	KZIS-4	- Engine code: OM904LA
812 D (670.351, 670.352, 670.353)	09.96 -	OM 602.984		3620.90.02	362 18 MF362	- Engine code: OM904LA
	09.96 -	OM 602.985		3606.20.00	362WGTB	
813 D, 814 D (670.351, 670.352, 670.353)	09.96 -	OM 900.917		3627.30.00		
	09.96 -	OM 900.918		3606.20.00	362 MF362	- Engine code: OM904LA
815 D, 816 D (670.351, 670.352, 670.353)	09.96 -	OM 904.908		8540.40.00	KZIS-4	- Engine code: OM904LA
	09.96 -	OM 904.923		3627.30.00	362 18 362WGTB	- Engine code: OM904LA

Vehicle list

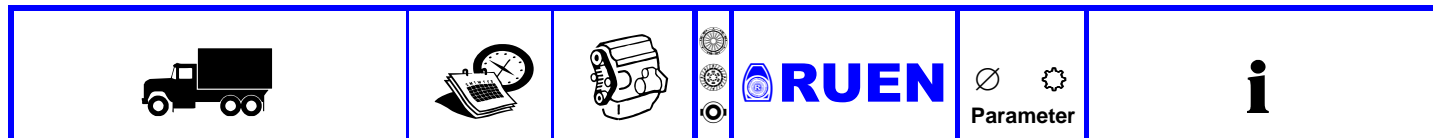

MERCEDES-BENZ

VARIO Box Body / Estate

09.96 -

813 DA, 814 DA 4x4 (669.599, 670.451, 670.452, 670.453)	09.96 -	OM 904.908	3620.90.02	362 18	- Engine code: OM904LA
	09.96 -	OM 904.923	3606.20.00 3627.30.00	MF362 362WGTTB	
815 DA, 816 DA 4x4 (669.599, 670.451, 670.452, 670.453)	09.96 -		3606.20.00	362	- Engine code: OM904LA
	09.96 -		3627.30.00	362 18	- Engine code: OM904LA
	09.96 -		8540.40.00	KZIS-4	- Engine code: OM904LA

VARIO Dumptruck

09.96 -

613 D, 614 D (668.331, 668.332)	09.96 -	OM 900.917	3620.90.02	362 18	- Engine code: OM904LA
	09.96 -	OM 900.918	3606.20.00 3627.30.00	MF362 362WGTTB	
615 D, 616 D (668.331, 668.332)	09.98 -	OM 904.908	3606.20.00	362	- Engine code: OM904LA
	09.98 -	OM 904.923	3627.30.00	362 18	- Engine code: OM904LA
813 DA, 814 DA 4x4 (670.431, 670.432)	09.96 -		8540.40.00	KZIS-4	- Engine code: OM904LA
	09.96 -				
815 DA, 816 DA 4x4 (670.431, 670.432)	09.96 -				
	09.96 -				
812 D (670.331, 670.332)	09.96 -	OM 602.984	3620.90.02	362 18	- Engine code: OM904LA
	09.96 -	OM 602.985	3606.20.00 3627.30.00	MF362 362WGTTB	
813 D, 814 D (670.331, 670.332)	09.96 -	OM 900.917	3606.20.00	362	- Engine code: OM904LA
	09.96 -	OM 904.908	3627.30.00	362 18	- Engine code: OM904LA
815 D, 816 D (670.331, 670.332)	09.96 -	OM 904.923	8540.40.00	KZIS-4	- Engine code: OM904LA
	09.96 -				

VARIO Platform/Chassis

09.96 -

613 D, 614 D (668.321, 668.322, 668.323)	09.96 -	OM 900.918	3620.90.02	362 18	- Engine code: OM904LA
	09.96 -	OM 900.919	3606.20.00 3627.30.00	MF362 362WGTTB	
615 D, 616 D (668.321, 668.322, 668.323)	09.98 -	OM 904.908	3606.20.00	362	- Engine code: OM904LA
	09.98 -	OM 904.923	3627.30.00	362 18	- Engine code: OM904LA
618 D (668.321, 668.322, 668.323)	09.06 -	OM 904.964	8540.40.00	KZIS-4	- Engine code: OM904LA
	09.06 -				
813 DA, 814 DA 4x4 (670.421, 670.422, 670.423)	09.96 -				
	09.96 -				
815 DA, 816 DA 4x4 (670.421, 670.422, 670.423)	09.96 -				
	09.96 -				
818 D (670.321, 670.322, 670.323, 670.324)	09.06 -				
	09.06 -				
818 DA 4x4	09.06 -				
	09.06 -				
812 D (670.321, 670.322, 670.323, 670.324)	09.96 -	OM 602.984	3620.90.02	362 18	- Engine code: OM904LA
	09.96 -	OM 602.985	3606.20.00 3627.30.00	MF362 362WGTTB	
813 D, 814 D (670.321, 670.322, 670.323, 670.324)	09.96 -	OM 900.917	3606.20.00	362	- Engine code: OM904LA
	09.96 -	OM 900.918	3627.30.00	362 18	- Engine code: OM904LA
815 D, 816 D (670.321, 670.322, 670.323, 670.324)	09.96 -	OM 904.908	8540.40.00	KZIS-4	- Engine code: OM904LA
	09.96 -	OM 904.923			

Vehicle list

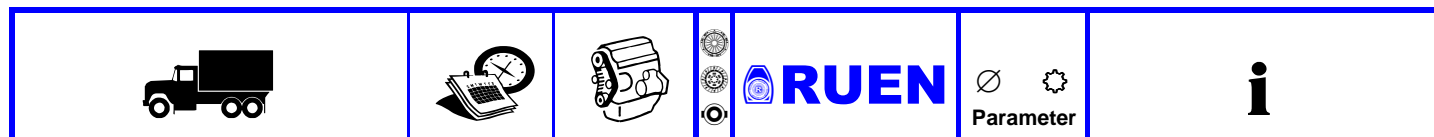

MERCEDES-BENZ

VARIO Cab with engine

09.96 -

810 DT (670.398)	09.96 -	OM 904.904		3620.90.02	362 18	- Engine code: OM904LA
814 DT (670.398)	09.96 -	OM 904.908		3606.20.00	MF362	
816 DT (670.398)	09.96 -	OM 904.923		3627.30.00	362WG7B	
				3606.20.00	362 MF362	- Engine code: OM904LA
				8540.40.00	KZIS-4	- Engine code: OM904LA
				3627.30.00	362 18 362WG7B	- Engine code: OM904LA

206

L 206				2283.20.00	228 M228KR	
				2306.30.00	228 10 228GSB	
				3214.40.00	KZI/T - 1	
L 206 DG (2,4/2,5 to)				2283.20.00	228 M228KR	- To chassis no.: 108506
				2173.20.00	215 M215	- From chassis no.: 108507 - Engine code: OM615
L 206 DG (2,8 to)				2283.20.00	228 M228KR	- Engine code: OM615

306

L 306 L 306 D, 44kW				2283.20.00	228 M228KR	- Engine code: A60
				2306.30.00	228 10 228GSB	
				3214.40.00	KZI/T - 1	
L 306 D, 44kW	06.72 -			2283.20.00	228 M228KR	- Only install if the vehicle is equipped with an M-type clutch
				3214.40.00	KZI/T - 1	- Only install if the vehicle is equipped with an M-type clutch
L 306 DG (3,1/3,5 to) L 306 DG (4,1/5,0 to)				2283.20.00	228 M228KR	- Only install if the vehicle is equipped with an M-type clutch

307

L 307				2283.20.00	228 M228KR	- Only install if the vehicle is equipped with an M-type clutch
-------	--	--	--	-------------------	----------------------	---

311

L,LA,LP,LAP,LG 311				2812.20.00	280 HVB280	
				2812.30.00	280 10 280Z	

312

L,LA,LP,LAP,LG 312				2812.20.00	280 HVB280	
				2812.30.00	280 10 280Z	

315

LP 315				3505.20.00	350 G350KR	
				3552.30.00	350 10 350	

319

L 319 B L 319 D				2283.20.00	228 M228KR	- Only install if the vehicle is equipped with an M-type clutch
				3214.40.00	KZI/T - 1	- Only install if the vehicle is equipped with an M-type clutch

Vehicle list



MERCEDES-BENZ

322

L,LA 322				2812.20.00	280 HVB280	
				2822.30.00	280 10 280GTZ	
				6909.40.00	KZI - 3	
LAK,LAS,LK,LPS,LS 322 LAP 322 LP 322	02.61 - 02.61 -			2812.20.00	280 HVB280	
				2822.30.00	280 10 280GTZ	

323

LA,LAK 323				2812.20.00	280 HVB280	
				2812.30.00	280 10 280Z	

325

L 325				3552.30.00	350 10 350	
-------	--	--	--	-------------------	----------------------	--

326

L,LP 326				3807.20.00	380 G380KR	
----------	--	--	--	-------------------	----------------------	--

329

L 329				3506.20.00	350 G350	- From chassis no.: 9500075
				3552.30.00	350 10 350	
LA 329				3522.20.00	350 GF350KR	
				3552.30.00	350 10 350	
LA 329, 107kW				3506.20.00	350 G350	- From chassis no.: 9500092
				3552.30.00	350 10 350	
LP 329				3506.20.00	350 G350	- From chassis no.: 9500032
				3552.30.00	350 10 350	







330

L 330				3506.20.00	350 G350	- From chassis no.: 9500319
				3552.30.00	350 10 350	

331





L 331				3506.20.00	350 G350	- From chassis no.: 9500062
				3552.30.00	350 10 350	
LA 331				3506.20.00	350 G350	- From chassis no.: 9500009
				3552.30.00	350 10 350	
LP 331				3506.20.00	350 G350	- From chassis no.: 9500129
				3552.30.00	350 10 350	

Vehicle list

					
---	---	---	--	---	---

MERCEDES-BENZ



332

L 332			 3506.20.00	350 G350	- From chassis no.: 9500277
			 3522.20.00	350 GF350KR	
			 3552.30.00	350 10 350	
LA 332			 3506.20.00	350 G350	- From chassis no.: 9500053
			 3552.30.00	350 10 350	

333

LP 333			 3807.20.00	380 G380KR	
--------	--	--	---	----------------------	--

334

L,LA 334			 3822.20.00	380 GF380KR	
L,LP,LK,LS 334			 3807.20.00	380 G380KR	



335

335			 3822.20.00	380 GF380KR	
-----	--	--	---	-----------------------	--



336

336			 3822.20.00	380 GF380KR	
-----	--	--	---	-----------------------	--



337

337			 3522.20.00	350 GF350KR	
			 3502.30.00	350 10 350GSZ	



354

L,LP 354			 3522.20.00	350 GF350KR	
			 3502.30.00	350 10 350GSZ	

405

L 405 D, Van/Estate L 405 D, Platform/Chassis	01.72 - 12.80	OM 615	 2283.20.00	228 M228KR	- Only install if the vehicle is equipped with an M-type clutch
	01.72 - 12.80		 3214.40.00	KZI/T - 1	- Only install if the vehicle is equipped with an M-type clutch

406

L 406 D	- 12.80		 2283.20.00	228 M228KR	- Only install if the vehicle is equipped with an M-type clutch
			 3214.40.00	KZI/T - 1	- Only install if the vehicle is equipped with an M-type clutch

Vehicle list



MERCEDES-BENZ











406						
L 406 DG, Van/Estate L 406 DG, Platform/Chassis	01.68 - 12.74	OM 615.910		2283.20.00	228 M228KR	- To chassis no.: 145736 LHD - To chassis no.: 148036 RHD - Only install if the vehicle is equipped with an M-type clutch - Chassis no.: 145737 LHD - 182065 LHD - Chassis no.: 148037 RHD - 182065 RHD - Chassis no.: 182066 - 556499 - From chassis no.: 556500
	01.68 - 12.74			3214.40.00	KZI/T - 1	- To chassis no.: 145736 LHD - To chassis no.: 148036 RHD - Only install if the vehicle is equipped with an M-type clutch - Chassis no.: 145737 LHD - 182065 LHD - Chassis no.: 148037 RHD - 182065 RHD - Chassis no.: 182066 - 556499 - From chassis no.: 556500
				2306.30.00	228 10 228GSB	- Chassis no.: 145737 LHD - 182065 LHD - Chassis no.: 148037 RHD - 182065 RHD - Chassis no.: 182066 - 556499
				2281.30.00	228 10 228PSD	- From chassis no.: 556500
407						
407 D, Platform/Chassis 407 D, Van/Estate	07.81 - 01.89	OM 616.913		2280.90.02	228 10 M228KR 228CB	
	07.81 - 01.89	OM 616.939		2282.20.00 2307.30.00 3214.40.00	KZI/T - 1	
				2280.90.03	228 10 M228KR 228GSB	
				2283.20.00 2306.30.00 3214.40.00	KZI/T - 1	
L 407 D, Van/Estate L 407 D, Platform/Chassis	01.75 - 12.88	OM 616.910		2283.20.00	228 M228KR	- To chassis no.: 145736 LHD - To chassis no.: 148036 RHD - Only install if the vehicle is equipped with an M-type clutch - Chassis no.: 145737 LHD - 182065 LHD - Chassis no.: 148037 RHD - 182065 RHD - Chassis no.: 182066 - 556499 - From chassis no.: 556500
	01.75 - 12.88			3214.40.00	KZI/T - 1	- To chassis no.: 145736 LHD - To chassis no.: 148036 RHD - Only install if the vehicle is equipped with an M-type clutch - Chassis no.: 145737 LHD - 182065 LHD - Chassis no.: 148037 RHD - 182065 RHD - Chassis no.: 182066 - 556499 - From chassis no.: 556500
				2306.30.00	228 10 228GSB	- Chassis no.: 145737 LHD - 182065 LHD - Chassis no.: 148037 RHD - 182065 RHD - Chassis no.: 182066 - 556499
				2281.30.00	228 10 228PSD	- From chassis no.: 556500
408						
408 D, Platform/Chassis 408 D, Van/Estate	11.88 - 06.95	OM 601.940		2280.90.03	228 10 M228KR 228GSB	
	11.88 - 06.95			2283.20.00 2306.30.00 3214.40.00	KZI/T - 1	
L 408 D				2507.20.00	250 HBX250	
				2528.30.00	250 10 250BHZX	
				6909.40.00	KZI - 3	

Vehicle list

















					
---	---	---	--	---	---

MERCEDES-BENZ





408

L 408 DG, Van/Estate L 408 DG, Platform/Chassis	01.70 - 12.74 01.70 - 12.74	OM 314.948	 2507.20.00	250 HBX250	
			 2528.30.00	250 10 250BHZX	
			 6909.40.00	KZI - 3	- To chassis no.: 145736 LHD - To chassis no.: 148036 RHD
			 6908.40.00	KZ - 3	- From chassis no.: 145737 LHD - To engine no.: 678174 LHD - From chassis no.: 148037 RHD - To engine no.: 678174 RHD
			 2500.90.01  2507.20.00  2528.30.00  6901.40.00	250 10 HBX250 250BHZX KZI - 3	- From engine no.: 678175
L 408 G, 1990cc L 408 G, 2197cc, Van/Estate L 408 G, 2197cc, Platform/Chassis LF 408 G LK 408 G, LK 409 LK 408 G, LK 409, LK 410, 66kW LK 408 G, LK 409, LK 410, 70kW	01.68 - 12.72 08.72 - 12.74 08.72 - 12.74 08.72 - 12.74 01.68 - 12.74 01.75 - 08.82 08.82 - 09.83	M 102.943 M 115.921 M 115.927 M 115.928 M 115.929 M 115.952 M 115.1 M 115.II	 2306.30.00	228 10 228GSB	- To chassis no.: 145736 - To chassis no.: 556499
			 2283.20.00	228 M228KR	- To chassis no.: 145736 - Only install if the vehicle is equipped with an M-type clutch
			 3214.40.00	KZI/T - 1	- To chassis no.: 145736 - Only install if the vehicle is equipped with an M-type clutch - From chassis no.: 184087

409

409 D, Platform/Chassis 409 D, Van/Estate	04.82 - 01.89 04.82 - 01.89	OM 617.913	 2280.90.03  2283.20.00  2306.30.00  3214.40.00	228 10 M228KR 228GSB KZI/T - 1	
			 2280.90.04  2282.20.00  2281.30.00  3214.40.00	228 10 M228KR 228PSD KZI/T - 1	- GBox: ZF - For PTO
L 409, Platform/Chassis L 409, Van/Estate LF 409 G	01.75 - 08.82 01.75 - 08.82 01.75 - 08.82	M 115.952 M 115.970 M 115.971	 2306.30.00	228 10 228GSB	- To chassis no.: 145736 - To chassis no.: 556499
			 2283.20.00	228 M228KR	- To chassis no.: 145736 - Only install if the vehicle is equipped with an M-type clutch
			 3214.40.00	KZI/T - 1	- To chassis no.: 145736 - Only install if the vehicle is equipped with an M-type clutch - To chassis no.: 184086 - From chassis no.: 184087
			 2307.30.00	228 10 228CB	
LKO 409			 2306.30.00	228 10 228GSB	- To chassis no.: 145736 - Chassis no.: 145737 - 556499
			 2283.20.00	228 M228KR	- To chassis no.: 145736 - Only install if the vehicle is equipped with an M-type clutch - From chassis no.: 145737
			 2307.30.00	228 10 228CB	- From chassis no.: 556500
			 3214.40.00	KZI/T - 1	- Chassis no.: 145737 - 184086 - Chassis no.: 184087 - 556499

410

410, Platform/Chassis 410, Van/Estate	08.82 - 06.95 08.82 - 06.95	M 102.942 M 102.945	 2280.90.02  2282.20.00  2307.30.00  3214.40.00	228 10 M228KR 228CB KZI/T - 1	

Vehicle list

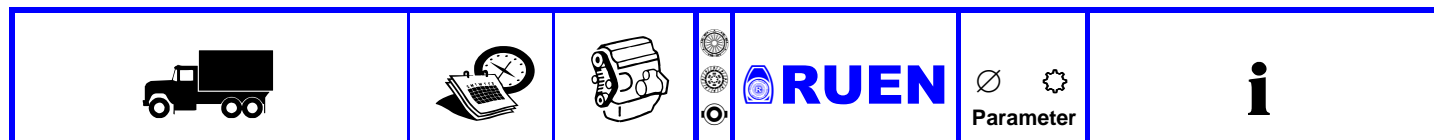

MERCEDES-BENZ

410						
410 D, Platform/Chassis 410 D, Van/Estate	11.88 - 06.95	OM 602.940		2280.90.03	228 10	
	11.88 - 06.95			2283.20.00 2306.30.00 3214.40.00	M228KR 228GSB KZI/T - 1	
				2280.90.04	228 10	
				2282.20.00 2281.30.00 3214.40.00	M228KR 228PSD KZI/T - 1	
L 410, Van/Estate L 410, Platform/Chassis	08.82 - 12.88	M 102.943		2306.30.00	228 10	- To chassis no.: 145736 - To chassis no.: 556499
	08.82 - 12.88			2283.20.00	228	- To chassis no.: 145736 - Only install if the vehicle is equipped with an M-type clutch
				3214.40.00	M228KR	- To chassis no.: 145736 - Only install if the vehicle is equipped with an M-type clutch
				2307.30.00	KZI/T - 1	- To chassis no.: 184086 - From chassis no.: 184087
				228 10	228CB	- From chassis no.: 556500
507						
507 D, Van/Estate 507 D, Platform/Chassis 507 DK	04.86 - 04.89	OM 616.914		2283.20.00	228	
	04.86 - 04.89			2281.30.00	228 10	- To chassis no.: 962132
	04.86 - 04.89			3214.40.00	228PSD	
				2280.90.03	KZI/T - 1	
				2283.20.00 2306.30.00 3214.40.00	228 10	- From chassis no.: 962133
				M228KR 228GSB KZI/T - 1		
508						
508 D, Van/Estate 508 D, Dump Truck	03.89 - 12.94	OM 601.941		2283.20.00	228	
	03.89 - 12.94			2281.30.00	228 10	
				3214.40.00	228PSD	
L 508				2507.20.00	250	- From chassis no.: 145737 LHD - To engine no.: 678174 LHD - From chassis no.: 148037 RHD - To engine no.: 678174 RHD
				2528.30.00	250 10	- From chassis no.: 145737 LHD - To engine no.: 678174 LHD - From chassis no.: 148037 RHD - To engine no.: 678174 RHD
				6908.40.00	250BHZX	- From chassis no.: 145737 LHD - To engine no.: 678174 LHD - From chassis no.: 148037 RHD - To engine no.: 678174 RHD
L 508 D LS 508 D		OM 314		2507.20.00	250	
				2528.30.00	250 10	
				6909.40.00	250BHZX	
L 508 D		OM 601		2283.20.00	228	
				2281.30.00	228 10	
				3214.40.00	228PSD	
				KZI/T - 1		

Vehicle list



MERCEDES-BENZ

508						
L 508 DG, Van/Estate L 508 DG, Platform/Chassis	01.70 - 12.88 01.70 - 12.88	OM 314.946 OM 314.948	2500.90.01	250 10 HBX250 250BHZX KZI - 3		- From engine no.: 678175
			2507.20.00			
			2528.30.00			
			6901.40.00			
			2507.20.00	250 HBX250		- To chassis no.: 145736 LHD - To chassis no.: 148036 RHD
			2528.30.00	250 10 250BHZX		- To chassis no.: 145736 LHD - To chassis no.: 148036 RHD
			6909.40.00	KZI - 3		- To chassis no.: 145736 LHD - To chassis no.: 148036 RHD
LF 508 D			2500.90.01	250 10 HBX250 250BHZX KZI - 3		- From engine no.: 410748
			2507.20.00			
			2528.30.00			
			6901.40.00			
			6908.40.00	KZ - 3		- To engine no.: 410747
LK 508 DG LK 508 DG, 63kW LKO 508 DG, 63 - 63kW	09.72 - 06.88	OM 314.946 OM 314.948 OM 314.959 OM 314.961 OM 314.962 OM 314.963	2500.90.01	250 10 HBX250 250BHZX KZI - 3		- From engine no.: 678175
			2507.20.00			
			2528.30.00			
			6901.40.00			
			6909.40.00	KZI - 3		- To chassis no.: 145736 LHD - To chassis no.: 148036 RHD
			6908.40.00	KZ - 3		- From chassis no.: 145737 LHD - To engine no.: 678174 LHD - From chassis no.: 148037 RHD - To engine no.: 678174 RHD
LKO 508 DG, 63kW	06.72 - 02.77	OM 314.946 OM 314.948	2507.20.00	250 HBX250		
			2528.30.00			
			6909.40.00			
			6908.40.00			
			2507.20.00	250 HBX250		
			2528.30.00	250 10 250BHZX		
			6909.40.00	KZI - 3		- To chassis no.: 145736 LHD - To chassis no.: 148036 RHD
			6908.40.00	KZ - 3		- From chassis no.: 145737 LHD - From chassis no.: 148037 RHD
LP 508 DG			2507.20.00	250 HBX250		
			2528.30.00			
			6908.40.00			
			2507.20.00	250 HBX250		
			2528.30.00	250 10 250BHZX		
			6908.40.00	KZ - 3		
510						
510, Van/Estate 510, Platform/Chassis	04.86 - 12.94 04.86 - 12.94	M 102.946	2283.20.00	228 M228KR		
			2307.30.00			
			3214.40.00			
			2307.30.00	228 10 228CB		
			3214.40.00	KZI/T - 1		
608						
L 608 D, Van/Estate L 608 D, Platform/Chassis LK 608 D	01.70 - 12.88 01.70 - 12.88 02.84 - 12.88	OM 314.946 OM 314.948 OM 314.961 OM 314.963 OM 314.967	2500.90.01	250 10 HBX250 250BHZX KZI - 3		- From engine no.: 410748
			2507.20.00			
			2528.30.00			
			6901.40.00			
			6909.40.00	KZI - 3		- To chassis no.: 145736 LHD - To chassis no.: 148036 RHD
			6908.40.00	KZ - 3		- From chassis no.: 145737 - To engine no.: 410747







Vehicle list



MERCEDES-BENZ







608							
LP 608,LPL 608 LPS 608,LPLS 608	09.63 - 12.84	OM 314.910		2500.90.01	250 10	- From engine no.: 410748	
	09.63 - 12.84	OM 314.944 OM 314.964 OM 314.965	 	2507.20.00 2528.30.00 6901.40.00	HBX250 250BHZX KZI - 3		
				6909.40.00	KZI - 3	- To chassis no.: 4282707	
				6908.40.00	KZ - 3	- To engine no.: 410747	
LPK 608 LPKF 608 LPKO 608	10.69 - 10.77	OM 314.910		2500.90.01	250 10	- From engine no.: 410748	
	09.63 - 12.84	OM 314.944	 	2507.20.00 2528.30.00 6901.40.00	HBX250 250BHZX KZI - 3		
	02.66 - 07.77			6909.40.00	KZI - 3	- To chassis no.: 4282707	
				6908.40.00	KZ - 3	- From chassis no.: 4282708 - To engine no.: 410747	
LT 608 D				2500.90.01	250 10		
			 	2507.20.00 2528.30.00 6901.40.00	HBX250 250BHZX KZI - 3		
609							
609 D, 63 - 66kW, Van/Estate	04.86 - 12.94	OM 354.902		2800.90.01	280 10		
609 D, 63 - 66kW, Platform/Chassis	04.86 - 12.94	OM 364.906	 	2837.20.00 2822.30.00 5700.40.00	MFZ280 280GTZ KZIZ - 3		
609 DK	04.86 - 12.94	OM 364.919					
609 D, 77kW, Van/Estate	06.94 - 12.94						
609 D, 77kW, Platform/Chassis	06.94 - 12.94						
613							
L 613 D	04.77 - 12.88	OM 353.963		2845.20.00	280		
	04.77 - 12.88	OM 353.966	 	2822.30.00	280 10		
				6901.40.00	KZI - 3		
709							
709 709 K	03.84 - 12.98	OM 364.907		2826.20.00	280		
	03.84 - 10.90	OM 364.918	 	2822.30.00 3164.20.00 3124.30.00 6901.40.00	MF280 280 10 280GTZ 310 MF310 310 10 310GSBL	- Special design - Special design	
				2800.90.01	280 10		
				 	2837.20.00 2822.30.00 5700.40.00	MFZ280 280GTZ KZIZ - 3	
					6901.40.00	KZI - 3	
709 D, Van/Estate	04.86 - 12.94	OM 364.906		2800.90.01	280 10		
709 D, Platform/Chassis	04.86 - 12.94	OM 364.912					
709 DK	04.86 - 12.99	OM 364.921					
LP 709,LPL 709 LPK 709 LPKF 709 LPS 709,LPLS 709	09.63 - 12.84	OM 314.910		2500.90.01	250 10	- From engine no.: 678175	
	11.77 - 12.84	OM 314.944	 	2507.20.00 2528.30.00 6901.40.00	HBX250 250BHZX KZI - 3		
	11.77 - 12.84	OM 314.964		6909.40.00	KZI - 3	- To chassis no.: 4282707	
	09.63 - 12.84	OM 314.965		6908.40.00	KZ - 3	- From chassis no.: 4282708 - To engine no.: 678174	

Vehicle list





					
---	---	---	--	---	---

MERCEDES-BENZ













709

LPKO 709	02.66 - 07.77	OM 314.910 OM 314.944	 2500.90.01	250 10 HBX250 250BHZX KZI - 3	- From engine no.: 410748
			 2507.20.00		
			 2528.30.00		
			 6901.40.00		
			 6909.40.00	KZI - 3	- To chassis no.: 4282707
			 6908.40.00	KZ - 3	- From chassis no.: 4282708 - To engine no.: 678174





710

L,LK,LS 710			 2812.20.00	280 HVB280	
			 2812.30.00	280 10 280Z	
LF,LAF,LPF 710 SA 015 052/01			 2812.20.00	280 HVB280	
			 2822.30.00	280 10 280GTZ	











711

711, 77kW	03.94 - 12.98	OM 354.900	 3164.20.00	310 MF310	
			 3136.30.00	310 10 310WGSZ	
			 6901.40.00	KZI - 3	
711, 90kW	03.96 - 12.98	OM 904.905	 3620.90.02	362 18 MF362 362WGTB	
			 3606.20.00		
			 3627.30.00		
			 5700.40.00	KZIZ - 3	
711 D, Van/Estate 711 D, Platform/Chassis	04.86 - 12.94	OM 354.902 OM 354.903	 3100.90.02	310 10 MFZ310 310GSBL KZIZ - 3	
			 3176.20.00		
	 3126.30.00				
	 5700.40.00				
					 3136.30.00
	04.86 - 12.94	OM 364.950 OM 364.952 OM 364.957			

714

714 D, Van/Estate 714 D, Platform/Chassis	06.94 - 12.94	OM 354.923	 3100.90.02	310 10 MFZ310 310GSBL KZIZ - 3	
			 3176.20.00		
	 3126.30.00				
	 5700.40.00				
					 3136.30.00
	06.94 - 12.94				

808

LP 808,LPL 808 LPK 808 LPKF 808, LPKF 809	09.63 - 12.84	OM 314.910 OM 314.944	 2500.90.01	250 10 HBX250 250BHZX KZI - 3	- From engine no.: 410748
			 2507.20.00		
	 2528.30.00				
	 6901.40.00				
			 6908.40.00	KZ - 3	- From chassis no.: 4282708 - To engine no.: 410747
LPL 808			 2500.90.01	250 10 HBX250 250BHZX KZI - 3	- From engine no.: 678175
			 2507.20.00		
			 2528.30.00		
			 6901.40.00		
			 6908.40.00	KZ - 3	- To engine no.: 678174

Vehicle list



MERCEDES-BENZ

809

809 809 K	03.84 - 12.98	OM 364.907		2826.20.00	280 MF280	
	03.84 - 12.98	OM 364.918		2822.30.00	280 10 280GTZ	
				3164.20.00	310 MF310	- Equipment Var: SA24481-01 - Special design
				3124.30.00	310 10 310GSBL	- Equipment Var: SA24481-01 - Special design
				6901.40.00	KZI - 3	
809 D, Van/Estate 809 D, Platform/Chassis 809 DK 809 DT	04.86 - 12.94	OM 364.906		2800.90.01	280 10 MFZ280	
	04.86 - 12.94	OM 364.911		2837.20.00	280GTZ	
	04.86 - 12.94	OM 364.920		2822.30.00	KZIZ - 3	
	04.86 - 12.94	OM 364.921		5700.40.00		
				2837.20.00	280 MFZ280	- Equipment Var: SA33611-01 - Special design
LP 809, LPL 808, LPL 809	09.63 - 12.84	OM 314.910		2500.90.01	250 10 HBX250	- From engine no.: 410748
		OM 314.944		2507.20.00	250BHZX	- From engine no.: 678175
		OM 314.964		2528.30.00	KZI - 3	
		OM 314.965		6901.40.00		
				2507.20.00	250 HBX250	
LPK 809	11.77 - 12.84	OM 314.910		2500.90.01	250 10 HBX250	- From engine no.: 410748
		OM 314.944		2507.20.00	250BHZX	
				2528.30.00	KZI - 3	
				6909.40.00	KZI - 3	- To chassis no.: 4282707
				6908.40.00	KZ - 3	- From chassis no.: 4282708 - To engine no.: 410747 - To engine no.: 678174

810

L,LP 810				2812.20.00	280 HVB280	- To engine no.: 040605
				2822.30.00	280 10 280GTZ	- To engine no.: 040605

811

811				2845.20.00	280 HVB280	
				2822.30.00	280 10 280GTZ	
				6909.40.00	KZI - 3	
811, 77kW 811 K, 77kW	03.94 - 12.98	OM 354.900		3164.20.00	310 MF310	
				3136.30.00	310 10 310WGSZ	
				6901.40.00	KZI - 3	
811, 90kW 811 K, 90kW	03.96 - 12.98	OM 904.905		3620.90.01	362 18 MF362	
				3606.20.00	362WGTB	
				3627.30.00	KZIS-4	
				8536.40.00		

Vehicle list



MERCEDES-BENZ

811

811 D, Van/Estate 811 D, Platform/Chassis 811 DK	04.86 - 12.94 04.86 - 12.94 04.86 - 12.94	OM 354.901 OM 354.903 OM 364.950 OM 364.952 OM 364.958	3100.90.02 3176.20.00 3126.30.00 5700.40.00	310 10 MFZ310 310GSBL KZIZ - 3	
LP 811	10.69 - 02.73	OM 352	3120.20.00	310 GFX310	- To chassis no.: 922885
			3101.20.00	310 GFX310	- From chassis no.: 922886 - To engine no.: 393780
			3124.30.00	310 10 310GSBL	- From chassis no.: 922886 - To engine no.: 393780
			6909.40.00	KZI - 3	- To engine no.: 393780 - To chassis no.: 4282707 - From engine no.: 393781
			2845.20.00	280 HVB280	- To chassis no.: 4282707 - From engine no.: 393781 - From chassis no.: 4282708
			2822.30.00	280 10 280GTZ	- To chassis no.: 4282707 - From engine no.: 393781 - From chassis no.: 4282708
			6908.40.00	KZ - 3	- From chassis no.: 4282708 - To engine no.: 678174
			6901.40.00	KZI - 3	- From engine no.: 678175
LPK 811			2845.20.00	280 HVB280	- From engine no.: 393781
			2822.30.00	280 10 280GTZ	- From engine no.: 393781
			6908.40.00	KZ - 3	- From chassis no.: 4282708 - To engine no.: 678174
			6901.40.00	KZI - 3	- From engine no.: 678175
			3120.20.00	310 GFX310	- To chassis no.: 922885
			3101.20.00	310 GFX310	- From chassis no.: 922886 - To engine no.: 393780
			3124.30.00	310 10 310GSBL	- To engine no.: 393780
			6909.40.00	KZI - 3	
LPS 811	10.69 - 02.73	OM 352	3120.20.00	310 GFX310	- To chassis no.: 922885
			3101.20.00	310 GFX310	- From chassis no.: 922886 - To engine no.: 393780
			3124.30.00	310 10 310GSBL	- To engine no.: 393780
			6909.40.00	KZI - 3	- To engine no.: 393780 - To chassis no.: 4282707 - From engine no.: 393781
			2845.20.00	280 HVB280	- To chassis no.: 4282707 - From engine no.: 393781 - From chassis no.: 4282708
			2822.30.00	280 10 280GTZ	- To chassis no.: 4282707 - From engine no.: 393781 - From chassis no.: 4282708
			6908.40.00	KZ - 3	- From chassis no.: 4282708 - To engine no.: 678174
			6901.40.00	KZI - 3	- From engine no.: 678175

Vehicle list



MERCEDES-BENZ

813

LP 813,LPL 813 318.052, 318.054, 318.251, 318.254, 318.051, 318.053, 318.253, 318.252 LPK 813 318.072 LPS 813,LPLS 813 318.251, 318.254, 318.270, 318.070, 318.252	09.63 - 12.84	OM 353.904 OM 353.965		2845.20.00	280 HVB280	- From engine no.: 393781	
	03.73 - 12.84	OM 353.981		2822.30.00	280 10 280GTZ	- From engine no.: 393781	
				6909.40.00	KZI - 3	- To chassis no.: 4282707 - From engine no.: 393781 - To engine no.: 393780	
	09.63 - 12.84				6908.40.00	KZ - 3	- From chassis no.: 4282708 - To engine no.: 678174
					6901.40.00	KZI - 3	- From engine no.: 678175
					3120.20.00	310 GFX310	- To chassis no.: 922885
					3101.20.00	310 GFX310	- From chassis no.: 922886 - To engine no.: 393780
					3124.30.00	310 10 310GSBL	- To chassis no.: 922885 - Special design
					3164.20.00	310 MF310	- Special design
				2845.20.00	280 HVB280	- From chassis no.: 4367142	
LPL 813 318.251-254				2822.30.00	280 10 280GTZ	- From chassis no.: 4367142	
				6908.40.00	KZ - 3	- From chassis no.: 4367142 - To engine no.: 678174	
				6901.40.00	KZI - 3	- From engine no.: 678175	
				3164.20.00	310 MF310	- Special design	
				3124.30.00	310 10 310GSBL	- Special design	
LPLS 813 318.270				2845.20.00	280 HVB280	- From chassis no.: 4367142	
				2822.30.00	280 10 280GTZ	- From chassis no.: 4367142	
				6908.40.00	KZ - 3	- From chassis no.: 4367142 - To engine no.: 678174	
				6901.40.00	KZI - 3	- From engine no.: 678175	
				3101.20.00	310 GFX310		
				3126.30.00	310 10 310GSBL		
				3124.30.00	310 10 310GSBL	- Special design	
				3164.20.00	310 MF310	- Special design	

814

814 D, Van/Estate	11.87 - 12.94	OM 354.924 OM 364.981 OM 364.986		3176.20.00	310 MFZ310	
				3126.30.00	310 10 310GSBL	
				5700.40.00	KZIZ - 3	
814 D, Platform/Chassis 814 DA, Van/Estate 814 DA, Platform/Chassis	11.87 - 12.94	OM 354.924		3176.20.00	310 MFZ310	
	11.87 - 12.94	OM 364.981		3126.30.00	310 10 310GSBL	
	11.87 - 12.94	OM 364.986		3136.30.00	310 10 310WGSZ	
				5700.40.00	KZIZ - 3	

Vehicle list



MERCEDES-BENZ

814

814 F, 95 - 100kW 814 K, 95 - 100kW 814 S, 95 - 100kW 814,814L, 95 - 100kW	05.86 - 12.98 03.84 - 12.98 03.84 - 12.98 01.84 - 12.98	OM 356.901 OM 356.902 OM 356.905 OM 356.911 OM 366.905 OM 366.906 OM 366.907 OM 366.910	3100.90.12 3164.20.00 3136.30.00 6901.40.00	310 10 MF310 310WGSZ KZI - 3	
814 F, 100kW 814 K, 100kW 814 S, 100kW 814,814L, 100kW	03.96 - 12.98 03.96 - 12.98 03.96 - 12.98 03.96 - 12.98	OM 904.906	3620.90.01 3606.20.00 3627.30.00 8536.40.00	362 18 MF362 362WG TB KZIS-4	
814 F 814 K 814 S 814,814 L	03.94 - 12.98 03.94 - 12.98 03.94 - 12.98 01.84 - 12.98	OM 354.920 OM 354.922	3164.20.00 3136.30.00 6901.40.00 3300.90.04 3300.20.00 3325.30.00 6901.40.00	310 10 MF310 310WGSZ KZI - 3 330 10 GFM330 330WGSZ KZI - 3	

817

817 F, 116 - 125kW 817 K, 116 - 125kW 817 S,817 LS, 116 - 125kW 817,817 L, 116 - .125kW	03.84 - 12.98 01.86 - 12.98 01.84 - 12.98 01.84 - 12.98	OM 356.951 OM 357.900 OM 357.908 OM 357.916 OM 366.942 OM 366.943 OM 366.967 OM 366.968 OM 366.973	3305.20.00 3325.30.00 6901.40.00 3580.20.00 3517.30.00 8529.40.00	330 10 GMF330 330WGSZ KZI - 3 350 10 GMF350 350WGSZ KZI - 4,5	- GBox: G4 - GBox: G4 - GBox: G4
817 F, 125kW 817 K, 125kW 817 S,817 LS, 125kW 817,817 L, 125kW	03.96 - 12.98 03.96 - 12.98 03.96 - 12.98 03.96 - 12.98	OM 904.907	3620.90.01 3606.20.00 3627.30.00 8536.40.00	362 18 MF362 362WG TB KZIS-4	

911

L 911	01.72 - 07.83	OM 352.911	2812.20.00 2822.30.00 6909.40.00	280 10 HVB280 280GTZ KZI - 3	- To chassis no.: 012769 - To chassis no.: 012769
L,LA 911			2953.20.00 2954.30.00 6909.40.00	295 10 GF295 295BHZ KZI - 3	- Special design - Special design - Special design
L,LA LP 911			2812.20.00 2822.30.00	280 10 HVB280 280GTZ	- Special design - Special design

Vehicle list



MERCEDES-BENZ

911

L,LP 911			2812.20.00	280 HVB280	- Special design - To engine no.: 040605
			2822.30.00	280 10 280GTZ	- Special design - To engine no.: 040605
			6909.40.00	KZI - 3	- Special design
LA 911			2812.20.00	280 HVB280	
			2812.30.00	280 10 280Z	
LA,LK 911 B LAK,LAF,LAKO 911 B LAS 911 B LS 911 B			2812.20.00	280 HVB280	- To chassis no.: 760271 - Not for chassis no.: 500001-599999
			2822.30.00	280 10 280GTZ	- To chassis no.: 760271 - Not for chassis no.: 500001-599999
			6909.40.00	KZI - 3	- To chassis no.: 760271 - From chassis no.: 760272 - Chassis no.: 500001 - 599999
			2953.20.00	295 GF295	- From chassis no.: 760272 - Chassis no.: 500001 - 599999
			2954.30.00	295 10 295BHZ	- From chassis no.: 760272 - Chassis no.: 500001 - 599999
LK 911 LKO 911 LS 911	01.72 - 07.83	OM 352.911	2812.20.00	280 HVB280	
			2822.30.00	280 10 280GTZ	
			6909.40.00	KZI - 3	
			2953.20.00	295 GF295	
			2954.30.00	295 10 295BHZ	
LP 911 B	01.67 - 03.77	OM 352.907 OM 352.986	2812.20.00	280 HVB280	- To engine no.: 040605
			2822.30.00	280 10 280GTZ	- To engine no.: 040605
			2953.20.00	295 GF295	- From engine no.: 040606
			2954.30.00	295 10 295BHZ	- From engine no.: 040606
			6909.40.00	KZI - 3	- From engine no.: 040606
			3122.20.00	310 GFX310	
			3126.30.00	310 10 310GSBL	
LPK 911 B LPS 911 B			2812.20.00	280 HVB280	
			2822.30.00	280 10 280GTZ	
			6909.40.00	KZI - 3	
LT 911 B			3101.20.00	310 GFX310	
			3126.30.00	310 10 310GSBL	
			3124.30.00	310 10 310GSBL	
			6909.40.00	KZI - 3	

Vehicle list



MERCEDES-BENZ

913

LP 913, LPL 913	09.63 - 12.84	OM 353.904 OM 353.965 OM 353.981 OM 353.982		3122.20.00	310 GFX310	- To chassis no.: 922885
				3101.20.00	310 GFX310	- From chassis no.: 922886 - To engine no.: 393780
				3124.30.00	310 10 310GSBL	- To engine no.: 393780 - Special design
				6909.40.00	KZI - 3	- To engine no.: 393780 - To chassis no.: 4282707 - From engine no.: 393781
				2845.20.00	280 HVB280	- To chassis no.: 4282707 - From engine no.: 393781 - From chassis no.: 4282708 - From chassis no.: 4367142
				2822.30.00	280 10 280GTZ	- To chassis no.: 4282707 - From engine no.: 393781 - From chassis no.: 4282708 - From chassis no.: 4367142
				6908.40.00	KZ - 3	- From chassis no.: 4282708 - To engine no.: 678174 - From chassis no.: 4367142 - To engine no.: 678174 - Special design
				6901.40.00	KZI - 3	- From engine no.: 678175 - Special design
				3164.20.00	310 MF310	- Special design
LPK 913 LPS 913	01.67 - 12.84 10.69 - 12.84	OM 353.904		3122.20.00	310 GFX310	- To chassis no.: 922885
				3101.20.00	310 GFX310	- From chassis no.: 922886 - To engine no.: 393780
				3124.30.00	310 10 310GSBL	- To engine no.: 393780
				6909.40.00	KZI - 3	- To engine no.: 393780 - To chassis no.: 4282707 - From engine no.: 393781
				2845.20.00	280 HVB280	- To chassis no.: 4282707 - From engine no.: 393781 - From chassis no.: 4282708
				2822.30.00	280 10 280GTZ	- To chassis no.: 4282707 - From engine no.: 393781 - From chassis no.: 4282708
				6908.40.00	KZ - 3	- From chassis no.: 4282708 - To engine no.: 678174
				6901.40.00	KZI - 3	- From engine no.: 678175

914

914 914 AK, 95 - 100kW 914 AK, 125kW 914 K 914 KO	03.84 - 12.98 02.87 - 12.98 02.87 - 12.98 03.84 - 12.98 01.87 - 12.98	OM 356.901 OM 356.903 OM 366.905 OM 366.907 OM 366.918 OM 366.930 OM 366.944 OM 366.945		3100.90.12	310 10	
				3164.20.00	MF310	
				3136.30.00	310WGSZ	
				6901.40.00	KZI - 3	
				3300.90.04	330 10	
				3300.20.00	GFM330	
				3325.30.00	330WGSZ	
				6901.40.00	KZI - 3	

917

917, 4249cc 917 K 676.341, 4249cc 917 KO 676.390, 4249cc	03.96 - 12.98 03.96 - 12.98 03.96 - 12.98	OM 904.907		3620.90.01	362 18	- Engine code: OM904LA
				3606.20.00	MF362	
				3627.30.00	362WG TB	
				8536.40.00	KZIS-4	
				3627.30.00	362 18 362WG TB	- Engine code: OM904LA

Vehicle list



MERCEDES-BENZ

917							
917 676.008, 676.006, 676.007, 676.009, 5958cc 917 AF 676.197, 676.183, 676.184, 676.185, 676.196, 676.195, 676.198, 676.182 917 AK 676.142, 676.143 917 K 676.041, 5958cc 917 KO 676.090, 5958cc	03.94 - 12.98	OM 356.941		3305.20.00	330 GMF330		
	02.87 - 12.98	OM 357.900		3325.30.00	330 10 330WGSZ		
	03.94 - 12.98	OM 357.901		6901.40.00	KZI - 3		
	03.94 - 12.98	OM 357.906					
03.94 - 12.98	OM 357.909	OM 357.910					
03.94 - 12.98	OM 357.918	OM 366.966					
03.94 - 12.98	OM 366.974	OM 366.978					
917 AK 674.144				3100.90.12	310 10 MF310		
				3164.20.00	310WGSZ		
				3136.30.00	KZI - 3		
				6901.40.00			
917 676.306, 676.308, 676.307, 676.309	03.96 - 12.98	OM 904.907		3620.90.01	362 18 MF362		
				3606.20.00	362WGTB		
				3627.30.00	362 18 362WGTB	- Engine code: OM904LA	
				3627.30.00			
1013							
1013 1013 A 1013 AK 1013 K	02.76 - 12.84	OM 353.942		2845.20.00	280 HVB280	- To chassis no.: 4276890	
	02.76 - 12.86	OM 353.943		2822.30.00	280 10 280GTZ	- To chassis no.: 4276890	
	02.76 - 12.84	OM 353.945		6908.40.00	KZ - 3	- To chassis no.: 4696330 - Chassis no.: 4276891 - 4696330	
	02.76 - 12.84	OM 353.946		3164.20.00	310 MF310	- From chassis no.: 4276891	
					3126.30.00	310 10 310GSBL	- Chassis no.: 4276891 - 4696330 - From chassis no.: 4276891
					3124.30.00	310 10 310GSBL	- Chassis no.: 4276891 - 4696330 - From chassis no.: 4276891
					6901.40.00	KZI - 3	- From chassis no.: 4696331
					6901.40.00		
1013 B				2812.20.00	280 HVB280	- To chassis no.: 760271	
				2822.30.00	280 10 280GTZ	- To chassis no.: 760271	
				6909.40.00	KZI - 3	- To chassis no.: 760271 - From chassis no.: 760272 - Special design	
					2953.20.00	295 GF295	- From chassis no.: 760272
					2954.30.00	295 10 295BHZ	- From chassis no.: 760272
					3119.20.00	310 GFX310	- Special design
					3126.30.00	310 10 310GSBL	- Special design
1013 KO	02.76 - 12.84	OM 353.943		3164.20.00	310 MF310		
		OM 353.945		3124.30.00	310 10 310GSBL		
		OM 353.946		6901.40.00	KZI - 3		

Vehicle list

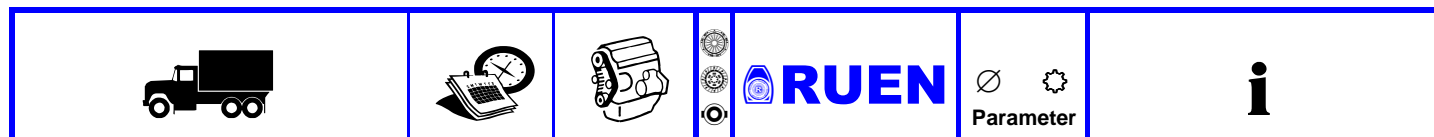

MERCEDES-BENZ

1013

1013 S	02.76 - 12.84	OM 353.942 OM 353.943 OM 353.946		3164.20.00	310 MF310	
				3126.30.00	310 10 310GSBL	
				3124.30.00	310 10 310GSBL	
				6901.40.00	KZI - 3	
LP 1013 LP 1013, LPL 1013 LPK 1013	11.76 - 12.84	OM 353.904		2845.20.00	280 HVB280	
	11.76 - 12.84	OM 353.914		2822.30.00	280 10 280GTZ	
	11.76 - 12.84	OM 353.965 OM 353.981 OM 353.982		6908.40.00	KZ - 3	- To engine no.: 678174 - Special design
				6901.40.00	KZI - 3	- From engine no.: 678175 - Special design
				3164.20.00	310 MF310	- Special design
				3124.30.00	310 10 310GSBL	- Special design
LP,LK,LA,LPK 1013				3101.20.00	310 GFX310	
				3124.30.00	310 10 310GSBL	

1017

1017 1017 A 1017 AF 1017 AK 1017 AS 1017 K 1017 S,1017 LS	11.75 - 02.91	OM 353.950		3164.20.00	310 MF310	- To chassis no.: 4275350
	11.75 - 02.91	OM 353.952		3126.30.00	310 10 310GSBL	- To chassis no.: 4275350
	11.75 - 09.85	OM 353.953		6901.40.00	KZI - 3	- To chassis no.: 4275350 - From chassis no.: 4275351 - From chassis no.: 4275670 - For: Turbo - From model year: 06.1977
	02.76 - 12.84	OM 353.954		3300.20.00	330 GFM330	- From chassis no.: 4275351 - From chassis no.: 4275670 - For: Turbo - From model year: 06.1977
	04.77 - 09.85	OM 353.970		3300.30.00	330 10 330GSZ	- From chassis no.: 4275351 - From chassis no.: 4275670 - For: Turbo - From model year: 06.1977
	02.76 - 12.84	OM 353.971		3300.20.00	330 GFM330	- From chassis no.: 4275351
08.73 - 09.96	OM 353.975		3300.30.00	330 10 330GSZ	- From chassis no.: 4275351	
1017 KO,1017 F	08.73 - 09.96	OM 353.952 OM 353.953 OM 353.954		3164.20.00	310 MF310	- To chassis no.: 4275350
				3126.30.00	310 10 310GSBL	- To chassis no.: 4275350
				6901.40.00	KZI - 3	- To chassis no.: 4275350 - From chassis no.: 4275351
				3300.20.00	330 GFM330	- From chassis no.: 4275351
				3300.30.00	330 10 330GSZ	- From chassis no.: 4275351

1019

1019 AF 1019 F	01.79 - 12.82	OM 401.919		3580.20.00	350 GMF350	
	01.79 - 12.82	OM 401.922		3564.30.00	350 10 350GSZ	
	01.79 - 12.82	OM 401.924		8509.40.00	KZI - 4,5	
				3821.20.00	380 GF380KR	- Special design
				3821.30.00	380 10 380GSZ	- Special design
				8500.40.00	KZI - 4,5	- Special design

Vehicle list



MERCEDES-BENZ

1113						
L,LA 1113 SA 016 655/2			2953.20.00	295 GF295		
			2954.30.00	295 10 295BHZ		
			6909.40.00	KZI - 3		
L,LA,LK,LP,LS 1113 B LAK,LAS,LPK,LPS 1113 B L,LK,LS,LKO 1113 B			2812.20.00	280 HVB280	- To chassis no.: 760271 - Not for chassis no.: 500001 - 599999	
			2822.30.00	280 10 280GTZ	- To chassis no.: 760271 - Not for chassis no.: 500001 - 599999	
			2953.20.00	295 GF295	- From chassis no.: 760272 - Chassis no.: 500001 - 599999	
			2954.30.00	295 10 295BHZ	- From chassis no.: 760272 - Chassis no.: 500001 - 599999	
			6909.40.00	KZI - 3		
			6909.40.00	KZI - 3		
L,LA,LP 1113			2812.20.00	280 HVB280		
			2822.30.00	280 10 280GTZ		
			6909.40.00	KZI - 3		
L,LA,LP 1113 B			3122.20.00	310 GFX310		
			3126.30.00	310 10 310GSBL		
LF,LAF 1113 B			3122.20.00	310 GFX310	- To chassis no.: 922885	
			3119.20.00	310 GFX310	- From chassis no.: 922886	
			3126.30.00	310 10 310GSBL		
			6909.40.00	KZI - 3		
LP 1113, LPL 1113	01.80 - 12.84	OM 353.904 OM 353.965 OM 353.982	3164.20.00	310 MF310		
			3126.30.00	310 10 310GSBL		
			3124.30.00	310 10 310GSBL		
			6908.40.00	KZ - 3	- To engine no.: 678174	
			6901.40.00	KZI - 3	- From engine no.: 678175	
LP,LPK,LPS,LPF 1113			3119.20.00	310 GFX310	- Special design	
			3126.30.00	310 10 310GSBL	- Special design	
			6909.40.00	KZI - 3	- Special design	
1114						
1114,1114 L 1114 K 1114 S	01.84 - 12.98 03.84 - 12.98 03.84 - 12.98	OM 356.904 OM 366.907 OM 366.914 OM 366.930	3100.90.12	310 10 MF310 310WGSZ KZI - 3		
			3164.20.00			
			3136.30.00			
			6901.40.00			
			3300.90.04	330 10 GFM330 330WGSZ KZI - 3		
			3300.20.00 3325.30.00 6901.40.00			
1114 A 1114 AK	02.87 - 12.98 02.87 - 12.98	OM 356.903 OM 356.916 OM 366.918 OM 366.931 OM 366.935	3100.90.12	310 10 MF310 310WGSZ KZI - 3		
			3164.20.00			
			3136.30.00			
			6901.40.00			

Vehicle list



MERCEDES-BENZ

1117						
1117,1117 L, 116 - 125kW 1117 K, 116 - 125kW 1117 S,1117 LS	01.84 - 12.98 04.84 - 12.98 01.84 - 12.98	OM 357.901 OM 357.918 OM 366.941 OM 366.953 OM 366.962 OM 366.970	3305.20.00	330 GMF330		
			3325.30.00	330 10 330WGSZ		
			6901.40.00	KZI - 3		
			3580.20.00	350 GMF350	- GBox: G4 - Special design	
			3517.30.00	350 10 350WGSZ	- GBox: G4 - Special design	
			8529.40.00	KZI - 4,5	- GBox: G4 - Special design	
1117,1117 L, 125kW 1117 K, 125kW 1117 S	03.96 - 12.98 03.96 - 12.98 03.96 - 12.98	OM 904.907	3620.90.01	362 18 MF362 362WGTB KZIS-4		
			3606.20.00			
			3627.30.00			
			8536.40.00			
1117 A 1117 AK	06.87 - 12.98 04.84 - 12.98	OM 356.947 OM 356.959 OM 357.902 OM 357.906 OM 357.907 OM 366.966 OM 366.975 OM 366.976	3305.20.00	330 GMF330		
			3325.30.00	330 10 330WGSZ		
			6901.40.00	KZI - 3		
1120						
1120,1120 L	01.84 - 12.98	OM 356.986 OM 356.992 OM 357.920 OM 357.927 OM 357.932 OM 366.988	3580.20.00	350 GMF350		
			3583.30.00	350 10 350GSZ		
			8529.40.00	KZI - 4,5		
			3822.20.00	380 GF380KR		
			3821.30.00	380 10 380GSZ		
1120 AF 1120 F 1120 L	02.87 - 12.98 02.90 - 12.98 08.84 - 12.98	OM 356.994 OM 356.995 OM 356.996 OM 366.962 OM 366.992 OM 366.994	3500.90.04	350 10 MF350 350GSZ KZIS - 3		
			3573.20.00			
			3587.30.00			
			6905.40.00			
1120 S,1120 LS	01.84 - 12.98	OM 356.986 OM 357.920 OM 357.927 OM 357.932 OM 366.988	3500.90.04	350 10 MF350 350GSZ KZIS - 3		
			3573.20.00			
			3587.30.00			
			6905.40.00			
			3822.20.00		380 GF380KR	
3821.30.00	380 10 380GSZ					
8529.40.00	KZI - 4,5					
1121						
1121 L			3580.20.00	350 GMF350		
			3583.30.00	350 10 350GSZ		
			8529.40.00	KZI - 4,5		
L,LA,LP,LAP 321 SA 015 052/01			2812.20.00	280 HVB280		
			2822.30.00	280 10 280GTZ		

Vehicle list

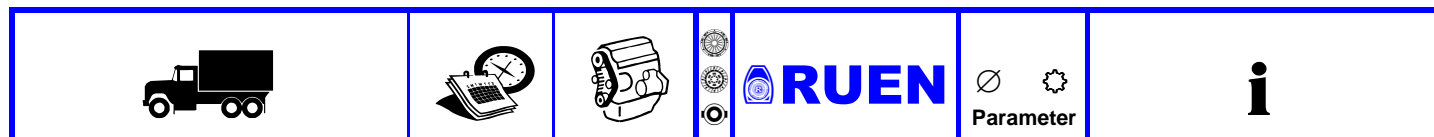

MERCEDES-BENZ

1124

1124 AF	03.92 - 12.98	OM 356.979	3500.90.04	350 10	
1124 F	03.92 - 12.98	OM 356.983 OM 356.989 OM 356.991 OM 357.933 OM 357.942 OM 357.943 OM 357.944	3573.20.00 3587.30.00 6905.40.00	MF350 350GSZ KZIS - 3	

1213

1213	09.97 - 05.86	OM 353.943	3164.20.00	310 MF310	- To chassis no.: 4696330
1213 A	09.75 - 05.86	OM 353.944	3124.30.00	310 10 310GSBL	- To chassis no.: 4696330
1213 K	09.75 - 05.86	OM 353.945	6908.40.00	KZ - 3	- To chassis no.: 4696330
1213 S	09.75 - 05.86	OM 353.946			
1213 AK	09.75 - 05.86	OM 353.943	3164.20.00	310 MF310	
1213 AKO	09.75 - 05.86	OM 353.944	3124.30.00	310 10 310GSBL	
1213 KO	09.75 - 05.86	OM 353.945 OM 353.946	6908.40.00	KZ - 3	
			6901.40.00	KZI - 3	- From chassis no.: 4696331
1213 AS	09.75 - 05.86	OM 353.943 OM 353.944 OM 353.945 OM 353.946	3164.20.00	310 MF310	
			3124.30.00	310 10 310GSBL	
			6908.40.00	KZ - 3	
1213 K.S.A			3164.20.00	310 MF310	- From chassis no.: 4696331
			3124.30.00	310 10 310GSBL	- From chassis no.: 4696331
			6901.40.00	KZI - 3	- From chassis no.: 4696331
L,LA,LP,LS 1213			2953.20.00	295 GF295	
			2954.30.00	295 10 295BHZ	
			6909.40.00	KZI - 3	
LP,LPK 1213			3119.20.00	310 GFX310	- Special design
			3126.30.00	310 10 310GSBL	- Special design
			6909.40.00	KZI - 3	- Special design
LP,LPK,LPS 1213			2953.20.00	295 GF295	- To chassis no.: 760271
			2954.30.00	295 10 295BHZ	- To chassis no.: 760271
			6909.40.00	KZI - 3	- To chassis no.: 760271 - From chassis no.: 760272 - Special design
			3120.20.00	310 GFX310	- Chassis no.: 760272 - 922885
			3101.20.00	310 GFX310	- From chassis no.: 922886
			3124.30.00	310 10 310GSBL	- From chassis no.: 760272
			3122.20.00	310 GFX310	- To chassis no.: 922885
			3119.20.00	310 GFX310	- From chassis no.: 922886
			3126.30.00	310 10 310GSBL	- Special design

Vehicle list



MERCEDES-BENZ

1214						
1214 A	01.84 - 12.98	OM 366.913		3100.90.12 3164.20.00 3136.30.00 6901.40.00	310 10 MF310 310WGSZ KZI - 3	
1216						
LP 1216	06.69 -			3522.20.00	350 GF350KR	
				3502.30.00	350 10 350GSZ	
				6901.40.00	KZI - 3	
LP 1216	- 05.69			3502.30.00	350 10 350GSZ	
LP,LPK,LPS,LPKO 1216				3522.20.00	350 GF350KR	
				3502.30.00	350 10 350GSZ	
				6915.40.00	KZI - 4	
LP,LPKO 1216				3502.30.00	350 10 350GSZ	
1217						
1217				3300.20.00	330 GFM330	- From chassis no.: 4275670
				3300.30.00	330 10 330GSZ	- From chassis no.: 4275670
				6901.40.00	KZI - 3	- From chassis no.: 4275670
1217,1217 L	08.73 - 09.96	OM 353.950		3164.20.00	310 MF310	- To chassis no.: 4275669
1217 A	09.75 - 09.85	OM 353.951		3126.30.00	310 10 310GSBL	- To chassis no.: 4275669
1217 AK	09.75 - 09.85	OM 353.952		6901.40.00	KZI - 3	- To chassis no.: 4275669
1217 AS	09.75 - 09.85	OM 353.953		6901.40.00	KZI - 3	- From chassis no.: 4275670
1217 K	09.75 - 12.85	OM 353.970		3300.20.00	330 GFM330	- From chassis no.: 4275670
1217 S,1217 LS	08.73 - 09.96	OM 353.971		3300.30.00	330 10 330GSZ	- From chassis no.: 4275670
				6908.40.00	KZ - 3	- From model year: 06.1977
1217 CA	05.82 - 10.90	OM 366.960		3305.20.00	330 GMF330	
				3325.30.00	330 10 330WGSZ	
				6901.40.00	KZI - 3	
1217 KO, 124kW	09.75 - 09.85	OM 353.950 OM 353.951 OM 353.953		3164.20.00	310 MF310	- To chassis no.: 4275669
				3126.30.00	310 10 310GSBL	- To chassis no.: 4275669
				6901.40.00	KZI - 3	- To chassis no.: 4275669
				6901.40.00	KZI - 3	- From chassis no.: 4275670
				3300.20.00	330 GFM330	- From chassis no.: 4275670
				3300.30.00	330 10 330GSZ	- From chassis no.: 4275670
1217 KO, 125kW	03.94 - 12.98	OM 357.901 OM 357.918		3300.20.00	330 GFM330	
				3300.30.00	330 10 330GSZ	
				6901.40.00	KZI - 3	

Vehicle list



MERCEDES-BENZ

1219

1219	09.75 - 09.84	OM 401.905		3580.20.00	350 GMF350	
1219 K	09.75 - 09.84	OM 401.906		3583.30.00	350 10 350GSZ	
1219 S	09.75 - 09.84	OM 401.914 OM 401.915		8509.40.00	KZI - 4,5	
				3821.20.00	380 GF380KR	- Special design
				3821.30.00	380 10 380GSZ	- Special design
1219 A	09.75 - 12.82	OM 401.905		3580.20.00	350 GMF350	
1219 AK	09.75 - 12.84	OM 401.906		3583.30.00	350 10 350GSZ	
1219 F	09.75 - 09.84	OM 401.918		8509.40.00	KZI - 4,5	
1219 AF	09.75 - 09.84	OM 401.919		3580.20.00	350 GMF350	
				3583.30.00	350 10 350GSZ	
				8509.40.00	KZI - 4,5	
				3821.20.00	380 GF380KR	- Special design
				3821.30.00	380 10 380GSZ	- Special design

1222

1222, 159kW	07.82 - 02.90	OM 421.905 OM 421.909		3821.20.00	380 GF380KR	- To chassis no.: 5234953
				3821.30.00	380 10 380GSZ	- To chassis no.: 5234953
				8500.40.00	KZI - 4,5	- To chassis no.: 5234953
				8511.40.00	KZI - 4,5	- From chassis no.: 5095725
				4226.20.00	420 GF420KR	- From chassis no.: 5234954
				4234.20.00	420 GF420KR	- From chassis no.: 5234954
				4290.30.00	420 10 420GSZ	- From chassis no.: 5234954
1222, 160 - 165kW	07.89 - 08.94	OM 441.905		4300.90.18	430 10	
1222 A, 1222 LA	09.89 - 07.94	OM 441.913		4304.20.00	MFZ430	
1222 AF, 160 - 165kW	09.89 - 09.93	OM 441.914		4316.30.00	430WGTZ	
1222 F, 160 - 165kW	07.89 - 08.94	OM 441.915		8917.40.00	KZIZ - 5	
1222 S, 1222 LS	07.89 - 08.94	OM 441.917 OM 441.923 OM 441.925 OM 441.926				
1222 A	05.82 - 10.90	OM 421.905		3821.20.00	380 GF380KR	- To chassis no.: 5234953
1222 S	07.82 - 02.90	OM 421.909		3821.30.00	380 10 380GSZ	- To chassis no.: 5234953
				8500.40.00	KZI - 4,5	- To chassis no.: 5095724
				8511.40.00	KZI - 4,5	- From chassis no.: 5095725
				4226.20.00	420 GF420KR	- From chassis no.: 5234954
				4234.20.00	420 GF420KR	- From chassis no.: 5234954
				4290.30.00	420 10 420GSZ	- From chassis no.: 5234954

Vehicle list



MERCEDES-BENZ

1222

1222 AF, 159kW	05.82 - 12.91	OM 421.906	3821.20.00	380 GF380KR	
			3821.30.00	380 10 380GSZ	
			8500.40.00	KZI - 4,5	
1222 AS L 1222 1222 F, 159kW	05.82 - 12.91	OM 421.906	3821.20.00	380 GF380KR	- To chassis no.: 5234953
			3821.30.00	380 10 380GSZ	- To chassis no.: 5234953
			8500.40.00	KZI - 4,5	- To chassis no.: 5095724
			8511.40.00	KZI - 4,5	- Chassis no.: 5095725 - 5234953 - From chassis no.: 5234954
			4226.20.00	420 GF420KR	- From chassis no.: 5234954
			4234.20.00	420 GF420KR	- From chassis no.: 5234954
			4290.30.00	420 10 420GSZ	- From chassis no.: 5234954







1224

1224			4300.90.30	430 10 MFZ430	
			4305.20.00	430WGTZ	
			4304.30.00	KZIZ - 5	
			8917.40.00		
1224 AF, 170 - 177kW	02.93 - 09.96	OM 356.999 OM 357.946 OM 366.999	3583.20.00	350 GMF350	
			3583.30.00	350 10 350GSZ	- To chassis no.: K062599
			8529.40.00	KZI - 4,5	- To chassis no.: K062599 - From chassis no.: K062600
			3822.20.00	380 GF380KR	- From chassis no.: K062600
			3821.30.00	380 10 380GSZ	- From chassis no.: K062600
1224 AF, 180kW 1224 F	02.93 - 06.96	OM 356.999	4300.90.18	430 10 MFZ430	
			4304.20.00	430WGTZ	
	07.89 - 08.94	OM 401.984	4316.30.00	KZIZ - 5	
			8917.40.00		



































1225

1225 AF, 206kW	05.82 - 12.91	OM 422.913 OM 422.923	3821.20.00	380 GF380KR	
			3821.30.00	380 10 380GSZ	
			8500.40.00	KZI - 4,5	
			3831.20.00	380 GF380KR	
			8511.40.00	KZI - 4,5	
1225 AF, 213kW	05.82 - 12.91	OM 442.907	3831.20.00	380 GF380KR	
			3821.30.00	380 10 380GSZ	
			8511.40.00	KZI - 4,5	







Vehicle list

					
---	---	---	--	---	---





























MERCEDES-BENZ

1226						
1226 AF, 180 - 200kW	02.93 - 09.96	OM 401.973		4300.90.30	430 10	
1226 AF, 195 - 218kW	02.90 - 09.93	OM 401.978		4305.20.00	MFZ430	
1226 AF, 250kW	02.93 - 09.96	OM 401.984		4304.30.00	430WGTZ	
		OM 401.989		8917.40.00	KZIZ - 5	
		OM 441.989				
		OM 442.907				
		OM 442.914				
		OM 442.920				
		OM 442.926				
		OM 442.932				
		OM 442.933				
1227						
1227 A	01.92 - 07.92	OM 401.973		4300.90.18	430 10	
		OM 401.989		4304.20.00	MFZ430	
				4316.30.00	430WGTZ	
				8917.40.00	KZIZ - 5	
1227 AF, 1227 LAF	01.92 - 07.92	OM 445.933		4300.90.30	430 10	
				4305.20.00	MFZ430	
				4304.30.00	430WGTZ	
				8917.40.00	KZIZ - 5	
1228						
1228 F				3821.20.00	380	- To chassis no.: 5234953
				3821.30.00	380 10	- To chassis no.: 5234953
				8500.40.00	380GSZ	- To chassis no.: 5104252
				4234.20.00	KZI - 4,5	- To chassis no.: 5104252
				420	GF420KR	- From chassis no.: 5234954
				4226.20.00	420	- From chassis no.: 5234954
				4290.30.00	GF420KR	- From chassis no.: 5234954
				420 10	420GSZ	- From chassis no.: 5234954
				8511.40.00	KZI - 4.5	- Chassis no.: 5104253 - 5234953 - From chassis no.: 5234954
1231						
1231 AF	01.92 - 09.96	OM 401.986		4300.90.18	430 10	
				4304.20.00	MFZ430	
				4316.30.00	430WGTZ	
				8917.40.00	KZIZ - 5	
1234						
1234 AF	01.92 - 09.96	OM 441.989		4300.90.30	430 10	
		OM 441.993		4305.20.00	MFZ430	
		OM 445.923		4304.30.00	430WGTZ	
				8917.40.00	KZIZ - 5	
1313						
L,LA,LP 1313				3120.20.00	310	- From engine no.: 112293
				3124.30.00	GF310	- From engine no.: 112293
				310 10	310GSBL	- From engine no.: 112293
L,LA,LP 1313, 123kW				3122.20.00	310	
				3126.30.00	GF310	
					310GSBL	







Vehicle list

					
---	---	---	--	---	---















































MERCEDES-BENZ

1313					
L,LK,LS,LKO 1313		2953.20.00	295 GF295	- To chassis no.: 760271	
		2954.30.00	295 10 295BHZ	- To chassis no.: 760271	
		6909.40.00	KZI - 3	- To chassis no.: 760271	
		3120.20.00	310 GFX310	- Chassis no.: 760272 - 922885	
		3124.30.00	310 10 310GSBL	- From chassis no.: 760272	
		3101.20.00	310 GFX310	- From chassis no.: 922886	
LA,LAK,LAS 1313		2953.20.00	295 GF295	- To chassis no.: 760271 - Not for chassis no.: 500001 - 599999	
		2954.30.00	295 10 295BHZ	- To chassis no.: 760271 - Not for chassis no.: 500001 - 599999	
		3120.20.00	310 GFX310	- Chassis no.: 760272 - 922885 - Chassis no.: 500001 - 599999	
		3124.30.00	310 10 310GSBL	- From chassis no.: 760272 - Chassis no.: 500001 - 599999	
		3101.20.00	310 GFX310	- From chassis no.: 922886	
		6909.40.00	KZI - 3		
LF 1313		3122.20.00	310 GFX310	- To chassis no.: 922885	
		3119.20.00	310 GFX310	- From chassis no.: 922886	
		3126.30.00	310 10 310GSBL		
		6909.40.00	KZI - 3		
LP,LPK,LPKO 1313		3119.20.00	310 GFX310	- Special design	
		3126.30.00	310 10 310GSBL	- Special design	
		6909.40.00	KZI - 3	- Special design	
LP,LPK,LPS 1313		2953.20.00	295 GF295	- To chassis no.: 760271	
		2954.30.00	295 10 295BHZ	- To chassis no.: 760271	
		6909.40.00	KZI - 3	- To chassis no.: 922885 - Special design	
		3120.20.00	310 GFX310	- Chassis no.: 760272 - 922885	
		3124.30.00	310 10 310GSBL	- From chassis no.: 760272	
		3101.20.00	310 GFX310	- From chassis no.: 922886	
		3122.20.00	310 GFX310	- To chassis no.: 922885 - Special design	
		3119.20.00	310 GFX310	- From chassis no.: 922886 - Special design	
		3126.30.00	310 10 310GSBL	- Special design	

Vehicle list

					
---	---	---	--	---	---

MERCEDES-BENZ

1314						
1314	07.84 - 12.98	OM 356.909		3100.90.12	310 10	
1314 AK	06.87 - 12.98	OM 356.910		3164.20.00	MF310	
1314 K	07.84 - 12.98	OM 366.907		3136.30.00	310WGSZ	
		OM 366.914		6901.40.00	KZI - 3	
		OM 366.918		3300.90.04	330 10	- Equipment Var: SA24493-01
		OM 366.937		3300.20.00	GFM330	- Special design
				3325.30.00	330WGSZ	
				6901.40.00	KZI - 3	
1314 KO	07.84 - 12.98	OM 356.908		3300.90.04	330 10	
		OM 366.936		3300.20.00	GFM330	
				3325.30.00	330WGSZ	
				6901.40.00	KZI - 3	
				3500.90.11	350 10	- Equipment Var: SA33607-01
				3580.20.00	GMF350	
				3583.30.00	350GSZ	
				8529.40.00	KZI - 4,5	
				3300.20.00	330	- Equipment Var: SA24482-03
				3300.30.00	GFM330	
				3300.30.00	330 10	- Equipment Var: SA24482-03
				6907.40.00	330GSZ	
				6907.40.00	KZI - 3	- Equipment Var: SA24482-03
1317						
1317				3522.20.00	350	
				3502.30.00	GF350KR	
				3580.20.00	350 10	
				3583.30.00	350GSZ	
				8529.40.00	350	
				8529.40.00	GMF350	
				3583.30.00	350 10	
				8529.40.00	350GSZ	
				8529.40.00	KZI - 4,5	
1317				3305.20.00	330	
				3325.30.00	GMF330	
				6901.40.00	330 10	
				6901.40.00	330WGSZ	
				6901.40.00	KZI - 3	
1317,1317 L, 116 - 125kW	01.84 - 12.98	OM 356.944		3305.20.00	330	
1317 S,1317 LS	01.84 - 12.98	OM 357.902		3325.30.00	GMF330	
		OM 357.961		6901.40.00	330 10	
		OM 366.946		3580.20.00	330WGSZ	
		OM 366.953		3580.20.00	KZI - 3	
		OM 366.962		3580.20.00	350	- GBox: G4
				3517.30.00	GMF350	
				3517.30.00	350 10	- GBox: G4
				8529.40.00	350WGSZ	
				8529.40.00	KZI - 4,5	- GBox: G4
1317,1317 L, 125kW	03.96 - 12.98	OM 904.907		3620.90.01	362 18	
1317 K, 125kW, 4249cc	03.96 - 12.98			3606.20.00	MF362	
1317 KO, 125kW	03.96 - 12.98			3627.30.00	362WG TB	
1317 LS	03.96 - 12.98			8536.40.00	KZIS-4	
1317 AK	01.84 -			3100.90.12	310 10	
1317 K	01.84 -			3164.20.00	MF310	
				3136.30.00	310WGSZ	
				6901.40.00	KZI - 3	

Vehicle list



MERCEDES-BENZ

1317

1317 AK, 116 - 125kW 1317 AK, 155kW	08.84 - 12.98 12.92 - 12.98	OM 356.945	3505.20.00	350 G350KR	
		OM 356.995	3325.30.00	330 10 330WGSZ	
		OM 357.907 OM 366.944 OM 366.966	6901.40.00	KZI - 3	
1317 K, 5958cc	07.84 - 12.98	OM 357.902	3305.20.00	330 GMF330	
		OM 357.961	3325.30.00	330 10 330WGSZ	
		OM 366.962	6901.40.00	KZI - 3	
1317 KO 1317 KO, 116 - 125kW	03.94 - 12.98	OM 356.944	3300.90.04	330 10	
		OM 357.903	3300.20.00	GFM330	
		OM 357.962	3325.30.00	330WGSZ	
			6901.40.00	KZI - 3	
LP,LPK,LPS 1317			3522.20.00	350 GF350KR	
			3502.30.00	350 10 350GSZ	
LP,LPK,LPS,LPKO 1317			3522.20.00	350 GF350KR	
			3502.30.00	350 10 350GSZ	
			6915.40.00	KZI - 4	
LP,LPKO 1317			3502.30.00	350 10 350GSZ	

1319

LP,LPK,LPS,LPKO 1319			3522.20.00	350 GF350KR	
			3502.30.00	350 10 350GSZ	
			6915.40.00	KZI - 4	
LP,LPKO 1319			3502.30.00	350 10 350GSZ	
LP,LPS 1319			3522.20.00	350 GF350KR	
			3502.30.00	350 10 350GSZ	

1320

1320,1320 L, 125kW 1320,1320 L, 148 - 155kW	01.84 - 12.98 01.84 - 12.98	OM 356.992	3500.90.11	350 10	
		OM 357.921	3580.20.00	GMF350	
		OM 357.932	3583.30.00	350GSZ	
		OM 366.962	8529.40.00	KZI - 4,5	
		OM 366.966	3822.20.00	380 GF380KR	
		OM 366.980	3821.30.00	380 10 380GSZ	
		OM 366.988	8529.40.00	KZI - 4,5	
		OM 366.992			
		OM 366.997			
1320 AK	12.92 - 12.98	OM 356.995	3305.20.00	330 GMF330	
			3325.30.00	330 10 330WGSZ	
			6901.40.00	KZI - 3	
1320 L	12.92 - 12.98	OM 356.983	3500.90.11	350 10	
			3580.20.00	GMF350	
			3583.30.00	350GSZ	
			8529.40.00	KZI - 4,5	

Vehicle list

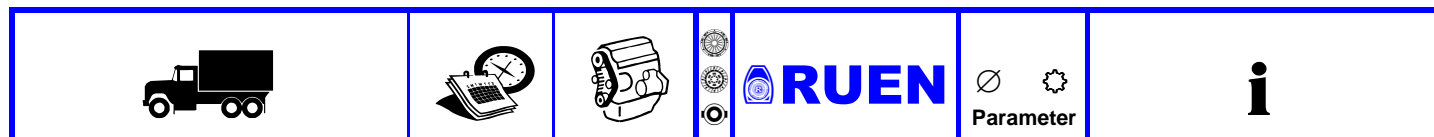

MERCEDES-BENZ

1320

1320 S, 1320 LS	01.84 - 12.98	OM 356.992		3500.90.11	350 10	
		OM 357.921		3580.20.00	GMF350	
		OM 357.932		3583.30.00	350GSZ	
		OM 366.980		8529.40.00	KZI - 4,5	
		OM 366.988		3822.20.00	380	GF380KR
		OM 366.992		3821.30.00	380 10	380GSZ
		OM 366.997		8529.40.00	KZI - 4,5	

1324

1324, 1324 L 1324 L 1324 S, 1324 LS	01.84 - 12.98	OM 356.983		3822.20.00	380	GF380KR
		OM 357.940		3821.30.00	380 10	380GSZ
	01.84 - 12.98	OM 357.948		8529.40.00	KZI - 4,5	
		OM 366.997				
		OM 366.999				

1413

1413 1413 A 1413 AK 1413 KO	09.75 - 12.84	OM 353.944		3164.20.00	310	MF310
		OM 353.946		3124.30.00	310 10	310GSBL
		OM 353.964		6908.40.00	KZ - 3	- To chassis no.: 469330
				6901.40.00	KZI - 3	- From chassis no.: 469331
1413 AKO 1413 K	09.75 - 12.84	OM 353.944		3164.20.00	310	MF310
		OM 353.946		3124.30.00	310 10	310GSBL
		OM 353.964		6901.40.00	KZI - 3	
L 1413				2813.20.00	280	HVB280
				2822.30.00	280 10	280GTZ
L, LA, LP 1413				2953.20.00	295	GF295
				2954.30.00	295 10	295BHZ
				6909.40.00	KZI - 3	

1414

1414	04.84 - 03.91	OM 366.906		3100.90.12	310 10	
		OM 366.909		3164.20.00	MF310	
				3136.30.00	310WGSZ	
1414 K	04.84 - 03.91	OM 366.906 OM 366.909		6901.40.00	KZI - 3	
				3164.20.00	310	MF310
				3126.30.00	310 10	310GSBL
				6907.40.00	KZI - 3	

1417

1417, 121 - 125kW	07.89 - 09.96	OM 356.940		3500.90.13	350 10	
		OM 356.943		3580.20.00	GMF350	
		OM 357.915		3517.30.00	350WGSZ	
		OM 366.952		8529.40.00	KZI - 4,5	

Vehicle list

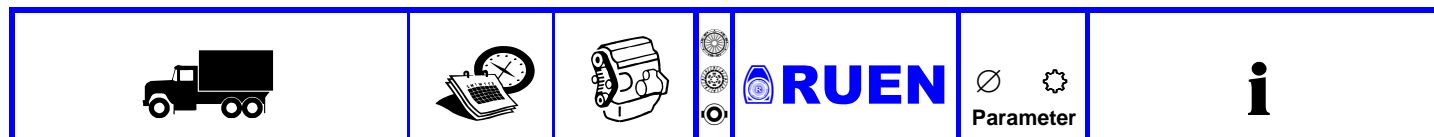

MERCEDES-BENZ

1417

1417, 124kW 1417 AKO 1417 KO	05.75 - 12.84	OM 353.951		3164.20.00	310 MF310	- To chassis no.: 4274598
	05.75 - 12.84	OM 353.953		3126.30.00	310 10 310GSBL	- To chassis no.: 4274598
	05.75 - 12.84	OM 353.971		6901.40.00	KZI - 3	- To chassis no.: 4274598 - From chassis no.: 4274599
				3300.20.00	330 GFM330	- From chassis no.: 4274599
				3300.30.00	330 10 330GSZ	- From chassis no.: 4274599
1417 A, 121 - 129kW	09.89 - 09.96	OM 356.943 OM 357.915 OM 366.952		3500.90.13 3580.20.00 3517.30.00 8529.40.00	350 10 GMF350 350WGSZ KZI - 4,5	
1417 A, 124kW 1417 AK, 124kW 1417 K, 124kW	05.75 - 12.84	OM 353.951		3164.20.00	310 MF310	- To chassis no.: 4274598
	05.75 - 12.84	OM 353.971		3126.30.00	310 10 310GSBL	- To chassis no.: 4274598
	05.75 - 12.84			6901.40.00	KZI - 3	- To chassis no.: 4274598 - From chassis no.: 4274599
				3300.20.00	330 GFM330	- From chassis no.: 4274599 - From model year: 06.1977
				3300.30.00	330 10 330GSZ	- From chassis no.: 4274599 - From model year: 06.1977
1417 AK, 121 - 129kW	09.89 - 09.96	OM 356.940 OM 356.943 OM 357.915 OM 366.952		3500.90.13 3580.20.00 3517.30.00 8529.40.00	350 10 GMF350 350WGSZ KZI - 4,5	
	04.84 - 03.91	OM 366.951 OM 366.952		3500.90.11 3580.20.00 3583.30.00 8529.40.00	350 10 GMF350 350GSZ KZI - 4,5	
				3580.20.00	350 GMF350	- Only install together
				3517.30.00	350 10 350WGSZ	- Only install together
				8529.40.00	KZI - 4,5	
1417 K, 121 - 125kW	07.89 - 09.96	OM 356.943 OM 357.915 OM 366.952		3500.90.13 3580.20.00 3517.30.00 8529.40.00	350 10 GMF350 350WGSZ KZI - 4,5	
				3502.30.00	350 10 350GSZ	
				3522.20.00	350 GF350KR	
LP 1417	06.69 -			3502.30.00	350 10 350GSZ	
				3502.30.00	350 10 350GSZ	
				6901.40.00	KZI - 3	

1418

L,LS,LK,LP,LPS 1418				3521.20.00	350 GF350KR	
				3502.30.00	350 10 350GSZ	

Vehicle list

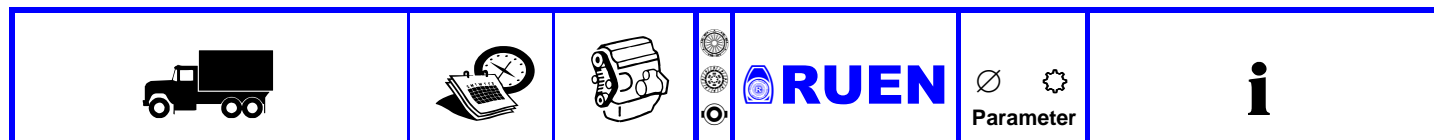

MERCEDES-BENZ

1419

1419,1419 L	08.73 - 09.96	OM 401.905		3580.20.00	350 GMF350	
1419 AK	05.75 - 12.84	OM 401.914		3583.30.00	350 10 350GSZ	
1419 AS	05.75 - 12.82	OM 401.919		8509.40.00	KZI - 4,5	
1419 F	05.75 - 12.82					
1419 K	05.75 - 12.82					
1419 S,1419 LS	08.73 - 09.96					
1419 C,1419 CL	08.73 - 09.96	OM 362.906 OM 362.909		3500.90.11 3580.20.00 3583.30.00 8529.40.00	350 10 GMF350 350GSZ KZI - 4,5	
				3580.20.00	350 GMF350	- Only install together
				3517.30.00	350 10 350WGSZ	- Only install together
				8529.40.00	KZI - 4,5	

1420

1420,1420 L, 155kW	12.87 - 09.96	OM 356.984		3500.90.11 3580.20.00 3583.30.00 8529.40.00	350 10 GMF350 350GSZ KZI - 4,5	
1420 LS, 155kW	02.90 - 09.96	OM 356.987				
1420,1420 L, 150kW	08.73 - 09.96	OM 366.983		3500.90.11 3580.20.00 3583.30.00 8529.40.00	350 10 GMF350 350GSZ KZI - 4,5	
				3580.20.00	350 GMF350	- Only install together
				3517.30.00	350 10 350WGSZ	- Only install together
				6901.40.00	KZI - 3	
1420 LS, 150kW	07.85 - 03.91	OM 366.983		3500.90.11 3580.20.00 3583.30.00 8529.40.00	350 10 GMF350 350GSZ KZI - 4,5	

1422

1422	02.93 - 08.94	OM 356.999		4300.90.18 4304.20.00 4316.30.00 8917.40.00	430 10 MFZ430 430WGTZ KZIZ - 5	
1422 F, 180 - 230kW	02.93 - 08.94	OM 401.973				
1422 F, 160 - 165kW	07.89 - 09.93	OM 401.975				
1422 LS	02.93 - 08.94	OM 401.977				
1422,1422 L, 160 - 165kW	12.87 - 09.96	OM 401.978				
1422 F, 177kW	03.93 - 08.94	OM 401.979				
1422 S,1422 LS, 160 - 165kW	12.87 - 09.96	OM 441.905 OM 441.913 OM 441.923 OM 441.925				
1422,1422 L, 159kW	08.73 - 09.96	OM 401.905		3821.20.00	380 GF380KR	- To chassis no.: 5234953
1422 F, 159kW	05.82 - 10.90	OM 421.905		3821.30.00	380 10 380GSZ	- To chassis no.: 5234953
1422 S,1422 LS, 159kW	08.73 - 09.96	OM 421.906		8500.40.00	KZI - 4,5	- To chassis no.: 5234953
				4226.20.00	420 GF420KR	- From chassis no.: 5234954
				4234.20.00	420 GF420KR	- From chassis no.: 5234954
				4290.30.00	420 10 420GSZ	- From chassis no.: 5234954
				8511.40.00	KZI - 4.5	- Chassis no.: 5095725 - 5234953 - From chassis no.: 5234954

Vehicle list



MERCEDES-BENZ

1424

1424,1424 L, 180 - 200kW, 9600cc	12.87 - 09.96	OM 401.973		4300.90.29	430 10	
1424 S,1424 LS, 180 - 200kW, 9600cc	12.87 - 09.96	OM 401.975		4305.20.00	MFZ430	
1424,1424 L, 180 - 200kW, 10960cc	12.87 - 09.96	OM 401.977		4346.30.00	430WGTZ	
1424 S,1424 LS, 180 - 200kW, 10960cc	12.87 - 09.96	OM 401.994		8905.40.00	KZIZ - 5	
		OM 445.924				
		OM 445.926				
		OM 445.938				
1424,1424 L, 176kW	08.73 - 09.96	OM 402.910		3821.20.00	380	
1424 F, 176kW	07.75 - 01.87	OM 402.911		3821.30.00	380 10	
1424 K	07.75 - 01.87	OM 402.919		8500.40.00	380GSZ	
1424 S,1424 LS, 176kW	08.73 - 09.96				KZI - 4,5	
1424 F				4300.90.18	430 10	
				4304.20.00	MFZ430	
				4316.30.00	430WGTZ	
				8917.40.00	KZIZ - 5	
LP 1424				3521.20.00	350	
LPS 1424				3502.30.00	350 10	
				3822.20.00	GF350KR	
				3822.30.00	380 10	
				8502.40.00	GF380KR	
					380GSZ	
					380 10	
					380GSZ	
					KZI - 4	

1425

1425				3821.20.00	380	- To chassis no.: 5234953
				3821.30.00	380 10	- To chassis no.: 5234953
				8500.40.00	380GSZ	- To chassis no.: 5234953
				8511.40.00	KZI - 4,5	- To chassis no.: 5234953
					KZI - 4,5	- Chassis no.: 5095725 - 5234953
1425 AF	08.73 - 09.96	OM 422.909		3821.20.00	380	
				3821.30.00	GF380KR	
				8500.40.00	380 10	
					380GSZ	
					KZI - 4,5	
1425 F				3821.20.00	380	- To chassis no.: 5234953
1425 L				3821.30.00	380 10	- To chassis no.: 5234953
				8500.40.00	380GSZ	- To chassis no.: 5104252
				4226.20.00	KZI - 4,5	- To chassis no.: 5104252
				4234.20.00	420	- From chassis no.: 5234954
				4290.30.00	GF420KR	- From chassis no.: 5234954
				4234.20.00	420	- From chassis no.: 5234954
				4290.30.00	GF420KR	- From chassis no.: 5234954
				4290.30.00	420 10	- From chassis no.: 5234954
				8511.40.00	420GSZ	- From chassis no.: 5234954
					KZI - 4,5	- Chassis no.: 5104253 - 5234953
					KZI - 4,5	- From chassis no.: 5234954
1425 S,1425 LS	08.73 - 09.96	OM 422.909		3831.20.00	380	
				3821.30.00	GF380KR	
				8500.40.00	380 10	- To chassis no.: 5104252
					380GSZ	- To chassis no.: 5104252
				8500.40.00	KZI - 4,5	- To chassis no.: 5104252
				8511.40.00	KZI - 4,5	- From chassis no.: 5104253

Vehicle list



MERCEDES-BENZ

1426

1426 S, 1426 LS	12.87 - 09.96	OM 442.914 OM 442.932	4300.90.30 4305.20.00 4304.30.00 8917.40.00	430 10 MFZ430 430WGTZ KZIZ - 5	
-----------------	---------------	--------------------------	--	--	--

1427

1427 1427 F, 200kW	02.93 - 09.96 02.93 - 09.96	OM 401.973 OM 401.985 OM 401.991	4300.90.29 4305.20.00 4346.30.00 8905.40.00	430 10 MFZ430 430WGTZ KZIZ - 5	
-----------------------	--------------------------------	--	--	--	--

1427 F			4300.90.30 4305.20.00 4304.30.00 8917.40.00	430 10 MFZ430 430WGTZ KZIZ - 5	
--------	--	--	--	--	--

1427 S, 1427 LS	02.93 - 09.96	OM 401.973	4300.90.30 4305.20.00 4304.30.00 8917.40.00	430 10 MFZ430 430WGTZ KZIZ - 5	
-----------------	---------------	------------	--	--	--

			4300.90.29 4305.20.00 4346.30.00 8905.40.00	430 10 MFZ430 430WGTZ KZIZ - 5	
--	--	--	--	--	--

1428

1428 AF			3821.20.00 3821.30.00 8500.40.00	380 GF380KR 380 10 380GSZ KZI - 4,5	
---------	--	--	---	---	--

1428 AF	08.73 - 09.96	OM 422.913	3831.20.00 3821.30.00 8511.40.00	380 GF380KR 380 10 380GSZ KZI - 4.5	
---------	---------------	------------	---	---	--

1428 F			3821.20.00 3821.30.00 8500.40.00 8511.40.00 4226.20.00 4234.20.00 4290.30.00	380 GF380KR 380 10 380GSZ KZI - 4,5 KZI - 4.5 420 GF420KR 420 GF420KR 420 10 420GSZ	- To chassis no.: 5234953 - To chassis no.: 5234953 - To chassis no.: 5104252 - Chassis no.: 5104253 - 5234953 - From chassis no.: 5234954 - From chassis no.: 5234954 - From chassis no.: 5234954 - From chassis no.: 5234954
--------	--	--	---	---	---







Vehicle list



































MERCEDES-BENZ

1428						
1428 F 615.064	05.82 - 12.91	OM 422.907 OM 422.913		3821.20.00	380 GF380KR	- To chassis no.: 5234953 - Engine code: OM421,422
				3897.30.00	380 10 380GSZ	- To chassis no.: 5234953 - Engine code: OM421,422
				8500.40.00	KZI - 4,5	- To chassis no.: 5104252 - Engine code: OM421,422
				8511.40.00	KZI - 4.5	- From chassis no.: 5104253 - To chassis no.: 5234953 - Engine code: OM421,422
				4234.20.00	420 GF420KR	- From chassis no.: 5234954 - Engine code: OM421,422
				4226.20.00	420 GF420KR	- From chassis no.: 5234954 - Engine code: OM421,422
				4290.30.00	420 10 420GSZ	- From chassis no.: 5234954 - Engine code: OM421,422
1429						
1429 AF 650.288	01.92 - 09.96	OM 442.926		4300.90.30	430 10	
				4305.20.00	MFZ430	
				4304.30.00	430WGTZ	
				8917.40.00	KZIZ - 5	
1429 AF 615.266	08.73 - 09.96	OM 442.907		4300.90.30	430 10	- Engine code: OM442
				4305.20.00	MFZ430	
				4304.30.00	430WGTZ	
				8917.40.00	KZIZ - 5	
1431						
1431	12.87 - 08.96	OM 401.979		4300.90.30	430 10	
	12.87 - 08.96	OM 442.907		4305.20.00	MFZ430	
1431 F	12.87 - 08.96			4304.30.00	430WGTZ	
				8917.40.00	KZIZ - 5	
1431 S				4300.90.29	430 10	
				4305.20.00	MFZ430	
				4346.30.00	430WGTZ	
				8905.40.00	KZIZ - 5	
1513						
L,LA,LB,LP 1513				3120.20.00	310 GFX310	
LPS,LPK 1513				3124.30.00	310 10 310GSBL	
L,LA,LK,LS 1513				3101.20.00	310 GFX310	
LAK,LKO,LAKO 1513				3126.30.00	310 10 310GSBL	
				3124.30.00	310 10 310GSBL	
				6909.40.00	KZI - 3	
LP,LPK,LPS 1513				3120.20.00	310 GFX310	- To chassis no.: 922885 - Special design
				3101.20.00	310 GFX310	- From chassis no.: 922886
				3124.30.00	310 10 310GSBL	
				6909.40.00	KZI - 3	- To chassis no.: 922885 - From chassis no.: 922886 - Special design
				3126.30.00	310 10 310GSBL	- To chassis no.: 922885 - From chassis no.: 922886 - Special design
				3119.20.00	310 GFX310	- From chassis no.: 922886 - Special design

Vehicle list

					
---	---	---	--	---	---

MERCEDES-BENZ

1514					
1514,1514 L	01.84 - 12.98	OM 356.908		3100.90.12	310 10
1514 K	01.89 - 12.98	OM 366.936		3164.20.00	MF310
				3136.30.00	310WGSZ
				6901.40.00	KZI - 3
1517					
1517,1517 L, 116 - 125kW	01.84 - 12.98	OM 356.946		3305.20.00	330
		OM 356.953			GMF330
		OM 357.903		3325.30.00	330 10
		OM 357.962			330WGSZ
		OM 357.963		6901.40.00	KZI - 3
		OM 366.945			
		OM 366.979			
1517,1517 L, 125kW	03.96 - 12.98	OM 904.907		3620.90.01	362 18
1517 K, 125kW	03.96 - 12.98			3606.20.00	MF362
				3627.30.00	362WGTB
				8536.40.00	KZIS-4
1517 K	01.89 - 12.98	OM 356.946		3580.20.00	350
		OM 356.953			GMF350
		OM 357.903		3517.30.00	350 10
		OM 357.963			350WGSZ
		OM 366.945		8529.40.00	KZI - 4,5
		OM 366.979			
L,LA,LK,LP,LS 1517				3522.20.00	350
LAK,LAS,LPK,LPS 1517				3502.30.00	GF350KR
				6915.40.00	350 10
					350GSZ
LP 1517				3502.30.00	350 10
LPKO 1517					350GSZ
1518					
LA 1518				3521.20.00	350
LAK 1518				3552.30.00	GF350KR
				3502.30.00	350 10
					350
LP 1518				3521.20.00	350
				3502.30.00	GF350KR
					350 10
					350GSZ
1519					
L,LA,LK,LP,LS 1519				3522.20.00	350
LAK,LAS,LPK,LPS 1519				3502.30.00	GF350KR
				6915.40.00	350 10
					350GSZ
LP 1519				3502.30.00	350 10
LPKO 1519					350GSZ
1520					
1520,1520 L	01.84 - 12.98	OM 356.990		3580.20.00	350
		OM 357.922			GMF350
		OM 357.930		3583.30.00	350 10
		OM 366.995			350GSZ
				8529.40.00	KZI - 4,5
				3822.20.00	380
					GF380KR
				3821.30.00	380 10
					380GSZ

Vehicle list



MERCEDES-BENZ

1524

1524,1524 L	01.84 - 12.98	OM 356.999 OM 357.941 OM 357.947 OM 366.999	3822.20.00	380 GF380KR	
			3821.30.00	380 10 380GSZ	
			8529.40.00	KZI - 4,5	

1613

1613,1613 L	08.73 - 09.96	OM 353.944 OM 353.946	3164.20.00	310 MF310	
			3124.30.00	310 10 310GSBL	
			6908.40.00	KZ - 3	- To chassis no.: 4696330
			6901.40.00	KZI - 3	- From chassis no.: 4696331
1613 K	01.75 - 12.84	OM 353.944 OM 353.946	3164.20.00	310 MF310	
			3124.30.00	310 10 310GSBL	
			6908.40.00	KZ - 3	- To chassis no.: 4188089 - To chassis no.: 4696330
			6901.40.00	KZI - 3	- From chassis no.: 4188090 - From chassis no.: 4696331
1613 KO	01.75 - 12.84	OM 353.944 OM 353.946	3164.20.00	310 MF310	
			3124.30.00	310 10 310GSBL	
			6908.40.00	KZ - 3	- To chassis no.: 4188089
			6901.40.00	KZI - 3	- From chassis no.: 4188090

1614

1614	04.84 - 03.91	OM 366.906	3100.90.12	310 10 MF310 310WGSZ KZI - 3	
			3164.20.00		
			3136.30.00		
			6901.40.00		
1614 K	04.84 - 03.91	OM 366.909	3164.20.00	310 MF310	
			3126.30.00	310 10 310GSBL	
			6907.40.00	KZI - 3	

1617

1617,1617 L	08.73 - 09.96	OM 353.951 OM 353.953	3164.20.00	310 MF310	- To chassis no.: 4188089
			3126.30.00	310 10 310GSBL	- To chassis no.: 4188089
			6908.40.00	KZ - 3	- To chassis no.: 4188089
			3300.20.00	330 GFM330	- From chassis no.: 4188090
			3300.30.00	330 10 330GSZ	- From chassis no.: 4188090
			6901.40.00	KZI - 3	- From chassis no.: 4188090
1617 A,AKO,K,KO			3164.20.00	310 MF310	
			3126.30.00	310 10 310GSBL	
			6901.40.00	KZI - 3	

Vehicle list

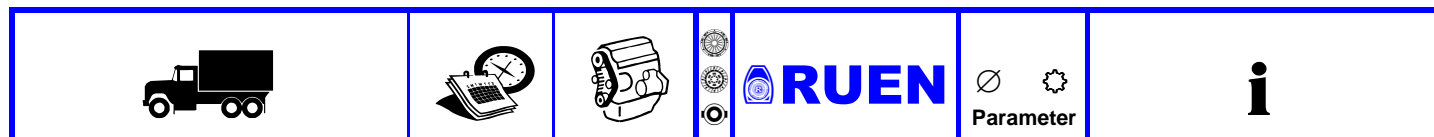

MERCEDES-BENZ

1617

1617 AK 1617 K	01.75 - 07.85 01.75 - 07.85	OM 353.951 OM 353.953 OM 353.971	3164.20.00	310 MF310	- To chassis no.: 4276220
			3126.30.00	310 10 310GSBL	- To chassis no.: 4276220
			6908.40.00	KZ - 3	- To chassis no.: 4276220 - From model year: 06.1977
			3300.20.00	330 GFM330	- From chassis no.: 4276221 - From model year: 06.1977
			3300.30.00	330 10 330GSZ	- From chassis no.: 4276221 - From model year: 06.1977
			6901.40.00	KZI - 3	- From chassis no.: 4276221
1617 C,1617 CL 1617 CAK 1617 CK 1617 CS	08.73 - 09.96 04.84 - 03.91 04.84 - 03.91 04.84 - 03.91	OM 366.951 OM 366.952	3500.90.11	350 10 GMF350	
			3580.20.00	350GSZ	
			3583.30.00	KZI - 4,5	
			8529.40.00		
			3580.20.00	350 GMF350	- Only install together
			3517.30.00	350 10 350WGSZ	- Only install together
			8529.40.00	KZI - 4,5	
1617 KO 1617 S	01.75 - 07.85 01.75 - 07.85	OM 353.951 OM 353.953	3164.20.00	310 MF310	- To chassis no.: 4188089
			3126.30.00	310 10 310GSBL	- To chassis no.: 4188089
			6908.40.00	KZ - 3	- To chassis no.: 4188089
			3300.20.00	330 GFM330	- From chassis no.: 4188090
			3300.30.00	330 10 330GSZ	- From chassis no.: 4188090
			6901.40.00	KZI - 3	- From chassis no.: 4188090
LP,LPKO 1617			3522.20.00	350 GF350KR	
			3502.30.00	350 10 350GSZ	
			6915.40.00	KZI - 4	
LP 1617			3502.30.00	350 10 350GSZ	

1618

1618			3822.20.00	380 GF380KR	
			3822.30.00	380 10 380GSZ	
L 1618 LK 1618 LS 1618			3521.20.00	350 GF350KR	
			3522.30.00	350 10 350GSZ	

1619

1619			3822.20.00	380 GF380KR	
			3822.30.00	380 10 380GSZ	

Vehicle list



MERCEDES-BENZ







1619

1619,1619 L 1619 K 1619 KO	08.73 - 09.96 11.74 - 12.82 11.74 - 01.87	OM 401.905 OM 401.914	3580.20.00	350 GMF350	
			3583.30.00	350 10 350GSZ	
			8509.40.00	KZI - 4,5	
			3821.20.00	380 GF380KR	
			3821.30.00	380 10 380GSZ	
			8500.40.00	KZI - 4,5	
1619 AK	11.74 - 12.82	OM 401.905	3580.20.00	350 GMF350	
			3583.30.00	350 10 350GSZ	
			8509.40.00	KZI - 4,5	
1619 C,1619 CL	08.73 - 09.96	OM 362.906 OM 362.909	3500.90.11	350 10 GMF350	
			3580.20.00	350GSZ	
			3583.30.00	KZI - 4,5	
			3580.20.00	350 GMF350	- Only install together
			3517.30.00	350 10 350WGSZ	- Only install together
			8529.40.00	KZI - 4,5	
1619 S	11.74 - 12.84	OM 401.905 OM 401.914	3580.20.00	350 GMF350	
			3583.20.00	350 GMF350	
			8509.40.00	KZI - 4,5	
			3821.20.00	380 GF380KR	
			3821.30.00	380 10 380GSZ	
			8500.40.00	KZI - 4,5	
LP 1619 LPKO 1619			3522.20.00	350 GF350KR	
			3502.30.00	350 10 350GSZ	
			6915.40.00	KZI - 4	
LP 1619			3502.30.00	350 10 350GSZ	































1620

1620,1620 L	08.73 - 09.96	OM 366.983	3500.90.11	350 10 GMF350	
			3580.20.00	350GSZ	
			3583.30.00	KZI - 4,5	
			3580.20.00	350 GMF350	- Only install together
			3517.30.00	350 10 350WGSZ	- Only install together
			8529.40.00	KZI - 4,5	
L 1620 LK 1620 LPS 1620 LS 1620	09.65 - 09.65 - 09.65 - 09.65 -		3822.20.00	380 GF380KR	- GBox: AK 6-80
			3822.30.00	380 10 380GSZ	- GBox: AK 6-80
			8502.40.00	KZI - 4	- GBox: AK 6-80

Vehicle list

					
---	---	---	--	---	---

MERCEDES-BENZ

1620						
L 1620	- 08.65			3822.20.00	380 GF380KR	- GBox: AK 6-7
LP 1620	- 08.65					
1621						
1621				3521.20.00	350 GF350KR	
				3552.30.00	350 10 350	
				3822.20.00	380 GF380KR	
				3822.30.00	380 10 380GSZ	
				8502.40.00	KZI - 4	
L 1621				3822.20.00	380 GF380KR	
LK 1621				3822.30.00	380 10 380GSZ	
LS 1621				8502.40.00	KZI - 4	
1622						
1622,1622 L	08.73 - 09.96	OM 421.905		3821.20.00	380 GF380KR	- To chassis no.: 234953
1622 AK	05.82 - 10.89	OM 441.906		3821.30.00	380 10 380GSZ	- To chassis no.: 234953
1622 K	05.82 - 10.89	OM 441.907		8500.40.00	KZI - 4,5	- To chassis no.: 234953 - From chassis no.: 234954
1622 S	05.82 - 03.91			4226.20.00	420 GF420KR	- From chassis no.: 234954
				4234.30.00	420 10 420/210GSZ	- From chassis no.: 234954
				4290.30.00	420 10 420GSZ	- From chassis no.: 234954
				4289.30.00	420 10 420GSZ	- For PTO
1623						
1623 K,L,S,AK,AS,LS				4200.90.16	420 10 GF420KR	
				4235.20.00	GF420KR	
				4257.30.00	420GSZ	
				8500.40.00	KZI - 4,5	
				4225.20.00	420 GF420KR	
L 1623				3822.20.00	380 GF380KR	
LA 1623				3822.30.00	380 10 380GSZ	
LP 1623						
1624						
1624				3822.20.00	380 GF380KR	
				3822.30.00	380 10 380GSZ	
				8502.40.00	KZI - 4	
1624,1624 L	08.73 - 09.96	OM 402.911 OM 402.923		3821.20.00	380 GF380KR	
				3821.30.00	380 10 380GSZ	
				8500.40.00	KZI - 4,5	
				4289.30.00	420 10 420GSZ	- For PTO

Vehicle list



MERCEDES-BENZ

1624

1624 K 1624 S,1624 LS	07.75 - 08.82	OM 402.910		3821.20.00	380 GF380KR	
	08.73 - 09.96	OM 402.911		3821.30.00	380 10 380GSZ	
				8500.40.00	KZI - 4,5	
L 1624 LA 1624 LAK 1624 LAS 1624 LK 1624 LP 1624 LPK 1624 LPS 1624 LS 1624				3822.20.00	380 GF380KR	
				3822.30.00	380 10 380GSZ	
				8502.40.00	KZI - 4	







1625

1625,1625 L	08.73 - 09.96	OM 422.909		3831.20.00	380 GF380KR	
				3821.30.00	380 10 380GSZ	
				8500.40.00	KZI - 4,5	- To chassis no.: 5107148
				8511.40.00	KZI - 4.5	- From chassis no.: 5107149
				4200.90.16	420 10 GF420KR	- Special design
				4235.20.00	420GSZ	
				4257.30.00	420GSZ	
				8500.40.00	KZI - 4,5	
1625 AK	10.80 - 11.89	OM 422.909		3831.20.00	380 GF380KR	
				3821.30.00	380 10 380GSZ	
				8511.40.00	KZI - 4.5	
1625 K	05.80 - 11.89	OM 422.909		3831.20.00	380 GF380KR	
				3821.30.00	380 10 380GSZ	
				8500.40.00	KZI - 4,5	
1625 S,1625 LS	08.73 - 09.96	OM 422.909		3831.20.00	380 GF380KR	
				3821.30.00	380 10 380GSZ	
				8500.40.00	KZI - 4,5	- To chassis no.: 5107148
				8511.40.00	KZI - 4.5	- From chassis no.: 5107149







































1626

1626,1626 L 1626 AS 1626 S,1626 LS	08.73 - 09.96	OM 402.906		3821.20.00	380 GF380KR	
	05.74 - 12.80	OM 402.912		3821.30.00	380 10 380GSZ	
	08.73 - 09.96	OM 402.916		8500.40.00	KZI - 4,5	
1626 AK 1626 K	08.73 - 12.80	OM 402.906		3821.20.00	380 GF380KR	
	08.73 - 12.80			3821.30.00	380 10 380GSZ	
				8500.40.00	KZI - 4,5	
				4289.30.00	420 10 420GSZ	- For PTO

Vehicle list

					
---	---	---	--	---	---

MERCEDES-BENZ

1626						
LP 1626				3822.20.00	380 GF380KR	
LPK 1626				3822.30.00	380 10 380GSZ	
LPS 1626						
1627						
1627 AF	01.92 - 09.96	OM 442.914 OM 442.920 OM 442.932 OM 442.933		4300.90.30  4305.20.00  4304.30.00  8917.40.00	430 10 MFZ430 430WGTZ KZIZ - 5	
1628						
1628,1628 L	08.73 - 09.96	OM 422.905 OM 422.906 OM 422.911 OM 422.913		3831.20.00	380 GF380KR	
				3821.30.00	380 10 380GSZ	
				8511.40.00	KZI - 4,5	
				4200.90.16  4235.20.00  4257.30.00  8500.40.00	420 10 GF420KR 420GSZ KZI - 4,5	
				4225.20.00	420 GF420KR	
				4244.20.00	420 GFX420KR	- Special design
				4266.30.00	420 10 420/210GSZ	- Special design
				8513.40.00	KZI - 4,5	- Special design
1628 A	01.80 - 05.89	OM 422.905 OM 422.906 OM 422.911		4200.90.16  4235.20.00  4257.30.00  8500.40.00	420 10 GF420KR 420GSZ KZI - 4,5	
				4225.20.00	420 GF420KR	
				4298.30.00	420 10 420GSZ	- For PTO
1628 S,1628 LS	08.73 - 09.96	OM 422.905 OM 422.906 OM 422.911		4200.90.16  4235.20.00  4257.30.00  8500.40.00	420 10 GF420KR 420GSZ KZI - 4,5	
				4225.20.00	420 GF420KR	
1632						
1632,1632 L 1632 AS	08.73 - 09.96	OM 403.916		4200.90.16  4235.20.00  4257.30.00  8500.40.00	420 10 GF420KR 420GSZ KZI - 4,5	
	05.74 - 09.83	OM 403.931 OM 403.932		4225.20.00	420 GF420KR	
1632 AK 1632 K	08.73 - 08.82	OM 403.916		4200.90.16  4235.20.00  4257.30.00  8500.40.00	420 10 GF420KR 420GSZ KZI - 4,5	
	08.73 - 08.82			4225.20.00	420 GF420KR	
					4298.30.00	420 10 420GSZ

Vehicle list



MERCEDES-BENZ

1632

1632 S,1632 LS	08.73 - 09.96	OM 403.916 OM 403.931 OM 403.932	4200.90.16	420 10	
			4235.20.00	GF420KR	
			4257.30.00	420GSZ	
			8500.40.00	KZI - 4,5	
			4225.20.00	420	
				GF420KR	
			3857.10.00	380	- From model year: 01.1980 - For: Turbo - This part number includes one clutch disc
	GF2/380				
	3892.30.00	380 10	- Loose clutch disc - For: Turbo		
		380GSZ			
	8520.40.00	KZI - 4,5	- For: Turbo		
	3857.20.00	380	- For: Turbo		
		G380KR			
	3857.50.00	380			
		GF2/380			
LAPK 1632			4250.20.00	420	
				GFX420KR	
LP 1632	01.80 -		3857.10.00	380	- This part number includes one clutch disc
				GF2/380	
			3892.30.00	380 10	- Loose clutch disc
				380GSZ	
			8520.40.00	KZI - 4,5	
	3857.20.00	380			
		G380KR			
	3857.50.00	380			
		GF2/380			
LP 1632 LPK 1632 LPS 1632			4250.20.00	420	
				GFX420KR	
			4235.20.00	420	
			4231.30.00	420 10	
				420GSZ	







1633

1633,1633 L	08.73 - 09.96	OM 422.952 OM 422.954 OM 422.956 OM 422.957 OM 422.958	4244.20.00	420	- Special design
				GFX420KR	
			4266.30.00	420 10	- Special design
				420/210GSZ	
	8513.40.00	KZI - 4.5	- Special design		
	4287.30.00	420 10	- For PTO		
		420GVZ			
1633 S,1633 LS	08.73 - 09.96	OM 422.952 OM 422.954 OM 422.956 OM 422.957 OM 422.958	4244.20.00	420	
				GFX420KR	
			4266.30.00	420 10	
				420/210GSZ	
	8513.40.00	KZI - 4.5			
	4287.30.00	420 10	- For PTO		
		420GVZ			































1635

1635,1635 L 1635 K	08.73 - 09.96	OM 442.950	3882.10.00	380	- This part number includes one clutch disc
				GF2/380	
			3855.30.00	380 10	- Loose clutch disc
		380GS			
	02.86 - 07.89	OM 442.952	8520.40.00	KZI - 4,5	
			3882.20.00	380	- Contained in xxxx.10.00
			GF2/380		
	3882.50.00	380	- Contained in xxxx.10.00		
		GF2/380			
	3883.30.00	380 10	- Contained in xxxx.10.00		
		380GSZ			

Vehicle list

					
---	---	---	--	---	---

MERCEDES-BENZ

1635						
1635 S,1635 LS	08.73 - 09.96	OM 442.950 OM 442.952	 3882.10.00	380 GF2/380	- This part number includes one clutch disc	
			 3855.30.00	380 10 380GS	- Loose clutch disc	
			 8520.40.00	KZI - 4,5		
			 3882.20.00	380 GF2/380	- Contained in xxxx.10.00	
			 3882.50.00	380 GF2/380	- Contained in xxxx.10.00	
			 3883.30.00	380 10 380GSZ	- Contained in xxxx.10.00	
1636						
1636,1636 L	08.73 - 09.96	OM 423.905 OM 423.908	 4244.20.00	420 GFX420KR		
			 4266.30.00	420 10 420/210GSZ		
			 8513.40.00	KZI - 4.5		
1636 S,1636 LS	08.73 - 09.96	OM 423.905 OM 423.908	 4244.20.00	420 GFX420KR	- Special design	
			 4266.30.00	420 10 420/210GSZ	- Special design	
			 8514.40.00	KZI - 4,5	- Special design	
1638						
1638 1638 S,1638 LS	11.80 - 12.86 08.73 - 09.96	OM 422.953 OM 422.955 OM 422.959	 3857.10.00	380 GF2/380	- This part number includes one clutch disc	
			 3892.30.00	380 10 380GSZ	- Loose clutch disc	
			 8520.40.00	KZI - 4,5		
			 3857.20.00	380 G380KR	- Contained in xxxx.10.00	
			 3857.50.00	380 GF2/380	- Contained in xxxx.10.00	
1644						
1644 1644 S,1644 LS	06.86 - 08.89 08.73 - 09.96	OM 442.951 OM 442.953 OM 442.980	 3887.10.00	380 GF2/380	- This part number includes one clutch disc	
			 3891.30.00	380 10 380GS	- Loose clutch disc	
			 8520.40.00	KZI - 4,5		
			 3882.20.00	380 GF2/380	- Contained in xxxx.10.00	
			 3882.50.00	380 GF2/380	- Contained in xxxx.10.00	
			 3889.30.00	380 10 380GSZ	- Contained in xxxx.10.00	
1717						
1717,1717 L	12.87 - 09.96	OM 356.940 OM 366.952	 3500.90.13	350 10		
			 3580.20.00	GMF350		
			 3517.30.00	350WGSZ		
			 8529.40.00	KZI - 4,5		
			 3822.20.00	380 GF380KR	- Special design	
			 3888.30.00	380 10 380WGSZ	- Special design	
 8529.40.00	KZI - 4,5	- Special design				

Vehicle list



MERCEDES-BENZ

1717

1717 AK	09.89 - 08.94	OM 356.940 OM 366.952		3500.90.11	350 10	
				3580.20.00	GMF350	
				3583.30.00	350GSZ	
				8529.40.00	KZI - 4,5	
				3500.90.13	350 10	
	3580.20.00	GMF350				
	3517.30.00	350WGSZ				
	8529.40.00	KZI - 4,5				
				3822.20.00	380	GF380KR - Special design
				3888.30.00	380 10	380WGSZ - Special design
				8529.40.00	KZI - 4,5	- Special design
1717 K	09.89 - 08.94	OM 356.940 OM 366.952		3500.90.13	350 10	
				3580.20.00	GMF350	
				3517.30.00	350WGSZ	
				8529.40.00	KZI - 4,5	
				3822.20.00	380	GF380KR - Special design
	3888.30.00	380 10	380WGSZ - Special design			
	8529.40.00	KZI - 4,5	- Special design			

1719

1719 1719 K	09.73 - 08.82	OM 401.909 OM 401.916		3827.20.00	380	GF380KR
				3821.30.00	380 10	380GSZ - Special design
				8500.40.00	KZI - 4,5	- Special design
				3821.20.00	380	GF380KR - Special design
				3871.30.00	380 10	380/70GSZ - For PTO
1719 AK 1719 S	09.73 - 08.82	OM 401.909 OM 401.916		3827.20.00	380	GF380KR
				3821.30.00	380 10	380GSZ - Special design
				8500.40.00	KZI - 4,5	- Special design
				3821.20.00	380	GF380KR

1720

1720 677.024, 677.026, 677.022	01.84 - 12.98	OM 357.922 OM 366.995		3580.20.00	350	GMF350
				3583.30.00	350 10	350GSZ
				8529.40.00	KZI - 4,5	
1720, 1720 L 652.025, 652.027, 652.429, 652.436, 652.020, 652.023, 652.028, 652.029, 699.001, 652.428, 652.024	12.87 - 09.96	OM 356.984 OM 356.985 OM 366.983		3500.90.11	350 10	
				3580.20.00	GMF350	
				3583.30.00	350GSZ	
				8529.40.00	KZI - 4,5	
				3822.20.00	380	GF380KR
	3888.30.00	380 10	380WGSZ			
	8529.40.00	KZI - 4,5				

Vehicle list

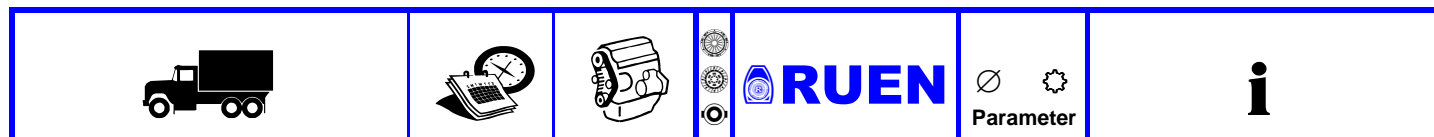

MERCEDES-BENZ

1720

1720 S 652.121	02.90 - 08.94	OM 356.984	3500.90.11 3580.20.00 3583.30.00 8529.40.00	350 10 GMF350 350GSZ KZI - 4,5	
1720 L 652.436	12.88 - 08.94	OM 441.916 OM 441.920 OM 441.932	4300.90.18 4304.20.00 4316.30.00 8917.40.00	430 10 MFZ430 430WGTZ KZIZ - 5	

1722

1722, 218kW 1722 AK, 177kW 1722 AK, 200kW 1722 K, 230kW 1722 L	12.88 - 08.94 12.88 - 08.94 12.88 - 08.94 12.88 - 08.94 12.88 - 08.94	OM 356.999 OM 366.983 OM 401.973 OM 401.978 OM 401.979 OM 442.907	4300.90.18 4304.20.00 4316.30.00 8917.40.00	430 10 MFZ430 430WGTZ KZIZ - 5	
1722, 153kW 1722, 1722 L, 1722 LL, 151 - 165kW 1722, 1722 L, 1722 LL, 160 - 165kW 1722 AK, 151 - 165kW 1722 K, 153 - 165kW 1722 S	08.88 - 08.94 12.87 - 09.96 08.88 - 08.94 12.88 - 08.94 12.88 - 08.94 12.88 - 08.94	OM 441.905 OM 441.913 OM 441.914 OM 441.916 OM 441.920 OM 441.923 OM 441.926 OM 441.932 OM 441.933	4305.20.00 8917.40.00 4300.90.18 4304.20.00 4316.30.00 8917.40.00	430 MFZ430 KZIZ - 5 430 10 MFZ430 430WGTZ KZIZ - 5	- To chassis no.: 563495 - To chassis no.: 563495 - From chassis no.: 563495

1724

1723, 1724	01.84 - 12.98	OM 366.999	3822.20.00 3821.30.00 8529.40.00	380 GF380KR 380 10 380GSZ KZI - 4,5	
------------	---------------	------------	---	---	--

1726

1726, 1726 L, 1726 LL 1726 AK 1726 S, 1726 LS 1726 K	12.87 - 09.96 06.89 - 08.94 12.87 - 09.96 12.88 - 08.94	OM 440.909 OM 442.906 OM 442.907 OM 442.909 OM 442.914 OM 442.922 OM 442.923 OM 442.932 OM 442.935	4300.90.30 4305.20.00 4304.30.00 8917.40.00	430 10 MFZ430 430WGTZ KZIZ - 5	
1726 L, 1726 LL 1727 L 1726 LL	12.88 - 08.94 12.88 - 08.94 12.87 - 09.96	OM 401.973 OM 401.978 OM 441.960	4300.90.30 4305.20.00 4304.30.00 8917.40.00	430 10 MFZ430 430WGTZ KZIZ - 5	



































1727

1727 L	12.88 - 08.94	OM 401.973 OM 401.978	4300.90.30 4305.20.00 4304.30.00 8917.40.00 4244.30.00 9302.40.00	430 10 MFZ430 430WGTZ KZIZ - 5 420 10 420/210GSZ KZI-6	- For PTO - For PTO
--------	---------------	--------------------------	---	--	------------------------

Vehicle list

					
---	---	---	--	---	---

MERCEDES-BENZ

1729						
1728, 1729, 1729 L 1729 K 1729 S, 1729 LS	07.87 - 09.96 07.88 - 08.94 07.87 - 09.96	OM 442.906 OM 442.907 OM 442.908 OM 442.923 OM 442.925	   	4300.90.30 4305.20.00 4304.30.00 8917.40.00	430 10 MFZ430 430WGTZ KZIZ - 5	
			   	4300.90.29 4305.20.00 4346.30.00 8905.40.00	430 10 MFZ430 430WGTZ KZIZ - 5	
			   	4300.90.28 4305.20.00 4346.30.00 8905.40.00	430 10 MFZ430 430WGTZ KZIZ - 5	- Engine code: OM442
1729 AK	07.88 - 09.93	OM 442.907 OM 442.926	   	4300.90.30 4305.20.00 4304.30.00 8917.40.00	430 10 MFZ430 430WGTZ KZIZ - 5	
1729 652.043, 652.046, 652.045	12.87 - 09.96	OM 442.906 OM 442.907 OM 442.923	   	3891.30.00 9302.40.00 3854.30.00 4244.30.00	380 10 380GS KZI-6 380 10 380GVZ 420 10 420/210GSZ	- Engine code: OM442 - Loose clutch disc - Engine code: OM442 - Engine code: OM442
1729 652.045-047, 652.541, 652.043, 652.142, 652.346, 652.542, 652.446-448, 652.141 1729 LS 652.542	12.87 - 09.96	OM 442.907	  	3891.30.00 9302.40.00 3854.30.00	380 10 380GS KZI-6 380 10 380GVZ	- Engine code: OM442 - Loose clutch disc - Engine code: OM442
1733						
1733, 1733 L, 1734 L 1733 S, 1733 LS	12.87 - 09.96 12.87 - 09.96	OM 441.960 OM 441.962 OM 441.981 OM 441.983 OM 441.986 OM 441.989 OM 445.920 OM 445.939	   	4300.90.01 4304.20.00 4346.30.00 8905.40.00	430 10 MFZ430 430WGTZ KZIZ - 5	
1735						
1735, 1735 L 1735 AK 1735 K 1735 L 1735 S, 1735 LS	07.87 - 09.96 08.89 - 08.94 07.88 - 08.94 07.88 - 08.94 07.87 - 09.96	OM 440.940 OM 442.906 OM 442.942 OM 442.944 OM 442.963 OM 442.964 OM 442.966 OM 442.976	   	4300.90.01 4304.20.00 4346.30.00 8905.40.00	430 10 MFZ430 430WGTZ KZIZ - 5	
1735 ,AF			  	4300.90.30 4305.20.00 4304.30.00 8917.40.00	430 10 MFZ430 430WGTZ KZIZ - 5	

Vehicle list

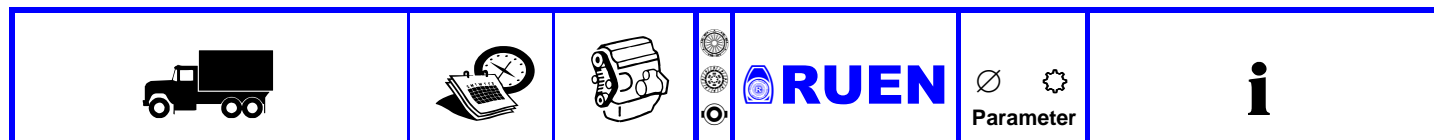

MERCEDES-BENZ

1748

748,1748 L	07.87 - 09.96	OM 442.985 OM 442.989	4000.90.03	400 10	
			4010.10.00	MFZ2/400X	
			4021.30.00	400GVZ	
			8928.40.00	KZIZ - 5	
			4307.20.00	430	- From chassis no.: K 011864
			4305.30.00	430 10	- To chassis no.: K 011864
			8905.40.00	KZIZ - 5	- From chassis no.: K 011864
1748 S,1748 LS	07.87 - 09.96	OM 442.985 OM 442.989	4000.90.03	400 10	
			4010.10.00	MFZ2/400X	
			4021.30.00	400GVZ	
			8928.40.00	KZIZ - 5	

1813

1813 6x2			2953.20.00	295	
			2954.30.00	295 10	
			6909.40.00	KZI - 3	
L 1813, 96kW			3120.20.00	310	- To chassis no.: 922885
			3101.20.00	310	- From chassis no.: 922886
			3124.30.00	310 10	
			6909.40.00	KZI - 3	
L 1813, 114kW L 1813, 123kW			3122.20.00	310	
			3126.30.00	310 10	

1814

1814	04.84 - 03.91	OM 366.906	3100.90.12	310 10	
			3164.20.00	MF310	
			3136.30.00	310WGSZ	
			6901.40.00	KZI - 3	

1817

L 1817			3522.20.00	350	
			3502.30.00	350 10	
			6915.40.00	KZI - 4	
LP 1817	06.69 -		3522.20.00	350	
			3502.30.00	350 10	
			6901.40.00	KZI - 3	
LP 1817	- 05.69		3502.20.00	350	





































1819

1819 6x4 L			3522.20.00	350	
			3502.30.00	350 10	

Vehicle list

					
---	---	---	--	---	---

MERCEDES-BENZ

1819						
L 1819			 3522.20.00	350 GF350KR		
			 3502.30.00	350 10 350GSZ		
			 6915.40.00	KZI - 4		
1820						
1820,1820 L	12.87 - 09.96	OM 356.984 OM 356.987 OM 357.925	 3500.90.11  3580.20.00  3583.30.00  8529.40.00	350 10 GMF350 350GSZ KZI - 4,5		
			 3822.20.00	380 GF380KR		
			 3888.30.00	380 10 380WGSZ		
			 8529.40.00	KZI - 4,5		
1820 AK 1820 K	07.93 - 09.96 05.92 - 09.96	OM 356.987 OM 357.925	 3500.90.11  3580.20.00  3583.30.00  8529.40.00	350 10 GMF350 350GSZ KZI - 4,5		
1824						
1824 652.006, 652.007, 652.008, 652.003, 652.004, 652.005, 652.009 1824,1824 L 652.006, 652.405, 652.408, 652.007, 652.008, 652.406, 652.407, 652.003, 652.004, 652.005, 652.009, 652.409 1824 AK 652.303, 652.336, 652.302, 180kW 1824 AK 652.303, 652.302, 180 - 230kW 1824 K 652.107, 652.106, 9572cc 1824 K 652.107, 652.106, 10964cc	01.94 - 09.96 12.87 - 09.96 08.92 - 09.96 01.94 - 09.96 08.92 - 09.96 01.94 - 09.96	OM 401.975 OM 401.984 OM 401.990 OM 445.924 OM 445.925 OM 445.930 OM 445.938 OM 445.941	 4300.90.29  4305.20.00  4346.30.00  8905.40.00	430 10 MFZ430 430WGTZ KZIZ - 5		
1824 652.036, 652.038, 652.033 1824 652.033 1824 AK 652.336	08.92 - 09.96 12.88 - 08.94 08.92 - 09.96	OM 356.999 OM 401.975 OM 442.907	 4300.90.18  4304.20.00  4316.30.00  8917.40.00	430 10 MFZ430 430WGTZ KZIZ - 5		
1827						
1827,1827 L, 9572cc 1827,1827 L, 10964cc	12.87 - 09.96 12.87 - 09.96	OM 401.973 OM 401.977 OM 401.991 OM 445.926 OM 445.936	 4300.90.29  4305.20.00  4346.30.00  8905.40.00	430 10 MFZ430 430WGTZ KZIZ - 5		
1827 AK, 9572cc 1827 AK, 10964cc	08.92 - 09.96 08.92 - 09.96	OM 401.973 OM 401.989 OM 445.933	 4300.90.29  4305.20.00  4346.30.00  8905.40.00	430 10 MFZ430 430WGTZ KZIZ - 5		
1827 S,1827 LS, 9572cc 1827 S,1827 LS, 10964cc	12.87 - 09.96 12.87 - 09.96	OM 401.973 OM 401.977 OM 401.991 OM 445.926 OM 445.936	 4305.20.00  4306.30.00  8917.40.00  4300.90.29  4305.20.00  4346.30.00  8905.40.00	430 MFZ430 430 10 430WGTZ KZIZ - 5 430 10 MFZ430 430WGTZ KZIZ - 5		







Vehicle list























































MERCEDES-BENZ

1831						
1831,1831 L, 9572cc	07.87 - 09.96	OM 401.972		4300.90.01	430 10	
1831,1831 L, 10964cc	07.87 - 09.96	OM 401.979		4304.20.00	MFZ430	
1831 AK, 9572cc	05.91 - 09.96	OM 401.986		4346.30.00	430WGTZ	
1831 AK, 10964cc	01.94 - 09.96	OM 401.993		8905.40.00	KZIZ - 5	
1831 K, 9572cc	07.92 - 09.96	OM 441.986				
1831 K, 10964cc	07.92 - 09.96	OM 441.993				
1831 S,1831 LS, 9572cc	07.87 - 09.96	OM 445.929				
1831 S,1831 LS, 10964cc	07.87 - 09.96	OM 445.930				
		OM 445.937				
1831,1831 L, 9572cc	12.87 - 09.96	OM 401.972		4300.90.01	430 10	
1831,1831 L, 10964cc	12.87 - 09.96	OM 401.979		4304.20.00	MFZ430	
1831 S,1831 LS, 9572cc	12.87 - 09.96	OM 401.993		4346.30.00	430WGTZ	
1831 S,1831 LS, 10964cc	12.87 - 09.96	OM 445.929		8905.40.00	KZIZ - 5	
		OM 445.937				
1831 LAS				4300.90.29	430 10	
				4305.20.00	MFZ430	
				4346.30.00	430WGTZ	
				8905.40.00	KZIZ - 5	
1834						
1834,1834 L 655.023, 655.422, 655.420, 655.421, 655.423, 655.021, 655.022, 655.020	07.87 - 09.96	OM 441.986		4300.90.01	430 10	
1834,1834 L 652.466, 652.068, 652.465, 652.066, 652.067, 652.478, 652.065, 652.468, 652.467	12.87 - 09.96	OM 441.987		4304.20.00	MFZ430	
1834 S,1834 LS 655.541, 655.543, 655.542, 655.548, 655.141, 655.142, 655.143	07.87 - 09.96	OM 441.989		4346.30.00	430WGTZ	
1834 S,1834 LS 652.161, 652.561, 652.562, 652.162, 652.163, 652.563	12.87 - 09.96	OM 441.991		8905.40.00	KZIZ - 5	
		OM 441.996				
		OM 445.920				
		OM 445.921				
		OM 445.939				
1834 AK 655.317	07.88 - 09.93	OM 441.989		4300.90.01	430 10	- Engine code: OM401LA,441LA
				4304.20.00	MFZ430	
				4346.30.00	430WGTZ	
				8905.40.00	KZIZ - 5	
1838						
1838				4300.90.07	430 10	
				4307.20.00	MFZ430	
				4346.30.00	430WGTZ	
				8905.40.00	KZIZ - 5	
1838,1838 L, 280kW, 12763cc	07.87 - 09.96	OM 402.971		4300.90.01	430 10	
1838,1838 L, 280kW, 14618cc	07.87 - 09.96	OM 402.972		4304.20.00	MFZ430	
1838,1838 L, 320kW	07.87 - 09.96	OM 402.975		4346.30.00	430WGTZ	
1838 K, 280kW	12.90 - 09.96	OM 402.978		8905.40.00	KZIZ - 5	
1838 K, 320kW	06.95 - 09.96	OM 402.985		4300.90.07	430 10	
1838 S,1838 LS, 280kW, 12763cc	07.87 - 09.96	OM 402.996		4307.20.00	MFZ430	
1838 S,1838 LS, 280kW, 14618cc	07.87 - 09.96	OM 440.978		4346.30.00	430WGTZ	
1838 S,1838 LS, 320kW	07.87 - 07.87	OM 440.979		8905.40.00	KZIZ - 5	
1838 AK, 280kW, 12763cc	12.92 - 09.96	OM 440.982		4010.10.00	400	
1838 AK, 280kW, 14618cc	01.94 - 09.96	OM 440.991			MFZ2/400X	
1838 AK, 320kW	12.92 - 09.96	OM 446.924		4021.30.00	400 10	
1838 AK, 370kW	12.92 - 09.96	OM 446.925			400GVZ	
		OM 446.927		8905.40.00	KZIZ - 5	
		OM 446.943				







Vehicle list

					
---	---	---	--	---	---







































MERCEDES-BENZ

1840						
1840 LS	07.91 - 07.92	OM 402.971	 4300.90.01  4304.20.00  4346.30.00  8905.40.00	430 10 MFZ430 430WGTZ KZIZ - 5	- Vehicles with single clutch disc	
			 4000.90.03  4010.10.00  4021.30.00  8928.40.00	400 10 MFZ2/400X 400GVZ KZIZ - 5	- Vehicles with double disc clutch	
			 4300.90.07  4307.20.00  4346.30.00  8905.40.00	430 10 MFZ430 430WGTZ KZIZ - 5	- Equipment Var: SA33613 02	
1844						
1844		442LA M 602.940	 4300.90.01  4304.20.00  4346.30.00  8905.40.00	430 10 MFZ430 430WGTZ KZIZ - 5		
			 4300.90.07  4307.20.00  4346.30.00  8905.40.00	430 10 MFZ430 430WGTZ KZIZ - 5	- Equipment Var: SA033617-01	
1844, 1844 L 1844 S, 1844 LS	07.87 - 09.96 07.87 - 09.96	OM 440.970 OM 440.978 OM 446.922 OM 446.924	 4300.90.01  4304.20.00  4346.30.00  8905.40.00	430 10 MFZ430 430WGTZ KZIZ - 5	- To chassis no.: K011863	
			 4300.90.07  4307.20.00  4346.30.00  8905.40.00	430 10 MFZ430 430WGTZ KZIZ - 5	- From chassis no.: K011864	
1850						
1850, 1850 L 655.496, 655.096, 655.337, 655.494	07.87 - 09.96	OM 440.973 OM 442.971 OM 442.985 OM 442.989 OM 442.992 OM 442.997	 4000.90.03  4010.10.00  4021.30.00  8928.40.00	400 10 MFZ2/400X 400GVZ KZIZ - 5	- To chassis no.: K011863 - Engine code: OM442LA - Equipment Var: SA33613-03	
			 4300.90.07  4307.20.00  4346.30.00  8905.40.00	430 10 MFZ430 430WGTZ KZIZ - 5	- From chassis no.: K011864	
1850			 4300.90.01  4304.20.00  4346.30.00  8905.40.00	430 10 MFZ430 430WGTZ KZIZ - 5		
			 4300.90.07  4307.20.00  4346.30.00  8905.40.00	430 10 MFZ430 430WGTZ KZIZ - 5	- Equipment Var: SA033617-01	
1850 LAS 655.592 1850 S, 1850 LS 655.192, 655.133, 655.193, 655.593, 655.592	07.87 - 09.96 07.87 - 09.96	OM 440.973 OM 442.971 OM 442.985 OM 442.989 OM 442.992 OM 442.997 OM 446.920	 4000.90.03  4010.10.00  4021.30.00  8928.40.00	400 10 MFZ2/400X 400GVZ KZIZ - 5	- To chassis no.: K011863 - Equipment Var: SA33613-03	
			 4300.90.07  4307.20.00  4346.30.00  8905.40.00	430 10 MFZ430 430WGTZ KZIZ - 5	- From chassis no.: K011864	







Vehicle list

					
---	---	---	--	---	---































MERCEDES-BENZ

1850						
1850 K 655.127	07.88 - 08.94	OM 442.997	 4300.90.01	430 10	- Engine code: OM442LA	
			 4304.20.00	MFZ430		
			 4346.30.00	430WGTZ		
			 8905.40.00	KZIZ - 5		
			 4300.90.07	430 10	- Equipment Var: SA033617-01 - Engine code: OM442LA	
 4307.20.00	MFZ430					
 4346.30.00	430WGTZ					
 8905.40.00	KZIZ - 5					
 3891.30.00	380 10					
	380GS					
 9302.40.00						
	KZI-6					
 3854.30.00	380 10					
	380GVZ					
1853						
1853,1853 L 1853 S,1853 LS	07.87 - 09.96	OM 446.920	 4000.90.03	400 10	- To chassis no.: K011863	
	01.87 - 09.96		 4010.10.00	MFZ2/400X		
			 4021.30.00	400GVZ		
			 8928.40.00	KZIZ - 5		
			 4300.90.07	430 10	- From chassis no.: K011864	
			 4307.20.00	MFZ430		
			 4346.30.00	430WGTZ		
			 8905.40.00	KZIZ - 5		
1853 AK	01.96 - 09.96	OM 446.920 OM 446.946	 4300.90.01	430 10		
			 4304.20.00	MFZ430		
			 4346.30.00	430WGTZ		
			 8905.40.00	KZIZ - 5		
			 4300.90.07	430 10	- Equipment Var: SA33617-01	
			 4307.20.00	MFZ430		
			 4346.30.00	430WGTZ		
			 8905.40.00	KZIZ - 5		
			 4000.90.03	400 10	- Equipment Var: SA25801-03	
			 4010.10.00	MFZ2/400X		
			 4021.30.00	400GVZ		
			 8928.40.00	KZIZ - 5		
1918						
L 1918 LK 1918			 3521.20.00	350		
			 3552.30.00	350 10		
				350		
LS 1918			 3822.20.00	380		
				GF380KR		
1919						
1919	05.74 - 08.82	OM 401.909 OM 401.916	 3821.20.00	380		
			 3821.30.00	380 10	- Special design	
			 3827.20.00	380		
				GF380KR		
			 8500.40.00			
				KZI - 4,5		
			 3871.30.00	380 10	- For PTO	
				380/70GSZ		

Vehicle list

					
---	---	---	--	---	---

MERCEDES-BENZ

1919						
1919 AK	05.74 - 08.82	OM 401.909		3821.20.00	380 GF380KR	
				3827.20.00	380 GF380KR	
				3821.30.00	380 10 380GSZ	
				8500.40.00	KZI - 4,5	
1919 K	05.74 - 08.82	OM 401.909		3821.20.00	380 GF380KR	
				3827.20.00	380 GF380KR	
				3821.30.00	380 10 380GSZ	
				8500.40.00	KZI - 4,5	
				3871.30.00	380 10 380/70GSZ	- For PTO
1919 S	05.74 - 08.82	OM 401.909		3821.20.00	380 GF380KR	
		OM 401.916		3827.20.00	380 GF380KR	
			3821.30.00	380 10 380GSZ		
			8500.40.00	KZI - 4,5		
1920						
L, LA, LK, LP, LS, LPS 1920				3822.20.00	380 GF380KR	
				3822.30.00	380 10 380GSZ	
1921						
1921				3521.20.00	350 GF350KR	
				3552.30.00	350 10 350	
				3822.20.00	380 GF380KR	
				3822.30.00	380 10 380GSZ	
				8502.40.00	KZI - 4	
L 1921 LK 1921 LS 1921				3822.20.00	380 GF380KR	
				3822.30.00	380 10 380GSZ	
				8502.40.00	KZI - 4	
1922						
1922, 159kW	10.81 - 10.90	OM 421.905		3821.20.00	380 GF380KR	- To chassis no.: 234953
				3821.30.00	380 10 380GSZ	- To chassis no.: 234953
				8500.40.00	KZI - 4,5	- To chassis no.: 234953 - From chassis no.: 234954
				4226.20.00	420 GF420KR	- From chassis no.: 234954
				4234.30.00	420 10 420/210GSZ	- From chassis no.: 234954
				4290.30.00	420 10 420GSZ	- From chassis no.: 234954
				4297.30.00	420 10 420GSZ	
				4289.30.00	420 10 420GSZ	- For PTO

Vehicle list



MERCEDES-BENZ

1922

1922, 160 - 165kW 1922 AK, 160 - 165kW 1922 K, 160 - 165kW 1922 S, 160 - 165kW	05.89 - 08.94 08.89 - 08.94 05.89 - 08.94 05.89 - 08.94	OM 441.905 OM 441.914 OM 441.923 OM 441.926	4300.90.18 4304.20.00 4316.30.00 8917.40.00	430 10 MFZ430 430WGTZ KZIZ - 5	
1922 AK, 141kW 1922 K, 141kW	10.81 - 03.91 10.81 - 03.91	OM 421.905	3821.20.00	380 GF380KR	- To chassis no.: 234953
			3821.30.00	380 10 380GSZ	- To chassis no.: 234953
			8500.40.00	KZI - 4,5	- To chassis no.: 234953 - From chassis no.: 234954
			4226.20.00	420 GF420KR	- From chassis no.: 234954
			4234.20.00	420 GF420KR	- From chassis no.: 234954
			4290.30.00	420 10 420GSZ	- From chassis no.: 234954
1922 S, 141kW	10.81 - 03.91	OM 421.905	4289.30.00	420 10 420GSZ	- For PTO
			3821.20.00	380 GF380KR	- To chassis no.: 234953
			3821.30.00	380 10 380GSZ	- To chassis no.: 234953
			8500.40.00	KZI - 4,5	- To chassis no.: 234953 - From chassis no.: 234954
			4226.20.00	420 GF420KR	- From chassis no.: 234954
			4234.20.00	420 GF420KR	- From chassis no.: 234954
4290.30.00	420 10 420GSZ	- From chassis no.: 234954			

1923

L 1923 LA 1923 LP 1923			3822.20.00	380 GF380KR	
			3822.30.00	380 10 380GSZ	

1924

1924 336, 346, 336 L, LA, LP, LS, LK 1924 346.111-114, 346.323, 346.355, 346.324, 346.311-314, 346.352, 346.365, 346.361, 346.362, 346.351 LAK, LAS, LPS 1924 346.111-114, 346.323, 346.355, 346.324, 346.311-314, 346.352, 346.365, 346.361, 346.362, 346.351			3822.20.00	380 GF380KR	
			3822.30.00	380 10 380GSZ	
			8502.40.00	KZI - 4	
L, LK, LS 1924 346.013, 346.001-004			3821.20.00	380 GF380KR	
			3821.30.00	380 10 380GSZ	
			8503.40.00	KZI - 4,5	





































1926

1926			4300.90.30 4305.20.00 4304.30.00 8917.40.00	430 10 MFZ430 430WGTZ KZIZ - 5	
------	--	--	--	--	--







Vehicle list

					
---	---	---	--	---	---





















































MERCEDES-BENZ

1926						
1926 389.016, 389.017, 652.046, 389.019, 389.018, 188kW	05.74 - 12.80	OM 402.906 OM 402.912	 3821.20.00	380 GF380KR		
			 3821.30.00	380 10 380GSZ		
			 8500.40.00	KZI - 4,5		
			 4289.30.00	420 10 420GSZ	- From chassis no.: 4372224 - For PTO	
1926 S, 1926 LS 389.012, 389.013, 389.014, 389.213 1926 AS 389.112	08.73 - 09.96	OM 402.906 OM 402.912	 3821.20.00	380 GF380KR		
	05.74 - 12.80	OM 402.916	 3821.30.00	380 10 380GSZ		
			 8500.40.00	KZI - 4,5		
1926 A 389.115, 389.116 1926 AK 389.144 1926 K 389.043, 389.044	05.74 - 12.80	OM 402.906	 4289.30.00	420 10 420GSZ	- From chassis no.: 4372224 - For PTO	
	08.73 - 12.80	OM 402.912	 3821.20.00	380 GF380KR		
	08.73 - 12.80		 3821.30.00	380 10 380GSZ		
			 8500.40.00	KZI - 4,5		
LP 1926 363.030-032, 363.040-042 LPS 1926 363.030-032, 363.040-042			 3822.20.00	380 GF380KR		
			 3822.30.00	380 10 380GSZ		
1926 652.046	12.87 - 09.96	OM 442.914 OM 442.922 OM 442.932	 4300.90.30	430 10	- Engine code: OM442	
			 4305.20.00	MFZ430		
			 4304.30.00	430WGTZ		
			 8917.40.00	KZIZ - 5		
			 4244.30.00	420 10 420/210GSZ	- Engine code: OM442	
1927						
1927 AK			 4300.90.18	430 10		
			 4304.20.00	MFZ430		
			 4316.30.00	430WGTZ		
			 8917.40.00	KZIZ - 5		
1928						
1928			 3821.20.00	380 GF380KR		
			 3821.30.00	380 10 380GSZ		
			 8503.40.00	KZI - 4,5		
1928, 1928 L 1928 A 1928 AK 1928 AS	08.73 - 09.96	OM 422.905	 4200.90.16	420 10		
	01.80 - 03.91	OM 422.906	 4235.20.00	GF420KR		
	01.80 - 03.91	OM 422.907	 4257.30.00	420GSZ		
	01.80 - 03.91	OM 422.911 OM 422.913	 8500.40.00	KZI - 4,5		
			 4225.20.00	420 GF420KR		
			 4298.30.00	420 10 420GSZ	- For PTO	
1928 K 1928 L, LK, LS	01.80 - 03.91	OM 422.905 OM 422.907 OM 422.911 OM 422.913	 4200.90.16	420 10		
			 4235.20.00	GF420KR		
			 4257.30.00	420GSZ		
			 8500.40.00	KZI - 4,5		
			 4225.20.00	420 GF420KR		







Vehicle list

					
---	---	---	--	---	---

MERCEDES-BENZ





1928					
1928 S, 1928 LS	08.73 - 09.96	OM 422.906 OM 422.911	 4200.90.16	420 10	
			 4235.20.00	GF420KR	
			 4257.30.00	420GSZ	
			 4225.20.00	420	
			 4298.30.00	420 10	- For PTO
			 8500.40.00	KZI - 4,5	
			 4225.20.00	GF420KR	
			 4235.20.00		
			 4257.30.00		
			 8500.40.00		
1929					
1929, 1929 L	07.87 - 09.96	OM 442.906 OM 442.907 OM 442.908 OM 442.916 OM 442.923 OM 442.925	 4300.90.30	430 10	
			 4305.20.00	MFZ430	
			 4304.30.00	430WGTZ	
			 4300.90.28	430 10	
			 4305.20.00	MFZ430	
			 4346.30.00	430WGTZ	
			 8905.40.00	KZIZ - 5	
1929 A, 210 - 218kW 1929 A, 269kW 1929 A, 340kW 1929 AK	07.88 - 08.94	OM 442.906 OM 442.907 OM 442.909 OM 442.924 OM 442.971 OM 443.940	 4300.90.30	430 10	
			 4305.20.00	MFZ430	
			 4304.30.00	430WGTZ	
			 8917.40.00	KZIZ - 5	
1929 AS 1929 S 1929 K	07.88 - 08.94	OM 442.906 OM 442.907 OM 442.908 OM 442.916 OM 442.923 OM 442.925 OM 442.926 OM 442.929	 4300.90.30	430 10	
			 4305.20.00	MFZ430	
			 4304.30.00	430WGTZ	
			 8917.40.00	KZIZ - 5	
			 4300.90.28	430 10	
			 4305.20.00	MFZ430	
			 4346.30.00	430WGTZ	
			 8905.40.00	KZIZ - 5	
1932					
1932			 4250.20.00	420	
			 4257.30.00	GF420KR	
			 4257.30.00	420 10	
			 4257.30.00	420GSZ	
1932 1932 A 1932 AS 1932 S, 1932 LS	05.74 - 03.83 05.74 - 03.83 05.74 - 12.82 08.73 - 09.96	OM 403.916 OM 403.931	 4200.90.16	420 10	
			 4235.20.00	GF420KR	
			 4257.30.00	420GSZ	
			 8500.40.00	KZI - 4,5	
			 4225.20.00	420	
			 4225.20.00	GF420KR	
1932 AK 1932 K	08.73 - 09.83 08.73 - 08.82	OM 403.916 OM 403.931	 4200.90.16	420 10	
			 4235.20.00	GF420KR	
			 4257.30.00	420GSZ	
			 8500.40.00	KZI - 4,5	
			 4225.20.00	420	
			 4225.20.00	GF420KR	
			 4298.30.00	420 10	- For PTO
			 4298.30.00	420GSZ	
LP 1932 LPS 1932			 4225.20.00	420	
			 4225.20.00	GF420KR	
			 4235.20.00	420	
			 4235.20.00	GF420KR	
			 4231.30.00	420 10	
			 4231.30.00	420GSZ	

Vehicle list





















					
---	---	---	--	---	---

MERCEDES-BENZ





1933

1933 1933 S, 1933 LS	11.80 - 03.91	OM 422.952		4244.20.00	420 GFX420KR	
	08.73 - 09.96	OM 422.954		4266.30.00	420 10 420/210GSZ	
		OM 422.956		8513.40.00	KZI - 4.5	
		OM 422.957 OM 422.958		4287.30.00	420 10 420GVZ	- For PTO

1935

1935				4304.20.00	430 MFZ430	
				4304.30.00	430 10 430WGTZ	
				8917.40.00	KZIZ - 5	
1935 646.076, 646.025, 646.027, 646.077, 646.026, 260kW 1935 AK 646.322, 646.327, 260 - 269kW 1935 S, 1935 LS 646.522, 646.572, 646.172, 646.122, 646.121, 646.523, 646.123, 646.573	02.86 - 09.89	OM 442.950		3882.10.00	380 GF2/380	- This part number includes one clutch disc
	09.87 - 03.91	OM 442.952 OM 442.962		3855.30.00	380 10 380GS	- Loose clutch disc
	08.73 - 09.96			8520.40.00	KZI - 4,5	
				3882.20.00	380 GF2/380	- Contained in xxxx.10.00
				3882.50.00	380 GF2/380	- Contained in xxxx.10.00
				3883.30.00	380 10 380GSZ	- Contained in xxxx.10.00
1935 656.024, 656.215, 656.026, 656.074, 656.076, 656.025, 656.028, 656.078, 260 - 269kW 1935 AK 656.327, 656.327.11, 250 - 269kW 1935 AS 656.322 1935 K 656.127 1935 S 656.122, 656.172, 656.123	05.89 - 08.94	OM 440.940		4300.90.01	430 10 MFZ430	
		OM 442.942		4304.20.00	430WGTZ	
		OM 442.943		4346.30.00	KZIZ - 5	
	05.89 - 08.94	OM 442.944		8905.40.00		
	05.89 - 08.94	OM 442.963				
	05.89 - 08.94	OM 442.964				
	05.89 - 08.94	OM 442.966				
		OM 442.971				
		OM 442.972				
		OM 442.976 OM 442.977 OM 442.978				
1935 656.215				4304.20.00	430 MFZ430	- Engine code: OM442
				4304.30.00	430 10 430WGTZ	- Engine code: OM442
				8917.40.00	KZIZ - 5	- Engine code: OM442
1935 AS 646.322	09.87 - 03.91	OM 442.962		3882.10.00	380 GF2/380	
				3855.30.00	380 10 380GS	
				3882.20.00	380 GF2/380	
				3882.50.00	380 GF2/380	
				3891.30.00	380 10 380GS	- Engine code: OM422A - For PTO

1936

1936	10.81 - 03.91	OM 423.905 OM 423.906 OM 423.908		4244.20.00	420 GFX420KR	
				4266.30.00	420 10 420/210GSZ	
				8513.40.00	KZI - 4.5	
				4287.30.00	420 10 420GVZ	- For PTO

Vehicle list



MERCEDES-BENZ

1936

1936 AK 1936 AS 1936 K 1936 S, 1936 LS	10.81 - 03.91	OM 423.905		4244.20.00	420 GFX420KR		
	10.81 - 03.91	OM 423.906		4266.30.00	420 10 420/210GSZ		
	10.81 - 03.91	OM 423.907		8513.40.00	KZI - 4,5		
	08.73 - 09.96	OM 423.908		4287.30.00	420 10 420GVZ	- For PTO	
				3857.10.00	380 GF2/380	- This part number includes one clutch disc	
				3892.30.00	380 10 380GSZ	- Loose clutch disc	
					8520.40.00	KZI - 4,5	
					3857.20.00	380 G380KR	- Contained in xxxx.10.00
					3857.50.00	380 GF2/380	- Contained in xxxx.10.00

1938

1938 1938 S, 1938 LS	11.80 - 06.90	OM 422.953		3857.10.00	380 GF2/380	- This part number includes one clutch disc
	08.73 - 09.96	OM 422.955		3892.30.00	380 10 380GSZ	- Loose clutch disc - Contained in xxxx.10.00
		OM 422.959		8520.40.00	KZI - 4,5	
				3857.20.00	380 G380KR	- Contained in xxxx.10.00
				3857.50.00	380 GF2/380	- Contained in xxxx.10.00

1944

1944 1944 S, 1944 LS	10.85 - 12.89	OM 442.951		3887.10.00	380 GF2/380	- This part number includes one clutch disc	
	08.73 - 09.96			3891.30.00	380 10 380GS	- Loose clutch disc	
					8520.40.00	KZI - 4,5	
					3882.20.00	380 GF2/380	- Contained in xxxx.10.00
					3882.50.00	380 GF2/380	- Contained in xxxx.10.00
					3889.30.00	380 10 380GSZ	- Contained in xxxx.10.00

1945

1945 AK	07.88 - 08.94	OM 443.940		4300.90.30	430 10 MFZ430	
				4305.20.00	430WGTZ	
				4304.30.00	KZIZ - 5	
				8917.40.00		
				3887.10.00	380 GF2/380	- This part number includes one clutch disc
				3891.30.00	380 10 380GS	- Loose clutch disc
				8520.40.00	KZI - 4,5	
				3882.20.00	380 GF2/380	- Contained in xxxx.10.00
	3882.50.00	380 GF2/380	- Contained in xxxx.10.00			
	3889.30.00	380 10 380GSZ	- Contained in xxxx.10.00			

Vehicle list



MERCEDES-BENZ

1948

1948 656.096, 656.094, 656.095, 353 - 362kW	09.88 - 07.92	OM 442.982 OM 442.984 OM 442.985 OM 442.989	4000.90.03	400 10	- To chassis no.: K011863
			4010.10.00	MFZ2/400X	
			4021.30.00	400GVZ	
			8928.40.00	KZIZ - 5	
			4300.90.07	430 10	- From chassis no.: K011863
			4307.20.00	MFZ430	
			4346.30.00	430WGTZ	
			8905.40.00	KZIZ - 5	
			4010.10.00	400	- Special design
				MFZ2/400X	- This part number includes one clutch disc
			4021.30.00	400 10	- Special design
				400GVZ	- Loose clutch disc
			8928.40.00	KZIZ - 5	- Special design
1948 AK 656.317			3887.10.00	380	- This part number includes one clutch disc
				GF2/380	
			3891.30.00	380 10	- Loose clutch disc
				380GS	
			8520.40.00	KZI - 4,5	
			3882.20.00	380	- Contained in xxxx.10.00
	GF2/380				
			3882.50.00	380	- Contained in xxxx.10.00
				GF2/380	
			3889.30.00	380 10	- Contained in xxxx.10.00
				380GSZ	- Special design
1948 656.215, 656.317			3891.30.00	380 10	- Loose clutch disc
				380GS	
			9302.40.00	KZI-6	
			3854.30.00	380 10	
				380GVZ	

1953

1953			4000.90.03	400 10	
			4010.10.00	MFZ2/400X	
			4021.30.00	400GVZ	
			8928.40.00	KZIZ - 5	







2020

2020 L	01.84 - 12.98	OM 366.988 OM 366.992 OM 366.995 OM 366.997	3580.20.00	350	
				GMF350	
			3583.30.00	350 10	
				350GSZ	
			8529.40.00	KZI - 4,5	
L,LA,LB,LAB 2220 LPS 2020			3822.20.00	380	
				GF380KR	
			3822.30.00	380 10	
				380GSZ	
			8502.40.00	KZI - 4	





































2023

LPS 2023			3822.20.00	380	
				GF380KR	
			3822.30.00	380 10	
				380GSZ	
			8502.40.00	KZI - 4	

Vehicle list

					
---	---	---	--	---	---

MERCEDES-BENZ

2024					
2024			 3882.20.00	380 GF2/380	
			 3822.30.00	380 10 380GSZ	
			 8502.40.00	KZI - 4	
2024, 180kW, 9600cc 2024, 180kW, 10964cc 2024 AK, 180kW, 9600cc 2024 AK, 180kW, 10964cc 2024 K, 180kW, 9600cc 2024 K, 180kW, 10964cc	02.93 - 09.96 01.94 - 09.96 02.93 - 09.96 01.94 - 09.96 02.93 - 09.96 01.94 - 09.96	OM 401.975 OM 401.984 OM 445.924 OM 445.925	 4300.90.29  4305.20.00  4346.30.00  8905.40.00	430 10 MFZ430 430WGTZ KZIZ - 5	
2024 AK			 4300.90.18  4304.20.00  4316.30.00  8917.40.00	430 10 MFZ430 430WGTZ KZIZ - 5	
2024 L	01.84 - 12.98	OM 356.999 OM 357.941 OM 357.947	 3822.20.00	380 GF380KR	
			 3821.20.00	380 GF380KR	
			 8529.40.00	KZI - 4,5	
LPS 2024			 3822.20.00	380 GF380KR	
			 3822.30.00	380 10 380GSZ	
			 8502.40.00	KZI - 4	
2025					
2025 S	08.83 - 03.91	OM 422.909	 3831.20.00	380 GF380KR	
			 3821.30.00	380 10 380GSZ	
			 8500.40.00	KZI - 4,5	
2026					
2026 S	10.76 - 10.80	OM 402.912 OM 402.916	 3821.20.00	380 GF380KR	
			 3821.30.00	380 10 380GSZ	
			 8500.40.00	KZI - 4,5	
2027					
2027 AK	02.93 - 09.96	OM 401.989	 4300.90.29  4305.20.00  4346.30.00  8905.40.00	430 10 MFZ430 430WGTZ KZIZ - 5	
2028					
2028 A	01.80 - 06.89	OM 422.907 OM 422.911 OM 422.913 OM 422.916	 4200.90.16  4235.20.00  4257.30.00  8500.40.00	420 10 GF420KR 420GSZ KZI - 4,5	
			 4298.30.00	420 10 420GSZ	- For PTO
2028 LS	01.80 - 06.89	OM 422.905 OM 422.906 OM 422.910 OM 422.911	 4200.90.16  4235.20.00  4257.30.00  8500.40.00	420 10 GF420KR 420GSZ KZI - 4,5	
			 4225.20.00	420 GF420KR	

Vehicle list



MERCEDES-BENZ

2031

2031				4300.90.30 4305.20.00 4304.30.00 8917.40.00	430 10 MFZ430 430WGTZ KZIZ - 5	
2031 2031 A, 230kW, 9572cc 2031 A, 230kW, 10964cc 2031 A, 280kW, 12763cc 2031 A, 280kW, 14618cc 2031 A, 320kW 2031 AS 2031 S 2031 K, 9572cc 2031 K, 10964cc	03.92 - 09.96 03.92 - 09.96 01.94 - 09.96 03.92 - 09.96 01.94 - 09.96 03.92 - 09.96 03.92 - 09.96 03.92 - 09.96 03.92 - 09.96 03.92 - 09.96	OM 401.972 OM 401.979 OM 401.986 OM 401.993 OM 402.978 OM 402.996 OM 440.979 OM 445.929 OM 445.930 OM 446.927		4300.90.01 4304.20.00 4346.30.00 8905.40.00	430 10 MFZ430 430WGTZ KZIZ - 5	

2032

2032 6x2				4250.20.00	420 GFX420KR	
				4257.30.00	420 10 420GSZ	
2032 S	08.75 - 09.83	OM 403.931 OM 403.932		4200.90.16 4235.20.00 4257.30.00 8500.40.00	420 10 GF420KR 420GSZ KZI - 4,5	
				4225.20.00	420 GF420KR	
LPS 2032				4225.20.00	420 GF420KR	
				4235.20.00	420 GF420KR	
				4231.30.00	420 10 420GSZ	







2033

2033 LS	12.81 - 05.87	OM 422.952 OM 422.956		3857.10.00	380 GF2/380	- This part number includes one clutch disc
				3892.30.00	380 10 380GSZ	- Loose clutch disc - Contained in xxxx.10.00
				8520.40.00	KZI - 4,5	
				3857.20.00	380 G380KR	- Contained in xxxx.10.00
				4244.20.00	420 GFX420KR	
				4260.30.00	420 10 420GSZ	
				8513.40.00	KZI - 4.5	

2035







2035 S, 2035 LS	08.73 - 09.96	OM 442.950 OM 442.952 OM 442.958		3882.10.00	380 GF2/380	- This part number includes one clutch disc
				3855.30.00	380 10 380GS	- Loose clutch disc
				8520.40.00	KZI - 4,5	
				3882.20.00	380 GF2/380	- Contained in xxxx.10.00
				3882.50.00	380 GF2/380	- Contained in xxxx.10.00
				3883.30.00	380 10 380GSZ	- Contained in xxxx.10.00

Vehicle list









					
---	---	---	--	---	---

MERCEDES-BENZ











2036

2036 A	01.80 - 06.89	OM 442.950 OM 442.962	 4200.90.16  4235.20.00  4257.30.00  8500.40.00	420 10 GF420KR 420GSZ KZI - 4,5	
2036 LS	03.84 - 03.91	OM 423.905 OM 423.908	 4244.20.00	420 GFX420KR	
			 4260.30.00	420 10 420GSZ	
			 8513.40.00	KZI - 4.5	









2038

2038, 12763cc	11.91 - 09.96	OM 402.971	 4300.90.01  4304.20.00  4346.30.00  8905.40.00	430 10 MFZ430 430WGTZ KZIZ - 5	
2038, 14618cc	12.92 -	OM 402.972			
2038 AS, 280kW, 12763cc	12.92 - 09.96	OM 402.978	 4300.90.07  4307.20.00  4346.30.00  8905.40.00	430 10 MFZ430 430WGTZ KZIZ - 5	- Equipment Var: SA033617-01
2038 AS, 280kW, 14618cc	01.94 - 09.96	OM 402.985			
2038 AS, 320kW	12.92 - 09.96	OM 402.986			
2038 S	11.91 - 09.96	OM 402.996			
		OM 440.970			
		OM 440.979			
		OM 446.925			
		OM 446.927			









2044

2044 656.091, 656.092, 656.190, 656.034, 655.337, 656.093 2044 S 656.190	01.92 - 09.96	OM 440.970	 4000.90.03  4010.10.00  4021.30.00  8928.40.00	400 10 MFZ2/400X 400GVZ KZIZ - 5	- To chassis no.: K011863
	01.92 - 09.96	OM 440.978 OM 446.922			
			 4300.90.07  4307.20.00  4346.30.00  8905.40.00	430 10 MFZ430 430WGTZ KZIZ - 5	- From chassis no.: K011864
2044 AS 656.332	01.94 - 09.96	OM 440.970 OM 440.979	 3891.30.00	380 10 380GS	- Loose clutch disc
			 9302.40.00	KZI-6	
			 3854.30.00	380 10 380GVZ	

2050

2050 2050 S	01.91 - 09.96	OM 440.976	 4300.90.01  4304.20.00  4346.30.00  8905.40.00	430 10 MFZ430 430WGTZ KZIZ - 5	- To chassis no.: K011863 - Equipment Var: SA33613-03
	01.91 - 09.96	OM 442.985 OM 442.989 OM 442.992 OM 442.997 OM 446.920			
			 4300.90.07  4307.20.00  4346.30.00  8905.40.00	430 10 MFZ430 430WGTZ KZIZ - 5	- From chassis no.: K011864



































2055

2055 AF 656.091	01.92 - 09.96	OM 442.997	 4000.90.03  4010.10.00  4021.30.00  8928.40.00	400 10 MFZ2/400X 400GVZ KZIZ - 5	- To chassis no.: K011863 - Vehicles with double disc clutch
			 4300.90.07  4307.20.00  4346.30.00  8905.40.00		







Vehicle list

					
---	---	---	--	---	---



































MERCEDES-BENZ

2219						
2219	06.76 - 01.87	OM 401.914		3580.20.00	350 GMF350	
2219 K	06.76 - 01.87	OM 401.923		3583.30.00	350 10 350GSZ	
2219 KO	06.76 - 01.87	OM 401.925				
2219,2219 L	08.73 - 09.96	OM 401.926 OM 401.927		8509.40.00	KZI - 4,5	
2219 C,2219 CL	08.73 - 09.96	OM 362.906 OM 362.909		3583.30.00	350 10 350GSZ	
				3580.20.00	350 GMF350	- Only install together
				3517.30.00	350 10 350WGSZ	- Only install together
				8529.40.00	KZI - 4,5	
LP,LPB 2219				3502.30.00	350 10 350GSZ	
LP,LPK 2219				3522.30.00	350 10 350GSZ	
				3502.30.00	350 10 350GSZ	
				6915.40.00	KZI - 4	
2220						
2220,2220 L	08.73 - 09.96	OM 366.983		3583.30.00	350 10 350GSZ	
				3580.20.00	350 GMF350	- Only install together
				3517.30.00	350 10 350WGSZ	- Only install together
				8529.40.00	KZI - 4,5	
2222						
2222 2222 K	05.82 - 03.91 05.82 - 03.91	OM 421.905		3821.20.00	380 GF380KR	- To chassis no.: 234953
				3821.30.00	380 10 380GSZ	- To chassis no.: 234953
				8500.40.00	KZI - 4,5	- To chassis no.: 234953 - From chassis no.: 234954
				4226.20.00	420 GF420KR	- From chassis no.: 234954
				4234.20.00	420 GF420KR	- From chassis no.: 234954
				4290.30.00	420 10 420GSZ	- From chassis no.: 234954
				4289.30.00	420 10 420GSZ	- For PTO
2222,2222 L	08.73 - 09.96	OM 421.905		4200.90.16	420 10 GF420KR	
				4235.20.00	420GSZ	
				4257.30.00	KZI - 4,5	
				8500.40.00		
				3821.20.00	380 GF380KR	- To chassis no.: 234953
				3821.30.00	380 10 380GSZ	- To chassis no.: 234953
				8511.40.00	KZI - 4,5	- To chassis no.: 234953 - From chassis no.: 234954
				4226.20.00	420 GF420KR	- From chassis no.: 234954
				4234.20.00	420 GF420KR	- From chassis no.: 234954
				4290.30.00	420 10 420GSZ	- From chassis no.: 234954
	4289.30.00	420 10 420GSZ	- For PTO			

Vehicle list

					
---	---	---	--	---	---































MERCEDES-BENZ

2222						
2222 B	05.82 - 03.91	OM 421.905 OM 421.907 OM 441.906	 4200.90.16	420 10		
			 4235.20.00	GF420KR		
			 4257.30.00	420GSZ		
			 8500.40.00	KZI - 4,5		
			 4225.20.00	420	GF420KR	
			 4289.30.00	420 10	420GSZ	- For PTO
2223						
L,LH,LP,LPS,LPB 2223 LP 2223			 3822.20.00	380	GF380KR	
			 3822.30.00	380 10	380GSZ	
			 8502.40.00	KZI - 4		
2224						
2224 385.332, 385.333, 385.338, 385.335	04.76 - 12.82	OM 402.911 OM 402.928	 3821.20.00	380	GF380KR	
			 3821.30.00	380 10	380GSZ	
			 8500.40.00	KZI - 4,5		
2224 385.385, 385.383, 385.387	04.76 - 12.82	OM 402.911 OM 402.928	 3821.20.00	380	GF380KR	
			 3821.30.00	380 10	380GSZ	
			 8500.40.00	KZI - 4,5		
			 4289.30.00	420 10	420GSZ	- For PTO
2224 B 385.398, 385.394, 385.396	05.75 - 03.84	OM 402.914	 4222.20.00	420	GF420KR	- To model year: 08.1976
			 4297.30.00	420 10	420GSZ	- To model year: 08.1976 - From model year: 09.1976
			 8500.40.00	KZI - 4,5		- To model year: 08.1976 - From model year: 09.1976
			 4226.20.00	420	GF420KR	- From model year: 09.1976
			 4289.30.00	420 10	420GSZ	- For PTO
			 4200.90.16	420 10	GF420KR	
			 4235.20.00	GF420KR		
 4257.30.00	420GSZ					
 8500.40.00	KZI - 4,5					
 4225.20.00	420	GF420KR				
2224 K 385.395, 385.397	04.76 - 12.82	OM 402.910 OM 402.927	 3821.20.00	380	GF380KR	
			 3821.30.00	380 10	380GSZ	
			 8500.40.00	KZI - 4,5		
			 3871.30.00	380 10	380/70GSZ	- For PTO
			 4289.30.00	420 10	420GSZ	- For PTO
2224 S 385.399	07.76 - 12.82	OM 402.911 OM 402.928	 3821.20.00	380	GF380KR	
			 3821.30.00	380 10	380GSZ	
			 8500.40.00	KZI - 4,5		







Vehicle list

					
---	---	---	--	---	---





































MERCEDES-BENZ

2224						
LP 2224				4225.20.00	420 GF420KR	
				4235.20.00	420 GF420KR	
				4231.30.00	420 10 420GSZ	
				8502.40.00	KZI - 4	
LP,LPB,LPK,LPS 2224 355.462, 361.453, 361.467, 355.452, 361.455-457, 361.465, 361.463				3822.20.00	380 GF380KR	
				3822.30.00	380 10 380GSZ	
				8502.40.00	KZI - 4	
LP,LPB,LPS 2224 361.456, 361.453, 361.455, 361.465, 361.463				3872.30.00	380 10 380GSZ	
2225						
2225 619.034, 617.033, 619.017, 619.019	04.85 - 03.91	OM 422.909		3831.20.00	380 GF380KR	
				3821.30.00	380 10 380GSZ	
				8500.40.00	KZI - 4,5	- To chassis no.: 5107148
				8511.40.00	KZI - 4.5	- From chassis no.: 5107149
2225 B 619.049, 617.532, 619.048	08.83 - 03.91	OM 422.912		4225.20.00	420 GF420KR	
				4235.20.00	420 GF420KR	
				4258.30.00	420 10 420GSZ	
				8511.40.00	KZI - 4.5	
				4289.30.00	420 10 420GSZ	- For PTO
2225 L 617.435, 617.436	08.73 - 09.96	OM 422.909		3831.20.00	380 GF380KR	- Engine code: OM422
				3897.30.00	380 10 380GSZ	- Engine code: 1878 000 105
				8511.40.00	KZI - 4.5	- From chassis no.: 5107149 - Engine code: OM422
2226						
2226 393.316, 393.315 2226,2226 L 393.376, 393.574, 393.576, 393.575, 393.374, 393.375, 393.377	09.75 - 12.80 08.73 - 09.96	OM 402.912 OM 402.916 OM 402.924		3821.20.00	380 GF380KR	
				3821.30.00	380 10 380GSZ	
				8500.40.00	KZI - 4,5	
LP,LPB,LPK,LPS 2226 363.471-474, 363.026, 363.482, 363.021, 363.481				3822.20.00	380 GF380KR	
				3822.30.00	380 10 380GSZ	
LPB 2226				3872.30.00	380 10 380GSZ	
2227						
LP 2217	06.69 -			3522.20.00	350 GF350KR	
				3502.30.00	350 10 350GSZ	
				6901.40.00	KZI - 3	
LP 2217	- 05.69			3502.30.00	350 10 350GSZ	
LPB 2217						







Vehicle list

					
---	---	---	--	---	---































MERCEDES-BENZ

2228					
2228	12.79 - 03.91	OM 422.905 OM 422.911	 4200.90.16	420 10	
			 4235.20.00  4257.30.00  8500.40.00	GF420KR 420GSZ KZI - 4,5	
			 4225.20.00	420	GF420KR
2228 S	12.79 - 03.91	OM 422.905 OM 422.911	 4244.20.00	420	GFX420KR
			 4260.30.00	420 10	420GSZ
			 8513.40.00		KZI - 4.5
			 4225.20.00	420	GF420KR
			 4235.20.00	420	GF420KR
			 4258.30.00	420 10	420GSZ
			 8500.40.00		KZI - 4,5
2228,2228 L	08.73 - 09.96	OM 422.905 OM 422.906 OM 422.911	 4225.20.00	420	GF420KR
			 4235.20.00	420	GF420KR
			 4258.30.00	420 10	420GSZ
			 8500.40.00		KZI - 4,5
			 4298.30.00	420 10	420GSZ - For PTO
2232					
2232			 3821.20.00	380	GF380KR
			 3821.30.00	380 10	380GSZ
			 8500.40.00		KZI - 4,5
			 4250.20.00	420	GFX420KR
			 4257.30.00	420 10	420GSZ
2232 2232,2232 L 2232 S,2232 LS	05.74 - 09.83		 4200.90.16	420 10	
	08.73 - 09.96		 4235.20.00  4257.30.00  8500.40.00	GF420KR 420GSZ KZI - 4,5	
	08.73 - 09.96		 4225.20.00	420	GF420KR
2232 L			 3821.20.00	380	GF380KR
			 3821.30.00	380 10	380GSZ
			 8500.40.00		KZI - 4,5
LP 2232			 3822.20.00	380	GF380KR
			 3822.30.00	380 10	380GSZ
LP 2232			 4298.20.00	420	GF420
LP,LPL,LPK,LPS 2232			 4225.20.00	420	GF420KR
			 4235.20.00	420	GF420KR
			 4231.30.00	420 10	420GSZ







Vehicle list

					
---	---	---	--	---	---



























MERCEDES-BENZ

2233					
2233 2233,2233 L	11.80 - 05.87 08.73 - 09.96	OM 422.952 OM 422.954 OM 422.957 OM 422.958	 4244.20.00	420 GFX420KR	
			 4260.30.00	420 10 420GSZ	
			 8513.40.00	KZI - 4.5	
			 4287.30.00	420 10 420GVZ	- For PTO
2233 S	11.80 - 05.87	OM 422.957 OM 422.958	 4244.20.00	420 GFX420KR	
			 4260.30.00	420 10 420GSZ	
			 8513.40.00	KZI - 4.5	
			 3857.10.00	380 GF2/380	- This part number includes one clutch disc
			 3892.30.00	380 10 380GSZ	- Loose clutch disc - Contained in xxxx.10.00
			 8520.40.00	KZI - 4,5	
			 3857.20.00	380 G380KR	- Contained in xxxx.10.00
			 3857.50.00	380 GF2/380	- Contained in xxxx.10.00
2235					
2235,2235 L 2235 K 2235 S, 2235 LS	08.73 - 09.96 03.86 - 07.89 08.73 - 09.96	OM 442.950	 3882.10.00	380 GF2/380	- This part number includes one clutch disc
			 3855.30.00	380 10 380GS	- Loose clutch disc
			 8520.40.00	KZI - 4,5	
			 3882.20.00	380 GF2/380	- Contained in xxxx.10.00
			 3882.50.00	380 GF2/380	- Contained in xxxx.10.00
			 3883.30.00	380 10 380GSZ	- Contained in xxxx.10.00
2236					
2236	09.82 - 03.91	OM 423.905 OM 423.908	 4200.90.16	420 10 GF420KR	
			 4235.20.00	420GSZ	
			 4257.30.00	KZI - 4,5	
			 8500.40.00		
			 4225.20.00	420 GF420KR	
			 4244.20.00	420 GFX420KR	
			 4260.30.00	420 10 420GSZ	
			 8513.40.00	KZI - 4.5	
2236 S	12.84 - 03.91	OM 423.905 OM 423.908	 4287.30.00	420 10 420GVZ	- For PTO
			 4244.20.00	420 GFX420KR	
			 4260.30.00	420 10 420GSZ	
			 8513.40.00	KZI - 4.5	

Vehicle list

					
---	---	---	--	---	---

MERCEDES-BENZ

2238						
2238,2238 L	08.73 - 09.96	OM 422.953		3857.10.00	380 GF2/380	- This part number includes one clutch disc
2238 S	01.81 - 12.86	OM 422.955 OM 422.959		3892.30.00	380 10 380GSZ	- Loose clutch disc - Contained in xxxx.10.00
				8520.40.00	KZI - 4,5	
				3857.20.00	380 G380KR	- Contained in xxxx.10.00
				3857.50.00	380 GF2/380	- Contained in xxxx.10.00
2244						
2244,2244 L	08.73 - 09.96	OM 442.951		3887.10.00	380 GF2/380	- This part number includes one clutch disc
2244 S	10.85 - 07.89	OM 442.953 OM 442.980		3891.30.00	380 10 380GS	- Loose clutch disc
				8520.40.00	KZI - 4,5	
				3882.20.00	380 GF2/380	- Contained in xxxx.10.00
				3882.50.00	380 GF2/380	- Contained in xxxx.10.00
				3889.30.00	380 10 380GSZ	- Contained in xxxx.10.00
2327						
2327 L				4300.90.29	430 10	
				4305.20.00	MFZ430	
				4346.30.00	430WGTZ	
				8905.40.00	KZIZ - 5	
2420						
2420,2420 L	12.87 - 09.96	OM 356.984 OM 366.983		3500.90.11	350 10	
				3580.20.00	GMF350	
				3583.30.00	350GSZ	
				8529.40.00	KZI - 4,5	
2422						
2422 653.036, 653.037, 653.038	09.89 - 08.94	OM 441.905		4300.90.18	430 10	
2422,2422 L 653.017, 653.419, 653.417, 652.036, 653.019, 6x2/2/4	12.87 - 09.96	OM 441.912 OM 441.920		4304.20.00	MFZ430	
2422 B 653.076, 653.074	09.89 - 08.94	OM 441.923		4316.30.00	430WGTZ	
2422 K 653.137, 653.138	09.89 - 08.94	OM 441.924		8917.40.00	KZIZ - 5	
2422 L 654.417, 654.416, 654.418, 153kW, 11309cc	12.87 - 09.96					
2422 L 656.009, 160 - 165kW	07.87 - 09.96					
2422 L 654.417, 654.416, 654.418, 160 - 170kW, 10964cc	12.87 - 09.96					
2422 617.024, 617.026, 10964cc	08.73 - 09.96	OM 421.905		4300.90.18	430 10	- Engine code: OM401LA,441
2422 617.024, 617.026, 11309cc	08.73 - 09.96	OM 441.905		4304.20.00	MFZ430	
2422 621.008, 621.006, 621.005, 621.007	10.81 - 10.90	OM 441.914 OM 441.916		4316.30.00	430WGTZ	
2422,2422 L 653.017, 653.419, 653.417, 652.036, 653.019, 6x2	12.87 - 09.96	OM 441.917 OM 441.920		8917.40.00	KZIZ - 5	
2422, 2422 L 652.438, 652.439, 652.036, 151kW, 11309cc	09.89 - 08.94	OM 441.923				
2422, 2422 L 652.438, 652.439, 652.036, 160kW, 10964cc	09.89 - 08.94	OM 441.932				
2422 K 621.107	10.81 - 03.91					

Vehicle list



MERCEDES-BENZ

2425						
2425	04.85 - 03.91	OM 422.909	3831.20.00	380 GF380KR		
			3821.30.00	380 10 380GSZ		
			8500.40.00	KZI - 4,5	- To chassis no.: 5107148	
			8511.40.00	KZI - 4.5	- From chassis no.: 5107149	
2426						
2426, 4x2	12.87 - 09.96	OM 401.973	4300.90.30	430 10		
2426, 6x4	01.90 - 08.94	OM 401.979	4305.20.00	MFZ430		
2426 B	02.90 - 08.94	OM 441.960	4304.30.00	430WGTZ		
2426, 2426 L	02.90 - 08.94	OM 442.909	8917.40.00	KZIZ - 5		
2426 L, 200 - 230kW	02.90 - 08.94	OM 442.914				
2426 L, 250kW	02.90 - 08.94	OM 442.921				
		OM 442.922				
		OM 442.932				
		OM 442.934				
2427						
2427 ,L	12.87 - 09.96	OM 401.973	4300.90.18	430 10		
2427 L		OM 401.977	4304.20.00	MFZ430		
			4316.30.00	430WGTZ		
			8917.40.00	KZIZ - 5		
2427 B	02.90 - 08.94	OM 401.977	4300.90.30	430 10		
	02.90 - 08.94	OM 401.978	4305.20.00	MFZ430		
		OM 442.923	4304.30.00	430WGTZ		
			8917.40.00	KZIZ - 5		
2428						
2428	08.73 - 09.96	OM 422.905	4200.90.16	420 10		
		OM 422.911	4235.20.00	GF420KR		
		OM 422.913	4257.30.00	420GSZ		
		OM 422.916	8500.40.00	KZI - 4,5		
			4225.20.00	420 GF420KR	- For PTO	
			4298.20.00	420 GF420	- For PTO	
2429						
2429 656.016, 656.018, 656.416, 656.015			4300.90.30	430 10		
			4305.20.00	MFZ430		
			4304.30.00	430WGTZ		
			8917.40.00	KZIZ - 5		
			4305.20.00	430 MFZ430		
			4304.30.00	430 10 430WGTZ		
			8905.40.00	KZIZ - 5		
2429 658.033, 658.032	07.88 - 08.94	OM 442.906	4300.90.30	430 10		
2429,2429 L 658.001, 658.006, 658.007, 658.008, 658.009, 658.407, 658.408	07.87 - 09.96	OM 442.907	4305.20.00	MFZ430		
		OM 442.923	4304.30.00	430WGTZ		
2429 K 658.134, 658.132	07.88 - 08.94	OM 442.925	8917.40.00	KZIZ - 5		
2429 S 658.130	07.88 - 08.94		4300.90.28	430 10		
2429 S,2429 LS 657.105, 657.505	07.87 - 09.96		4305.20.00	MFZ430		
			4346.30.00	430WGTZ		
			8905.40.00	KZIZ - 5		

Vehicle list



MERCEDES-BENZ

2429							
2429 422.916	07.87 - 09.96	OM 422.916		3831.20.00	380 GF380KR	- Engine code: OM422	
2429 652.043, 652.045	12.87 - 09.96	OM 442.906		3897.30.00	380 10 380GSZ	- Engine code: OM422	
2429, 2429 L 656.016, 656.018, 655.416, 656.416, 655.418, 656.015	12.87 - 09.96	OM 442.907		8500.40.00	KZI - 4,5	- To chassis no.: 5107148	
	07.87 - 09.96	OM 442.908				- Engine code: OM422	
		OM 442.909				- From chassis no.: 5107149	
		OM 442.923		8511.40.00	KZI - 4.5	- Engine code: OM422	
		OM 442.925					
2431							
2431, 6x2/2/4	12.87 - 09.96	OM 401.972		4300.90.30	430 10		
2431, 4x2	12.87 - 09.96	OM 401.979		4305.20.00	MFZ430		
		OM 401.993		4304.30.00	430WGTZ		
				8917.40.00	KZIZ - 5		
2433							
2433, 243kW, 19t	11.80 - 03.91	OM 422.954		4244.20.00	420 GFX420KR		
2433, 243kW, 24t	10.80 - 09.96	OM 422.957		4260.30.00	420 10 420GSZ		
2433				8513.40.00	KZI - 4.5		
2433,2433 L, 2434 L	12.87 - 09.96	OM 441.960		4300.90.01	430 10		
2433 K	09.89 - 07.92	OM 441.962		4304.20.00	MFZ430		
2433 S,2433 LS	12.87 - 09.96	OM 441.981		4346.30.00	430WGTZ		
		OM 441.983		8905.40.00	KZIZ - 5		
		OM 441.986					
		OM 441.989					
		OM 445.920					
		OM 445.939					
2433 L	12.87 - 09.96	OM 401.979		4300.90.30	430 10		
				4305.20.00	MFZ430		
				4304.30.00	430WGTZ		
				8917.40.00	KZIZ - 5		
2434							
2434 L	07.87 - 09.96	OM 441.986		4300.90.30	430 10		
		OM 441.989		4305.20.00	MFZ430		
				4304.30.00	430WGTZ		
				8917.40.00	KZIZ - 5		
2435							
2435, 250kW	07.87 - 09.96	OM 440.940		4300.90.01	430 10		
2435, 260kW	07.88 - 08.94	OM 440.941		4304.20.00	MFZ430		
2435,2435 L	07.87 - 09.96	OM 440.942		4346.30.00	430WGTZ		
2435 K	07.88 - 08.94	OM 442.942		8905.40.00	KZIZ - 5		
2435 S	07.88 - 08.94	OM 442.943					
2435 S	07.88 - 08.94	OM 442.944					
2435 S,2435 LS	07.87 - 09.96	OM 442.944					
2435 LS	07.87 - 09.96	OM 442.962					
		OM 442.963					
		OM 442.964					
		OM 442.965					
		OM 442.966					
		OM 442.968					
		OM 442.968					
		OM 442.976					

Vehicle list

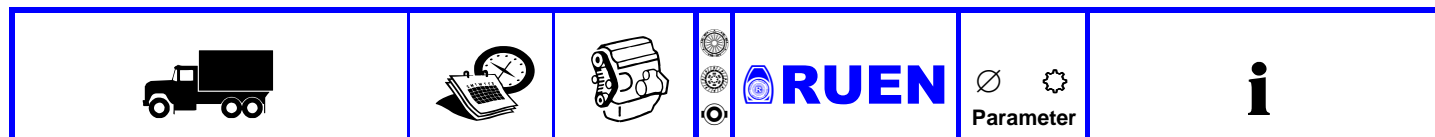

MERCEDES-BENZ

2438

2438 623.068	08.73 - 09.96	OM 422.953		3857.10.00	380 GF2/380	- This part number includes one clutch disc
2438 L 621.085	11.80 - 06.90	OM 422.955 OM 422.959		3892.30.00	380 10 380GSZ	- Loose clutch disc - Contained in xxxx.10.00
				8520.40.00	KZI - 4,5	
				3857.20.00	380 G380KR	- Contained in xxxx.10.00
				3857.50.00	380 GF2/380	- Contained in xxxx.10.00

2448

2448	07.88 - 07.92	OM 442.984		4000.90.03	400 10	- Special design
2448,2448 L	07.87 - 09.96	OM 442.985		4010.10.00	MFZ2/400X	
2448 LS, 353 - 362kW	07.88 - 07.92	OM 442.989		4021.30.00	400GVZ	
2448 S	07.88 - 07.92	OM 442.992		8928.40.00	KZIZ - 5	
				4300.90.07	430 10	
				4307.20.00	MFZ430	
				4346.30.00	430WGTZ	
				8905.40.00	KZIZ - 5	
2448 L	01.88 -			4300.90.07	430 10	
				4307.20.00	MFZ430	
				4346.30.00	430WGTZ	
				8905.40.00	KZIZ - 5	
2448 LS	01.88 -			4000.90.03	400 10	
				4010.10.00	MFZ2/400X	
				4021.30.00	400GVZ	
				8928.40.00	KZIZ - 5	

2522

2522 L, 153kW	12.87 - 09.96	OM 441.905		4300.90.18	430 10	
2522 L, 165kW	12.87 - 09.96	OM 441.920		4304.20.00	MFZ430	
				4316.30.00	430WGTZ	
				8917.40.00	KZIZ - 5	

2524

2524				4300.90.01	430 10	
				4304.20.00	MFZ430	
				4346.30.00	430WGTZ	
				8905.40.00	KZIZ - 5	
2524, 9600cc	06.92 - 09.96	OM 401.975		4300.90.29	430 10	
2524, 10964cc	01.94 - 09.96	OM 445.924		4305.20.00	MFZ430	
2524 K, 9600cc	06.92 - 09.96			4346.30.00	430WGTZ	
2524 K, 10964cc	01.94 - 09.96			8905.40.00	KZIZ - 5	
2524,2524 L, 180kW	12.87 - 09.96	OM 401.973		4300.90.18	430 10	
2524,2524 L, 180 - 200kW	12.87 - 09.96	OM 401.975		4304.20.00	MFZ430	
2524 L, 9572cc	12.87 - 09.96	OM 445.924		4316.30.00	430WGTZ	
2524 L, 10960cc	12.87 - 09.96	OM 445.938 OM 445.941		8917.40.00	KZIZ - 5	
				4300.90.29	430 10	
				4305.20.00	MFZ430	
				4346.30.00	430WGTZ	
				8905.40.00	KZIZ - 5	

Vehicle list

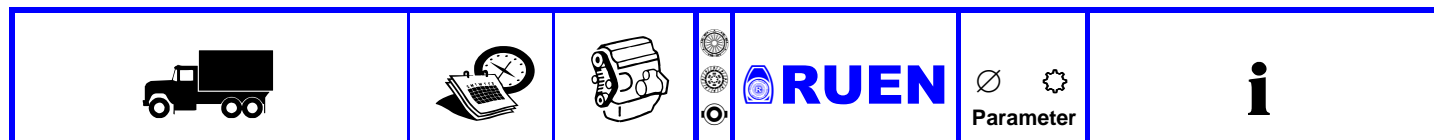

MERCEDES-BENZ

2527

2527, 9572cc 2527, 10964cc 2527 B, 9572cc 2527 B, 10964cc 2527 K, 9572cc 2527 K, 10964cc 2527 L, 200 - 230kW, 10964cc	10.93 - 09.96 01.94 - 09.96 03.91 - 09.96 01.94 - 09.96 10.93 - 09.96 01.94 - 09.96 01.94 - 09.96	OM 401.973 OM 401.978 OM 401.980 OM 445.924 OM 445.926 OM 445.927 OM 445.929 OM 445.936 OM 445.940		4300.90.29 4305.20.00 4346.30.00 8905.40.00	430 10 MFZ430 430WGTZ KZIZ - 5	
2527 L				4300.90.29 4305.20.00 4346.30.00 8905.40.00	430 10 MFZ430 430WGTZ KZIZ - 5	
				4300.90.30 4305.20.00 4304.30.00 8917.40.00	430 10 MFZ430 430WGTZ KZIZ - 5	
2527 L, 200 - 230kW, 9572cc	09.92 - 09.96	OM 401.973 OM 401.975 OM 401.977 OM 401.979		4300.90.18 4304.20.00 4316.30.00 8917.40.00	430 10 MFZ430 430WGTZ KZIZ - 5	
				4300.90.29 4305.20.00 4346.30.00 8905.40.00	430 10 MFZ430 430WGTZ KZIZ - 5	
2527 L, 195kW	03.91 - 08.94	OM 442.914		4300.90.18 4304.20.00 4316.30.00 8917.40.00	430 10 MFZ430 430WGTZ KZIZ - 5	
2527 L, 200kW, 9572cc 2527 L, 200kW, 10964cc	12.87 - 09.96 12.87 - 09.96	OM 401.973 OM 401.977 OM 401.991 OM 445.926 OM 445.936		4300.90.29 4305.20.00 4346.30.00 8905.40.00	430 10 MFZ430 430WGTZ KZIZ - 5	

2528

2528 A 621.215, 621.214 2528 AK 621.316, 621.312, 621.317	01.80 - 03.91 01.80 - 03.91	OM 422.907 OM 422.911 OM 422.913 OM 422.916		4244.30.00	420 10 420/210GSZ	- For PTO
--	--------------------------------	--	--	-------------------	-----------------------------	-----------

2529

2529				4305.20.00	430 MFZ430	
				4304.30.00	430 10 430WGTZ	
				8905.40.00	KZIZ - 5	

Vehicle list



MERCEDES-BENZ

2531						
2531, 10964cc	05.91 - 09.96	OM 401.972		4300.90.01	430 10	
2531, 9572cc	05.91 - 09.96	OM 401.979		4304.20.00	MFZ430	
2531, 2531 L, 9572cc	07.87 - 09.96	OM 401.986		4346.30.00	430WGTZ	
2531, 2531 L, 10964cc	07.87 - 09.96	OM 401.993		8905.40.00	KZIZ - 5	
2531,2531 L, 10964cc	12.87 - 09.96	OM 445.920		4300.90.30	430 10	
2531,2531 L, 9572cc	12.87 - 09.96	OM 445.929		4305.20.00	MFZ430	
2531 B	12.87 - 09.96	OM 445.930		4304.30.00	430WGTZ	
2531 L, 230kW, 10964cc	12.87 - 09.96	OM 445.937		8917.40.00	KZIZ - 5	
2531 L, 230kW, 9572cc, 4x2	12.87 - 09.96			4300.90.18	430 10	
2531 L, 250kW	12.87 - 09.96			4304.20.00	MFZ430	
2531 L, 230kW, 9572cc, 6x2/4	12.87 - 09.96			4316.30.00	430WGTZ	
				8917.40.00	KZIZ - 5	
				4305.20.00	430	
				4306.30.00	MFZ430	
				4306.30.00	430 10	
				4306.30.00	430WGTZ	
				8905.40.00	KZIZ - 5	
2534						
2534,2534 L	12.87 - 09.96	OM 441.986		4300.90.01	430 10	
2534 K	01.91 - 09.96	OM 441.987		4304.20.00	MFZ430	
2534 S,2534 LS	12.87 - 09.96	OM 441.989		4346.30.00	430WGTZ	
		OM 441.991		8905.40.00	KZIZ - 5	
		OM 445.920		4300.90.29	430 10	
		OM 445.921		4305.20.00	MFZ430	
		OM 445.922		4346.30.00	430WGTZ	
				8905.40.00	KZIZ - 5	
2534, 2534 L	07.87 - 09.96	OM 441.986		4300.90.01	430 10	
		OM 441.996		4304.20.00	MFZ430	
		OM 445.920		4346.30.00	430WGTZ	
		OM 445.930		8905.40.00	KZIZ - 5	
		OM 445.939				
2534 L, 250kW	12.87 - 09.96	OM 401.974		4300.90.29	430 10	
2534 L, 230kW	12.87 - 09.96	OM 401.979		4305.20.00	MFZ430	
		OM 445.920		4346.30.00	430WGTZ	
		OM 445.929		8905.40.00	KZIZ - 5	
2535						
2535 L				4300.90.01	430 10	
				4304.20.00	MFZ430	
				4346.30.00	430WGTZ	
				8905.40.00	KZIZ - 5	
2536						
2536 AK 621.327, 260kW, 14618cc	10.81 - 03.91	OM 423.905		4257.30.00	420 10	- For PTO
2536 AK 621.327, 261kW, 18273cc	10.81 - 03.91	OM 423.907			420GSZ	
		OM 442.950				
		OM 442.952				
		OM 442.962				

Vehicle list



MERCEDES-BENZ







2538

2538, 280kW, 12763cc	03.91 - 09.96	OM 402.971		4300.90.01	430 10	
2538, 370kW, 6x2	03.91 - 09.96	OM 402.972		4304.20.00	MFZ430	
2538, 280kW, 14618cc	01.94 - 09.96	OM 402.975		4346.30.00	430WGTZ	
2538, 320kW	03.91 - 09.96	OM 402.985		8905.40.00	KZIZ - 5	
2538, 370kW	03.91 - 09.96	OM 402.986		4000.90.03	400 10	- Vehicles with double disc clutch
2538,2538 L, 280kW, 12763cc	07.87 - 09.96	OM 402.989		4010.10.00	MFZ2/400X	
2538,2538 L, 280kW, 14618cc	07.87 - 09.96	OM 440.970		4021.30.00	400GVZ	
2538,2538 L, 320kW	07.87 - 09.96	OM 440.971		8928.40.00	KZIZ - 5	
2538 K, 2538 LK, 280kW, 12763cc	03.91 - 09.96	OM 440.980		4300.90.07	430 10	- Equipment Var: SA033617-01
2538 K, 2538 LK, 280kW, 14618cc	01.94 - 09.96	OM 440.981		4307.20.00	MFZ430	
2538 K, 2538 LK, 320kW	03.91 - 09.96	OM 442.989		4346.30.00	430WGTZ	
2538 K, 2538 LK, 362kW	03.91 - 09.96	OM 442.997		8905.40.00	KZIZ - 5	
		OM 446.924				
		OM 446.925				
2538 S	03.91 - 09.96	OM 402.971		4300.90.01	430 10	
2538 S,2538 LS, 280kW, 12763cc	07.87 - 09.96	OM 402.972		4304.20.00	MFZ430	
2538 S,2538 LS, 280kW, 14618cc	07.87 - 09.96	OM 402.975		4346.30.00	430WGTZ	
2538 S,2538 LS, 320kW	07.87 - 09.96	OM 402.985		8905.40.00	KZIZ - 5	
		OM 402.986		4300.90.07	430 10	- Equipment Var: SA033617-01
		OM 402.989		4307.20.00	MFZ430	
		OM 402.990		4346.30.00	430WGTZ	
		OM 440.970		8905.40.00	KZIZ - 5	
		OM 440.971		4000.90.03	400 10	- Vehicles with double disc clutch
		OM 440.978		4010.10.00	MFZ2/400X	
		OM 440.980		4021.30.00	400GVZ	
		OM 440.981		8928.40.00	KZIZ - 5	
		OM 446.924				
		OM 446.925				
		OM 446.928				
		OM 446.929				
		OM 446.942				
		OM 446.948				

















































2544

2544, 2544 L	01.92 - 09.96	OM 440.970		4000.90.03	400 10	
2544,2544 L	07.87 - 09.96	OM 440.972		4010.10.00	MFZ2/400X	
2544 S, LS	01.92 - 09.96	OM 440.978		4021.30.00	400GVZ	
		OM 446.922		8928.40.00	KZIZ - 5	
				4300.90.07	430 10	
				4307.20.00	MFZ430	
				4346.30.00	430WGTZ	
				8905.40.00	KZIZ - 5	
2544	01.94 - 09.96	OM 440.970		4300.90.01	430 10	
2544 LS	01.92 - 09.96	OM 440.978		4304.20.00	MFZ430	
2544 S	07.88 - 08.94	OM 446.942		4346.30.00	430WGTZ	
				8905.40.00	KZIZ - 5	
				4300.90.07	430 10	
				4307.20.00	MFZ430	
				4346.30.00	430WGTZ	
				8905.40.00	KZIZ - 5	







Vehicle list

					
---	---	---	--	---	---































MERCEDES-BENZ

2544						
2544 A,K,L,S,LS			 4300.90.01	430 10		
			 4304.20.00	MFZ430		
			 4346.30.00	430WGTZ		
			 8905.40.00	KZIZ - 5		
			 4300.90.07	430 10		
			 4307.20.00	MFZ430		
			 4346.30.00	430WGTZ		
			 8905.40.00	KZIZ - 5		
			 4300.90.30	430 10		
			 4305.20.00	MFZ430		
			 4304.30.00	430WGTZ		
			 8917.40.00	KZIZ - 5		
2550						
2550 2550 K	07.87 - 09.96	OM 440.971 OM 440.981 OM 442.989 OM 442.997	 4300.90.01	430 10		
			 4304.20.00	MFZ430		
			 4346.30.00	430WGTZ		
			 8905.40.00	KZIZ - 5		
			 4300.90.07	430 10		
			 4307.20.00	MFZ430		
			 4346.30.00	430WGTZ		
			 8905.40.00	KZIZ - 5		
2550, 362 - 370kW	07.87 - 09.96	OM 442.989 OM 442.997	 4300.90.01	430 10		
			 4304.20.00	MFZ430		
			 4346.30.00	430WGTZ		
			 8905.40.00	KZIZ - 5		
2550, 370 - 390kW 2550,2550 L	01.91 - 09.96	OM 440.971	 4000.90.03	400 10	- To chassis no.: K011863	
	07.87 - 09.96	OM 440.973	 4010.10.00	MFZ2/400X	- Equipment Var: SA33613-03	
		OM 442.989	 4021.30.00	400GVZ	- Special design	
		OM 442.997	 8928.40.00	KZIZ - 5		
		OM 442.998	 4300.90.07	430 10	- From chassis no.: K011864	
		OM 446.920	 4307.20.00	MFZ430		
			 4346.30.00	430WGTZ		
			 8905.40.00	KZIZ - 5		
2550 S, 2550 LS	01.91 - 09.96	OM 440.971 OM 440.973 OM 442.997 OM 442.998 OM 446.920	 4000.90.03	400 10		
			 4010.10.00	MFZ2/400X		
			 4021.30.00	400GVZ		
			 8928.40.00	KZIZ - 5		
2553						
2553,2553 L 2553 S, 2553 LS	07.87 - 09.96	OM 446.920	 4000.90.01 $\Delta \nabla \text{HD}$	400 10	- To chassis no.: K011863	
	01.96 - 09.96		 4001.10.00	MFZ2/400X	- Equipment Var: SA33613-03	
			 4010.30.00	400WGVZ	- Special design	
			 8916.40.00	KZIZ - 5		
			 4300.90.01	430 10	- From chassis no.: K011864	
			 4304.20.00	MFZ430		
			 4346.30.00	430WGTZ		
			 8905.40.00	KZIZ - 5		
2553 K			 4300.90.01	430 10		
			 4304.20.00	MFZ430		
			 4346.30.00	430WGTZ		
			 8905.40.00	KZIZ - 5		

Vehicle list

					
---	---	---	--	---	---

MERCEDES-BENZ

2553					
2553 LS			 4000.90.03	400 10	
			 4010.10.00  4021.30.00  8928.40.00	MFZ2/400X 400GVZ KZIZ - 5	
			 4300.90.01	430 10	
			 4304.20.00  4346.30.00  8905.40.00	MFZ430 430WGTZ KZIZ - 5	
2620					
2620 L,LA,LB,LAB			 3822.20.00	380	
			 3822.30.00	380 10	
			 8502.40.00	KZI - 4	
2623					
L,LA,LB,LAB,LH,LP 2623			 3822.20.00	380	
			 3822.30.00	380 10	
			 8502.40.00	KZI - 4	
2624					
2624 343 L,LA,LB,LK,LS 2624 343.301, 343.304, 343.134, 343.314, 343.103, 343.303, 343.334, 343.101, 343.114, 343.104 LAB,LAK,LAS 2624 343.301, 343.304, 343.134, 343.314, 343.103, 343.303, 343.334, 343.101, 343.114, 343.104			 3822.20.00	380	
			 3822.30.00	380 10	
			 8502.40.00	KZI - 4	
L,LK,LS 2624			 3821.20.00	380	
			 3821.30.00	380 10	
			 8503.40.00	KZI - 4,5	
L,LA,LAB,LAS 2624 343.301, 343.304, 343.134, 343.314, 343.303, 343.334, 343.101, 343.114, 343.1037104			 3872.30.00	380 10	
L,LK,LS 2624 343.003, 343.004, 343.014, 343.001			 3821.20.00	380	- Engine code: OM355
			 3821.30.00	380 10	- Engine code: OM355
			 8503.40.00	KZI - 4,5	- Engine code: OM355
L 2624 343.001 LA 2624 343.101 LAK 2624 343.103, 343.104 LAS 2624 343.114 LAB 2624 343.134 LB 2624 LK 2624 343.003, 343.004, 343.304, 343.303 LS 2624 343.314, 343.014		OM 355.976 OM 355.960 OM 355.963 OM 355.975 OM 355.981 OM 355.982 OM 355.983 OM 355.984	 3821.20.00	380	- Engine code: OM355
			 3821.30.00	380 10	- Engine code: OM355
			 8503.40.00	KZI - 4,5	- Engine code: OM355
			 3822.20.00	380	- Engine code: OM355
			 3822.30.00	380 10	- Engine code: OM355
			 8502.40.00	KZI - 4	- Engine code: OM355

Vehicle list



MERCEDES-BENZ

2626

2626 2626 K 2626 S	06.75 - 03.81	OM 402.906		3821.20.00	380 GF380KR	
	08.73 - 03.81	OM 402.912		3821.30.00	380 10 380GSZ	
	06.75 - 03.81	OM 402.916		4226.20.00	420 GF420KR	
				4234.20.00	420 GF420KR	
				4297.30.00	420 10 420GSZ	
					8500.40.00	KZI - 4,5
2626 A 2626 AK 2626 AS	06.75 - 03.81	OM 402.906		3821.20.00	380 GF380KR	
	08.73 - 12.81	OM 402.912		3821.30.00	380 10 380GSZ	
	06.75 - 03.81	OM 402.916		4226.20.00	420 GF420KR	
				4234.20.00	420 GF420KR	
				4297.30.00	420 10 420GSZ	
					8500.40.00	KZI - 4,5
2626 AB	05.74 - 12.80	OM 402.906		3821.20.00	380 GF380KR	- To chassis no.: 4372223
		OM 402.912		3821.30.00	380 10 380GSZ	- To chassis no.: 4372223
		OM 402.926		8500.40.00	KZI - 4,5	- To chassis no.: 4372223 - From chassis no.: 4372224
				4226.20.00	420 GF420KR	- From chassis no.: 4372224
				4234.20.00	420 GF420KR	- From chassis no.: 4372224
				4297.30.00	420 10 420GSZ	- From chassis no.: 4372224
2626 B	05.74 - 12.80	OM 402.906		3821.20.00	380 GF380KR	- To chassis no.: 4372223
		OM 402.912		3821.30.00	380 10 380GSZ	- To chassis no.: 4372223
		OM 402.926		8500.40.00	KZI - 4,5	- To chassis no.: 4372223 - From chassis no.: 4372224
				4226.20.00	420 GF420KR	- From chassis no.: 4372224
				4234.20.00	420 GF420KR	- From chassis no.: 4372224
				4297.30.00	420 10 420GSZ	- From chassis no.: 4372224

2628

2628 623.007, 624.033, 623.009, 624.032 2628 A 624.232, 624.233, 624.203 2628 AS 624.331 2628 B 624.030 2628 K 624.132, 624.134 2628 S 624.131	02.80 - 03.91	OM 422.905		4200.90.16	420 10 GF420KR	
	02.80 - 03.91	OM 422.907		4235.20.00	420GSZ	
	02.80 - 03.91	OM 422.911		4257.30.00	KZI - 4,5	
	02.80 - 03.91	OM 422.913		8500.40.00		
	02.80 - 08.89	OM 422.916		4225.20.00	420 GF420KR	
	02.80 - 03.91				4298.30.00	420 10 420GSZ
				4244.30.00	420 10 420/210GSZ	- For PTO
				4258.30.00	420 10 420GSZ	

Vehicle list



MERCEDES-BENZ

2628

2628 AK 624.333, 624.334	02.80 - 03.91	OM 422.913	4200.90.16	420 10	
			4235.20.00	GF420KR	
			4257.30.00	420GSZ	
			8500.40.00	KZI - 4,5	
			4225.20.00	420	
				GF420KR	
			3857.10.00	380	- This part number includes one clutch disc
				GF2/380	
L,LK,LS 2628 343.033, 343.034, 343.031, 343.044			4200.90.16	420 10	
			4235.20.00	GF420KR	
			4257.30.00	420GSZ	
			8500.40.00	KZI - 4,5	
			4225.20.00	420	
				GF420KR	
			3871.30.00	380 10	- GBox: ZF 16S-160
				380/70GSZ	- For PTO
2628 A 624.233	01.90 - 03.91	OM 443.940	4200.90.17	420 10	
			4235.20.00	GF420KR	
			4258.30.00	420GSZ	
			8500.40.00	KZI - 4,5	
			4300.90.30	430 10	
				MFZ430	
			4304.30.00	430WGTZ	
			8917.40.00	KZIZ - 5	
L 2628 343.031 LK 2628 343.033, 343.034 LS 2628 343.044		OM 355.969	4300.90.28	430 10	- Special design
			4305.20.00	MFZ430	
			4346.30.00	430WGTZ	
			8905.40.00	KZIZ - 5	
			4300.90.01	430 10	- Special design
			4304.20.00	MFZ430	
			4346.30.00	430WGTZ	
			8905.40.00	KZIZ - 5	
			4300.90.01	430 10	- Special design
			4304.20.00	MFZ430	
4346.30.00	430WGTZ				
8905.40.00	KZIZ - 5				

2629

2629 659.033, 659.032, 213 - 218kW 2629 659.032, 269kW 2629 A 659.232, 659.233, 213 - 218kW 2629 A 659.232, 659.233, 269kW 2629 A 659.233, 280kW 2629 A 659.233, 320kW 2629 A 659.233, 340kW 2629 A 659.232, 659.233, 362 - 370kW	07.88 - 08.94	OM 402.982	4300.90.30	430 10	
		OM 440.970	4305.20.00	MFZ430	
		OM 440.971	4304.30.00	430WGTZ	
		OM 442.906	8917.40.00	KZIZ - 5	
		OM 442.907	4300.90.28	430 10	- Special design
		OM 442.917	4305.20.00	MFZ430	
		OM 442.925	4346.30.00	430WGTZ	
		OM 442.926	8905.40.00	KZIZ - 5	
		OM 442.929	4300.90.01	430 10	- Special design
		OM 442.942	4304.20.00	MFZ430	
OM 442.959	4346.30.00	430WGTZ			
OM 442.966	8905.40.00	KZIZ - 5			
OM 442.989	4300.90.01	430 10	- Special design		
OM 442.997	4304.20.00	MFZ430			
OM 443.940	4346.30.00	430WGTZ			
8905.40.00	KZIZ - 5				
2629 AK 659.334, 659.333, 213kW 2629 AK 659.333, 269kW 2629 AK 659.333, 320kW 2629 AK 659.334, 362kW	07.88 - 08.94	OM 440.970	4300.90.30	430 10	
		OM 440.971	4305.20.00	MFZ430	
		OM 442.907	4304.30.00	430WGTZ	
		OM 442.926	8917.40.00	KZIZ - 5	
		OM 442.942	4300.90.01	430 10	- Special design
		OM 442.959	4304.20.00	MFZ430	
		OM 442.966	4346.30.00	430WGTZ	
		OM 442.989	8905.40.00	KZIZ - 5	
		OM 442.997	4300.90.28	430 10	
			4305.20.00	MFZ430	
	4346.30.00	430WGTZ			
	8905.40.00	KZIZ - 5			

Vehicle list

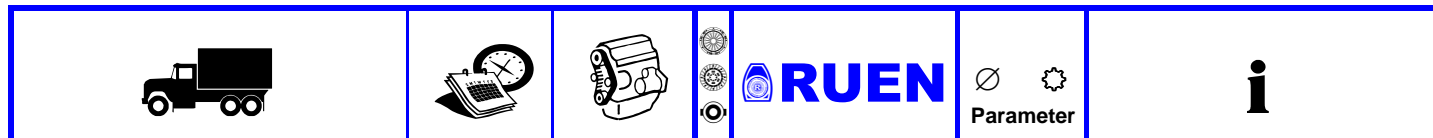













































MERCEDES-BENZ

2629						
2629 AS 659.331, 213 - 218kW	07.88 - 08.94	OM 442.906		4300.90.30	430 10	
2629 AS 659.331, 362 - 370kW	07.88 - 08.94	OM 442.907		4305.20.00	MFZ430	
2629 B 659.030, 213 - 218kW	07.88 - 08.94	OM 442.917		4304.30.00	430WGTZ	
		OM 442.925		8917.40.00	KZIZ - 5	
		OM 442.926		4300.90.28	430 10	- Special design
		OM 442.929		4305.20.00	MFZ430	
		OM 442.989		4346.30.00	430WGTZ	
		OM 442.997		8905.40.00	KZIZ - 5	
				4300.90.01	430 10	
				4304.20.00	MFZ430	
				4346.30.00	430WGTZ	
				8905.40.00	KZIZ - 5	
2629 K 659.134, 659.132, 213kW, 15080cc	07.88 - 08.94	OM 401.979		4300.90.30	430 10	- Engine code: OM442
2629 K 659.134, 230kW, 9572cc	07.88 - 08.94	OM 442.906		4305.20.00	MFZ430	
2629 K 659.134, 362kW, 14618cc	07.88 - 08.94	OM 442.907		4304.30.00	430WGTZ	
2629 S 659.131	07.88 - 08.94	OM 442.917		8917.40.00	KZIZ - 5	
		OM 442.925		4300.90.28	430 10	- Engine code: OM442
		OM 442.926		4305.20.00	MFZ430	- Special design
		OM 442.929		4346.30.00	430WGTZ	
		OM 442.989		8905.40.00	KZIZ - 5	
				4300.90.01	430 10	- Engine code: OM442
				4304.20.00	MFZ430	- Special design
				4346.30.00	430WGTZ	
				8905.40.00	KZIZ - 5	
2631						
2631 659.101, 659.104, 659.102, 659.000, 659.003, 659.002, 230kW	06.92 - 09.96	OM 401.972		4300.90.01	430 10	
2631 659.101, 659.104, 659.102, 659.000, 659.003, 659.002, 230 - 250kW	06.92 - 09.96	OM 401.979		4304.20.00	MFZ430	
		OM 401.981		4346.30.00	430WGTZ	
		OM 401.987		8905.40.00	KZIZ - 5	
		OM 401.993				
		OM 441.998				
		OM 445.920				
		OM 445.929				
		OM 445.930				
		OM 445.931				
2631 K 659.104, 659.134, 10964cc	07.88 - 08.94	OM 441.998		4300.90.01	430 10	
		OM 445.929		4304.20.00	MFZ430	
				4346.30.00	430WGTZ	
				8905.40.00	KZIZ - 5	
2631 A 659.203	06.92 - 09.96	OM 401.972		4300.90.01	430 10	- Engine code: OM401,441
2631 A 659.203	01.94 - 09.96	OM 401.979		4304.20.00	MFZ430	
2631 AK, 2634 AK 659.303, 659.304	06.92 - 09.96	OM 401.981		4346.30.00	430WGTZ	
	01.94 - 09.96	OM 401.986		8905.40.00	KZIZ - 5	
2631 AS 659.301	06.92 - 09.96	OM 401.987		3891.30.00	380 10	- Engine code: OM401
2631 B 659.000	06.92 - 09.96	OM 401.993			380GS	- For PTO
2631 K 659.104, 659.134, 9572cc	07.88 - 08.94	OM 441.998				- Loose clutch disc
2631 S 659.101, 9572cc	06.92 - 09.96	OM 445.929		9302.40.00	KZI-6	- Engine code: OM401
2631 S 659.101, 10964cc	06.92 - 09.96	OM 445.930				- For PTO
	06.92 - 09.96	OM 445.931		3854.30.00	380 10	- Engine code: OM401
					380GVZ	

Vehicle list

					
---	---	---	--	---	---

MERCEDES-BENZ

2632						
2632	05.74 - 09.83	OM 403.916		4200.90.16	420 10	
2632 A	05.74 - 09.83	OM 403.931		4235.20.00	GF420KR	
2632 AK	08.73 - 09.83	OM 403.932		4257.30.00	420GSZ	
2632 AS	05.74 - 09.83	OM 403.935		8500.40.00	KZI - 4,5	
2632 K	08.73 - 09.83			4225.20.00	420	
2632 S	05.74 - 09.83			4250.20.00	GF420KR	- Special design
				4257.30.00	420 10	- Special design
				8500.40.00	420GSZ	- Special design
				8500.40.00	KZI - 4,5	- Special design
2633						
2633	05.82 - 05.87	OM 422.952		4244.20.00	420	
2633 S	05.82 - 05.87	OM 422.954		4260.30.00	GF420KR	
		OM 422.956		8513.40.00	420 10	
		OM 422.957		4287.30.00	420GSZ	
				3857.10.00	KZI - 4.5	
				3892.30.00	420 10	- For PTO
				8520.40.00	420GVZ	
				3857.20.00	380	- This part number includes one clutch disc
				3857.50.00	GF2/380	
				3892.30.00	380 10	- Loose clutch disc
				8520.40.00	380GSZ	- Contained in xxxx.10.00
				3857.20.00	KZI - 4,5	
				3857.20.00	380	- Contained in xxxx.10.00
				3857.50.00	G380KR	- Contained in xxxx.10.00
				3857.50.00	380	- Contained in xxxx.10.00
				3857.50.00	GF2/380	
2634						
2634	06.92 - 09.96	OM 441.986		4300.90.01	430 10	
2634 S	06.92 - 09.96	OM 445.920		4304.20.00	MFZ430	
				4346.30.00	430WGTZ	
				8905.40.00	KZIZ - 5	
2635						
2635, 210kW	07.88 - 08.94	OM 442.909		4000.90.03	400 10	- To chassis no.: K011863
2635, 260kW	07.88 - 08.94	OM 442.923		4010.10.00	MFZ2/400X	
2635, 370kW	01.91 - 08.94	OM 442.944		4021.30.00	400GVZ	
		OM 442.964		8928.40.00	KZIZ - 5	
		OM 442.966		4300.90.07	430 10	- From chassis no.: K011864
		OM 442.976		4307.20.00	MFZ430	
		OM 442.997		4346.30.00	430WGTZ	
				8905.40.00	KZIZ - 5	
				4300.90.01	430 10	
				4304.20.00	MFZ430	
				4346.30.00	430WGTZ	
				8905.40.00	KZIZ - 5	
2635, 260kW	04.86 - 03.91	OM 442.950		3882.10.00	380	- This part number includes one clutch disc
2635 A, 269kW	09.87 - 03.91	OM 442.952		3855.30.00	GF2/380	
2635 AK, 269kW	09.87 - 03.91	OM 442.962		3882.20.00	380 10	- Loose clutch disc
2635 AS, 269kW	09.87 - 03.91			8520.40.00	380GS	
2635 S, 260kW	04.86 - 03.91			3882.20.00	KZI - 4,5	
				3882.20.00	380	- Contained in xxxx.10.00
				3882.50.00	GF2/380	- Contained in xxxx.10.00
				3882.50.00	380	- Contained in xxxx.10.00
				3883.30.00	GF2/380	- Contained in xxxx.10.00
				3883.30.00	380 10	- Contained in xxxx.10.00
				3883.30.00	380GSZ	

Vehicle list

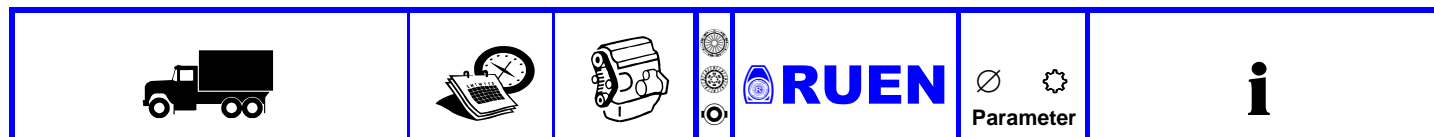

MERCEDES-BENZ

2635

2635 A, 260kW	02.90 - 08.94	OM 402.971		4300.90.01	430 10	
2635 A, 320kW	12.91 - 08.94	OM 440.940		4304.20.00	MFZ430	
2635 AK, 250kW	02.90 - 08.94	OM 440.941		4346.30.00	430WGTZ	
2635 AK, 362kW	02.90 - 08.94	OM 440.942		8905.40.00	KZIZ - 5	
2635 AS, 250kW	02.92 - 08.94	OM 440.970		4000.90.03	400 10	- Vehicles with double disc clutch
2635 AS, 362kW	02.90 - 09.96	OM 440.971		4010.10.00	MFZ2/400X	
2635 K, 250kW	07.88 - 08.94	OM 440.973		4021.30.00	400GVZ	
2635 K, 280kW	01.91 - 08.94	OM 442.942		8928.40.00	KZIZ - 5	
2635 K, 320kW	07.91 - 08.94	OM 442.944				
2635 K, 362kW	07.88 - 08.94	OM 442.964				
2635 S, 250kW	07.88 - 08.94	OM 442.966				
2635 S, 362kW	07.88 - 08.94	OM 442.972				
		OM 442.989				
		OM 442.994				
		OM 442.997				
2635 ,AK,L				4300.90.30	430 10	
				4305.20.00	MFZ430	
				4304.30.00	430WGTZ	
				8917.40.00	KZIZ - 5	
				4300.90.01	430 10	
				4304.20.00	MFZ430	
				4346.30.00	430WGTZ	
				8905.40.00	KZIZ - 5	

2636

2636	11.81 - 03.91	OM 423.905		4244.20.00	420	
2636 A	11.81 - 03.91	OM 423.907		4260.30.00	GFX420KR	
2636 AK	11.81 - 03.91			4260.30.00	420 10	
2636 AS	11.81 - 03.91			4260.30.00	420GSZ	
2636 K	11.81 - 03.91			8513.40.00	KZI - 4.5	
2636 S	11.81 - 03.91			4287.30.00	420 10	- For PTO
				4287.30.00	420GVZ	
				3857.10.00	380	- This part number includes one clutch disc
				3857.10.00	GF2/380	
				3892.30.00	380 10	- Loose clutch disc
				3892.30.00	380GSZ	- Contained in xxxx.10.00
				8520.40.00	KZI - 4,5	
				3857.20.00	380	- Contained in xxxx.10.00
				3857.20.00	G380KR	
				3857.50.00	380	- Contained in xxxx.10.00
				3857.50.00	GF2/380	

2637

2637				4300.90.01	430 10	
				4304.20.00	MFZ430	
				4346.30.00	430WGTZ	
				8905.40.00	KZIZ - 5	
				4000.90.03	400 10	
				4010.10.00	MFZ2/400X	
				4021.30.00	400GVZ	
				8928.40.00	KZIZ - 5	
				4300.90.07	430 10	
				4307.20.00	MFZ430	
				4346.30.00	430WGTZ	
				8905.40.00	KZIZ - 5	

Vehicle list



MERCEDES-BENZ

2638

2638, 2638 L, 280kW, 12763cc	09.91 - 09.96	OM 402.971		4300.90.01	430 10	
2638, 2638 L., 280kW, 14618cc	09.91 - 09.96	OM 402.972		4304.20.00	MFZ430	
2638, 2638 L, 320kW	09.91 - 09.96	OM 402.975		4346.30.00	430WGTZ	
2638, 2638 L, 370kW	09.91 - 09.96	OM 402.978		8905.40.00	KZIZ - 5	
2638 AK, 370kW	09.91 - 09.96	OM 402.985		4300.90.07	430 10	- Equipment Var: SA033617-01
2638 AS, 280kW, 12763cc	07.92 - 09.96	OM 402.986		4307.20.00	MFZ430	
2638 AS, 280kW, 14618cc	01.94 - 09.96	OM 402.996		4346.30.00	430WGTZ	
2638 AS, 320kW	07.92 - 09.96	OM 440.970		8905.40.00	KZIZ - 5	
2638 AS, 370kW	07.92 - 09.96	OM 440.978		4000.90.03	400 10	- Vehicles with double disc clutch
2638 K, 280kW, 12763cc	09.91 - 09.96	OM 440.979		4010.10.00	MFZ2/400X	- Special design
2638 K, 280kW, 14618cc	09.91 - 09.96	OM 440.981		4021.30.00	400GVZ	
2638 K, 320kW	09.91 - 09.96	OM 440.982		8928.40.00	KZIZ - 5	
2638 K, 362kW	09.91 - 09.96	OM 440.990				
2638 K, 370kW	09.91 - 09.96	OM 442.989				
2638 K, 370kW	09.91 - 09.96	OM 442.997				
2638 S, 320kW	09.91 - 09.96	OM 442.997				
2638 S, 370kW	09.91 - 09.96	OM 446.924				
2638 AK, 280kW, 12763cc	09.91 - 09.96	OM 446.925				
2638 AK, 280kW, 14618cc	07.92 - 09.96	OM 446.926				
2638 AK, 280kW, 14618cc	01.94 - 09.96	OM 446.927				
2638 AK, 320kW, 14618cc	07.92 - 09.96	OM 446.936				
2638 A, LA, 280kW, 12763cc	09.91 - 09.96	OM 402.975		4300.90.01	430 10	
2638 A, LA, 280kW, 14618cc	09.91 - 09.96	OM 402.978		4304.20.00	MFZ430	
		OM 402.996		4346.30.00	430WGTZ	
		OM 446.927		8905.40.00	KZIZ - 5	
				4000.90.03	400 10	- Vehicles with double disc clutch
				4010.10.00	MFZ2/400X	
				4021.30.00	400GVZ	
				8928.40.00	KZIZ - 5	
2638 A, LA, 320kW	09.91 - 09.96	OM 440.970		4000.90.03	400 10	- Vehicles with double disc clutch
		OM 440.979		4010.10.00	MFZ2/400X	
				4021.30.00	400GVZ	
				8928.40.00	KZIZ - 5	
2638 S	01.81 - 12.86	OM 422.953		3857.10.00	380	- This part number includes one clutch disc
2638	01.81 - 12.86	OM 422.955		3892.30.00	380 10	- Loose clutch disc
		OM 422.959		8520.40.00	380GSZ	- Contained in xxxx.10.00
				3857.20.00	380	- Contained in xxxx.10.00
				3857.50.00	G380KR	- Contained in xxxx.10.00
					380	- Contained in xxxx.10.00
					GF2/380	
2638, L, LK, LS				8922.40.00	KZISZ-5	

2644

2644, 2644 L	01.92 - 09.96	OM 440.970		4000.90.03	400 10	- To chassis no.: K011863
2644 S	01.92 - 09.96	OM 440.978		4010.10.00	MFZ2/400X	
		OM 446.922		4021.30.00	400GVZ	
				8928.40.00	KZIZ - 5	
				4300.90.07	430 10	- From chassis no.: K011864
				4307.20.00	MFZ430	
				4346.30.00	430WGTZ	
				8905.40.00	KZIZ - 5	

Vehicle list

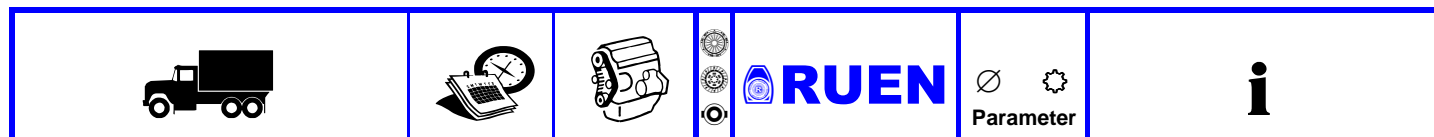

MERCEDES-BENZ

2644

2644 ,K,AK 2644 A	01.92 - 09.96	OM 440.970 OM 440.979 OM 446.936	4300.90.01	430 10	
			4304.20.00 4346.30.00 8905.40.00	MFZ430 430WGTZ KZIZ - 5	
			4300.90.07	430 10	- Equipment Var: SA033617-01
			4307.20.00 4346.30.00 8905.40.00	MFZ430 430WGTZ KZIZ - 5	
			4000.90.03	400 10	- Vehicles with double disc clutch
			4010.10.00 4021.30.00 8928.40.00	MFZ2/400X 400GVZ KZIZ - 5	
2644 AK			4300.90.01	430 10	
			4304.20.00 4346.30.00 8905.40.00	MFZ430 430WGTZ KZIZ - 5	
			4000.90.03	400 10	- Vehicles with double disc clutch
			4010.10.00 4021.30.00 8928.40.00	MFZ2/400X 400GVZ KZIZ - 5	
2644 AK			4300.90.30	430 10	
			4305.20.00 4304.30.00 8917.40.00	MFZ430 430WGTZ KZIZ - 5	
			4300.90.01	430 10	- Special design
			4304.20.00 4346.30.00 8905.40.00	MFZ430 430WGTZ KZIZ - 5	
2644 S	10.85 - 02.90	OM 442.953 OM 442.980	3893.10.00	380	- This part number includes one clutch disc
			38125.30.00	380 10	- Loose clutch disc
			8520.40.00	KZI - 4,5	
			3882.20.00	380	- To chassis no.: K011863
			3882.50.00	380	- To chassis no.: K011863
			3892.30.00	380 10	- Contained in xxxx.10.00
			GF2/380	380GS	







2645

2645 AS	02.90 - 09.96	OM 442.989	4300.90.01	430 10	
			4304.20.00 4346.30.00 8905.40.00	MFZ430 430WGTZ KZIZ - 5	



















































2648

2648 AK	02.90 - 08.94	OM 440.973 OM 442.989	4300.90.01	430 10	
			4304.20.00 4346.30.00 8905.40.00	MFZ430 430WGTZ KZIZ - 5	
2648 AS 2648 K,AS	07.88 - 08.94	OM 442.989 OM 442.997	4300.90.30	430 10	
			4305.20.00 4304.30.00 8917.40.00	MFZ430 430WGTZ KZIZ - 5	







Vehicle list

					
---	---	---	--	---	---































MERCEDES-BENZ

2648					
2648 S, 329kW 2648 S, 353 - 362kW 2648 S,LS	12.88 - 07.92	OM 442.983	 4000.90.03	400 10	- To chassis no.: K011863
	12.88 - 07.92	OM 442.985 OM 442.989 OM 442.992 OM 442.994	 4010.10.00  4021.30.00  8928.40.00	MFZ2/400X 400GVZ KZIZ - 5	
			 4300.90.07	430 10	- From chassis no.: K011864
			 4307.20.00  4346.30.00  8905.40.00	MFZ430 430WGTZ KZIZ - 5	
2648 S,AS,AK			 4300.90.01	430 10	
			 4304.20.00  4346.30.00  8905.40.00	MFZ430 430WGTZ KZIZ - 5	
2650					
2650, 2650 L 655.496, 659.028, 659.144, 659.098, 659.142 2650 S 659.196	07.92 - 09.96	OM 440.971	 4000.90.03	400 10	- To chassis no.: K011863
	07.92 - 09.96	OM 440.973 OM 440.981 OM 442.989 OM 442.997	 4010.10.00  4021.30.00  8928.40.00	MFZ2/400X 400GVZ KZIZ - 5	
			 4300.90.07	430 10	- From chassis no.: K011864
			 4307.20.00  4346.30.00  8905.40.00	MFZ430 430WGTZ KZIZ - 5	
2650 ,K,S,AK 659.136, 625.197, 659.144, 659.139, 659.142, 659.339			 4300.90.01	430 10	
			 4304.20.00  4346.30.00  8905.40.00	MFZ430 430WGTZ KZIZ - 5	
			 4300.90.07	430 10	- Equipment Var: SA033617-01
			 4307.20.00  4346.30.00  8905.40.00	MFZ430 430WGTZ KZIZ - 5	
2650 A,AS			 4300.90.30	430 10	
			 4305.20.00  4304.30.00  8917.40.00	MFZ430 430WGTZ KZIZ - 5	
			 4300.90.01	430 10	- Special design
			 4304.20.00  4346.30.00  8905.40.00	MFZ430 430WGTZ KZIZ - 5	
2650 K 659.139	07.88 - 08.94	OM 442.989 OM 442.994 OM 442.997	 4000.90.03	400 10	
			 4010.10.00  4021.30.00  8928.40.00	MFZ2/400X 400GVZ KZIZ - 5	
			 4300.90.07	430 10	
			 4307.20.00  4346.30.00  8905.40.00	MFZ430 430WGTZ KZIZ - 5	
2650 A 659.203 2650 AK 659.343, 659.334, 659.339 2650 AS 659.341, 659.334	07.87 - 09.96	OM 440.971	 4000.90.03	400 10	- To chassis no.: K011863
	07.88 - 08.94	OM 440.982	 4010.10.00	MFZ2/400X	- Engine code: OM440
	01.94 - 09.96	OM 442.989 OM 442.997	 4021.30.00  8928.40.00	400GVZ KZIZ - 5	- Engine code: OM442LA
			 4300.90.07	430 10	- From chassis no.: K011864
			 4307.20.00 4346.30.00 8905.40.00	MFZ430 430WGTZ KZIZ - 5	- Engine code: OM440

Vehicle list

					
---	---	---	--	---	---

MERCEDES-BENZ

2650						
2650 656.215			 3891.30.00	380 10 380GS	- Loose clutch disc	
			 9302.40.00	KZI-6		
			 3854.30.00	380 10 380GVZ		
2653						
2653 AK,K,S			 4300.90.01	430 10		
			 4304.20.00	MFZ430		
			 4346.30.00	430WGTZ		
			 8905.40.00	KZIZ - 5		
			 4000.90.03	400 10	- Vehicles with double disc clutch	
 4010.10.00	MFZ2/400X					
 4021.30.00	400GVZ					
 8928.40.00	KZIZ - 5					
3025						
3025 B 3025 K	12.85 - 07.87 12.85 - 07.87	OM 422.919 OM 422.920 OM 442.920	 4200.90.16	420 10		
			 4235.20.00	GF420KR		
			 4257.30.00	420GSZ		
 8500.40.00	KZI - 4,5					
 4225.20.00	420 GF420KR					
3028						
3028 B 3028 K	12.85 - 07.87 12.85 - 07.87	OM 422.919	 4200.90.16	420 10		
			 4235.20.00	GF420KR		
			 4257.30.00	420GSZ		
 8500.40.00	KZI - 4,5					
 4225.20.00	420 GF420KR					
3028	02.80 - 03.91	OM 422.905 OM 422.911	 4200.90.16	420 10		
			 4235.20.00	GF420KR		
			 4257.30.00	420GSZ		
 8500.40.00	KZI - 4,5					
 4225.20.00	420 GF420KR					
3033						
3033	05.82 - 05.87	OM 422.954 OM 422.957	 4244.20.00	420 GFX420KR		
			 4260.30.00	420 10 420GSZ		
			 8513.40.00	KZI - 4.5		
3035						
3035 K 648.038			 3891.30.00	380 10 380GS	- For PTO	

Vehicle list



MERCEDES-BENZ

3036

3036 K 3036	11.81 - 03.91	OM 423.905 OM 423.908	4244.20.00	420 GFX420KR	
			4260.30.00	420 10 420GSZ	
			8513.40.00	KZI - 4,5	
			3857.10.00	380 GF2/380	- This part number includes one clutch disc
			3892.30.00	380 10 380GSZ	- Loose clutch disc - Contained in xxxx.10.00
			8520.40.00	KZI - 4,5	
			3857.20.00	380 G380KR	- Contained in xxxx.10.00
			3857.50.00	380 GF2/380	- Contained in xxxx.10.00

3038

3038	01.81 - 12.86	OM 422.953 OM 422.955 OM 422.959	3857.10.00	380 GF2/380	- This part number includes one clutch disc
			3892.30.00	380 10 380GSZ	- Loose clutch disc - Contained in xxxx.10.00
			8520.40.00	KZI - 4,5	
			3857.20.00	380 G380KR	- Contained in xxxx.10.00
			3857.50.00	380 GF2/380	- Contained in xxxx.10.00

3050

3050 3050 ,S 3053 S	01.94 - 09.96	OM 440.976 OM 446.933	4300.90.01	430 10		
			4304.20.00	MFZ430		
	12.93 - 09.96			4346.30.00	430WGTZ	
				8905.40.00	KZIZ - 5	

3053

3053 ,A			4300.90.01	430 10	
			4304.20.00	MFZ430	
			4346.30.00	430WGTZ	
			8905.40.00	KZIZ - 5	

3228

3228 B 3228 K	07.87 - 03.91	OM 422.919 OM 422.921	4200.90.16	420 10		
			4235.20.00	GF420KR		
	07.87 - 03.91			4257.30.00	420GSZ	
				8500.40.00	KZI - 4,5	
			4225.20.00	420 GF420KR		

3229

3229 3229 B 3229 K	09.89 - 08.94	OM 442.915 OM 442.916	4300.90.30	430 10		
			4305.20.00	MFZ430		
	09.89 - 07.92	OM 442.923 OM 442.927 OM 442.928		4304.30.00	430WGTZ	
				8917.40.00	KZIZ - 5	























3231

3231 L, 9572cc 3231 L, 10964cc	12.87 - 09.96	OM 401.972 OM 401.979	4300.90.01	430 10		
			4304.20.00	MFZ430		
	12.87 - 09.96	OM 401.993 OM 445.929		4346.30.00	430WGTZ	
				8905.40.00	KZIZ - 5	

Vehicle list

					
---	---	---	--	---	---

MERCEDES-BENZ

3233					
3233 ,B			 4200.90.16  4235.20.00  4257.30.00  8500.40.00	420 10 GF420KR 420GSZ KZI - 4,5	
			 4225.20.00	420 GF420KR	
3233 B	10.90 - 07.92	OM 441.982	 4300.90.01	430 10 MFZ430 430WGTZ KZIZ - 5	
3233 K	10.90 - 07.92	OM 441.985	 4304.20.00  4346.30.00  8905.40.00		
3234					
3234 B	02.92 - 09.96	OM 441.988	 4300.90.01	430 10 MFZ430 430WGTZ KZIZ - 5	
3234 K	02.92 - 09.96	OM 441.990 OM 441.992 OM 445.922	 4304.20.00  4346.30.00  8905.40.00		
3235					
3235, 260kW, 32t	10.88 - 07.92	OM 442.944 OM 442.959 OM 442.963 OM 442.976	 4300.90.01	430 10 MFZ430 430WGTZ KZIZ - 5	
			 4000.90.03	400 10 MFZ2/400X 400GVZ KZIZ - 5	- Special design
3235, 260 - 269kW	07.88 - 08.94	OM 442.944	 4300.90.01	430 10 MFZ430 430WGTZ KZIZ - 5	
3235, 260kW, 24t	07.88 - 08.94	OM 442.963	 4304.20.00  4346.30.00  8905.40.00		
3235 L	07.87 - 09.96	OM 442.976			
3235 K	07.87 - 07.92	OM 442.950 OM 442.952 OM 442.959	 4300.90.01	430 10 MFZ430 430WGTZ KZIZ - 5	- To model year: 01.1988
			 4000.90.03	400 10 MFZ2/400X 400GVZ KZIZ - 5	- From model year: 01.1988 - Special design
			 4200.90.16	420 10 GF420KR 420GSZ KZI - 4,5	
			 4225.20.00	420 GF420KR	

Vehicle list

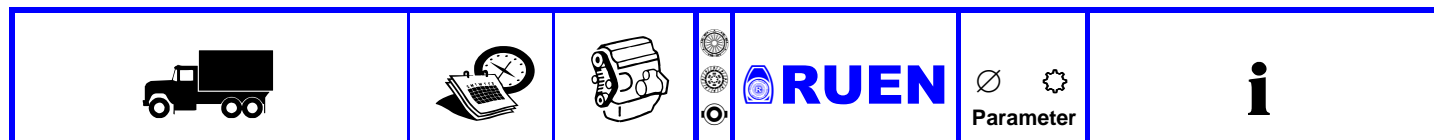

MERCEDES-BENZ

3238

3238, 261kW 3238, 280kW, 12763cc 3238, 280kW, 12763cc, 6x4 3238, 280kW, 14618cc 3238, 362 - 370kW 3238, 3238 L 625.130, 625.132, 625.131, 658.024, 280kW 3238, 3238 L 625.130, 625.132, 625.131, 320kW	03.91 - 09.96	OM 402.971		4300.90.01	430 10	
	10.90 - 09.96	OM 402.973		4304.20.00	MFZ430	
	03.91 - 09.96	OM 402.975		4346.30.00	430WGTZ	
	03.91 - 09.96	OM 402.977		8905.40.00	KZIZ - 5	
	10.90 - 09.96	OM 402.982		4300.90.07	430 10	- Equipment Var: SA033617-01
	01.94 - 09.96	OM 402.985		4307.20.00	MFZ430	
	10.90 - 09.96	OM 402.987		4346.30.00	430WGTZ	
		OM 423.905		8905.40.00	KZIZ - 5	
		OM 423.907		4000.90.03	400 10	- Vehicles with double disc clutch
		OM 440.970		4010.10.00	MFZ2/400X	- Special design
OM 440.971			4021.30.00	400GVZ		
OM 440.980			8928.40.00	KZIZ - 5		
OM 442.989						
OM 442.997						
OM 446.924						
OM 446.926						
OM 446.939						
3238 L 658.416, 658.468, 12763cc 3238 L 658.416, 658.468, 14618cc	07.87 - 09.96	OM 402.972		4300.90.01	430 10	- Engine code: OM402LA,423,442LA
	07.87 - 09.96	OM 402.985		4304.20.00	MFZ430	
		OM 402.986		4346.30.00	430WGTZ	
		OM 446.924		8905.40.00	KZIZ - 5	
		OM 446.925		4300.90.07	430 10	- Equipment Var: SA033617-01
		OM 446.927		4307.20.00	MFZ430	- Engine code: OM402LA,423,442LA
				4346.30.00	430WGTZ	
				8905.40.00	KZIZ - 5	
				4000.90.03	400 10	- Engine code: OM442LA
			4010.10.00	MFZ2/400X	- Equipment Var: SA/W25801/03	
		4021.30.00	400GVZ	- Vehicles with double disc clutch		
		8928.40.00	KZIZ - 5			
				3891.30.00	380 10	- Engine code: OM402LA,442LA
				380GS	- For PTO	
					- Loose clutch disc	
				9302.40.00	KZI-6	- Engine code: OM402LA,442LA
				3854.30.00	380 10	- Engine code: OM402LA,442LA
					380GVZ	















































3244

3244 625.130, 625.132, 625.131 3244 658.029, 658.043, 625.130-132	01.94 - 09.96	OM 440.970		4300.90.01	430 10	
		OM 440.980		4304.20.00	MFZ430	
		OM 446.939		4346.30.00	430WGTZ	
				8905.40.00	KZIZ - 5	
				4300.90.07	430 10	- Equipment Var: SA033617-01
				4307.20.00	MFZ430	
				4346.30.00	430WGTZ	
				8905.40.00	KZIZ - 5	

Vehicle list

					
---	---	---	--	---	---

MERCEDES-BENZ

3244					
3244 L 658.471	07.87 - 09.96	OM 440.970 OM 446.922	 4300.90.01	430 10	- Engine code: OM402LA,423,442LA MFZ430 430WGTZ KZIZ - 5
			 4304.20.00		
			 4346.30.00		
			 8905.40.00		
			 4300.90.07	430 10	
 4307.20.00	MFZ430				
			 4346.30.00	430WGTZ	
			 8905.40.00	KZIZ - 5	
			 3891.30.00	380 10	- Engine code: OM402LA,442LA - For PTO - Loose clutch disc
				380GS	
			 9302.40.00		- Engine code: OM402LA,442LA - For PTO
				KZI-6	
			 3854.30.00	380 10	- Engine code: OM402LA,442LA
				380GVZ	
3248					
3248, 24t 3248, 32t	07.87 - 09.96	OM 442.984	 4000.90.03	400 10	- To chassis no.: K011863 MFZ2/400X 400GVZ KZIZ - 5
	07.87 - 09.96	OM 442.985 OM 442.989 OM 442.992	 4010.10.00		
			 4021.30.00		
			 8928.40.00		
			 4300.90.07	430 10	- From chassis no.: K011864
			 4307.20.00	MFZ430	
			 4346.30.00	430WGTZ	
			 8905.40.00	KZIZ - 5	
3250					
3250			 4300.90.01	430 10	- Engine code: OM402LA,423,442LA MFZ430 430WGTZ KZIZ - 5
			 4304.20.00		
			 4346.30.00		
			 8905.40.00		
			 4300.90.07	430 10	- Equipment Var: SA033617-01
			 4307.20.00	MFZ430	
			 4346.30.00	430WGTZ	
			 8905.40.00	KZIZ - 5	
3250 L	07.87 - 09.96	OM 440.971 OM 440.973 OM 440.975 OM 442.997	 4000.90.03	400 10	- To chassis no.: K011863 MFZ2/400X 400GVZ KZIZ - 5
			 4010.10.00		
			 4021.30.00		
			 8928.40.00		
			 4300.90.07	430 10	- From chassis no.: K011864
			 4307.20.00	MFZ430	
			 4346.30.00	430WGTZ	
			 8905.40.00	KZIZ - 5	
3253					
3253, 3253 L	01.96 - 09.96	OM 446.920 OM 446.933 OM 446.945	 4300.90.01	430 10	- Engine code: OM402LA,423,442LA MFZ430 430WGTZ KZIZ - 5
			 4304.20.00		
			 4346.30.00		
			 8905.40.00		
			 4300.90.07	430 10	- Equipment Var: SA033617-01
			 4307.20.00	MFZ430	
			 4346.30.00	430WGTZ	
			 8905.40.00	KZIZ - 5	
			 4000.90.03	400 10	- Vehicles with double disc clutch - Special design
			 4010.10.00	MFZ2/400X	
			 4021.30.00	400GVZ	
			 8928.40.00	KZIZ - 5	



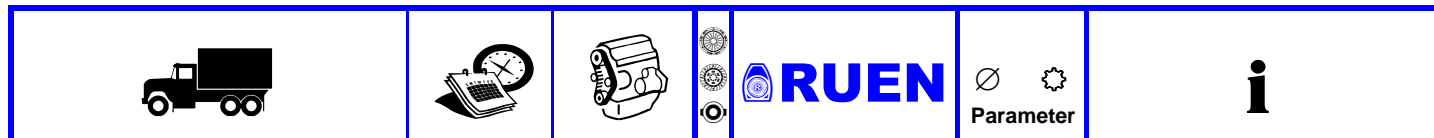



Vehicle list



MERCEDES-BENZ











3255						
3255	07.87 - 09.96	OM 446.920	4000.90.03 4010.10.00 4021.30.00 8928.40.00	400 10 MFZ2/400X 400GVZ KZIZ - 5	- To chassis no.: K011863	
			4300.90.07 4307.20.00 4346.30.00 8905.40.00	430 10 MFZ430 430WGTZ KZIZ - 5	- From chassis no.: K011864	
3328						
3328	02.80 - 03.91	OM 422.905 OM 422.911 OM 422.913	4200.90.16 4235.20.00 4257.30.00 8500.40.00	420 10 GF420KR 420GSZ KZI - 4,5		
			4225.20.00	420 GF420KR		
3328 B, 33t 3328 B, 26t 3328 K	07.82 - 07.87	OM 422.905	4200.90.16 4235.20.00 4257.30.00 8500.40.00	420 10 GF420KR 420GSZ KZI - 4,5		
	02.80 - 03.91	OM 422.907				
	07.82 - 07.87	OM 422.911				
		OM 422.913				
		OM 422.914		4225.20.00	420 GF420KR	
		OM 422.916		3882.10.00	380 GF2/380	- This part number includes one clutch disc
		OM 422.919		3855.30.00	380 10 380GS	- Loose clutch disc
				8520.40.00	KZI - 4,5	
			3882.20.00	380 GF2/380	- Contained in xxxx.10.00	
			3882.50.00	380 GF2/380	- Contained in xxxx.10.00	
			3883.30.00	380 10 380GSZ	- Contained in xxxx.10.00	
3332						
3332			4200.90.16 4235.20.00 4257.30.00 8500.40.00	420 10 GF420KR 420GSZ KZI - 4,5		
			4225.20.00	420 GF420KR		
3333						
3333 3333, Platform/Chassis 3333 K, Dump Truck 3333 B, Concrete Mixer	12.82 - 11.91	OM 422.954	4244.20.00	420 GFX420KR		
	12.82 - 11.91		4260.30.00	420 10 420GSZ		
	12.82 - 11.91		8513.40.00	KZI - 4,5		
			3857.10.00	380 GF2/380	- This part number includes one clutch disc	
			3892.30.00	380 10 380GSZ	- Loose clutch disc - Contained in xxxx.10.00	
			8520.40.00	KZI - 4,5		
			3857.20.00	380 G380KR	- Contained in xxxx.10.00	
			3857.50.00	380 GF2/380	- Contained in xxxx.10.00	

Vehicle list













					
---	---	---	--	---	---

MERCEDES-BENZ





3335

3335 3335 A	04.86 - 03.99 04.86 - 03.91	OM 442.950 OM 442.952 OM 442.962	 3882.10.00	380 GF2/380	- This part number includes one clutch disc
			 3855.30.00	380 10 380GS	- Loose clutch disc
			 8520.40.00	KZI - 4,5	
			 3882.20.00	380 GF2/380	- Contained in xxxx.10.00
			 3882.50.00	380 GF2/380	- Contained in xxxx.10.00
			 3883.30.00	380 10 380GSZ	- Contained in xxxx.10.00
3335			 4200.90.16	420 10	
			 4235.20.00	GF420KR	
			 4257.30.00	420GSZ	
			 8500.40.00	KZI - 4,5	
			 4225.20.00	420 GF420KR	

3336

3336			 4200.90.16	420 10	
			 4235.20.00	GF420KR	
3336 3336 A, 261kW 3336 A, 260kW 3336 AK 3336 K 3336 S 3336 B	12.82 - 11.91 11.81 - 03.91 11.81 - 03.91 09.86 - 11.91 12.82 - 11.91 12.82 - 11.91 12.82 - 11.91	OM 423.905 OM 423.907 OM 442.950 OM 442.952	 4257.30.00	420GSZ	
			 8500.40.00	KZI - 4,5	
			 4225.20.00	420 GF420KR	
			 4244.20.00	420 GFX420KR	
			 4260.30.00	420 10 420GSZ	
			 8513.40.00	KZI - 4,5	
			 3857.10.00	380 GF2/380	- This part number includes one clutch disc
			 3892.30.00	380 10 380GSZ	- Loose clutch disc - Contained in xxxx.10.00
 8520.40.00	KZI - 4,5				
 3857.20.00	380 G380KR	- Contained in xxxx.10.00			
 3857.50.00	380 GF2/380	- Contained in xxxx.10.00			

3338

3338	01.81 - 12.86	OM 442.950	 3857.10.00	380 GF2/380	- This part number includes one clutch disc
			 3892.30.00	380 10 380GSZ	- Loose clutch disc - Contained in xxxx.10.00
			 8520.40.00	KZI - 4,5	
			 3857.20.00	380 G380KR	- Contained in xxxx.10.00
			 3857.50.00	380 GF2/380	- Contained in xxxx.10.00

Vehicle list



MERCEDES-BENZ

3344

3344 ,S			3893.10.00	380 GF2/380	- This part number includes one clutch disc
			38125.30.00	380 10 380GS	- Loose clutch disc
			8520.40.00	KZI - 4,5	
			3882.20.00	380 GF2/380	- Contained in xxxx.10.00
			3882.50.00	380 GF2/380	- Contained in xxxx.10.00
			3892.30.00	380 10 380GSZ	- Contained in xxxx.10.00

3528

3528 3528 B 3528 K, 8X6/4 3528 K, 8x4	07.82 - 07.87 07.87 - 09.89 07.87 - 09.89 07.82 - 07.87	OM 422.905 OM 422.919	4200.90.16	420 10	
			4235.20.00	GF420KR	
			4257.30.00	420GSZ	
			8500.40.00	KZI - 4,5	
			4225.20.00	420 GF420KR	
			3882.10.00	380 GF2/380	- This part number includes one clutch disc
			3855.30.00	380 10 380GS	- Loose clutch disc
			8520.40.00	KZI - 4,5	
			3882.20.00	380 GF2/380	- Contained in xxxx.10.00
3882.50.00	380 GF2/380	- Contained in xxxx.10.00			
3883.30.00	380 10 380GSZ	- Contained in xxxx.10.00			

3529

3529	07.88 - 08.94	OM 442.906 OM 442.907 OM 442.925	4300.90.30	430 10	
			4305.20.00	MFZ430	
			4304.30.00	430WGTZ	
			8917.40.00	KZIZ - 5	

3534

3534 K	10.93 - 09.96	OM 441.988 OM 445.922	4300.90.01	430 10	
			4304.20.00	MFZ430	
			4346.30.00	430WGTZ	
			8905.40.00	KZIZ - 5	

3535 07.87 - 09.96

3535	07.88 - 08.94	OM 442.942 OM 442.944 OM 442.959 OM 442.964 OM 442.966	4300.90.01	430 10	- Special design
			4304.20.00	MFZ430	
			4346.30.00	430WGTZ	
			8905.40.00	KZIZ - 5	
			4300.90.30	430 10	
			4305.20.00	MFZ430	
			4304.30.00	430WGTZ	
			8917.40.00	KZIZ - 5	

Vehicle list



MERCEDES-BENZ

3535 07.87 - 09.96

3535 AK, 260kW	09.87 - 02.90	OM 442.950 OM 442.952	4200.90.16	420 10	
			4235.20.00	GF420KR	
			4257.30.00	420GSZ	
			8500.40.00	KZI - 4,5	
			4225.20.00	420	
				GF420KR	
			3882.10.00	380	- This part number includes one clutch disc
				GF2/380	
3535 AK, 266kW 3535 B, 269kW 3535 B, 362kW 3535 K, 269kW 3535 K, 362kW 3535 S	02.90 - 08.94 10.88 - 08.94 10.88 - 08.94 10.88 - 08.94 10.88 - 08.94 07.88 - 08.94	OM 440.940 OM 442.944 OM 442.945 OM 442.946 OM 442.957 OM 442.959 OM 442.964 OM 442.989	4300.90.01	430 10	
			4304.20.00	MFZ430	
			4346.30.00	430WGTZ	
			8905.40.00	KZIZ - 5	
			4000.90.03	400 10	- Vehicles with double disc clutch
				MFZ2/400X	
			4010.10.00	400GVZ	
			4021.30.00	KZIZ - 5	
3535 AK, 280kW 3535 K, 280kW	03.91 - 08.94 03.91 - 08.94	OM 402.982 OM 402.983	4300.90.01	430 10	
			4304.20.00	MFZ430	
			4346.30.00	430WGTZ	
			8905.40.00	KZIZ - 5	
			4000.90.03	400 10	- Vehicles with double disc clutch
				MFZ2/400X	
			4010.10.00	400GVZ	
			4021.30.00	KZIZ - 5	
3535 K, 260kW, 8x4/4	09.87 - 01.89	OM 442.950 OM 442.959	4300.90.01	430 10	
			4304.20.00	MFZ430	
			4346.30.00	430WGTZ	
			8905.40.00	KZIZ - 5	
			3882.10.00	380	- This part number includes one clutch disc
				GF2/380	
			3855.30.00	380 10	- Loose clutch disc
				380GS	
3535 K, 260kW, 6x4 3535 L,K	07.87 - 09.96	OM 442.942 OM 442.966	4300.90.30	430 10	
			4305.20.00	MFZ430	
			4304.30.00	430WGTZ	
			8917.40.00	KZIZ - 5	
			4300.90.01	430 10	- Special design
				MFZ430	
			4304.20.00	430WGTZ	
			8905.40.00	KZIZ - 5	

Vehicle list



MERCEDES-BENZ

3536

3536 K 3536 S	12.82 - 11.91	OM 423.907	4244.20.00	420 GFX420KR	
			4260.30.00	420 10 420GSZ	
			8513.40.00	KZI - 4.5	
			3857.10.00	380 GF2/380	- This part number includes one clutch disc - Special design
			3892.30.00	380 10 380GSZ	- Loose clutch disc - Contained in xxxx.10.00 - Special design
			8520.40.00	KZI - 4,5	- Special design
			3857.20.00	380 G380KR	- Contained in xxxx.10.00 - Special design
			3857.50.00	380 GF2/380	- Contained in xxxx.10.00 - Special design

3538 03.91 - 09.96

3538, 12763cc 3538, 14618cc 3538 AK, 280kW, 12763cc 3538 AK, 280kW, 14618cc 3538 AK, 320kW 3538 AK, 370kW 3538 K, 362kW 3538 K, 280kW, 12763cc 3538 K, 280kW, 14618cc 3538 K, 320kW	03.91 - 09.96 03.91 - 09.96 03.91 - 09.96 01.94 - 09.96 03.91 - 09.96 03.91 - 09.96 03.91 - 09.96 03.91 - 09.96 03.91 - 09.96 01.94 - 09.96 03.91 - 09.96 01.94 - 09.96 03.91 - 09.96	OM 402.973 OM 402.978 OM 402.982 OM 402.983 OM 402.987 OM 440.970 OM 440.975 OM 440.979 OM 440.982 OM 440.983 OM 440.984 OM 440.985 OM 440.987 OM 442.989 OM 442.997 OM 446.926 OM 446.930 OM 446.931 OM 446.939 OM 446.940	4300.90.01	430 10 MFZ430	
			4304.20.00	430WGTZ	
			4346.30.00	430WGTZ	
			8905.40.00	KZIZ - 5	
			4300.90.07	430 10 MFZ430	- Equipment Var: SA33613 - Equipment Var: SA33617
			4307.20.00	430WGTZ	
			4346.30.00	430WGTZ	
			8905.40.00	KZIZ - 5	
			4000.90.03	400 10 MFZ2/400X	- Equipment Var: SA32903-01/12 - Equipment Var: SA32903-05 - Vehicles with double disc clutch
			4010.10.00	400GVZ	
			4021.30.00	400GVZ	
			8928.40.00	KZIZ - 5	

3538			4300.90.30	430 10 MFZ430	
			4305.20.00	430WGTZ	
			4304.30.00	430WGTZ	
			8917.40.00	KZIZ - 5	
			4300.90.01	430 10 MFZ430	- Special design
			4304.20.00	430WGTZ	
			4346.30.00	430WGTZ	
			8905.40.00	KZIZ - 5	
			4000.90.03	400 10 MFZ2/400X	

3538 AK			4300.90.01	430 10 MFZ430	
			4304.20.00	430WGTZ	
			4346.30.00	430WGTZ	
			8905.40.00	KZIZ - 5	
			4000.90.03	400 10 MFZ2/400X	- Vehicles with double disc clutch
			4010.10.00	400GVZ	



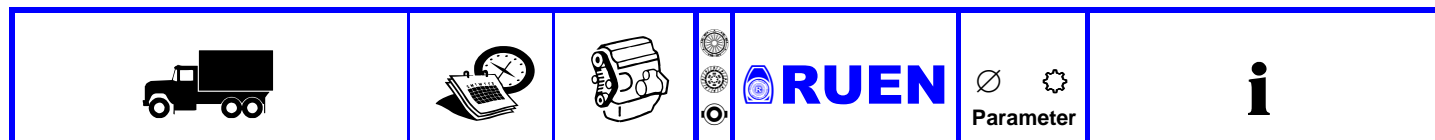



Vehicle list



















































MERCEDES-BENZ

3544		03.91 - 09.96			
3544 648.073, 6x2	08.73 - 09.96	OM 442.951 OM 442.953 OM 442.980	3893.10.00	380 GF2/380	- This part number includes one clutch disc
			38125.30.00	380 10 380GS	- Loose clutch disc
			8520.40.00	KZI - 4,5	
			3882.20.00	380 GF2/380	- Contained in xxxx.10.00
			3882.50.00	380 GF2/380	- Contained in xxxx.10.00
			3892.30.00	380 10 380GSZ	- Contained in xxxx.10.00
3544 659.093, 659.191, 6x4	01.92 - 09.96	OM 440.970 OM 440.978 OM 446.922	4000.90.03	400 10 MFZ2/400X 400GVZ KZIZ - 5	- To chassis no.: K011863
			4300.90.07	430 10 MFZ430 430WGTZ KZIZ - 5	- From chassis no.: K011864
			4307.20.00		
			4346.30.00		
			8905.40.00		
			4300.90.01	430 10 MFZ430 430WGTZ KZIZ - 5	
3544 AK 625.269 3544 K 625.136 3544 ,K,AK 625.136, 625.259, 625.137, 625.258, 625.269	03.91 - 09.96 03.91 - 09.96 03.91 - 09.96	OM 440.970 OM 440.980 OM 440.985	4300.90.01	430 10 MFZ430 430WGTZ KZIZ - 5	
			4304.20.00		
			4346.30.00		
			8905.40.00		
			4300.90.07	430 10 MFZ430 430WGTZ KZIZ - 5	- Equipment Var: SA033617-01 - Engine code: OM402LA,442LA
			4307.20.00		
3544 S 649.196	08.73 - 09.96	OM 442.951 OM 442.980	3891.30.00	380 10 380GS	- Engine code: OM442LA - Loose clutch disc
			9302.40.00	KZI-6	- Engine code: OM442LA
			3854.30.00	380 10 380GVZ	- Engine code: OM442LA
			3893.10.00	380 GF2/380	- Engine code: OM442LA
			8520.40.00	KZI - 4,5	- Engine code: OM442LA
			3882.20.00	380 GF2/380	- Engine code: OM442LA
3548	05.92 - 09.96	OM 440.975 OM 442.993	3889.30.00	380 10 380GSZ	- Engine code: OM442LA
			4300.90.01	430 10 MFZ430 430WGTZ KZIZ - 5	
			4304.20.00		
			4346.30.00		
			8905.40.00		
			4300.90.30	430 10 MFZ430 430WGTZ KZIZ - 5	
3548			4300.90.01	430 10 MFZ430 430WGTZ KZIZ - 5	- Special design
			4304.20.00		
			4346.30.00		
			8905.40.00		







Vehicle list

					
---	---	---	--	---	---

MERCEDES-BENZ









3548		05.92 - 09.96				
3548 S				4000.90.03	400 10	- To chassis no.: K011863
				 4010.10.00  4021.30.00  8928.40.00	MFZ2/400X 400GVZ KZIZ - 5	
				4300.90.07	430 10	- From chassis no.: K011864
				 4307.20.00  4346.30.00  8905.40.00	MFZ430 430WGTZ KZIZ - 5	
3550		03.91 - 09.96				
3550	01.88 -			4300.90.30	430 10	
				 4305.20.00  4304.30.00  8917.40.00	MFZ430 430WGTZ KZIZ - 5	
3550, 370kW	05.92 - 09.96	OM 440.975 OM 440.976 OM 442.993 OM 442.997		4300.90.01	430 10	
				 4304.20.00  4346.30.00  8905.40.00	MFZ430 430WGTZ KZIZ - 5	
					4000.90.03	400 10
				 4010.10.00  4021.30.00  8928.40.00	MFZ2/400X 400GVZ KZIZ - 5	
				4300.90.07	430 10	- From chassis no.: K011864
				 4307.20.00  4346.30.00  8905.40.00	MFZ430 430WGTZ KZIZ - 5	
3550 ,K,S 3550 K	03.91 - 09.96	OM 440.975 OM 440.982 OM 442.997		4300.90.01	430 10	
				 4304.20.00  4346.30.00  8905.40.00	MFZ430 430WGTZ KZIZ - 5	
				4300.90.07	430 10	- Equipment Var: SA033617-01
				 4307.20.00  4346.30.00  8905.40.00	MFZ430 430WGTZ KZIZ - 5	
3550 S	05.92 - 09.96	OM 440.975 OM 442.993 OM 442.997		4000.90.03	400 10	- To chassis no.: K011863
				 4010.10.00  4021.30.00  8928.40.00	MFZ2/400X 400GVZ KZIZ - 5	
				4300.90.07	430 10	- From chassis no.: K011864
				 4307.20.00  4346.30.00  8905.40.00	MFZ430 430WGTZ KZIZ - 5	
3550 S, 3553 S	05.92 - 09.96	OM 440.975 OM 442.993 OM 442.997		4300.90.01	430 10	
				 4304.20.00  4346.30.00  8905.40.00	MFZ430 430WGTZ KZIZ - 5	
3553		04.94 -				
3553 S	04.92 -	OM 446.933		4300.90.01	430 10	
				 4304.20.00  4346.30.00  8905.40.00	MFZ430 430WGTZ KZIZ - 5	

Vehicle list

					
---	---	---	--	---	---

MERCEDES-BENZ







3636

3636			 3857.10.00	380 GF2/380	- This part number includes one clutch disc
			 3892.30.00	380 10 380GSZ	- Loose clutch disc - Contained in xxxx.10.00 - Special design
			 8520.40.00	KZI - 4,5	- Special design
			 3857.20.00	380 G380KR	- Contained in xxxx.10.00 - Special design
			 3857.50.00	380 GF2/380	- Contained in xxxx.10.00 - Special design
3636 AK			 4244.20.00	420 GFX420KR	
			 4260.30.00	420 10 420GSZ	
			 8513.40.00	KZI - 4.5	







3836

3836 AK 624.339	11.81 - 03.91	OM 423.907	 4258.30.00	420 10 420GSZ	- For PTO
-----------------	---------------	------------	---	-------------------------	-----------





3844

3844 ,S			 3893.10.00	380 GF2/380	- This part number includes one clutch disc
			 38125.30.00	380 10 380GS	- Loose clutch disc
			 8520.40.00	KZI - 4,5	
			 3882.20.00	380 GF2/380	- Contained in xxxx.10.00
			 3882.50.00	380 GF2/380	- Contained in xxxx.10.00
			 3892.30.00	380 10 380GSZ	- Contained in xxxx.10.00







4044

4044 S			 3893.10.00	380 GF2/380	- This part number includes one clutch disc
			 38125.30.00	380 10 380GS	- Loose clutch disc
			 8520.40.00	KZI - 4,5	
			 3882.20.00	380 GF2/380	- Contained in xxxx.10.00
			 3882.50.00	380 GF2/380	- Contained in xxxx.10.00
			 3892.30.00	380 10 380GSZ	- Contained in xxxx.10.00









































4435

4435 ,K			 4300.90.01	430 10	
			 4304.20.00	MFZ430	
			 4346.30.00	430WGTZ	
			 8905.40.00	KZIZ - 5	







Vehicle list

					
---	---	---	--	---	---

MERCEDES-BENZ









4436					
4436 AK		4244.20.00	420 GFX420KR		
		4260.30.00	420 10 420GSZ		
		8513.40.00	KZI - 4,5		
		3857.10.00	380 GF2/380		- This part number includes one clutch disc
		3892.30.00	380 10 380GSZ		- Loose clutch disc - Contained in xxxx.10.00 - Special design
		8520.40.00	KZI - 4,5		
		3857.20.00	380 G380KR		- Contained in xxxx.10.00 - Special design
		3857.50.00	380 GF2/380		- Contained in xxxx.10.00 - Special design
4445					
4445		4200.90.17	420 10 GF420KR		
		4235.20.00	GF420KR		
		4258.30.00	420GSZ		
		8500.40.00	KZI - 4,5		
		4225.20.00	420 GF420KR		
4635					
4635		4300.90.01	430 10		- Special design
		4304.20.00	MFZ430		
		4346.30.00	430WGTZ		
		8905.40.00	KZIZ - 5		
		4300.90.30	430 10		
		4305.20.00	MFZ430		
	4304.30.00	430WGTZ			
	8917.40.00	KZIZ - 5			
4644					
4644		4300.90.30	430 10		
		4305.20.00	MFZ430		
		4304.30.00	430WGTZ		
		8917.40.00	KZIZ - 5		
		4300.90.01	430 10		- Special design
		4304.20.00	MFZ430		
		4346.30.00	430WGTZ		
	8905.40.00	KZIZ - 5			
4645					
4645		4200.90.17	420 10 GF420KR		
		4235.20.00	GF420KR		
		4258.30.00	420GSZ		
		8500.40.00	KZI - 4,5		
		4225.20.00	420 GF420KR		
		4300.90.30	430 10		
		4305.20.00	MFZ430		
		4304.30.00	430WGTZ		
		8917.40.00	KZIZ - 5		
		4300.90.01	430 10		- Special design
		4304.20.00	MFZ430		
		4346.30.00	430WGTZ		
	8905.40.00	KZIZ - 5			

Vehicle list









					
---	---	---	--	---	---







MERCEDES-BENZ

4648















4648			 4300.90.30  4305.20.00  4304.30.00  8917.40.00	430 10 MFZ430 430WGTZ KZIZ - 5	
			 4300.90.01  4304.20.00  4346.30.00  8905.40.00	430 10 MFZ430 430WGTZ KZIZ - 5	- Special design

4844 03.91 - 09.96







4844 4844 ,K 4844 K	12.91 - 08.94 03.91 - 09.96	OM 440.970 OM 440.979 OM 440.984 OM 446.940	 4300.90.01  4304.20.00  4346.30.00  8905.40.00	430 10 MFZ430 430WGTZ KZIZ - 5	
			 4300.90.07  4307.20.00  4346.30.00  8905.40.00	430 10 MFZ430 430WGTZ KZIZ - 5	- Equipment Var: SA033617-01

4844 S			 3893.10.00	380 GF2/380	- This part number includes one clutch disc
			 38125.30.00	380 10 380GS	- Loose clutch disc
			 8520.40.00	KZI - 4,5	
			 3882.20.00	380 GF2/380	- Contained in xxxx.10.00
			 3882.50.00	380 GF2/380	- Contained in xxxx.10.00
			 3892.30.00	380 10 380GSZ	- Contained in xxxx.10.00















































4850

4850			 4300.90.01  4304.20.00  4346.30.00  8905.40.00	430 10 MFZ430 430WGTZ KZIZ - 5	- Special design
			 4300.90.07  4307.20.00  4346.30.00  8905.40.00	430 10 MFZ430 430WGTZ KZIZ - 5	- Equipment Var: SA033617-01
			 4300.90.30  4305.20.00  4304.30.00  8917.40.00	430 10 MFZ430 430WGTZ KZIZ - 5	
			 3891.30.00	380 10 380GS	- Engine code: OM442LA
			 9302.40.00	KZI-6	- Engine code: OM442LA
			 3854.30.00	380 10 380GVZ	- Engine code: OM442LA

Vehicle list

					
---	---	---	--	---	---

MERCEDES-BENZ

4850						
4850 A 625.057	07.87 -	OM 423.950	 4300.90.01	430 10	- Engine code: OM442LA	
			 4304.20.00	MFZ430	- Engine code: OM443A	
			 4346.30.00	430WGTZ	- Special design	
			 8905.40.00	KZIZ - 5		
			 4300.90.07	430 10	- Equipment Var: SA033617-01	
			 4307.20.00	MFZ430	- Engine code: OM442LA	
			 4346.30.00	430WGTZ		
 8905.40.00	KZIZ - 5					
 4300.90.30	430 10	- Engine code: OM443A				
 4305.20.00	MFZ430					
 4304.30.00	430WGTZ					
 8917.40.00	KZIZ - 5					
 3891.30.00	380 10	- Engine code: OM442LA				
	380GS					
 9302.40.00	380 10	- Engine code: OM442LA				
	KZI-6					
 3854.30.00	380 10	- Engine code: OM442LA				
	380GVZ					
4853						
4853			 4300.90.01	430 10		
			 4304.20.00	MFZ430		
			 4346.30.00	430WGTZ		
			 8905.40.00	KZIZ - 5		
			 4300.90.07	430 10	- Equipment Var: SA033617-01	
			 4307.20.00	MFZ430		
			 4346.30.00	430WGTZ		
			 8905.40.00	KZIZ - 5		
5035						
5035			 4300.90.30	430 10		
			 4305.20.00	MFZ430		
			 4304.30.00	430WGTZ		
			 8917.40.00	KZIZ - 5		
			 4300.90.01	430 10	- Special design	
			 4304.20.00	MFZ430		
			 4346.30.00	430WGTZ		
			 8905.40.00	KZIZ - 5		
5038						
5038 ,AK			 4300.90.01	430 10		
			 4304.20.00	MFZ430		
			 4346.30.00	430WGTZ		
			 8905.40.00	KZIZ - 5		
			 4300.90.07	430 10	- Equipment Var: SA033617-01	
			 4307.20.00	MFZ430		
			 4346.30.00	430WGTZ		
			 8905.40.00	KZIZ - 5		
5248						
5248 K			 4000.90.03	400 10	- To chassis no.: K011863	
			 4010.10.00	MFZ2/400X		
			 4021.30.00	400GVZ		
			 8928.40.00	KZIZ - 5		
			 4300.90.07	430 10	- From chassis no.: K011864	
			 4307.20.00	MFZ430		
			 4346.30.00	430WGTZ		
			 8905.40.00	KZIZ - 5		

Vehicle list

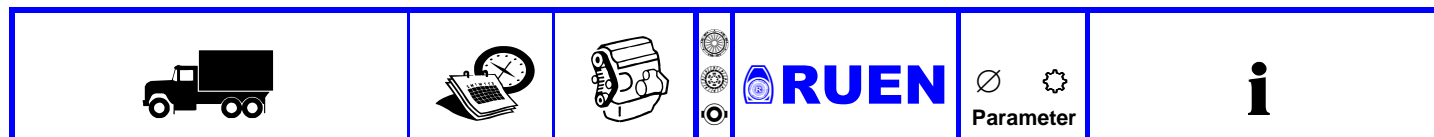

MERCEDES-BENZ

SPRINTER 3-t Box (903) 02.95 - 05.06

314	02.95 - 05.06	M 111.979 M 111.984		2400.90.05		
-----	---------------	------------------------	--	-------------------	--	--

SPRINTER 3-t Platform (903) 02.95 - 05.06

314	02.95 - 05.06	M 111.984		2400.90.05		
-----	---------------	-----------	--	-------------------	--	--

SPRINTER 3-t Box (906) 06.06 -

218 CDI (906.611, 906.613)	06.06 - 12.09	OM 642.896		2665.30.00	260 26 260 CTD	
219 CDI / BlueTEC (906.611, 906.613)	03.09 -	OM 642.992				

216 (906.613)	09.08 -	M		2418.30.00	240 26 240CTB	
209 CDI (906.611, 906.613)	06.06 - 12.09	271.951				
211 CDI (906.611, 906.613)	06.06 - 12.09	OM 646.984				
213 CDI (906.611, 906.613)	06.06 - 12.09	OM 646.985				
215 CDI (906.611, 906.613)	06.06 - 12.09	OM 646.986 OM 646.989 OM 646.990				

SPRINTER 3-t Platform (906) 06.06 -

218 CDI (906.111, 906.113, 906.211, 906.213)	06.06 - 12.09	OM 642.896		2665.30.00	260 26 260 CTD	
219 CDI / BlueTEC (906.111, 906.113, 906.211, 906.213)	03.09 - 05.16	OM 642.992 OM 642.993				

SPRINTER 3,5-t Box (906) 06.06 -

318 CDI (906.631, 906.633, 906.635, 906.637)	06.06 - 12.09	OM 642.896		2665.30.00	260 26 260 CTD	
318 CDI 4x4 (906.631, 906.633, 906.635, 906.637)	02.08 - 12.09	OM 642.898				
319 CDI / BlueTEC (906.631, 906.633, 906.635, 906.637)	03.09 -	OM 642.992				
319 CDI / BlueTEC 4x4 (906.631, 906.633, 906.635, 906.637)	03.09 -	OM 642.993				

316 (906.635, 906.633)	09.08 -	M		2418.30.00	240 26 240CTB	
316 NGT (906.633, 906.635)	09.08 -	271.951				
316 LGT (906.633, 906.635)	09.08 -	OM 651.955				
309 CDI (906.631, 906.633, 906.635, 906.637)	06.06 - 12.09	OM 646.984				
310 CDI (906.631, 906.633, 906.635, 906.637)	03.09 -	OM 646.985 OM 646.986				
311 CDI (906.631, 906.633, 906.635, 906.637)	06.06 - 12.09	OM 646.989 OM 646.990				
311 CDI 4x4 (906.631, 906.633, 906.635, 906.637)	02.08 - 12.09	OM 651.957				
313 CDI (906.631, 906.633, 906.635, 906.637)	06.06 -					
315 CDI (906.631, 906.633, 906.635, 906.637)	06.06 - 12.09					
315 CDI 4x4 (906.631, 906.633, 906.635, 906.637)	02.08 - 12.09					
316 CDI (906.631, 906.633, 906.635, 906.637)	03.09 -					
316 CDI 4x4 (906.631, 906.633, 906.635, 906.637)	03.09 -					

SPRINTER 3,5-t Platform (906) 06.06 -

318 CDI (906.131, 906.133, 906.135, 906.231, 906.233...)	06.06 - 12.09	OM 642.896		2665.30.00	260 26 260 CTD	
318 CDI 4x4 (906.131, 906.133, 906.135, 906.231...)	02.08 - 12.09	OM 642.898				
319 CDI / BlueTEC (906.131, 906.133, 906.135, 906.231...)	03.09 -	OM 642.992				
319 CDI / BlueTEC 4x4 (906.131, 906.133, 906.135...)	05.11 -	OM 642.993				

Vehicle list



MERCEDES-BENZ

SPRINTER 3,5-t Platform (906)		06.06 -							
316 (906.133, 906.135, 906.233, 906.235)	09.08 -	M 271.951		2418.30.00	240 26 240CTB				
316 NGT (906.133, 906.135, 906.233, 906.235)	09.08 -	OM 651.955							
	09.08 -	OM 651.956							
316 LGT (906.133, 906.135, 906.233, 906.235)	09.08 -	OM 646.984							
		OM 646.985							
309 CDI (906.131, 906.133, 906.135, 906.231, 906.233...)	06.06 - 12.09	OM 646.986							
310 CDI (906.131, 906.133, 906.135, 906.231, 906.233...)	03.09 - 05.16	OM 646.989							
311 CDI (906.131, 906.133, 906.135, 906.231, 906.233...)	06.06 - 12.09	OM 651.957							
311 CDI 4x4 (906.131, 906.133, 906.135, 906.231...)	02.08 - 12.09								
313 CDI 4x4 (906.131, 906.133, 906.135, 906.231...)	06.06 - 05.16								
313 CDI (906.131, 906.133, 906.135, 906.231, 906.233...)	06.06 - 05.16								
315 CDI (906.131, 906.133, 906.135, 906.231, 906.233...)	06.06 - 12.09								
315 CDI 4x4 (906.131, 906.133, 906.135, 906.231...)	02.08 - 12.09								
316 CDI (906.131, 906.133, 906.135, 906.231, 906.233...)	03.09 -								
316 CDI 4x4 (906.131, 906.133, 906.135, 906.231...)	03.09 -								
SPRINTER 4,6-t Box (906)		06.06 -							
419 CDI (906.653, 906.655, 906.657)	03.09 -	OM 642.992					2665.30.00	260 26 260 CTD	
411 CDI (906.653, 906.655, 906.657)	06.09 - 12.09	OM 646.985		2418.30.00	240 26 240CTB				
413 CDI (906.653, 906.655, 906.657)	06.06 - 05.16	OM 646.986							
415 CDI (906.653, 906.655, 906.657)	06.09 - 12.09	OM 646.989							
416 CDI (906.653, 906.655, 906.657)	03.09 -	OM 646.990 OM 651.957							
SPRINTER 4,6-t Platform (906)		06.06 -							
418 CDI (906.153, 906.155, 906.253, 906.255)	06.06 - 12.09	OM 642.896		2665.30.00	260 26 260 CTD				
419 CDI (906.153, 906.155, 906.253, 906.255)	03.09 -	OM 642.898 OM 642.992 OM 642.993							
411 CDI (906.153, 906.155, 906.253, 906.255)	06.09 - 12.09	OM 646.985		2418.30.00	240 26 240CTB				
413 CDI (906.153, 906.155, 906.253, 906.255)	06.06 - 05.16	OM 646.986 OM 646.989							
415 CDI (906.153, 906.155, 906.253, 906.255)	06.06 - 12.09	OM 646.990							
416 CDI (906.153, 906.155, 906.253, 906.255)	03.09 -	OM 651.957							
SPRINTER 5-t Box (906)		06.06 -							
518 CDI (906.653, 906.655, 906.657)	06.06 - 12.09	OM 642.896		2665.30.00	260 26 260 CTD				
519 CDI / BlueTEC (906.653, 906.655, 906.657)	03.09 -	OM 642.898 OM 642.992 OM 642.993							

Vehicle list

					
---	---	---	--	---	---

MERCEDES-BENZ



SPRINTER 5-t Box (906)

06.06 -

509 CDI (906.653, 906.655, 906.657)	06.06 - 12.09	OM		2418.30.00	240 26 240CTB	
510 CDI (906.653, 906.655, 906.657)	03.09 - 05.16	651.955 OM 646.984				
511 CDI (906.653, 906.655, 906.657)	06.06 - 12.09	OM 646.985				
511 CDI 4x4 (906.653, 906.655, 906.657)	06.06 - 12.09	OM 646.986 OM 646.989				
513 CDI (906.653, 906.655, 906.657)	06.06 -	OM 646.990				
515 CDI (906.653, 906.655, 906.657)	06.06 - 12.09	OM 651.957				
515 CDI 4x4 (906.653, 906.655, 906.657)	06.06 -					
516 CDI (906.653, 906.655, 906.657)	03.09 -					

SPRINTER 5-t Platform (906)

06.06 -

518 CDI (906.153, 906.155, 906.253, 906.255)	06.06 - 12.09	OM 642.896 OM 642.898		2665.30.00	260 26 260 CTD	
518 CDI 4x4 (906.153, 906.155, 906.253, 906.255)	06.06 - 12.09	OM 642.992 OM 642.993				
519 CDI / BlueTEC (906.153, 906.155, 906.253, 906.255)	03.09 -					
519 CDI / BlueTEC 4x4 (906.153, 906.155, 906.253, 906.255)	03.09 -					
516 (906.153, 906.155, 906.253, 906.255)	09.08 -	M 271.951		2418.30.00	240 26 240CTB	
516 NGT (906.153, 906.155, 906.253, 906.255)	09.08 -	OM 651.955				
509 CDI (906.153, 906.155, 906.253, 906.255)	06.06 - 12.09	OM 651.956 OM 646.984				
510 CDI (906.153, 906.155, 906.253, 906.255)	03.09 -	OM 646.985				
511 CDI (906.153, 906.155, 906.253, 906.255)	06.06 - 12.09	OM 646.986 OM 646.989				
511 CDI 4x4 (906.155, 906.253, 906.255)	06.06 - 12.09	OM 646.990 OM 651.957				
513 CDI (906.155, 906.253, 906.255)	06.06 - 05.16					
513 CDI 4x4 (906.155, 906.253, 906.255)	05.11 - 05.16					
513 CDI (906.155, 906.253, 906.255)	06.06 - 05.16					
515 CDI (906.153, 906.155, 906.253, 906.255)	06.06 - 12.09					
515 CDI 4x4 (906.153, 906.155, 906.253, 906.255)	06.06 - 12.09					
516 CDI (906.153, 906.155, 906.253, 906.255)	03.09 -					
516 CDI 4x4 (906.153, 906.155, 906.255)	05.11 -					



SPRINTER 3-t Platform/Chassis

06.06 -







216 (906.113, 906.213)	09.08 - 05.16	M		2418.30.00	240 26 240CTB	
209 CDI (906.111, 906.113, 906.211, 906.213)	06.06 - 12.09	271.951 OM				
211 CDI (906.111, 906.113, 906.211, 906.213)	06.06 - 12.09	651.956 OM 646.984				
213 CDI (906.111, 906.113, 906.211, 906.213)	06.06 - 12.09	OM 646.985 OM 646.989				
2015 CDI (906.111, 906.113, 906.211, 906.213)	06.06 - 12.09	OM 646.990				

ÖSTERREICHISCHE AUTOMOBILFABRIK (ÖAF)











































16...

16.192 H, HA, F				3521.20.00	350 GF350KR	
				3516.30.00	350 10 350WGSZ	
				8505.40.00	KZI - 4,5	







Vehicle list

					
---	---	---	--	---	---







































ÖSTERREICHISCHE AUTOMOBILFABRIK (ÖAF)

17...						
17.192 E49	01.88 -		 3879.20.00	380 GMF380		
			 3816.30.00	380 10 380GSZ		
			 8505.40.00	KZI - 4,5		
17.232 E49	01.89 -		 3879.20.00	380 GMF380		
			 3816.30.00	380 10 380GSZ		
			 8505.40.00	KZI - 4,5		
18...						
18.373 E61		D 2866 LF21	 4300.90.05	430 10 MFZ430		
			 4301.20.00	430WGTZ		
			 4346.30.00	KZIZ - 5		
			 8916.40.00			
18.403 E61		D 2866 LF20	 4300.90.05	430 10 MFZ430		
			 4301.20.00	430WGTZ		
			 4346.30.00	KZIZ - 5		
			 8916.40.00			
18.423 E61		D 2866 LF22	 4300.90.05	430 10 MFZ430		
			 4301.20.00	430WGTZ		
			 4346.30.00	KZIZ - 5		
			 8916.40.00			
18.463 E61		D 2876 LF 02	 4300.90.05	430 10 MFZ430		
			 4301.20.00	430WGTZ		
			 4346.30.00	KZIZ - 5		
			 8916.40.00			
19...						
19.192 H, HA			 3521.20.00	350 GF350KR		
			 3516.30.00	350 10 350WGSZ		
			 8505.40.00	KZI - 4,5		
19.230 H, HA, F			 3861.30.00	380 10 380W2GSZ		
			 8505.40.00	KZI - 4,5		
19.256 H, HA, F 19.304 F			 4234.20.00	420 GF420KR		
			 4222.20.00	420 GF420KR		
			 4283.30.00	420 10 420WGSZ		
			 8505.40.00	KZI - 4,5		
19.273 E52	01.94 -		 4300.90.49	430 10 MFZ430		
19.293 E52	01.94 -		 4301.20.00	430WGTZ		
19.323 E52	01.94 -		 4346.30.00	KZIZ - 5		
19.344 E52	01.94 -		 8916.40.00			
19.373 E61,62 19.404 E61,62 19.423 E61,62 19.464 E61,62		D 2866 LF20	 4300.90.05	430 10 MFZ430		
		D 2866 LF21	 4301.20.00	430WGTZ		
		D 2866 LF22	 4346.30.00	KZIZ - 5		
		D 2876 LF 02	 8916.40.00			
19.344 E52	01.94 -		 4300.90.49	430 10 MFZ430		- Engine code: D2865
			 4301.20.00	430WGTZ		
			 4346.30.00	KZIZ - 5		
			 8916.40.00			







Vehicle list

					
---	---	---	--	---	---











































ÖSTERREICHISCHE AUTOMOBILFABRIK (ÖAF)

19...					
19.463 E61,62	01.95 -		 43461.30.00	430 10 430WGTZ	- Engine code: D2866LF - For PTO
19.464 E61,62	01.95 -		 8950.40.00	KZIZ-6	- Engine code: D2866LF - For PTO
21...					
21.273 E52	01.94 -		 4300.90.49	430 10	
21.293 E52	01.94 -		 4301.20.00	MFZ430	
21.323 E52	01.94 -		 4346.30.00	430WGTZ	
21.343 E52	01.94 -		 8916.40.00	KZIZ - 5	
21.373 E62	01.94 -		 4300.90.49	430 10	
21.403 E62	01.94 -		 4301.20.00	MFZ430	
21.423 E62	01.94 -		 4346.30.00	430WGTZ	
21.463 E62	01.94 -		 8916.40.00	KZIZ - 5	
22...					
22.192 FN			 3521.20.00	350 GF350KR	
			 3516.30.00	350 10 350WGSZ	
			 8505.40.00	KZI - 4,5	
22.230 HN, HNA, FN			 3861.30.00	380 10 380W2GSZ	
			 8505.40.00	KZI - 4,5	
22.256 HN, HNA, FN 22.304 FN			 4234.20.00	420 GF420KR	
			 4222.20.00	420 GF420KR	
			 4283.30.00	420 10 420WGSZ	
			 8505.40.00	KZI - 4,5	
24...					
24.273 E53			 4300.90.49	430 10	
24.293 E53			 4301.20.00	MFZ430	
24.323 E53			 4346.30.00	430WGTZ	
24.343 E53			 8916.40.00	KZIZ - 5	
26...					
26.273 E53,69			 4300.90.49	430 10	
26.293 E53,69			 4301.20.00	MFZ430	
26.323 E53,69			 4346.30.00	430WGTZ	
26.343 E53,69			 8916.40.00	KZIZ - 5	
26.352 E76,78	01.94 -		 4300.90.05	430 10	
26.482 E76,78	01.94 -		 4301.20.00	MFZ430	
			 4346.30.00	430WGTZ	
			 8916.40.00	KZIZ - 5	
26.373 E72	01.94 -		 4300.90.49	430 10	
26.404 E69,72	01.94 -		 4301.20.00	MFZ430	
26.423 E69,72	01.94 -		 4346.30.00	430WGTZ	
26.464 E69,72	01.94 -		 8916.40.00	KZIZ - 5	
26.463 E69	01.94 -		 4300.90.49	430 10	
			 4301.20.00	MFZ430	
			 4346.30.00	430WGTZ	
			 8916.40.00	KZIZ - 5	







Vehicle list

					
---	---	---	--	---	---

















































ÖSTERREICHISCHE AUTOMOBILFABRIK (ÖAF)

27...					
27.273 E53,69				4300.90.49	430 10
27.293 E53,69				4301.20.00	MFZ430
27.323 E53,69				4346.30.00	430WGTZ
27.343 E53,69				8916.40.00	KZIZ - 5
27.403 E53,69,72					
27.423 E53,69,72					
27.463 E53,69,72					
27.373 E72				4300.90.49	430 10
27.403 E69,72				4301.20.00	MFZ430
27.423 E69,72				4346.30.00	430WGTZ
27.463 E69,72				8916.40.00	KZIZ - 5
28...					
28.273 E69				4300.90.49	430 10
28.403 E69				4301.20.00	MFZ430
28.423 E69				4346.30.00	430WGTZ
28.463 E69				8916.40.00	KZIZ - 5
30...					
30.230 HD, HDA				3861.30.00	380 10
				8505.40.00	380W2GSZ
				8505.40.00	KZI - 4,5
30.256 HD, HDA				4222.20.00	420
				4234.30.00	GF420KR
				4283.30.00	420 10
				8505.40.00	420/210GSZ
				8505.40.00	420 10
				8505.40.00	420WGSZ
				8505.40.00	KZI - 4,5
32...					
32.292 E15,17,18,26	01.88 -			4300.90.05	430 10
32.332 E15,17,18,26	01.88 -			4301.20.00	MFZ430
32.362 E12,15,17,18	01.88 -			4346.30.00	430WGTZ
32.372 E15,17,18	01.88 -			8916.40.00	KZIZ - 5
32.422 E15,17,18	01.88 -				
32.322 E15	01.89 - 07.97			4300.90.05	430 10
				4301.20.00	MFZ430
				4346.30.00	430WGTZ
				8916.40.00	KZIZ - 5
32.362 E12,15,17,18	01.88 -			4300.90.05	430 10
				4301.20.00	MFZ430
				4346.30.00	430WGTZ
				8916.40.00	KZIZ - 5
33...					
33.273 E69				4300.90.49	430 10
33.403 E69				4301.20.00	MFZ430
33.423 E69				4346.30.00	430WGTZ
33.463 E69				8916.40.00	KZIZ - 5
35...					
35.292 E15,17,18,26	01.88 -			4300.90.05	430 10
35.332 E14,15,17,18,26	01.88 -			4301.20.00	MFZ430
35.362 E15,17,18	01.88 -			4346.30.00	430WGTZ
35.372 E15,17,18	01.88 -			8916.40.00	KZIZ - 5
35.422 E15,17,18	01.88 -				







Vehicle list

					
---	---	---	--	---	---

























ÖSTERREICHISCHE AUTOMOBILFABRIK (ÖAF)

35...					
35.322 E15	01.89 - 07.97		 4300.90.05  4301.20.00  4346.30.00  8916.40.00	430 10 MFZ430 430WGTZ KZIZ - 5	
35.373 E68 35.403 E68 35.423 E68 35.463 E68	01.94 - 01.94 - 01.94 - 01.94 -	D 2866 LF20 D 2866 LF21 D 2866 LF22 D 2876 LF 02	 4300.90.49  4301.20.00  4346.30.00  8916.40.00	430 10 MFZ430 430WGTZ KZIZ - 5	
36...					
36.372 E26 36.422 E26	01.90 - 01.90 -		 4300.90.05  4301.20.00  4346.30.00  8916.40.00	430 10 MFZ430 430WGTZ KZIZ - 5	
37...					
37.373 E68 37.403 E68 37.423 E68 37.463 E68			 4300.90.05  4301.20.00  4346.30.00  8916.40.00	430 10 MFZ430 430WGTZ KZIZ - 5	
41...					
41.292 E15,17,18,26 41.332 E15,17,18,26 41.362 E12,15,17,18,26 41.372 E12,15,17,18,26 41.422 E12,15,17,18	01.88 - 01.88 - 01.88 - 01.88 -		 4300.90.05  4301.20.00  4346.30.00  8916.40.00	430 10 MFZ430 430WGTZ KZIZ - 5	
41.322 E15	01.89 - 07.97		 4300.90.05  4301.20.00  4346.30.00  8916.40.00	430 10 MFZ430 430WGTZ KZIZ - 5	
41.373 E68,78 41.403 E68,78 41.423 E68,78 41.463 E68,78			 4300.90.05  4301.20.00  4346.30.00  8916.40.00  4300.90.49  4301.20.00  4346.30.00  8916.40.00	430 10 MFZ430 430WGTZ KZIZ - 5 430 10 MFZ430 430WGTZ KZIZ - 5	
41.462 E12 41.502 E12	01.85 - 01.85 -		 4000.90.01 $\Delta \nabla \text{HD}$  4001.10.00  4010.30.00  8916.40.00  4300.90.05  4301.20.00  4346.30.00  8916.40.00	400 10 MFZ2/400X 400WGVZ KZIZ - 5 430 10 MFZ430 430WGTZ KZIZ - 5	
42...					
42.373 E78 42.403 E78 42.423 E78 42.463 E78	01.94 - 01.94 - 01.94 - 01.94 -		 4300.90.05  4301.20.00  4346.30.00  8916.40.00	430 10 MFZ430 430WGTZ KZIZ - 5	
47...					
47.292 E15,17,18,26 47.332 E15,17,18 47.362 E12,15,17,18	01.88 - 01.88 - 01.88 -		 4300.90.05  4301.20.00  4346.30.00  8916.40.00	430 10 MFZ430 430WGTZ KZIZ - 5	



Vehicle list

					
---	---	---	--	---	---







ÖSTERREICHISCHE AUTOMOBILFABRIK (ÖAF)

48...					
48.372 E17,18	01.89 -			4300.90.05	430 10
48.402 E18	01.89 -			4301.20.00	MFZ430
48.422 E17,18	01.89 -			4346.30.00	430WGTZ
				8916.40.00	KZIZ - 5
E 2000					
26.414.DFARC E40	01.97 - 03.04	D 2866 LF 03		4300.90.05	430 10
26.414.DFRC E40	01.97 - 03.04	D 2866 LF 25		4301.20.00	MFZ430
26.464.DFARC E40	01.97 - 03.04			4346.30.00	430WGTZ
26.464.DFLRS E40	01.97 - 03.04			8916.40.00	KZIZ - 5
F...					
FKD -160				3588.30.00	350 10
				8505.40.00	350GSZ
					KZI - 4,5
K...					
K 16-180E				3588.30.00	350 10
				8505.40.00	350GSZ
					KZI - 4,5
KA 200				3804.20.00	380
					G380KR
L...					
L 200				3804.20.00	380
L 200 /1-3					G380KR
LA 200					
LA 200 /1 A					
LA 200 /1-2					
O...					
ORZT 66 L				4201.20.00	420
				4203.30.00	G420KR
					420 10
					420GS
S...					
SAF 200 /38				3804.20.00	380
SAFD 200 /33					G380KR
SF 200 /33					
SF 200 /36					
T...					
TSH 158				4201.20.00	420
TSH 158 /1				4203.30.00	G420KR
					420 10
					420GS
Z...					
Z 200				3804.20.00	380
ZA 200					G380KR
ZA 200 /1-4					
ZAFD 200 /36					

OTOYOL (TÜRKİYE)



35-50 NC ESKI MODEL					
35-50 NC				2514.20.00	250
				2504.30.00	H250K
					250 10
					250CBL

Vehicle list



					
---	---	---	--	---	---

OTOYOL (TÜRKİYE)

85.12 5 ILERI

85.12 TURBO			 3169.20.00	310 MF310	
			 3113.30.00	310 10 310GSBL	

120.14 6 ILERI

IVECO 120.14-M29-50			 3189.20.00	310 MFZ 310	
			 3133.30.00	310 10 310GSBL	

PERLINI

T 15





T 15 DP 218			 4201.20.00	420 G420KR	
-------------	--	--	---	----------------------	--

T 20





T 20 Typ 225			 4201.20.00	420 G420KR	
--------------	--	--	---	----------------------	--

PEUGEOT

J5 Box (280L) 09.81 - 09.90

1.8	01.83 - 11.88	169B (XM7T)	 2150.90.18	215 21 CP215 215CE KZIS - 0	
			 2185.20.00		
			 2178.30.00		
			 3211.40.00		

J5 Flatbed / Chassis (280L) 09.81 - 09.90

2.0	01.86 - 11.88 01.86 - 11.88	170B (XN1T)	 2150.90.18	215 21 CP215 215CE KZIS - 0	
			 2185.20.00		
			 2178.30.00		
			 3211.40.00		



J5 Box (290L) 09.90 - 03.94

1.9	10.90 -	D9B (XUD9A)	 2150.90.16	215 21 CP215	
			 2185.20.00		



J5 Flatbed / Chassis (290L) 09.90 - 03.94

1.9 D	10.90 -	D9B (XUD9A)	 2150.90.16	215 21 CP215	
			 2185.20.00		







J7 Box 08.68 - 03.80

1.5	08.68 - 07.70	XB5P	 2185.20.00	215 CP215	
			 2198.30.00		
1.6, 44kW	08.68 - 03.80	XC5P		215 23 215CE	
1.6, 50kW	08.68 - 03.80	XC7P			
1.8	07.70 - 03.80	XD2P94			
1.9 D	08.68 - 07.78	XDP88			
2.1 D	08.68 - 07.77	XDP90			
2.3 D	07.77 - 03.80	XM7P			

J7 Flatbed / Chassis 08.68 - 03.80



1.6, 44kW	07.70 - 03.80	XC5P	 2185.20.00	215 CP215	
			 2198.30.00		
1.6, 50kW	08.68 - 07.70	XC7P		215 23 215CE	
1.8	07.70 - 03.80	XD2P94			
1.9 D	08.68 - 07.78	XDP88			
2.1 D	08.68 - 07.77	XDP90			
2.3 D	07.77 - 03.80	XM7P			

Vehicle list



					
---	---	---	--	---	---

PEUGEOT

J9 Box 03.80 - 06.87









1.6	03.80 - 06.87	XC7P		2185.20.00	215 CP215	
2.0	03.80 - 06.87	XD2PX94				
2.1 D	03.80 - 06.87	XD3P		2198.30.00	215 23 215CE	
2.3 D	03.80 - 07.82	XDPX90				
2.5 D	07.82 - 06.87	XN1P				

J9 Flatbed / Chassis 03.80 - 06.87





2.0	03.80 - 06.87	XD2PX94		2185.20.00	215 CP215	
2.3 D	03.80 - 07.82	XD3P				
2.5 D	07.82 - 06.87	XN1P		2198.30.00	215 23 215CE	

RENAULT

















MASTER I Box (T_) 08.80 - 07.98

28-35 2.1 D	08.80 - 07.98	J8S330		2150.90.07  2185.20.00  2178.30.00  3233.40.00	215 21 CP215 215CE KZAS - 0B	- To model year: 02.1989
28-35 2.4 D	08.80 - 08.89	8140.61.2300 S8U 731		2150.90.07  2185.20.00  2178.30.00  3233.40.00	215 21 CP215 215CE KZAS - 0B	









MASTER I Flatbed / Chassis(P_) 07.80 - 07.98

28-35 2.0	10.82 - 09.86	829 730		2185.20.00	215 CP215	
				3233.40.00	KZAS - 0B	
28-35 2.5 D	09.80 - 07.98	8140.61.2300 S8U 731		2185.20.00	215 CP215	- To model year: 03.1981-02.1989
				3233.40.00	KZAS - 0B	- To model year: 03.1981-02.1989







TRAFIC Box (T1, T3, T4) 03.80 - 04.89

1.6	01.83 - 06.86	A1M 707		2000.90.36  2042.20.00  2045.30.00  3216.40.00	200 21 CP20 200D KZAS - 0	
1.6 4x4	08.85 - 06.86	A1M 708				
1.7	06.86 - 04.89	F1N 724		2000.90.19  2023.20.00  2034.30.00  3224.40.00	200 26 DB200 200CE KZAS - 00	
2.0	06.86 - 04.89	J5R 716		2150.90.42  2185.20.00  2178.30.00  3216.40.00	215 21 CP215 215CE KZAS - 0	
2.0 4x4	06.86 - 04.89	J5R 722 J5R 726				
2.1 D	09.80 - 04.89	852 750		2000.90.36  2042.20.00  2045.30.00  3216.40.00	200 21 CP20 200D KZAS - 0	
2.1 D 4x4	11.86 - 04.89					





















































TRAFIC Flatbed / Chassis (P6) 03.80 - 04.89

1.6	03.80 - 06.86	841 705		2000.90.36  2042.20.00  2045.30.00  3216.40.00	200 21 CP20 200D KZAS - 0	
2.1 D	03.80 - 04.89	852 720 A1M 705				
1.7	06.86 - 04.89	F1N 722		2000.90.19  2023.20.00  2034.30.00  3224.40.00	200 26 DB200 200CE KZAS - 00	







Vehicle list

					
---	---	---	--	---	---

RENAULT





TRAFIC Flatbed / Chassis (P6)		03.80 - 04.89				
2.0, 59kW	03.80 - 04.89	829 720		2150.90.42	215 21	
2.0, 63kW	03.80 - 12.86	829 721 J5R 726	  	2185.20.00 2178.30.00 3216.40.00	CP215 215CE KZAS - 0	
2.5 D	03.80 - 04.89	8140.61.240 S8U 720 S8U 722		2150.90.42	215 21	
			  	2185.20.00 2178.30.00 3216.40.00	CP215 215CE KZAS - 0	
TRAFIC Box (TXX)		05.89 - 03.01				
1.7	08.92 - 08.94	F1N 720		2000.90.19	200 26	
			  	2023.20.00 2034.30.00 3224.40.00	DB200 200CE KZAS - 00	
2.0	05.89 - 08.90	J5R 716		2150.90.42	215 21	
2.2, 70kW	05.89 - 06.94	J7T 600	  	2185.20.00 2178.30.00 3216.40.00	CP215 215CE KZAS - 0	
2.2 4x4, 70kW	05.89 - 06.94	J7T 780				
2.2 4x4, 74kW	06.94 - 10.97					
2.2, 74kW	06.94 - 10.97	J7T 600		2000.90.40	200 21	
			  	2042.20.00 2080.30.00 3216.40.00	CP20 200VTB KZAS - 0	
				2150.90.42	215 21	
			  	2185.20.00 2178.30.00 3216.40.00	CP215 215CE KZAS - 0	
2.1 D, 43kW	05.89 - 06.94	852 750		2000.90.40	200 21	
			  	2042.20.00 2080.30.00 3216.40.00	CP20 200VTB KZAS - 0	
2.1 D, 47kW	06.94 - 10.97	J8S 620 J8S 758		2000.90.40	200 21	
			  	2042.20.00 2080.30.00 3216.40.00	CP20 200VTB KZAS - 0	
2.5 D	05.89 - 03.01	8140.67.2500 8140.67.2550 8140.67.2580 S8U 750 S8U 752 S8U 758		2000.90.40	200 21	- From model year: 10.1994
			  	2042.20.00 2080.30.00 3216.40.00	CP20 200VTB KZAS - 0	
TRAFIC Flatbed / Chassis (PXX)		05.89 - 03.01				
1.7	05.89 - 08.94	F1N 722		2000.90.19	200 26	
			  	2023.20.00 2034.30.00 3224.40.00	DB200 200CE KZAS - 00	
2.0 [RWD]	05.89 - 10.97	J5R 726		2150.90.42	215 21	
			  	2185.20.00 2178.30.00 3216.40.00	CP215 215CE KZAS - 0	
2.1 D [RWD], 43kW	05.89 - 06.94	852 720		2000.90.40	200 21	
			  	2042.20.00 2080.30.00 3216.40.00	CP20 200VTB KZAS - 0	
2.1 D [RWD], 47kW	06.94 - 10.97	J8S 620 J8S 758		2000.90.36	200 21	
			  	2042.20.00 2045.30.00 3216.40.00	CP20 200D KZAS - 0	

Vehicle list

					
---	---	---	--	---	---



RENAULT

TRAFIC Flatbed / Chassis (PXX) 05.89 - 03.01



2.5 D	05.89 - 03.01	8140.61.240 S8U 720 S8U 722	 2000.90.40  2042.20.00  2080.30.00  3216.40.00	200 21 CP20 200VTB KZAS - 0	- From model year: 10.1994
-------	---------------	-----------------------------------	--	---	----------------------------

RENAULT (TÜRKİYE)



MIDLINER-MIDLUM 135-140-150

MIDLINER 120-130-140 MIDLUM 135-140-150			 3162.20.00	310 MF310	
			 3162.30.00	310 10 310GTD	
			 6905.40.00	KZIS - 3	





MIDLINER 130..180/MANAGER G2XX

MIDLINER / MANAGER			 3574.20.00	350 14" MF 350	
			 3596.30.00	350 10 350WGSZ	





MIDLUM

MIDLUM 220			 3608.20.00	362 MF362	
			 3607.30.00	362 10 362WGTZ	



PREMIUM/MAGNUM/KERAX/MAXTER

PREMIUM / MAGNUM / KERAX / MAXTER			 4026.10.00	400 MFZ2/400X	- GBox: B9 - B18
			 4027.30.00	400 20 400WGVZ	- GBox: B9 - B18
			 4028.30.00	400 6 400GTZ	- GBox: B9 - B18
			 8937.40.00	KZISZ-5	- GBox: B9 - B18

PREMIUM / MAGNUM / KERAX

PREMIUM/MAGNUM/KERAX			 4026.10.00	400 MFZ2/400X	- GBox: ZF
			 4028.30.00	400 6 400GTZ	- GBox: ZF
			 4029.30.00	400 10 400GTZ	- GBox: ZF
			 8941.40.00	KZISZ-5	





PREMIUM / MAGNUM / KERAX

PREMIUM / MAGNUM / KERAX			 4311.20.00	430 MFZ430	- GBox: ZF 16S 151-181-221
			 4306.30.00	430 10 430WGTZ	- GBox: ZF 16S 151-181-221
			 8933.40.00	KZISZ - 5	- GBox: ZF 16S 151-181-221







PREMIUM / MAGNUM

			 8919.40.00	KZISZ - 5	- GBox: ZF 16S 151-181-221
--	--	--	---	-----------	----------------------------

PREM./MAG./KERAX/MANAGER/MAJC



PREMIUM / MAGNUM / KERAX/ MANAGER / MAJOR			 4311.20.00	430 MFZ430	- GBox: B9 -B18
			 4311.30.00	430 20 430W2GTZ	- GBox: B9 -B18
			 8932.40.00	KZISZ - 5	- GBox: ZF 16S 151-181-221
PREMIUM / MAGNUM			 8940.40.00	KZISZ-5	

Vehicle list

					
---	---	---	--	---	---

RENAULT (TÜRKİYE)



PREMIUM 440 - 450

PREMIUM 440 - 450	01.06 -		 4301.20.00	430 MFZ430	
			 4306.30.00	430 10 430WGTZ	
			 8933.40.00	KZISZ - 5	

PREM.420-440 INSAAT Se(PTO'lu)



PREMIUM 420 - 440			 4306.30.00	430 10 430WGTZ	
-------------------	--	--	---	--------------------------	--

PREMIUM/KERAX/MANAGER















PREMIUM / KERAX / MANAGER			 4301.20.00	430 MFZ430	- GBox: ZF 9S 109 - 6S 90 - 16S 109
			 4312.30.00	430 10 430W2GTZ	- GBox: ZF 9S 109 - 6S 90 - 16S 109

RENAULT TRUCKS

B 01.83 - 09.95

80	10.82 -		 3233.40.00	KZAS - 0B	
110	10.92 - 01.96		 2525.20.00	250 MF250	- GBox: ZF - Engine code: Sofim 8140.27

C 10.82 - 10.98

C 210.19, 18.50t	12.83 - 05.91	MIDS 06.20.30N	 3866.20.00	380 GM380K	
C 210.19, 19.00t	12.83 - 05.91				
C 230ti.19	05.90 - 07.92	MIDR06.02.26D	 3866.20.00	380 GM380K	- GBox: G406/409
C 260.19, 18.50t	10.82 - 05.91	MIDS 06.20.45 B	 4309.30.00	430 20 430WGVZ	- To model year: 04.1985 - GBox: RVI - To model year: 05.1985
			 4327.30.00	430 10 430GTZ	- Engine code: MIDS06.20.45B - GBox: Fuller - To model year: 12.1985
			 8936.40.00	KZISZ - 5	- Engine code: MIDS06.20.45B - From model year: 12.1985 - GBox: B9/B18 - GBox: RVI
			 4311.20.00	430 MFZ430	- Engine code: MIDS06.20.45B - From model year: 05.1985 - GBox: RVI
C 260.19, 19.00t	10.82 - 05.91	MIDS 06.20.45 B	 4342.30.00	430 20 430GTZ	- GBox: B9/B18; RVI - From model year: 05/1985 - To model year: 04/1985
C 260.19,C 280.19 NA02A1, NA02A1X	10.82 - 10.98				
C 260.26, Platform/Chassis, 6x4	10.82 - 05.91		 8936.40.00	KZISZ - 5	- GBox: B9/B18; RVI - From model year: 05/1985
C 260.26, Concrete Mixer, 6x4	10.82 - 05.91		 4311.30.00	430 20 430W2GTZ	- GBox: RVI - From model year: 05/1985
			 4343.30.00	430 10 430GTZ	- GBox: Fuller - To model year: 12/1985
			 4298.30.00	420 10 420GSZ	- GBox: 5S-110
C 280.19 NA02A1, NA02A1X	07.92 - 03.93	MIDS 06.20.45 B	 4342.30.00	430 20 430GTZ	- GBox: RVI - To model year: 09/1992
			 8936.40.00	KZISZ - 5	- GBox: RVI - To model year: 09/1992
			 4335.60.00 ⊕	430 MFZ430	- Transmission type: B9 - From model year: 11.1992
			 4311.30.00	430 20 430W2GTZ	- GBox: B9 - From model year: 11.1992







Vehicle list

























RENAULT TRUCKS

C 10.82 - 10.98							
C 290.19/T, Truck Tractor, 4x4 C 290.19/T, Truck Tractor, 4x2 C 290.26, C 300.26	05.86 - 05.91	MIDR 06.20.45 D		4342.30.00	430 20 430GTZ	- Engine code: MIDR062045B - GBox: RV1	
	05.86 - 05.91	MIDR 06.20.45 D3		8936.40.00	KZISZ - 5	- Engine code: MIDR062045B - GBox: RV1; B9/B18; Fuller	
	05.86 - 10.98			4311.30.00	430 20 430W2GTZ	- Engine code: MIDR062045B - GBox: B9/B18	
				4343.30.00	430 10 430GTZ	- Engine code: MIDR062045B - GBox: Fuller	
C 290.19, C 300.19 NB02A1 C 290.26, C 300.26	10.82 - 10.98	MIDR 06.20.45 D		4311.30.00	430 20 430W2GTZ	- Engine code: MIDR062045B - GBox: B9/B18	
	10.82 - 10.98	MIDR 06.20.45 D3		8936.40.00	KZISZ - 5	- Engine code: MIDR062045B - GBox: B9/B18; Fuller RTX 116.09	
				4343.30.00	430 10 430GTZ	- Engine code: MIDR062045B - GBox: Fuller	
C 300.19 NB02A1 C 300.19 NA02A1, NA02A1X, Platform/Chassis, 4x2 C 300.19 NA02A1, NA02A1X, Dump Truck, 4x2 C 300.24, Platform/Chassis, 6x4 C 300.24, Dump Truck, 6x4 C 300.26 ND02C1, ND02C1X	04.87 - 10.98	MIDR 06.20.45 D		4311.30.00	430 20 430W2GTZ	- Engine code: MIDR062045D - GBox: B9+35mm, B18; B9/B18 - To model year: 09.1992 - From model year: 10.1992	
	04.87 - 10.98	MIDR 06.20.45 D3		8936.40.00	KZISZ - 5	- Engine code: MIDR062045D - GBox: B9/B18; ZF S6-90	
	04.87 - 10.98			4342.30.00	430 20 430GTZ	- Engine code: MIDR062045D - GBox: B9/B18 - To model year: 09/1992	
	04.87 - 10.98			4300.90.48 4335.60.00 4311.30.00	430 20 MFZ430 430W2GTZ	- Engine code: MIDR062045D - GBox: B9 - From model year: 10.1992	
	04.87 - 10.98			4300.90.350 4335.60.00 4311.30.00	430 20 MFZ430 430W2GTZ	- Engine code: MIDR062045D - GBox: B9+35mm, B18 - From model year: 10/1992	
	04.87 - 10.98			4312.30.00	430 10 430W2GTZ	- Engine code: MIDR062045D - GBox: ZF S6-90; ZF 9S-109 - From model year: 10/1992	
	04.87 - 10.98			4300.90.47 4335.60.00 4312.30.00	430 10 MFZ430 430W2GTZ	- Engine code: MIDR062045D - GBox: ZF 9S-109 - From model year: 10/1992	
	04.87 - 10.98			4335.60.00	430 MFZ430	- Engine code: MIDR062045D - GBox: B9+35mm, B18; ZF 9S-109; B9 - From model year: 10/1992	
	C 340ti.17/T, 17.00t, Truck Tractor C 340ti.17/T, 17.50t, Truck Tractor C 340ti.19/T NG02A1	07.90 - 10.98	MIDR 06.20.45 E		4311.30.00	430 20 430W2GTZ	- Engine code: MIDR062045E - GBox: B9/B18 - GBox: B9+35mm, B18 - To model year: 09/1992 - From model year: 10/1992
		07.90 - 10.98	MIDR 06.20.45 E2		8936.40.00	KZISZ - 5	- Engine code: MIDR062045E - GBox: B9/B18 - To model year: 09/1992
07.90 - 10.98		MIDR 06.20.45 E3		4300.90.99 4311.26.00 4311.30.00 8938.46.00	430 20 MFZ430 430W2GTZ	- Engine code: MIDR062045E - GBox: B9+35mm, B18 - From model year: 10/1992	
				4300.90.349 4311.26.00 4311.30.00 8936.46.00	430 20 MFZ430 430W2GTZ KZISZ-5	- Engine code: MIDR062045E - GBox: B9 - From model year: 10/1992	
				4311.26.00	430 MFZ430	- Engine code: MIDR062045E - GBox: B9+35mm, B18; B9 - From model year: 10/1992	

Vehicle list

					
---	---	---	--	---	---

RENAULT TRUCKS

C		10.82 - 10.98			
C 340.19/T NG02A1	07.90 - 10.98	MIDR 06.20.45 E MIDR 06.20.45 E2 MIDR 06.20.45 E3	 4311.30.00	430 20 430W2GTZ	- Engine code: MIDR062045E - GBox: B9/B18 - GBox: B9+35mm, B18 - To model year: 09/1992 - From model year: 10/1992
			 8936.40.00	KZISZ - 5	- To model year: 09.1992 - GBox: B9/B18
			 4300.90.99  4311.26.00  4311.30.00  8938.46.00	430 20 MFZ430 430W2GTZ	- Engine code: MIDR062045E - GBox: B9+35mm,B18 - From model year: 10/1992
			 4300.90.349  4311.26.00  4311.30.00  8936.46.00	430 20 MFZ430 430W2GTZ KZISZ-5	- Engine code: MIDR062045E - GBox: B9 - From model year: 10/1992
CCH 300.26 ND02C1, ND02C1X, Platform/Chassis, 6x4 CCH 300.26 ND02C1, ND02C1X, Dump Truck, 6x4 CCH 300.30 ND02C1, ND02C1X, Platform/Chassis, 6x4 CCH 300.30 ND02C1, ND02C1X, Dump Truck, 6x4	09.90 - 03.93	MIDR 06.20.45 D	 4311.30.00	430 20 430W2GTZ	- Engine code: MIDR062045D - GBox: B9/B18 - GBox: B9+35mm, B18 - To model year: 09/1992 - From model year: 10/1992
	09.90 - 03.93		 8936.40.00	KZISZ - 5	- Engine code: MIDR062045D - GBox: B9/B18 - GBox: ZF S6-90 - To model year: 09/1992 - From model year: 10/1992
	09.90 - 03.93		 4342.30.00	430 20 430GTZ	- Engine code: MIDR062045D - GBox: B9/B18 - To model year: 09/1992
	09.90 - 03.93		 4300.90.48 ⊕  4335.60.00  4311.30.00	430 20 MFZ430 430W2GTZ	- Engine code: MIDR062045D - GBox: B9 - From model year: 10/1992
	09.90 - 03.93		 4300.90.350 ⊕  4335.60.00  4311.30.00	430 20 MFZ430 430W2GTZ	- Engine code: MIDR062045D - GBox: B9+35mm,B18 - From model year: 10/1992
	09.90 - 03.93		 4312.30.00	430 10 430W2GTZ	- Engine code: MIDR062045D - GBox: ZF S6-90 - From model year: 10/1992
	09.90 - 03.93		 4300.90.47 ⊕  4335.60.00  4312.30.00	430 10 MFZ430 430W2GTZ	- Engine code: MIDR062045D - GBox: ZF 9S-109 - From model year: 10/1992

Vehicle list

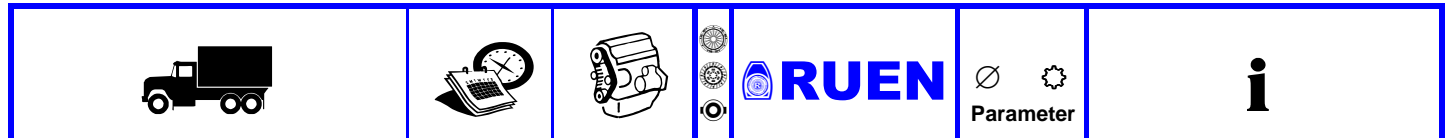

RENAULT TRUCKS

C - Serie

01.13 -

250P 21DM086STD00	01.13 -	DTI8-122HQ	3950.90.20	10	- GBox: ZF6S 1000 TO
250P, 250PK 21DJ086K0000, 21DJ086STD00	01.13 -	DTI8-122HR	3961.20.00	MF395	
280P 21DM086STD01	01.13 -	DTI8-122HS	3973.30.00	395WGTZ	
280P, 280PK 21DJ086K0001, 21DJ086STD01	01.13 -		8543.40.00	KZIS-4	
280P, 280PK 21DN086STD00, 21DN086K0000	01.13 -		3950.90.24	395 10	- GBox: ZF6AS 1000 TO
320P 21DM086STD02	01.13 -		3961.20.00	MF395	
320P, 320PK 21DJ086K0002, 21DJ086STD02	01.13 -		3974.30.00	395WGTZ	
320P, 320PK 21DN086STD01, 21DN086K0001	01.13 -		8543.40.00	KZIS-4	
250FG P	01.13 -				
250FG P, 250FG PK	01.13 -				
280FG P	01.13 -				
280FG P, 280FG PK, Platform/Chassis, 4x2	01.13 -				
280FG P, 280FG PK, Platform/Chassis, 6x4	01.13 -				
320FG P	01.13 -				
320FG P, 320FG PK, Platform/Chassis, 4x2	01.13 -				
320FG P, 320FG PK, Platform/Chassis, 6x4	01.13 -				

Vehicle list



RENAULT TRUCKS

C - Serie

01.13 -

380P 30CM016STD00	01.13 -	DTI11-122HH	4300.90.129 ⊕	430 24	- Engine code: DTI 11
380P, 380PK 30CJ016STD00, 30CJ016K0000	01.13 -	DTI11-122HI	4382.60.00	MFZ430	- Engine code: DTI 13
380P, 380PK 30CN016STD00, 30CN016K0000	01.13 -	DTI11-122HJ	4398.30.00	430WGTZ	- GBox: MT 2214B / MT 2514B, MTO 2214B/MTO 2514B
380P, 380PK, 380P XLOAD 30CS016K0000, 30CS016XLD00, 30CS016STD00	01.13 -	DTI13-122HK	8641.47.00	PHIS-6/38	- Engine code: DTI 11
380T, 380TK 30CA016K0000, 30CA016STD00	01.13 -	DTI13-122HL			- Engine code: DTI 13
380T, 380TK 30CE016STD00, 30CE016K0000	01.13 -	DTI13-122HM			- GBox: AT 2412/E /AT 2612/E, ATO 2612/E
430P 30CM016STD01	01.13 -				
430P, 430PK 30CJ016K0001, 30CJ016STD01	01.13 -				
430P, 430PK 30CN016K0001	01.13 -				
430P, 430PK, 430P XLOAD 30CS016K0001, 30CS016STD01, 30CS016XLD01	01.13 -				
430T, 430TK 30CA016K0001, 30CA016STD01	01.13 -				
430T, 430TK 30CE016STD01, 30CE016K0001	01.13 -				
440P 30CM036STD00	01.13 -				
440P, 440PK 30CJ036STD00, 30CJ036K0000	01.13 -				
440P, 440PK 30CN036STD00, 30CN036K0000	01.13 -				
440P, 440PK 30CS036K0000, 30CS036STD00	01.13 -				
440T, 440TK 30CA036STD00, 30CA036K0000	01.13 -				
440T, 440TK 30CE036STD00, 30CE036K0000	01.13 -				
460P 30CM016STD02	01.13 -				
460P, 460PK 30CJ016K0002, 30CJ016STD02	01.13 -				
460P, 460PK 30CN016K0002, 30CN016STD02	01.13 -				
460P, 460PK, 460P XLOAD 30CS016K0002, 30CS016STD02, 30CS016XLD02	01.13 -				
460T, 460TK 30CA016STD02, 30CA016K0002	01.13 -				
460T, 460TK 30CE016K0002, 30CE016STD02	01.13 -				
480P 30CM036STD01	01.13 -				
480P, 480PK 30CJ036STD01, 30CJ036K0001	01.13 -				
480P, 480PK 30CN036K0001, 30CN036STD01	01.13 -				
480P, 480PK 30CS036K0001, 30CS036STD01	01.13 -				
480T, 480TK 30CA036STD01, 30CA036K0001	01.13 -				
480T, 480TK 30CE036STD01, 30CE036K0001	01.13 -				
520P 30CM036STD02	01.13 -				
520P, 520PK 30CJ036K0002, 30CJ036STD02	01.13 -				

Vehicle list



RENAULT TRUCKS

C - Serie		01.13 -				
380FG P, Platform/Chassis, 4x2	01.13 -	DTI11-122HH		4300.90.129 ⊕	430 24	- Engine code: DTI 11
380FG P, Platform/Chassis, 6x2	01.13 -	DTI11-122HI		4382.60.00	MFZ430	- GBox: MT 2214B / MT 2514B, MTO 2214B/MTO 2514B
380T	01.13 -			4398.30.00	430WGTZ	
430FG P, Platform/Chassis, 4x2	01.13 -			8641.47.00	PHIS-6/38	- Engine code: DTI 11
430FG P, Platform/Chassis, 6x2	01.13 -					- GBox: AT 2412/E / AT 2612/E, ATO 2612/E
430T	01.13 -					
520P, 520PK 30CN036STD02, 30CN036K0002	01.13 -	DTI113-122HM		4300.90.129 ⊕	430 24	- Engine code: DTI 13
520P, 520PK 30CS036STD02, 30CS036K0002	01.13 -			4382.60.00	MFZ430	- GBox: MTO 2514B
520T, 520TK 30CA036K0002, 30CA036STD02	01.13 -			4398.30.00	430WGTZ	
520T, 520TK 30CE036K0002, 30CE036STD02	01.13 -			8641.47.00	PHIS-6/38	- Engine code: DTI 13
						- GBox: AT2612/E / ATO2612/E
series CBH						
CBH 280.26, Platform/Chassis, 6x6	04.86 - 10.92	MIDS 06.35.40 D		4327.30.00	430 10	- GBox: Fuller RTO 9509
CBH 280.26, Dump Truck, 6x4	04.86 - 10.92				430GTZ	- GBox: Fuller RTX 113.09
CBH 280.26, Platform/Chassis, 6x4	04.86 - 10.92			4311.30.00	430 20	- GBox: RVI
CBH 280.26/T	04.86 - 10.92				430W2GTZ	
CBH 280.34, Platform/Chassis, 6x4	04.86 - 10.92			8936.40.00	KZISZ - 5	- GBox: RVI
CBH 280.34, Platform/Chassis, 6x6	04.86 - 10.92					- GBox: Fuller RTX 113.09
CBH 280.34, Dump Truck, 6x4	04.86 - 10.92					
CBH 280.34/T	04.86 - 10.92					
CBH 320.24, Platform/Chassis, 6x4	10.92 - 10.98	MIDR 06.35.40 M3		4300.90.48 ⊕	430 20	- GBox: B9
CBH 320.24, Dump Truck, 6x4	10.92 - 10.98			4335.60.00	MFZ430	
CBH 320.24/T	10.92 - 10.98			4311.30.00	430W2GTZ	
CBH 320.26 NE02H2, NE02H3, Platform/Chassis, 6x6	10.92 - 10.98			4311.26.00 ⊖	430	- GBox: B9+35mm, B18
CBH 320.26 ND02H2, ND02H3, Dump Truck, 6x4	10.92 - 10.98			4311.30.00	430 20	- GBox: B9+35mm, B18
CBH 320.26 NE02H2, NE02H3, Dump Truck, 6x6	10.92 - 10.98				430W2GTZ	
CBH 320.26 ND02H2, ND02H3, Platform/Chassis, 6x4	10.92 - 10.98					
CBH 320.26/T ND02H2, ND02H3	10.92 - 10.98					
CBH 320.26/T NE02H2, NE02H3	10.92 - 10.98					
CBH 320.34 NE02H2, NE02H2E, NE02H3, Dump Truck, 6x6	10.92 - 10.98					
CBH 320.34 ND02H2, ND02H3, ND02H2E, Dump Truck, 6x4	10.92 - 10.98					
CBH 320.34 NE02H2, NE02H2E, NE02H3, Platform/Chassis, 6x6	10.92 - 10.98					
CBH 320.34 ND02H2, ND02H3, ND02H2E, Platform/Chassis, 6x4	10.92 - 10.98					
CBH 320.34/T NE02H2, NL02H2E, NE02H3	10.92 - 10.98					
CBH 320.34/T ND02H2, NK02H2E, ND02H3	10.92 - 10.98					
CBH 340.26, Platform/Chassis, 6x4	02.88 - 10.92	MIDR 06.35.40 G		4311.30.00	430 20	
CBH 340.26, Dump Truck, 6x4	02.88 - 10.92				430W2GTZ	
				8936.40.00	KZISZ - 5	- GBox: B9/B18
						- GBox: RVI
						- For: TELMA
CBH 350.26, Dump Truck, 6x4	05.90 - 01.93	MIDR 06.35.40 G		4311.30.00	430 20	
CBH 350.26, Platform/Chassis, 6x6	05.90 - 01.93				430W2GTZ	
CBH 350.26, Platform/Chassis, 6x4	05.90 - 01.93			8936.40.00	KZISZ - 5	- To model year: 10.1992
CBH 350.34, Dump Truck, 6x4	05.90 - 01.93					- GBox: B9/B18
CBH 350.34, Platform/Chassis, 6x4	05.90 - 01.93					

Vehicle list

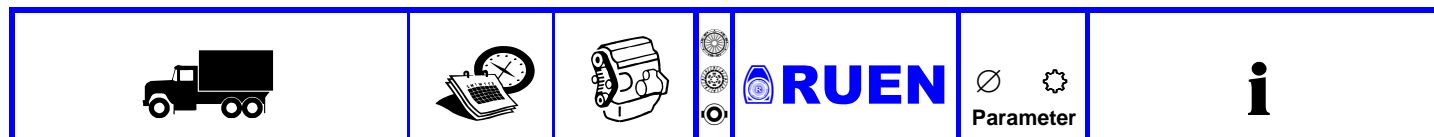

RENAULT TRUCKS







series CBH

CBH 380.26, Platform/Chassis, 6x4	01.90 - 10.92	MIDR 06.35.40 H		4311.30.00	430 20 430W2GTZ	
CBH 380.26, Dump Truck, 6x4	01.90 - 10.92					
CBH 380.34, Platform/Chassis, 6x4	01.90 - 10.92			8936.40.00	KZISZ - 5	- GBox: B9/B18
CBH 380.34, Dump Truck, 6x4	01.90 - 10.92					
CBH 385.24, Dump Truck, 6x6	10.92 - 10.98	MIDR 06.35.40 N/3		4311.30.00	430 20 430W2GTZ	
CBH 385.24, Platform/Chassis, 6x4	10.92 - 10.98					
CBH 385.24, Dump Truck, 6x4	10.92 - 10.98			8936.40.00	KZISZ - 5	- To model year: 10.1992 - GBox: B9/B18
CBH 385.24, Platform/Chassis, 6x6	10.92 - 10.98					
CBH 385.26, Platform/Chassis, 6x6	10.92 - 10.98					
CBH 385.26, Dump Truck, 6x6	10.92 - 10.98					
CBH 385.26 NE02H2, NE02H3, Platform/Chassis, 6x4	10.92 - 10.98					
CBH 385.26 NE02H2, NE02H3, Dump Truck, 6x4	10.92 - 10.98					
CBH 385.26/T	10.92 - 10.98					
CBH 385.26/T NK02H2	10.92 - 10.98					
CBH 385.34 NE02H2E, Platform/Chassis, 6x6	10.92 - 10.98					
CBH 385.34 NE02H2E, Dump Truck, 6x6	10.92 - 10.98					
CBH 385.34 NE02H2, NE02H3, ND02H2E, Platform/Chassis, 6x4	10.92 - 10.98					
CBH 385.34 NE02H2, NE02H3, ND02H2E, Dump Truck, 6x4	10.92 - 10.98					
CBH 385.34/T NL02H2E	10.92 - 10.98					
CBH 385.34/T NK02H2, NK02H2E	10.92 - 10.98					

series CLM

CLM 280	11.92 -			4311.30.00	430 20 430W2GTZ	- Engine code: MIDS063540 - GBox: B9/B18
				8936.40.00	KZISZ - 5	- Engine code: MIDS063540 - GBox: B9/B18 - GBox: Eaton RTX 11609B
				4343.30.00	430 10 430GTZ	- Engine code: MIDS063540 - GBox: Eaton RTX 11609B
CLM 280.19/T	04.86 - 10.92	MIDS 06.35.40 D		4311.30.00	430 20 430W2GTZ	- Engine code: MIDS063540 - GBox: B9/B18
				8936.40.00	KZISZ - 5	- Engine code: MIDS063540 - GBox: B9/B18 - GBox: Eaton RTX 11609B
				4343.30.00	430 10 430GTZ	- Engine code: MIDS063540 - GBox: Eaton RTX 11609 B
CLM 320.19/T NG02H2E CLM 320.25/T NG02H2E	10.92 - 10.98 10.92 - 10.98	MIDR 06.35.40 M3		4300.90.48 ⊕ 4335.60.00 4311.30.00	430 20 MFZ430 430W2GTZ	- GBox: B9
				4300.90.350 ⊕ 4335.60.00 4311.30.00	430 20 MFZ430 430W2GTZ	- GBox: B9+35mm,B18
CLM 340 T CLM 350 CLM 380.19/T	- 09.92 - 09.92 05.91 - 10.92	MIDR 06.35.40 H		4311.30.00	430 20 430W2GTZ	- Engine code: MIDR063540 - GBox: B9/B18
				8936.40.00	KZISZ - 5	- Engine code: MIDR063540 - GBox: B9/B18
CLM 385.19/T NG02H2E, NG02H2 CLM 385.22/T NG02H2 CLM 385.25/T NG02H2E, NG02H2	10.92 - 10.98 10.92 - 10.98 10.92 - 10.98	MIDR 06.35.40 N/3		4000.90.19 ⊕ 4036.10.00 4027.30.00	400 20 MFZ2/400X 400WGVZ	- GBox: B9/B18

Vehicle list

					
---	---	---	--	---	---



RENAULT TRUCKS

series CLR

220 220 (11G.) 230 CLR 230.19	10.92 - 09.90 - 10.98	MIDR 06.02.26 D	 3866.20.00	380 GM380K	
--	--------------------------	--------------------	---	----------------------	--

D - Serie

01.13 -

10 P 210 40J20560LD00 10 P 240 40J20560LD01 12 P 210 12 P 210 40J20562MD00, 40J20562LD00 12 P 240 12 P 240 40J20562MD01, 40J20562LD01 13 P 210, 13 KP 210 40J40563HD00, 40J40563MD00, 40J40563HK00 13 P 240, 13 KP 240 40J40563HD01, 40J40563HK01, 40J40563MD01 14 P 210, 14 KP 210 40J40564HK00, 40J40564HD00, 40J40564MD00 14 P 240, 14 KP 240 40J40564MD01, 40J40564HK01, 40J40564HD01 16 P 210, 16 KP 210 40J60566MD00, 40J60566HD00, 40J60566HK00 16 P 240, 16 KP 240 40J60566HK01, 40J60566HD01, 40J60566MD01	01.13 - 01.13 - 01.13 - 01.13 - 01.13 - 01.13 - 01.13 - 01.13 - 01.13 - 01.13 - 01.13 - 01.13 - 01.13 - 01.13 - 01.13 - 01.13 - 01.13 - 01.13 - 01.13 -	DTI5-122HN DTI5-122HP	 3961.20.00  8543.40.00	395 MF395 KZIS-4	- GBox: 6AS 800TO, 6AS 1000TO, 6S 800, 6S 1000TO - GBox: 6AS 800TO, 6AS 1000TO, 6S 800, 6S 1000TO
--	---	--------------------------	--	-----------------------------------	--

Vehicle list

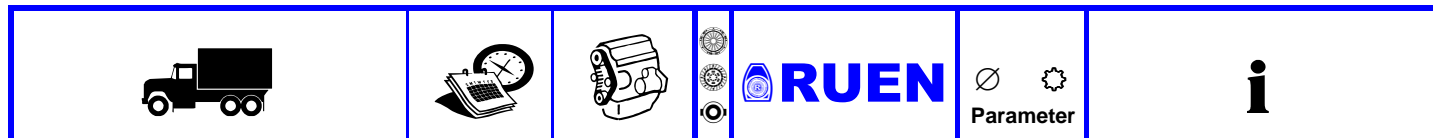

RENAULT TRUCKS

D - Serie

01.13 -

12 KP 250	01.13 -	DTI 3	3950.90.20	10	- GBox: ZF6S 1000 TO
12 KP 280	01.13 -	DTI8-122HQ	3961.20.00	MF395	
12 P 250 40J20862MD00	01.13 -	DTI8-122HR	3973.30.00	395WGTZ	
12 P 280 40J20862MD01	01.13 -	DTI8-122HS	8543.40.00	KZIS-4	
13 P 250, 13 KP 250 40J40863HK00, 40J40863MD00, 40J40863HD00	01.13 -		3950.90.24	395 10	- GBox: ZF6AS 1000 TO
13 P 280, 13 KP 280 40J40863HD01, 40J40863MD01, 40J40863HK01	01.13 -		3961.20.00	MF395	
14 KP 250	01.13 -		3974.30.00	395WGTZ	
14 P 250	01.13 -		8543.40.00	KZIS-4	
14 P 250, 14 KP 250 40J40864HK00, 40J40864HD00, 40J40864MD00	01.13 -				
14 P 280, 14 KP 280	01.13 -				
14 P 280, 14 KP 280 40J40864MD01, 40J40864HD01, 40J40864HK01	01.13 -				
16 KP 250	01.13 -				
16 KP 280	01.13 -				
16 P 250	01.13 -				
16 P 250, 16 KP 250 40J60866MD00, 40J60866HD00, 40J60866HK00	01.13 -				
16 P 280, 16 KP 280 40J60866HD01, 40J60866HK01, 40J60866MD01	01.13 -				
18 ACCESS P 280	01.13 -				
18 ACCESS P 320	01.13 -				
18 P 250 20DJ086REF00	01.13 -				
18 P 250, 18 KP 250 20DJ086LOW00, 20DJ086STD00	01.13 -				
18 P 280 20DJ086REF01	01.13 -				
18 P 280, 18 KP 280 20DJ086LOW01, 20DJ086STD01	01.13 -				
18 P 320 20DJ086REF02	01.13 -				
18 P 320, 18 KP 320 20DJ086LOW02, 20DJ086STD02	01.13 -				
18 T 280 20DA086STD00	01.13 -				
18 T 320 20DA086STD01	01.13 -				
25 P 250 20DM086LOW10	01.13 -				
25 P 280 20DM086LOW11	01.13 -				
25 P 320 20DM086LOW12	01.13 -				
26 ACCESS P 280	01.13 -				
26 ACCESS P 320	01.13 -				
26 P 250 20DM086REF00	01.13 -				
26 P 250, 26 KP 250 20DM086LOW00, 20DM086STD00	01.13 -				
26 P 280 20DM086REF01	01.13 -				
26 P 280, 26 KP 280 20DM086STD01, 20DM086LOW01	01.13 -				
26 P 320 20DM086REF02	01.13 -				
26 P 320, 26 KP 320 20DM086STD02, 20DM086LOW02	01.13 -				
6.5 P 150	01.16 -				
7.5 P 180	01.16 -				
18 P 380, 18 FG 380	01.13 -	DTI11-122HH	4300.90.129 ⊕	430 24	- Engine code: DTI 11
18 P 430, 18 FG 430	01.13 -	DTI11-122HI	4382.60.00	MFZ430	- GBox: MT 2214B / MT 2514B, MTO 2214B/MTO 2514B
18 T 380	01.13 -		4398.30.00	430WGTZ	
18 T 430	01.13 -		8641.47.00	PHIS-6/38	- Engine code: DTI 11 - GBox: AT 2412/E /AT 2612/E, ATO 2612/E
series F					
620			3587.30.00	350 10 350GSZ	

Vehicle list



RENAULT TRUCKS

G 10.82 - 09.91						
G 210.16	11.83 - 02.90	MIDS 06.20.30 N MIDS 06.20.30 N1		3866.20.00	380 GM380K	- GBox: G406/409
G 230.11	01.85 - 05.90	MIDS 06.20.30 P		3866.20.00	380 GM380K	
G 230.13	01.85 - 05.90					
G 230.15	01.85 - 05.90					
G 230.15/T	01.85 - 05.90					
G 230.16, 16.00t, Platform/Chassis	01.85 - 05.90					
G 230.16, 16.50t, Platform/Chassis	01.85 - 05.90					
G 230.17, 17.00t, Platform/Chassis	01.85 - 05.90					
G 230.17, 17.50t, Platform/Chassis	01.85 - 05.90					
G 230.17, 17.00t, Dump Truck	01.85 - 05.90					
G 230.17/T	01.85 - 05.90					
G 230ti.13	02.90 - 08.91	MIDR 06.02.26 D		3866.20.00	380 GM380K	- GBox: G406/409
G 230ti.15	02.90 - 08.91					
G 230ti.16, 16.00t, Platform/Chassis	02.90 - 08.91					
G 230ti.17	02.90 - 08.91					
G 230ti.18, Platform/Chassis, 4x2	02.90 - 08.91					
G 230ti.18, Dump Truck, 4x2	02.90 - 08.91					
G 260.15/T	10.82 - 05.90	MIDS 06.20.45		8936.40.00	KZISZ - 5	- From model year: 04/1985 - GBox: RVI
G 260.16, 16.00t, Platform/Chassis	10.82 - 05.90	MIDS 06.20.45 B		4342.30.00	430 20 430GTZ	- Engine code: MIDSO62045 - GBox: RVI
G 260.16, 16.50t, Platform/Chassis	10.82 - 05.90					- From model year: 04/1985
G 260.17, 17.00t, 4x2	10.82 - 05.90			4343.30.00	430 10 430GTZ	- Engine code: MIDSO62045 - GBox: Fuller - To model year: 05/1985
G 260.17, Dump Truck, 4x2	10.82 - 05.90					
G 260.17/T	10.82 - 05.90					
G 260.19, 19.00t, 4x2	10.82 - 05.90					
G 260.22/T	10.82 - 05.90					
G 260.24 CIT	10.82 - 05.90					
G 260.17	01.90 - 09.91	MIDS 06.20.45 B		4342.30.00	430 20 430GTZ	- Engine code: MIDSO62045 - GBox: RVI
				8936.40.00	KZISZ - 5	- GBox: RVI
G 280.13	01.90 - 09.91	MIDS 06.20.45 B		4342.30.00	430 20 430GTZ	- Engine code: MIDSO62045B - GBox: RVI
G 280.15	01.90 - 09.91					
G 280.15/T	01.90 - 09.91			8936.40.00	KZISZ - 5	- GBox: RVI
G 280.16, 16.00t, Platform/Chassis	01.90 - 09.91			4291.30.00	420 10 420GSZ	- Engine code: MIDSO62045B - GBox: 16S-130
G 280.16, 16.50t, Platform/Chassis	01.90 - 09.91					
G 280.18	01.90 - 09.91					
G 280.24	01.90 - 09.91					
G 280.26	01.90 - 09.91					
G 290.17/TD	11.85 - 12.89	MIDR 06.20.45		4311.30.00	430 20 430W2GTZ	- GBox: B9/B18
G 290.22/TD	11.85 - 12.89					
G 290.24	11.85 - 12.89			8936.40.00	KZISZ - 5	- GBox: B9/B18 - GBox: Eaton
G 290.24 CIT, 24.00t, Platform/Chassis	11.85 - 12.89			4343.30.00	430 10 430GTZ	- Engine code: MIDR062045 - GBox: Eaton
G 290.26, Concrete Mixer	11.85 - 12.89					

Vehicle list



RENAULT TRUCKS

G 10.82 - 09.91						
G 300.13	01.90 - 08.91	MIDR 06.20.45 D		4342.30.00	430 20 430GTZ	- GBox: B9/B18
G 300.15	01.90 - 08.91			8936.40.00	KZISZ - 5	- GBox: B9/B18 - GBox: ZF 16S-130, EatonRTXF 116
G 300.16, 16.00t, Platform/Chassis	01.90 - 08.91			4343.30.00	430 10 430GTZ	- GBox: ZF 16S-130, Eaton RTXF 116
G 300.16, 16.50t, Platform/Chassis	01.90 - 08.91			4291.30.00	420 10 420GSZ	- GBox: 16S-130+
G 300.17	01.90 - 08.91					
G 300.24, Platform/Chassis, 6x2/4	01.90 - 08.91					
G 300.24, Platform/Chassis, 6x4	01.90 - 08.91					
G 300.24, Dump Truck, 6x4	01.90 - 08.91					
G 300.25, Platform/Chassis, 6x4	01.90 - 08.91					
G 300.25, Dump Truck, 6x4	01.90 - 08.91					
G 300.26, Platform/Chassis, 6x4	01.90 - 08.91					
G 300.26, Dump Truck, 6x4	01.90 - 08.91					
G 320.19	11.88 - 05.90	MIDR 06.20.45 H		4311.30.00	430 20 430W2GTZ	- GBox: B9/B18
G 320.19 T	11.88 - 05.90			8936.40.00	KZISZ - 5	- GBox: B9/B18
G 320.24	11.88 - 05.90					
G 330.13	02.90 - 08.91	MIDR 06.20.45 H		4343.30.00	430 10 430GTZ	- GBox: Eaton RTXF 116
G 330.15	02.90 - 08.91			8936.40.00	KZISZ - 5	- GBox: Eaton RTXF 116 - GBox: B9/B18
G 330.16, 16.00t, Platform/Chassis	02.90 - 08.91			4311.30.00	430 20 430W2GTZ	- GBox: B9/B18
G 330.16, 16.50t, Platform/Chassis	02.90 - 08.91					
G 330.17	02.90 - 08.91					
G 330.17/T	02.90 - 08.91					
G 330.24	02.90 - 08.91					
G 330.26, Platform/Chassis, 6x2	02.90 - 08.91					
G 330.26, Platform/Chassis, 6x4	02.90 - 08.91					
G 170.11	05.83 - 02.90	MIDR 06.02.12 D		3574.20.00	350 14" MF 350	- Engine code: MIDR060212 - GBox: Fuller RTX 7609 - GBox: RVI
G 170.13	05.83 - 02.90			8526.40.00	KZI-4	- GBox: Fuller RTX 7609 - GBox: RVI
G 170.15	05.83 - 02.90					
G 170.16	05.83 - 02.90					
G 170.17, 16.50t, Platform/Chassis	05.83 - 02.90					
G 170.17, 17.50t, Platform/Chassis	05.83 - 02.90					
G 200.13	05.90 - 09.91	MIDR 06.02.26 H		3500.90.42	350 10	- Engine code: MIDR060226H - GBox: ZF S6-36S
G 200.15	05.90 - 09.91			3574.20.00	14" MF 350	
G 200.16, 16.00t, Platform/Chassis	05.90 - 09.91			3587.30.00	350GSZ	
G 200.16, 16.50t, Platform/Chassis	05.90 - 09.91			8525.40.00	KZIS-3	
G 200.17	05.90 - 09.91			3574.20.00	350	- Engine code: MIDR060226H - GBox: ZF S6-36S
G 200.18	05.90 - 09.91				14" MF 350	



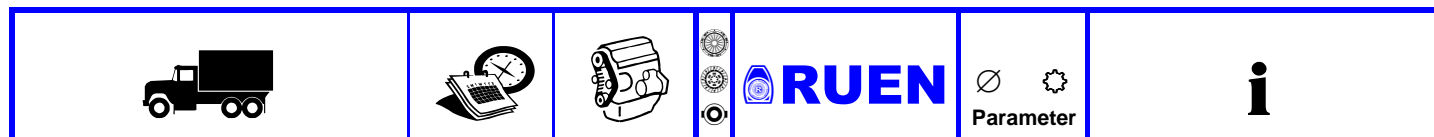



Vehicle list



























RENAULT TRUCKS

G		10.82 - 09.91	
G 210.16/T	11.83 - 02.90	MIDR 06.02.26	3866.20.00 380 GM380K - GBox: G406/409 - GBox: RVI
G 210.19	11.83 - 02.90	D	
G 210.19/T	11.83 - 02.90	MIDR 06.20.45	
G 210.19 BOM	11.83 - 02.90	MIDR 06.20.45	
G 220.17 BOM, 16.00t, Utility truck	03.91 - 09.91	D	
G 220.17 BOM, 17.50t, Utility truck	03.91 - 09.91	MIDS 06.20.30	
G 220.19 BOM	03.91 - 09.91	N	
G 230.13 SP	01.85 - 08.91	MIDS 06.20.30	
G 230.19, 18.50t, Platform/Chassis	01.85 - 05.90	N1	
G 230.19, 19.00t, Platform/Chassis	01.85 - 05.90	MIDS 06.20.30	
G 230.19/T	01.85 - 03.93	P	
G 230ti.16, 16.50t, Platform/Chassis	02.90 - 08.91	MIDS 06.20.45	
G 230ti.19, 18.50t, 4x2	02.90 - 08.91	MIDS 06.20.45	
G 230ti.19, 19.00t, 4x2	02.90 - 08.91	J	
G 230ti.19, 19.00t, 6x4	02.90 - 08.91		
G 260.19, 19.00t, 6x4	10.82 - 05.90		
G 260.19/T, Truck Tractor, 6x4	10.82 - 05.90		
G 290.19, 19.00t, 6x4	11.85 - 12.89		
G 290.19/T, Truck Tractor, 6x2	11.85 - 12.89		
G 290.19/T, Truck Tractor, 6x4	11.85 - 12.89		
G 260.17, 17.50t, 4x2	10.82 - 05.90	MIDS 06.20.45	4342.30.00 430 20 430GTZ - Engine code: MIDSO62045 - GBox: RVI - From model year: 04/1985
G 260.19, 18.50t, 4x2	10.82 - 05.90		
G 260.19, 19.00t, 4x4	10.82 - 05.90		
G 260.19/T, Truck Tractor, 4x2	10.82 - 05.90		
			8936.40.00 KZISZ - 5 - Engine code: MIDSO62045 - GBox: RVI - From model year: 04/1985
			4343.30.00 430 10 430GTZ - Engine code: MIDSO62045 - GBox: Fuller - To model year: 05/1985
G 280.19, 18.50t, Platform/Chassis	01.90 - 09.91	MIDS 06.20.45	4342.30.00 430 20 430GTZ - Engine code: MIDSO62045B - GBox: RVI
G 280.19, 19.00t, Platform/Chassis	01.90 - 09.91	B	
			8936.40.00 KZISZ - 5 - Engine code: MIDSO62045B - GBox: RVI
			4291.30.00 420 10 420GSZ - Engine code: MIDSO62045B - GBox: 16S-130
G 290.19, 18.50t, 4x2	11.85 - 12.89	MIDR 06.20.45	4311.30.00 430 20 430W2GTZ - Engine code: MIDR062045 - GBox: B9/B18 - GBox: RVI
G 290.19, 19.00t, 4x2	11.85 - 12.89	MIDR 06.20.45	
G 290.19, 19.00t, 4x4	11.85 - 12.89	E3	8936.40.00 KZISZ - 5 - Engine code: MIDR062045 - GBox: B9/B18 - GBox: Eaton - GBox: Eaton RTXF 116 - GBox: ZF 16S-130 - GBox: RVI
G 290.19/T, Truck Tractor, 4x2	11.85 - 12.89	MIDR 06.20.45	
G 290.24 CIT, 24.50t, Platform/Chassis	11.85 - 12.89	H	
G 290.26, Utility truck	11.85 - 12.89		
G 330.19, 17.50t, 4x2	02.90 - 08.91		
G 330.19, 18.50t, 4x2	02.90 - 08.91		
G 330.19, 19.00t, 4x2	02.90 - 08.91		4343.30.00 430 10 430GTZ - Engine code: MIDR062045 - GBox: Eaton - GBox: Eaton RTXF 116 - GBox: ZF 16S-130
G 340ti.19/T, G 330.19/T, G 330.17/T	01.90 - 08.91		
G 340ti.19/T, G 330.19/T	02.90 - 08.91		
G 300.15/T	01.90 - 08.91	MIDR 06.20.45	4342.30.00 430 20 430GTZ - GBox: B9/B18
G 300.19, 18.50t, Platform/Chassis	01.90 - 08.91	D	
G 300.19, 19.00t, Platform/Chassis	01.90 - 08.91		
G 300.19/T, 16.00t, Truck Tractor	01.90 - 08.91		
G 300.19/T, 19.00t, Truck Tractor	01.90 - 08.91		
G 300.26, Concrete Mixer, 6x4	01.90 - 08.91		
G 300.26 CIT	01.90 - 08.91		
G 300.26/T	01.90 - 08.91		
			8936.40.00 KZISZ - 5 - GBox: B9/B18 - GBox: ZF 16S-130, Eaton RTXF 116
			4343.30.00 430 10 430GTZ - GBox: ZF 16S-130, Eaton RTXF 116
			4291.30.00 420 10 420GSZ - GBox: 16S-130+

Vehicle list

					
---	---	---	--	---	---

RENAULT TRUCKS

GB						
191 , A	10.78 - 10.81 11.81 -		 3866.20.00	380 GM380K	- Engine code: MID06.20.30 - GBox: 6G	
131	10.78 -		 3500.90.42  3574.20.00  3587.30.00  8525.40.00	350 10 14" MF 350 350GSZ KZIS-3	- Engine code: 797 - GBox: ZFS5-35	
series GC						
190	01.75 - 12.79		 3866.20.00	380 GM380K	- GBox: 10G	
191	10.78 - 10.81 11.81 -		 3866.20.00	380 GM380K	- GBox: 6G	
191 , BOM	10.79 - 10.81 11.81 -					
series GF						
190 , A	01.75 - 12.79		 3866.20.00	380 GM380K	- GBox: 6G	
191	01.75 - 12.79					
191 (6G.)	11.81 -		 3866.20.00	380 GM380K	- GBox: BD SLO021	
GL						
GLM 280	04.86 -		 4343.30.00	430 10 430GTZ	- Engine code: MIDS063540 - GBox: Fuller RTO 9509	
			 8936.40.00	KZISZ - 5	- Engine code: MIDS063540 - GBox: Fuller RTO 9509	
GLM 280			 4343.30.00	430 10 430GTZ	- Engine code: MIDS063540 - GBox: Fuller RTO 9509 - To model year: 03/1986	
			 4342.30.00	430 20 430GTZ	- Engine code: MIDS063540 - GBox: RVI, Fuller RTO 9505 - From model year: 04/1986	
			 8936.40.00	KZISZ - 5	- GBox: RVI / Fuller RTO 9509 - From model year: 04/1986	
GLR 190 , A	10.78 -		 3866.20.00	380 GM380K	- GBox: 6Gang/Manual	
GL 900 E (5G.)	06.75 - 12.79		 3571.30.00	350 10 350	- Engine code: MID042030 - GBox: ZF	
			 3587.30.00	350 10 350GSZ	- Engine code: MID042030 - GBox: ZF	
GR						
191 , A, B	10.78 -		 3866.20.00	380 GM380K	- GBox: 6 Gang / Manual	
280 , A, B	01.73 - 12.82		 4342.30.00	430 20 430GTZ		
series GRH						
235 R 6x4 305 6x4	10.78 - 10.77 - 12.80		 4342.30.00	430 20 430GTZ	- GBox: B9.150	
series H...						
HB 15, 17, 19, 26	01.78 - 12.80		 3563.20.00	350 GMF350		
			 8505.40.00	KZI - 4,5		
HM 15, 17, 19, 26	01.78 - 12.80		 3563.20.00	350 GMF350		
			 8505.40.00	KZI - 4,5		

Vehicle list



RENAULT TRUCKS

J					
JN 60, 75, 80 (5G.) JN 90 (5G.) JP 11, 13, 14 (5G.)	01.78 - 12.83 01.76 - 12.83 01.76 - 12.83		3100.90.01 3169.20.00 3113.30.00 6905.40.00	310 10 MF310 310GSBL KZIS - 3	- GBox: ZF S5-35
JK 60, 65, 75, 85 JK 75 Müllwagen JN 85 BOM (5G.) JN 85 Tankwagen (5G.)	- 04.86 - 04.86 06.79 - 01.78 - 12.83		2525.20.00	250 MF250	- Engine code: 720 - GBox: ZFS5-24
JK 60, 85	- 04.86		2525.20.00	250 MF250	- GBox: 321
			2520.30.00	250 10 250CB	- GBox: 321
JP 13 JR 19 JR 21	01.76 - 12.83 - 12.76 01.77 -		3500.90.42 3574.20.00 3587.30.00 8525.40.00	350 10 14" MF 350 350GSZ KZIS-3	- Engine code: 798 - GBox: ZF
JP 13 A (12G.) JR 19 JX 21	01.76 - 12.83 01.76 - 01.79 -		3574.20.00	350 14" MF 350	- Engine code: 797 - Engine code: 798 - GBox: ZFS6-65+GV80 - GBox: ZF

Vehicle list



RENAULT TRUCKS

K - Serie		01.13 -			
380P MEDIUM, 380P HEAVY 31KJ016HD000, 31KJ016MD000	01.13 -	DTI11-122HH DTI11-122HI	4300.90.129 ⊕ 4382.60.00 4398.30.00	430 24 MFZ430 430WGTZ	- Engine code: DTI 11 - Engine code: DTI 13 - GBox: MT 2214B / MT 2514B, MTO 2214B/MTO 2514B - GBox: MTO 2514B
380P MEDIUM, 380P HEAVY 31KK016MD000, 31KK016HD000	01.13 -	DTI13-122HK			
380P MEDIUM, 380P HEAVY 31KN016MD000, 31KN016HD000	01.13 -		8641.47.00	PHIS-6/38	- Engine code: DTI 11 - GBox: AT 2412/E /AT 2612/E, ATO 2612/E - GBox: AT2612/E / ATO2612/E
380P MEDIUM, 380P HEAVY 31KP016HD000, 31KP016MD000	01.13 -				
380P MEDIUM, 380P HEAVY, 380P XTREM 31KS016HD000, 31KS016MD000, 31KS016XT000	01.13 -				
380T MEDIUM, 380T HEAVY 31KA016MD000, 31KA016HD000	01.13 -				
380T MEDIUM, 380T HEAVY 31KE016MD000, 31KE016HD000	01.13 -				
380T MEDIUM, 380T HEAVY 31KF016MD000, 31KF016HD000	01.13 -				
430P MEDIUM, 430P HEAVY 31KJ016MD001, 31KJ016HD001	01.13 -				
430P MEDIUM, 430P HEAVY 31KK016MD001, 31KK016HD001	01.13 -				
430P MEDIUM, 430P HEAVY 31KN016HD001, 31KN016MD001	01.13 -				
430P MEDIUM, 430P HEAVY 31KP016MD001, 31KP016HD001	01.13 -				
430P MEDIUM, 430P HEAVY, 430P XTREM 31KS016XT001, 31KS016MD001, 31KS016HD001	01.13 -				
430T MEDIUM, 430T HEAVY 31KA016HD001, 31KA016MD001	01.13 -				
430T MEDIUM, 430T HEAVY 31KE016HD001, 31KE016MD001	01.13 -				
430T MEDIUM, 430T HEAVY 31KF016MD001, 31KF016HD001	01.13 -				
440P MEDIUM, 440P HEAVY 31KJ036MD000, 31KJ036HD000	01.13 -				
440P MEDIUM, 440P HEAVY 31KK036MD000, 31KK036HD000	01.13 -				
440P MEDIUM, 440P HEAVY 31KN036HD000, 31KN036MD000	01.13 -				
440P MEDIUM, 440P HEAVY 31KP036HD000, 31KP036MD000	01.13 -				
440P MEDIUM, 440P HEAVY, 440P XTREM 31KS036HD000, 31KS036XT000, 31KS036MD000	01.13 -				
440T MEDIUM, 440T HEAVY 31KA036MD000, 31KA036HD000	01.13 -				
440T MEDIUM, 440T HEAVY 31KE036MD000, 31KE036HD000	01.13 -				
440T MEDIUM, 440T HEAVY 31KF036MD000, 31KF036HD000	01.13 -				

Vehicle list

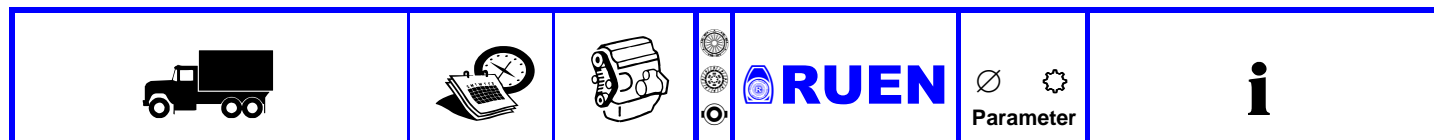

RENAULT TRUCKS

K - Serie		01.13 -			
460P MEDIUM, 460P HEAVY 31KJ016HD002, 31KJ016MD002	01.13 -	DTI11-122HJ	4300.90.129 ⊕ 4382.60.00 4398.30.00	430 24 MFZ430 430WGTZ	- Engine code: DTI 11 - Engine code: DTI 13
460P MEDIUM, 460P HEAVY 31KK016HD002, 31KK016MD002	01.13 -	DTI13-122HL DTI13-122HM			- GBox: MT 2214B / MT 2514B, MTO 2214B/MTO 2514B - GBox: MTO 2514B
460P MEDIUM, 460P HEAVY 31KN016HD002, 31KN016MD002	01.13 -		8641.47.00	PHIS-6/38	- Engine code: DTI 11 - Engine code: DTI 13
460P MEDIUM, 460P HEAVY 31KP016HD002, 31KP016MD002	01.13 -				- GBox: AT 2412/E / AT 2612/E, ATO 2612/E - GBox: AT2612/E / ATO2612/E
460P MEDIUM, 460P HEAVY, 480P XTREM 31KS016HD002, 31KS016MD002, 31KS016XT003	01.13 -				
460T MEDIUM, 460T HEAVY 31KA016HD002, 31KA016MD002	01.13 -				
460T MEDIUM, 460T HEAVY 31KE016MD002, 31KE016HD002	01.13 -				
460T MEDIUM, 460T HEAVY 31KF016HD002, 31KF016MD002	01.13 -				
480P MEDIUM, 480P HEAVY 31KJ036MD001, 31KJ036HD001	01.13 -				
480P MEDIUM, 480P HEAVY 31KK036HD001, 31KK036MD001	01.13 -				
480P MEDIUM, 480P HEAVY 31KN036HD001, 31KN036MD001	01.13 -				
480P MEDIUM, 480P HEAVY 31KP036HD001, 31KP036MD001	01.13 -				
480P MEDIUM, 480P HEAVY, 480P XTREM 31KS036HD001, 31KS036XT001, 31KS036MD001	01.13 -				
480T MEDIUM, 480T HEAVY 31KA036MD001, 31KA036HD001	01.13 -				
480T MEDIUM, 480T HEAVY 31KE036MD001, 31KE036HD001	01.13 -				
480T MEDIUM, 480T HEAVY 31KF036HD001, 31KF036MD001	01.13 -				
520P MEDIUM, 520P HEAVY 31KJ036MD002, 31KJ036HD002	01.13 -				
520P MEDIUM, 520P HEAVY, Platform/Chassis, 4x4	01.13 -				
520P MEDIUM, 520P HEAVY 31KN036MD002, 31KN036HD002	01.13 -				
520P MEDIUM, 520P HEAVY, Platform/Chassis, 6x6	01.13 -				
520P MEDIUM, 520P HEAVY, 520P XTREM 31KS036MD002, 31KS036XT003, 31KS036HD002	01.13 -				
520T MEDIUM, 520T HEAVY 31KA036HD002, 31KA036MD002	01.13 -				
520T MEDIUM, 520T HEAVY 31KE036HD002, 31KE036MD002	01.13 -				
520T MEDIUM, 520T HEAVY	01.13 -				

Vehicle list

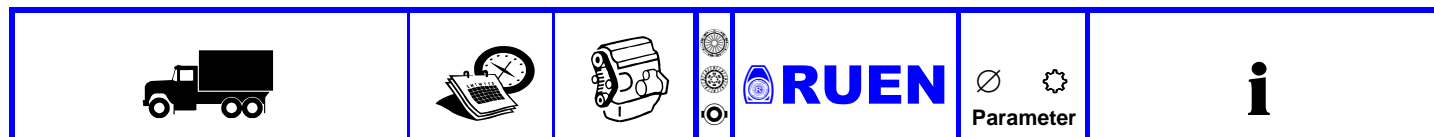

RENAULT TRUCKS

Kerax		06.97 -				
260.18 33BxB2	06.97 -	MIDR 06.20.45 C/4		4300.90.74	430 10	- Engine code: MIDR06.20.45C/41
260.18/B 33AXB2	06.97 -	MIDR 06.20.45 D/41		4311.20.00	MFZ430	- To model year: 12.1999
300.18/B 33AXB2	06.97 -			4312.30.00	430W2GTZ	- GBox: ZF 9S-109
300.26/A,300.26/B 33H02000004	06.97 -			8940.40.00	KZISZ-5	- GBox: ZF 8S-151
300.26/A,300.26/B 33DXB2, 33DXA2	06.97 -			4300.90.55	430 10	- Engine code: MIDR06.20.45D/41
300.26/B 33DXB2	06.97 -			4311.20.00	MFZ430	- To model year: 12.1999
				4346.30.00	430WGTZ	- GBox: ZF 16S-151
				8940.40.00	KZISZ-5	
				4300.90.60	430 10	- Engine code: MIDR06.20.45D/41
				4311.20.00	MFZ430	- From model year: 01.2000
				4312.30.00	430W2GTZ	- GBox: ZF 9S-109
				8937.40.00	KZISZ-5	- GBox: Eaton 8209A
				4300.90.39	430 10	- Engine code: MIDR06.20.45D/41
				4311.20.00	MFZ430	- From model year: 01.2000
				4313.30.00	430WGTZ	- GBox: ZF 16S-151
				8933.40.00	KZISZ - 5	
				4000.90.12	400 10	- Engine code: MIDR06.20.45D/41
				4026.10.00	MFZ2/400X	- GBox: ZF 16S-151, 8S-151
				4029.30.00	400GTZ	
				8941.40.00	KZISZ-5	
270.18 33PP	01.01 -	dCi 11-270		4300.90.60	430 10	- Engine code: dCi11-270
270.18 33RR	01.01 -			4311.20.00	MFZ430	- GBox: ZF 9S-109
				4312.30.00	430W2GTZ	- GBox: Eaton 8309/A
				8937.40.00	KZISZ-5	
				4000.90.12	400 10	- Engine code: dCi11-270
				4026.10.00	MFZ2/400X	
				4029.30.00	400GTZ	
				8941.40.00	KZISZ-5	
				43461.30.00	430 10	- GBox: ZF 16S-151
				430WGTZ		
				8995.40.00	KZIZ-6	- GBox: ZF 16S-151
320.18 33PP02100311	01.01 -	dCi 11G		4300.90.39	430 10	- Engine code: dCi11G
320.18 33RR02100311	01.01 -			4311.20.00	MFZ430	- GBox: ZF 8S-151, 16S-151
320.26 33HH02100318	01.01 -			4313.30.00	430WGTZ	
320.26 33HH02100312	01.01 -			8933.40.00	KZISZ - 5	
320.26 33II01100313, 33HH02100313	01.01 -			4000.90.12	400 10	- Engine code: dCi11G
				4026.10.00	MFZ2/400X	
				4029.30.00	400GTZ	
				8941.40.00	KZISZ-5	
				43461.30.00	430 10	- GBox: ZF 16S-151
				430WGTZ		
				8995.40.00	KZIZ-6	- GBox: ZF 16S-151

Vehicle list



RENAULT TRUCKS

Kerax		06.97 -			
340.18 33BxB2	06.97 -	MIDR 06.20.45 E/41	4300.90.61 <ul style="list-style-type: none"> 4311.20.00 4311.30.00 8937.40.00 	430 20 MFZ430 430W2GTZ KZISZ-5	- Engine code: MIDR06.20.45E/4 - GBox: B9
340.18/B 33AXB2	06.97 -		4300.90.40 <ul style="list-style-type: none"> 4311.20.00 4311.30.00 8932.40.00 	430 20 MFZ430 430W2GTZ KZISZ - 5	- Engine code: MIDR06.20.45E/4 - GBox: B9+35mm,B18
340.26/A,340.26/B	06.97 -		4000.90.07 <ul style="list-style-type: none"> 4026.10.00 4027.30.00 8937.40.00 	400 20 MFZ2/400X 400WGVZ KZISZ-5	- Engine code: MIDR06.20.45E/4 - GBox: B9+35mm,B18
340.26/A,340.26/B 33DXB2, 33DXA2	06.97 -		4300.90.55 <ul style="list-style-type: none"> 4311.20.00 4346.30.00 8940.40.00 	430 10 MFZ430 430WGTZ KZISZ-5	- Engine code: MIDR06.20.45E/4 - GBox: ZF 8S-151
340.26/B 33DXB2	06.97 -		4311.20.00	430 MFZ430	- Engine code: MIDR06.20.45E/4 - To model year: 05.2001 - GBox: ZF 16S-151
340.32/A	06.97 -		4327.30.00	430 10 430GTZ	- Engine code: MIDR06.20.45E/4 - To model year: 05.2001 - GBox: ZF 16S-151
340.32/A 33FXA1	06.97 -		8940.40.00	KZISZ-5	- To model year: 05.2001 - GBox: ZF 16S-151
			4300.90.41 <ul style="list-style-type: none"> 4311.20.00 4306.30.00 8933.40.00 	430 10 MFZ430 430WGTZ KZISZ - 5	- From model year: 05.2001 - GBox: ZF 16S-151
			4000.90.13 <ul style="list-style-type: none"> 4026.10.00 4029.30.00 8937.40.00 	400 10 MFZ2/400X 400GTZ KZISZ-5	- To model year: 12.1999 - GBox: ZF 16S-151
			4000.90.12 <ul style="list-style-type: none"> 4026.10.00 4029.30.00 8941.40.00 	400 10 MFZ2/400X 400GTZ KZISZ-5	- From model year: 01.2000 - GBox: ZF 8S-151 - GBox: ZF 16S-151 - GBox: ZF 16S-221
			4300.90.60 <ul style="list-style-type: none"> 4311.20.00 4312.30.00 8937.40.00 	430 10 MFZ430 430W2GTZ KZISZ-5	- GBox: Eaton 8209 A

Vehicle list



RENAULT TRUCKS

Kerax		06.97 -			
340.26 33M03000001	06.97 - 01.01	MIDR 06.20.45 E/41	4300.90.61 <ul style="list-style-type: none"> 4311.20.00 4311.30.00 8937.40.00 	430 20 MFZ430 430W2GTZ KZISZ-5	- GBox: B9
			4300.90.40 <ul style="list-style-type: none"> 4311.20.00 4311.30.00 8932.40.00 	430 20 MFZ430 430W2GTZ KZISZ - 5	- GBox: B9+35mm, B18
			4000.90.07 <ul style="list-style-type: none"> 4026.10.00 4027.30.00 8937.40.00 	400 20 MFZ2/400X 400WGVZ KZISZ-5	- GBox: B9+35mm, B18
			4300.90.55 <ul style="list-style-type: none"> 4311.20.00 4346.30.00 8940.40.00 	430 10 MFZ430 430WGTZ KZISZ-5	- GBox: ZF 8S-151
			4311.20.00	430 MFZ430	- GBox: ZF 16S-151
			4327.30.00	430 10 430GTZ	- GBox: ZF 16S-151
			8940.40.00	KZISZ-5	- GBox: ZF 16S-151
			4000.90.13 <ul style="list-style-type: none"> 4026.10.00 4029.30.00 8937.40.00 	400 10 MFZ2/400X 400GTZ KZISZ-5	- To model year: 12.1999 - GBox: ZF16S-151 - Vehicles with double disc clutch
			4000.90.12 <ul style="list-style-type: none"> 4026.10.00 4029.30.00 8941.40.00 	400 10 MFZ2/400X 400GTZ KZISZ-5	- From model year: 01.2000 - GBox: ZF 8S-151 - GBox: ZF 16S-151 - GBox: ZF 16S-221 - Vehicles with double disc clutch
			4300.90.60 <ul style="list-style-type: none"> 4311.20.00 4312.30.00 8937.40.00 	430 10 MFZ430 430W2GTZ KZISZ-5	- GBox: Eaton 8209 A
350.34 33A	01.03 -	MIDR 06.23.56 A/3	4300.90.39 <ul style="list-style-type: none"> 4311.20.00 4313.30.00 8933.40.00 	430 10 MFZ430 430WGTZ KZISZ - 5	- GBox: ZF 16S-151
			43461.30.00	430 10 430WGTZ	- GBox: ZF 16S-151
			8995.40.00	KZIZ-6	- GBox: ZF 16S-151
370 410		DXi 11	4300.90.91 <ul style="list-style-type: none"> 4311.20.00 4346.30.00 8933.40.00 	430 10 MFZ430 430WGTZ KZISZ - 5	- GBox: 16S1620TD/1820TO, 1920TD/2220TO/2220TD
			4329.30.00	430 24 430WGTZ.	- GBox: AT2412C/ATO2512C
			8641.47.00	PHIS-6/38	- GBox: AT2412C/ATO2512C
			4305.30.00	430 10 430W2GTZ	- GBox: 16S1620TD/1820TO - GBox: 1920TD/2220TO/2220TD
			8933.40.00	KZISZ - 5	- GBox: 16S1620TD/1820TO - GBox: 1920TD/2220TO/2220TD

Vehicle list



RENAULT TRUCKS

Kerax		06.97 -			
370.18 34SF01100423	01.01 -	dCi 11E	4300.90.60 4311.20.00 4312.30.00 8937.40.00	430 10 MFZ430 430W2GTZ KZISZ-5	- Vehicles with double disc clutch
370.18 33RR02100321	01.01 -				
370.18 33QQ02100321	01.01 -				
370.26 33HH02100328	01.01 -				
370.26 33HH02100312	01.01 -		4311.20.00	430 MFZ430	- GBox: ZF 8S-151 - GBox: ZF 16S-151 - GBox: ZF 16S-221
370.26 33GG03100321, 33HH02100323, 33II01100323	01.01 -				
370.26	01.01 -		8933.40.00	KZISZ - 5	- GBox: ZF 8S-151 - GBox: ZF 16S-151 - GBox: ZF 16S-221
370.26 33KK03100321	01.01 -				
370.32 33BB02100328	01.01 -				
370.32 33BB02100321	01.01 -		43461.30.00	430 10 430WGTZ	- GBox: ZF 16S-151
370.32 33CC01100323, 33AA03100321, 33BB02100323	01.01 -		8995.40.00	KZIZ-6	- GBox: ZF 16S-151
385.18	06.97 -	MIDR 06.23.56 AJ41	4300.90.61 ⁺ 4311.20.00 4311.30.00 8937.40.00	430 20 MFZ430 430W2GTZ KZISZ-5	- GBox: B9
385.18/B	06.97 -				
385.18T 33GVB2	06.97 -				
385.18T 33HVB2	06.97 -				
385.26 33EVC2	06.97 -		4300.90.40	430 20 MFZ430 430W2GTZ KZISZ - 5	- GBox: B+35mm,B18
385.26/A,385.26/B	06.97 -		4311.20.00 4311.30.00 8932.40.00		
385.26/A,385.26/B,385.26/C 33DVB2, 33DVC2, 33DVA2	06.97 -				
385.26/B 33DVB2	06.97 -		4000.90.07	400 20 MFZ2/400X 400WGVZ KZISZ-5	- GBox: B9+35mm,B18
385.26T 33KVC2	06.97 -		4026.10.00 4027.30.00 8937.40.00		
385.32/A,385.32/B	06.97 -				
385.32/A,385.32/B,385.32/C 33FVB1, 33FVC2, 33FVA1X	06.97 -		4300.90.55	430 10 MFZ430 430WGTZ KZISZ-5	- GBox: ZF 8S-151 - To model year: 05.2001 - GBox: ZF 16S-151 / 16E1
385.32/B 33FVB2	06.97 -		4311.20.00 4346.30.00 8940.40.00		
			4300.90.39	430 10 MFZ430 430WGTZ KZISZ - 5	- From model year: 05.2001 - GBox: ZF 16S-151 / 17E1
			4311.20.00 4313.30.00 8933.40.00		
			4000.90.13	400 10 MFZ2/400X 400GTZ KZISZ-5	- To model year: 12.1999 - GBox: ZF 16S-151 - Vehicles with double disc clutch
			4026.10.00 4029.30.00 8937.40.00		
			4000.90.12	400 10 MFZ2/400X 400GTZ KZISZ-5	- From model year: 01.2000 - GBox: ZF 8S-151 - GBox: ZF 16S-151 - GBox: ZF 16S-221 - Vehicles with double disc clutch
			4026.10.00 4029.30.00 8941.40.00		
			4300.90.60	430 10 MFZ430 430W2GTZ KZISZ-5	- GBox: Eaton 8209 A
			4311.20.00 4312.30.00 8937.40.00		
			43461.30.00	430 10 430WGTZ	- GBox: ZF 16S-151
			8995.40.00	KZIZ-6	- GBox: ZF 16S-151

Vehicle list



RENAULT TRUCKS

Kerax		06.97 -			
400.18	01.00 -	MIDR 06.23.56 B/41	4300.90.60 4311.20.00 4312.30.00 8937.40.00	430 10 MFZ430 430W2GTZ KZISZ-5	- GBox: Eaton 8209 A
400.18T, Truck Tractor, 4x2	01.00 -		4300.90.55 4311.20.00 4346.30.00 8940.40.00	430 10 MFZ430 430WGTZ KZISZ-5	- GBox: ZF8S-151 - To model year: 05.2001 - GBox: ZF 16S-151 / CAM16E1
400.18T, Truck Tractor, 4x4	01.00 -		4300.90.39 4311.20.00 4313.30.00 8933.40.00	430 10 MFZ430 430WGTZ KZISZ - 5	- From model year: 05.2001 - GBox: ZF 16S-151 / CAM17E1
400.26	09.98 -		4000.90.12 4026.10.00 4029.30.00 8941.40.00	400 10 MFZ2/400X 400GTZ KZISZ-5	- GBox: ZF 8S-151 - GBox: ZF 16S-151/221/251 - Vehicles with double disc clutch
400.26/A,400.26/B,400.26/C	01.00 -		43461.30.00 8995.40.00	430 10 430WGTZ	- GBox: ZF 16S-151
400.26/B, Concrete Mixer, 6x4	01.00 -		4300.90.39 4311.20.00 4313.30.00 8933.40.00	430 10 MFZ430 430WGTZ KZISZ - 5	- GBox: ZF 16S-151
400.26/B, Dump Truck, 6x4	01.00 -		4000.90.12 4026.10.00 4029.30.00 8941.40.00	400 10 MFZ2/400X 400GTZ KZISZ-5	- GBox: ZF 16S-151
400.26T	01.00 -		43461.30.00 8995.40.00	430 10 430WGTZ	- GBox: ZF 16S-151
400.32/A,400.32/B,400.32/C	01.00 -		4300.90.39 4311.20.00 4313.30.00 8933.40.00	430 10 MFZ430 430WGTZ KZISZ - 5	- From model year: 05.2001 - GBox: ZF 16S-151 / CAM17E1
400.32/B, Concrete Mixer, 8x8/4	01.00 -		4000.90.12 4026.10.00 4029.30.00 8941.40.00	400 10 MFZ2/400X 400GTZ KZISZ-5	- GBox: ZF 8S-151 - GBox: ZF 16S-151/221/251 - Vehicles with double disc clutch
400.32/B, Dump Truck, 8x4/4	01.00 -	43461.30.00 8995.40.00	430 10 430WGTZ	- GBox: ZF 16S-151	
420.18 33PP02100331	01.01 -	dCi 11C	4300.90.39 4311.20.00 4313.30.00 8933.40.00	430 10 MFZ430 430WGTZ KZISZ - 5	- GBox: ZF 8S-151 - GBox: ZF 16S-151 - GBox: ZF 16S-221
420.18 33RR02100331	01.01 -		4300.90.54 4311.20.00 4346.30.00 8937.40.00	430 10 MFZ430 430WGTZ KZISZ-5	- GBox: Eaton 8309/A
420.18 33QQ02100331, 33PP02100331	01.01 -		4000.90.12 4026.10.00 4029.30.00 8941.40.00	400 10 MFZ2/400X 400GTZ KZISZ-5	- Vehicles with double disc clutch
420.18 33SS02100331	01.01 -		43461.30.00 8995.40.00	430 10 430WGTZ	- GBox: ZF 16S-151
420.26 33HH02100338	01.01 -		4300.90.39 4311.20.00 4313.30.00 8933.40.00	430 10 MFZ430 430WGTZ KZISZ - 5	- GBox: ZF 16S-151
420.26 33BB02100338	01.01 -		4000.90.12 4026.10.00 4029.30.00 8941.40.00	400 10 MFZ2/400X 400GTZ KZISZ-5	- GBox: ZF 16S-151
420.26 33HH02100332, 33HH02100331	01.01 -		43461.30.00 8995.40.00	430 10 430WGTZ	- GBox: ZF 16S-151
420.26 33BB02100331	01.01 -		4000.90.12 4026.10.00 4029.30.00 8941.40.00	400 10 MFZ2/400X 400GTZ KZISZ-5	- GBox: ZF 16S-151
420.26 33GG03100331, 33II01100333, 33HH02100333	01.01 -		43461.30.00 8995.40.00	430 10 430WGTZ	- GBox: ZF 16S-151
420.26 33AA03100331, 33CC01100333, 33BB02100333	01.01 -		4300.90.39 4311.20.00 4313.30.00 8933.40.00	430 10 MFZ430 430WGTZ KZISZ - 5	- GBox: ZF 16S-151
420.26 33KK03100331	01.01 -	4000.90.12 4026.10.00 4029.30.00 8941.40.00	400 10 MFZ2/400X 400GTZ KZISZ-5	- GBox: ZF 16S-151	
420.32 33BB02100338	10.01 -	43461.30.00 8995.40.00	430 10 430WGTZ	- GBox: ZF 16S-151	
420.32 33BB02100331	10.01 -	4300.90.39 4311.20.00 4313.30.00 8933.40.00	430 10 MFZ430 430WGTZ KZISZ - 5	- GBox: ZF 16S-151	
420.32 33AA03100331, 33CC01100333, 33BB02100333	10.01 -	4000.90.12 4026.10.00 4029.30.00 8941.40.00	400 10 MFZ2/400X 400GTZ KZISZ-5	- GBox: ZF 16S-151	
420.34 33MM03100331	01.01 -	43461.30.00 8995.40.00	430 10 430WGTZ	- GBox: ZF 16S-151	
450		DXi 11	4300.90.91 4311.20.00 4346.30.00 8933.40.00	430 10 MFZ430 430WGTZ KZISZ - 5	- GBox: 16S1620TD/1820TO, 1920TD/2220TO/2220TD
			4398.30.00 8641.47.00	430 24 430WGTZ	- GBox: AT2412C/ATO2512C
			4305.30.00 8933.40.00	430 10 430W2GTZ	- GBox: 16S20TD/1820TO - GBox: 1920TD/2220TO/2220TD
			8933.40.00	KZISZ - 5	- GBox: 16S1620TD/1820TO - GBox: 1920TD/2220TO/2220TD
			4305.30.00 8933.40.00	430 10 430W2GTZ	- GBox: 16S20TD/1820TO - GBox: 1920TD/2220TO/2220TD

Vehicle list

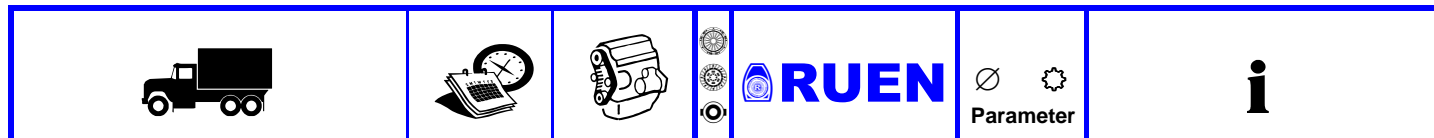

RENAULT TRUCKS

Kerax

06.97 -

Part Number	Year	Engine	Price	Engine Code	Clutch	Notes	
370.18 34SF01100423	10.05 -	DXi 11	4300.90.91	430 10 MFZ430	- Engine code: DXi11 - GBox: ZF		
370.18 34XF01100423	10.05 -		4311.20.00				
370.18 34TF01100423	10.05 -		4346.30.00				
370.18 34YF01100423	10.05 -		8933.40.00				
370.26 34NF01100428	10.05 -		4026.10.00	400 MFZ2/400X	- Engine code: DXi11 - Vehicles with double disc clutch - This part number includes one clutch disc		
370.26 34NF01100425	10.05 -						
370.26 34NF01100423, 34NF01100523	10.05 -		4028.30.00	400 6 400GTZ	- Engine code: DXi11 - Vehicles with double disc clutch		
370.26 34MF01100523, 34MF01100423	10.05 -						
370.26 34FF01100423, 34FF01100523	10.05 -		4029.30.00	400 10 400GTZ	- Engine code: DXi11 - Vehicles with double disc clutch		
370.26 34ZF01100523	10.05 -						
370.32 34LF01100428	10.05 -		8941.40.00	KZISZ-5	- Engine code: DXi11 - Vehicles with double disc clutch		
370.32 34LF01100425	10.05 -						
370.32 34LF01100523, 34LF01100423	10.05 -		4329.30.00	430 24 430WGTZ.	- Engine code: DXi11 - GBox: AT2412C/ATO2512C		
410.18 34SF01100443	10.05 -						
410.18 34XF01100443	10.05 -		8641.47.00	PHIS-6/38	- Engine code: DXi11 - GBox: AT2412C/ATO2512C		
410.18 34TF01100443	10.05 -						
410.18 34YF01100443	10.05 -	8933.40.00	KZISZ - 5	- Engine code: DXi11 - GBox: ZF			
410.26 34NF01100448	10.05 -						
410.26 34NF01100445	10.05 -						
410.26 34NF01100543, 34NF01100443	10.05 -						
410.26 34MF01100443, 34MF01100543	10.05 -						
410.26 34FF01100543, 34FF01100443	10.05 -						
410.26 34ZF01100543	10.05 -						
410.32 34LF01100448	10.05 -						
410.32 34LF01100445	10.05 -						
410.32 34LF01100543, 34LF01100443	10.05 -						
450.18 34SF01100463	10.05 -	DXi 11			4300.90.91	430 10 MFZ430	- Engine code: DXi11 - GBox: ZF
450.18 34XF01100463	10.05 -				4311.20.00		
450.18 34TF01100463	10.05 -		4346.30.00				
450.18 34YF01100463	10.05 -		8933.40.00				
450.26 34NF01100468	10.05 -		4026.10.00	400 MFZ2/400X	- Engine code: DXi11 - Vehicles with double disc clutch - This part number includes one clutch disc		
450.26 34NF01100465	10.05 -						
450.26 34NF01100563, 34NF01100463	10.05 -		4028.30.00	400 6 400GTZ	- Engine code: DXi11 - Vehicles with double disc clutch		
450.26 34MF01100563, 34MF01100463	10.05 -						
450.26 34FF01100563, 34FF01100463	10.05 -		4029.30.00	400 10 400GTZ	- Engine code: DXi11 - Vehicles with double disc clutch		
450.26 34ZF01100563	10.05 -						
450.32 34LF01100468	10.05 -		8941.40.00	KZISZ-5	- Engine code: DXi11 - Vehicles with double disc clutch		
450.32 34LF01100465	10.05 -						
450.32 34LF01100463, 34LF01100563	10.05 -		4398.30.00	430 24 430WGTZ	- Engine code: DXi11 - GBox: AT2412C/ATO2512C		
			8641.47.00	PHIS-6/38	- Engine code: DXi11 - GBox: AT2412C/ATO2512C		
		8933.40.00	KZISZ - 5	- Engine code: DXi11 - GBox: ZF			

Vehicle list



RENAULT TRUCKS

Kerax		06.97 -				
460.32 36LE01300478	05.06 -	DXi 13		4398.30.00	430 24 430WGTZ	- Engine code: DXi 13 - GBox: AT2412C/AT2512C, ATO2512C
460.32 36LE01300475	05.06 -			8641.47.00	PHIS-6/38	- Engine code: DXi 13 - GBox: AT2412C/AT2512C, ATO2512C
460.32 36LE01300573, 36LE01300473	05.06 -			4300.90.117	430 10 MFZ430	- Engine code: DXi 13 - GBox: ZF 16S-2520 TO, ZF 16S-2320 TD
500.32 36LE01300488	05.06 -			4395.20.00	430WGTZ	- Vehicles with single clutch disc
500.32 36LE01300485	05.06 -			4399.30.00	KZISZ - 5	
500.32 36LE01300483, 36LE01300583	05.06 -			4000.90.12	400 10 MFZ2/400X	- Engine code: DXi 13 - GBox: ZF 16S-2520 TO, ZF 16S-2320 TD
				4026.10.00	400GTZ	- Vehicles with double disc clutch
				8941.40.00	KZISZ-5	- This part number includes one clutch disc
				4029.30.00	400 10 400GTZ	- Engine code: DXi 13 - GBox: ZF 16S-2520 TO, ZF 16S-2320 TD
				4028.30.00	400 6 400GTZ	- Engine code: DXi 13 - GBox: ZF 16S-2520 TO, ZF 16S-2320 TD
			8941.40.00	KZISZ-5	- Engine code: DXi 13 - GBox: ZF 16S-2520 TO, ZF 16S-2320 TD	
			8933.40.00	KZISZ - 5	- Engine code: DXi 13 - GBox: ZF 16S-2520 TO, ZF 16S-2320 TD	
					- Vehicles with single clutch disc	
Magnum		09.90 -				
E.TECH 400.18 11F00400451, 11F00400401, 11F00400001, 11F00400051	05.00 -	MACK E.TECH A/46 MACK E.TECH C/46		4300.90.39	430 10 MFZ430	- To model year: 03/2003
E.TECH 400.18T 11E00400021, 11E00400401, 11E00400001, 11E00400451, 11E00400411	05.00 -			4311.20.00	430WGTZ	
E.TECH 400.24 11F01300051	05.00 -			4313.30.00	KZISZ - 5	
E.TECH 400.26 11F01300451, 11F01300001, 11F01300011, 11F01300031, 11F01300461	05.00 -			8933.40.00	KZISZ - 5	
E.TECH 400.26 11F01300451, 11F01300001, 11F01300011, 11F01300031, 11F01300461	05.00 -			4300.90.17	430 10 MFZ430	- From model year: 03/2003
E.TECH 480.18 11F00400453, 11F00400003, 11F00400403	05.00 -			4311.20.00	430WGTZ	
E.TECH 480.18T 11E00400403, 11E00400413, 11E00400013, 11E00400453, 11E00400003, 11E00400023	05.00 -			4346.30.00	KZISZ - 5	
E.TECH 480.18T 11E00400403, 11E00400413, 11E00400013, 11E00400453, 11E00400003, 11E00400023	05.00 -			8919.40.00	KZISZ - 5	
E.TECH 480.24 11F01300053, 11F01300453	05.00 -			4000.90.12	400 10 MFZ2/400X	- Vehicles with double disc clutch
E.TECH 480.26 11F01300063, 11F01300413, 11F01300433, 11F01300013, 11F01300403, 11F01300003, 11F01300453	05.00 -			4026.10.00	400GTZ	
E.TECH 480.26T 11E01300433, 11E01300013	05.00 -		4029.30.00	KZISZ-5		
			8941.40.00	KZISZ-5		
AE 380. 18 T (11GZA3)	03.90 - 09.92	MIDR 06.35.40 H		4311.30.00	430 20 430W2GTZ	
AE 380. 19 (11AZA1)	03.90 - 09.92	MIDR 06.35.40 N/3		8936.40.00	KZISZ - 5	
AE 380. 26 6x2 (11CZA1)	03.90 - 09.92					
AE 380. TI (11GZA1)	03.90 - 09.92					
AE 420. TI	- 09.92					

Vehicle list

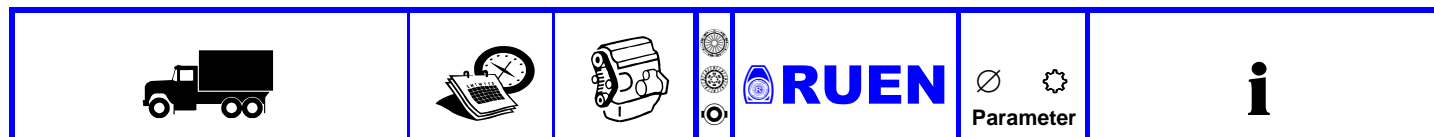

RENAULT TRUCKS

Magnum		09.90 -				
E.TECH 440.18 11F00400402, 11F00400452, 11F00400052, 11F00400002	05.00 -	MACK E.TECH B/46	4300.90.17 4311.20.00 4346.30.00 8919.40.00	430 10 MFZ430 430WGTZ KZISZ - 5		
E.TECH 440.18T 11E00400452, 11E00400412, 11E00400002, 11E00400012, 11E00400022, 11E00400402	05.00 -		4000.90.12 4026.10.00 4029.30.00 8941.40.00	400 10 MFZ2/400X 400GTZ KZISZ-5	- Vehicles with double disc clutch	
E.TECH 440.24 11F01300052	05.00 -					
E.TECH 440.26 11F01300002, 11F01300402, 11F01300012, 11F01300062, 11F01300432, 11F01300412	05.00 -					
E.TECH 440.26T 11E01300462, 11E01300012, 11E01300432	05.00 -					
AE 385. TI	- 09.92		4311.30.00 8936.40.00 4343.30.00	430 20 430W2GTZ 430 10 430GTZ	- Engine code: MIDR063540L1 - GBox: B9/B18 - Engine code: MIDR063540L1 - GBox: B9/B18; Fuller - Engine code: MIDR063540L1 - GBox: Fuller	
AE 385ti.18	02.92 - 10.96	MIDR 06.35.40 N/3	4300.90.99 4311.26.00 4311.30.00 8938.46.00	430 20 MFZ430 430W2GTZ	- GBox: B18, B9+35mm	
AE 385ti.18T 11GZA1	02.92 - 10.96					
AE 385ti.26 11CZA1	02.92 - 10.96		4300.90.349 4311.26.00 4311.30.00 8936.46.00	430 20 MFZ430 430W2GTZ KZISZ-5	- GBox: B9	
			4300.90.46 ⁺ 4335.60.00 4327.30.00	430 10 MFZ430 430GTZ	- GBox: Fuller	
E.TECH 440.26T 11H00400002, 11H00400402	05.00 -	MACK E.TECH B/46	4000.90.12 4026.10.00 4029.30.00 8941.40.00	400 10 MFZ2/400X 400GTZ KZISZ-5	- Vehicles with double disc clutch	
E.TECH 480.26T 11H00400403, 11H00400003	05.00 -	MACK E.TECH C/46				
AE 390.18 11ATA1	09.96 -	MIDR 06.24.65 A/42	4300.90.61 ⁺ 4311.20.00 4311.30.00 8937.40.00	430 20 MFZ430 430W2GTZ KZISZ-5	- GBox: B9	
AE 390.18T 11GTA1	09.96 -					
AE 390.26 11CTA1	09.96 -		4300.90.40 4311.20.00 4311.30.00 8932.40.00	430 20 MFZ430 430W2GTZ KZISZ - 5	- GBox: B9+35mm,B18	
			4000.90.07 4026.10.00 4027.30.00 8937.40.00	400 20 MFZ2/400X 400WGVZ KZISZ-5	- Engine code: B9+35mm,B18 - Vehicles with double disc clutch	
			4000.90.12 4026.10.00 4029.30.00 8941.40.00	400 10 MFZ2/400X 400GTZ KZISZ-5	- GBox: ZF 16S 221 - From model year: 03/1999	

Vehicle list

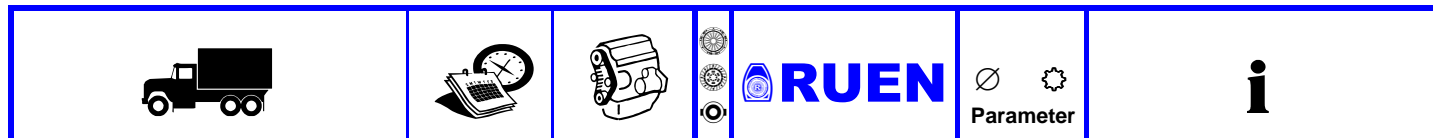







RENAULT TRUCKS

Magnum























09.90 -

AE 420ti.18 11AZA1 AE 420ti.18T 11GZA1 AE 420ti.24T 11JZA1 AE 420ti.26 11CZA1 AE 420ti.26T 11KZC1	10.92 - 12.96 10.92 - 12.96 10.92 - 12.96 10.92 - 12.96 10.92 - 12.96	MIDR 06.35.40 J/3 MIDR 06.35.40 P/41	4300.90.99 4311.26.00 4311.30.00 8938.46.00	430 20 MFZ430 430W2GTZ	- GBox: B9+35mm,B18 - To model year: 08/1996
			4000.90.19 ⊕ 4036.10.00 4027.30.00	400 20 MFZ2/400X 400WGVZ	- GBox: B9+35mm,B18 - To model year: 08/1996
			4300.90.40 4311.20.00 4311.30.00 8932.40.00	430 20 MFZ430 430W2GTZ KZISZ - 5	- GBox: B9+35mm,B18 - From model year: 09/1996
			4000.90.07 4026.10.00 4027.30.00 8937.40.00	400 20 MFZ2/400X 400WGVZ KZISZ-5	- GBox: B9+35mm,B18 - From model year: 09/1996
AE 430.18 11ATA1 AE 430.18T 11GTA1 AE 430.26 11CTA1 AE 430.26T 11KZC1 AE 470.18 11ATA1 AE 470.18T 11GTA1 AE 470.26 11CTA1	09.96 - 09.96 - 09.96 - 01.97 - 11.96 - 11.96 - 01.97 -	MIDR 06.24.65 B/42 MIDR 06.24.65 C/42	4300.90.61 ⊕ 4311.20.00 4311.30.00 8937.40.00	430 20 MFZ430 430W2GTZ KZISZ-5	- GBox: B9
			4300.90.40 4311.20.00 4311.30.00 8932.40.00	430 20 MFZ430 430W2GTZ KZISZ - 5	- GBox: B9+35mm,B18
			4000.90.07 4026.10.00 4027.30.00 8937.40.00	400 20 MFZ2/400X 400WGVZ KZISZ-5	- GBox: B9+35mm,B18
			4300.90.38 4311.20.00 4326.30.00 8932.40.00	430 10 MFZ430 430WGTZ KZISZ - 5	- GBox: ZF 16S 221 - From model year: 11/1997
			4000.90.13 4026.10.00 4029.30.00 8937.40.00	400 10 MFZ2/400X 400GTZ KZISZ-5	- GBox: ZF 16S 221 - From model year: 11/1997
AE 430.26T 11JTA1 AE 470.26T 11KZC1	01.98 - 01.98 -	MIDR 06.24.65 B/42 MIDR 06.24.65 C/42	4300.90.61 ⊕ 4311.20.00 4311.30.00 8937.40.00	430 20 MFZ430 430W2GTZ KZISZ-5	- GBox: B9
			4300.90.40 4311.20.00 4311.30.00 8932.40.00	430 20 MFZ430 430W2GTZ KZISZ - 5	- GBox: B9+35mm,B18
			4000.90.07 4026.10.00 4027.30.00 8937.40.00	400 20 MFZ2/400X 400WGVZ KZISZ-5	- GBox: B9+35mm,B18
			4300.90.38 4311.20.00 4326.30.00 8932.40.00	430 10 MFZ430 430WGTZ KZISZ - 5	- GBox: ZF 16S 221
			4000.90.13 4026.10.00 4029.30.00 8937.40.00	400 10 MFZ2/400X 400GTZ KZISZ-5	- GBox: ZF 16S 221







Vehicle list

					
---	---	---	--	---	---

































RENAULT TRUCKS

Magnum		09.90 -			
AE 440		DXI 12	 4300.90.62 ⊕  4336.60.00  4329.30.00	430 24 MFZ430 430WGTZ.	- GBox: VT2412B
			 4029.30.00	400 10 400GTZ	- GBox: 16S 221DD - GBox: 16S 122 - GBox: 16S 181 - Vehicles with double disc clutch
			 8941.40.00	KZISZ-5	- GBox: 16S 221DD - GBox: 16S 122 - GBox: 16S 181 - Vehicles with double disc clutch
			 4305.30.00	430 10 430W2GTZ	- GBox: 16S 221DD - GBox: 16S 122 - GBox: 16S 181
			 8933.40.00	KZISZ - 5	- GBox: 16S 221DD - GBox: 16S 122 - GBox: 16S 181
			 4026.10.00	400 MFZ2/400X	- GBox: 16S 221DD, 16S 122, 16S 181 - Vehicles with double disc clutch
			 4026.50.00	400 MFZ2/400X	- GBox: 16S 221DD, 16S 122, 16S 181 - Vehicles with double disc clutch
AE 480		DXI 12	 4300.90.63 ⊕  4385.60.00  4389.30.00	430 24 MFZ430 430WGTZ	- GBox: VT2412B
			 4029.30.00	400 10 400GTZ	- GBox: 16S 221DD - GBox: 16S 122 - GBox: 16S 181 - Vehicles with double disc clutch
			 8941.40.00	KZISZ-5	- GBox: 16S 221DD - GBox: 16S 122 - GBox: 16S 181 - Vehicles with double disc clutch
			 8933.40.00	KZISZ - 5	- GBox: 16S 221DD - GBox: 16S 122 - GBox: 16S 181
			 4026.10.00	400 MFZ2/400X	- Vehicles with double disc clutch - GBox: 16S 221DD, 16S 122, 16S 181 - This part number includes one clutch disc
			 4026.50.00	400 MFZ2/400X	- GBox: 16S 221DD, 16S 122, 16S 181 - Vehicles with double disc clutch
AE 500. 18 T (11GWA3) AE 500. 19 (11AWA1) AE 500. 19 T (11GWA1) AE 500. 22 T (11GWA1) AE 500. 26 6x2 (11CWA1)	01.90 - 04.92 01.90 - 04.92 01.90 - 04.92 01.90 - 04.92 01.90 - 04.92		 4311.30.00	430 20 430W2GTZ	- GBox: B18
			 8936.40.00	KZISZ - 5	- GBox: B18
AE 520.18 11AWA1 AE 520.18T 11GWA1 AE 520.24T 11JWA1 AE 520.26T 11KWC1	10.92 - 05.96 10.92 - 05.96 10.92 - 05.96 10.92 - 05.96	Mack-EE9-530	 4000.90.07  4026.10.00  4027.30.00  8937.40.00	400 20 MFZ2/400X 400WGVZ KZISZ-5	- GBox: B9+35mm,B18 - From model year: 04/1995

Vehicle list

					
---	---	---	--	---	---

RENAULT TRUCKS

Magnum		09.90 -			
DXi 12 440.18	10.04 - 04.06	DXi 12	 4300.90.62 ⊕  4336.60.00  4329.30.00	430 24 MFZ430 430WGTZ.	- GBox: VT2412B
DXi 12 440.18 T	10.04 - 04.06				
DXi 12 440.24	10.04 - 04.06				
DXi 12 440.26	10.04 - 04.06		 4029.30.00	400 10 400GTZ	- GBox: 16S-2220 / 16S-221DD - GBox: 16S-122 / 16S-181 - Vehicles with double disc clutch
DXi 12 440.26 T, Truck Tractor, 6x2	10.04 - 04.06				
DXi 12 440.26 T, Truck Tractor, 6x4	10.04 - 04.06		 8941.40.00	KZISZ-5	- GBox: 16S-2220 / 16S-221DD - GBox: 16S-122 / 16S-181 - Vehicles with double disc clutch
			 4305.30.00	430 10 430W2GTZ	- GBox: 16S-221DD / 16S-122 - GBox: 16S-181 - GBox: 16S-220
			 8933.40.00	KZISZ - 5	- GBox: 16S-221DD / 16S-122 - GBox: 16S-181 - GBox: 16S-220
			 4026.10.00	400 MFZ2/400X	- Engine code: DXi 12 - GBox: 16S-2220 / 16S-221DD, 16S-122 / 16S-181 - Vehicles with double disc clutch - This part number includes one clutch disc
			 4300.90.91  4311.20.00  4346.30.00  8933.40.00	430 10 MFZ430 430WGTZ KZISZ - 5	- Engine code: DXi 12 - GBox: 16S-221DD / 16S-122, 16S-181 / 16S-222, 16S-220
DXi 12 480.18	10.04 - 04.06	DXi 12	 4300.90.63 ⊕  4385.60.00  4389.30.00	430 24 MFZ430 430WGTZ	- GBox: VT2412B
DXi 12 480.18 T	10.04 - 04.06				
DXi 12 480.24	10.04 - 04.06				
DXi 12 480.26	10.04 - 04.06		 4029.30.00	400 10 400GTZ	- GBox: 16S-2220 / 16S-221DD - GBox: 16S-122 / 16S-181 - Vehicles with double disc clutch
DXi 12 480.26 T, Truck Tractor, 6x2	10.04 - 04.06				
DXi 12 480.26 T, Truck Tractor, 6x4	10.04 - 04.06		 8941.40.00	KZISZ-5	- GBox: 16S-2220 / 16S-221DD - GBox: 16S-122 / 16S-181 - Vehicles with double disc clutch
			 4305.20.00	430 MFZ430	- GBox: 16S-2220
			 8933.40.00	KZISZ - 5	- GBox: 16S-2220 - GBox: 16S-222 - GBox: 16S-221DD / 16S-122 - GBox: 16S-181
			 4306.30.00	430 10 430WGTZ	- GBox: 16S-222
			 4026.10.00	400 MFZ2/400X	- Engine code: DXi 12 - GBox: 16S-2220 / 16S-221DD, 16S-122 / 16S-181 - Vehicles with double disc clutch - This part number includes one clutch disc
			 4300.90.91  4311.20.00  4346.30.00  8933.40.00	430 10 MFZ430 430WGTZ KZISZ - 5	- Engine code: DXi 12 - GBox: 16S-2220
			 4300.90.119  4390.20.00  4399.30.00  8933.40.00	430 10 MFZ430 430WGTZ KZISZ - 5	- Engine code: DXi 12 - GBox: 16S-222
AE 520.26 11CWA1	10.92 -	Mack-EE9-530	 4000.90.07  4026.10.00  4027.30.00  8937.40.00	400 20 MFZ2/400X 400WGVZ KZISZ-5	- GBox: B9+35mm,B18 - From model year: 04/1995 - To model year: 05/1996 - Vehicles with double disc clutch

Vehicle list

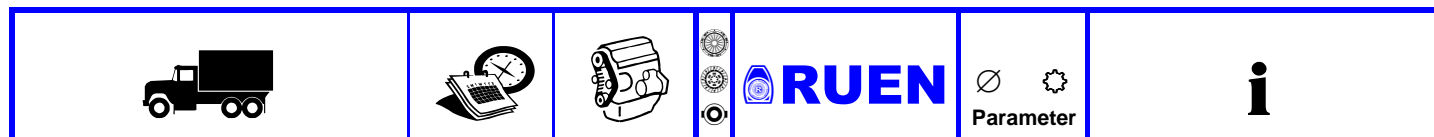

RENAULT TRUCKS

Magnum		09.90 -			
AE 560.18 11AWA1	04.96 -	Mack-EE9-560	4000.90.20 4029.10.00 4037.30.00 8937.40.00	400 20 MFZ2/400X 400WGTZ KZISZ-5	- GBox: B9+35mm,18 - Vehicles with double disc clutch
AE 560.18T 11GWA1	04.96 -				
AE 560.26 11CWA1	04.96 -				
AE 560.26T 11KWC1	01.97 -				
AE 560.26T 11JTA1	01.98 -				
DXi 13 460.18 T 17TE00100033, 17TE00100013, 17TE00100053, 17TE00100003	05.06 -	DXi 13	4398.30.00	430 24 430WGTZ	- Engine code: DXi 13 - GBox: AT2412C/AT2512C, ATO2512C
DXi 13 460.24 17RE00100053	05.06 -		8641.47.00	PHIS-6/38	- Engine code: DXi 13 - GBox: AT2412C/AT2512C, ATO2512C
DXi 13 460.25 17RE00100063	05.06 -		4300.90.117	430 10 MFZ430	- Engine code: DXi 13
DXi 13 460.26 17RE00100003	05.06 -		4395.20.00 4399.30.00	430WGTZ	- GBox: ZF 16S-2520 TO, ZF 16S-2320 TD
DXi 13 460.26 T 17JE00100003	05.06 -		8933.40.00	KZISZ - 5	
DXi 13 500.18 T 17TE00100015, 17TE00100035, 17TE00100005, 17TE00100055	05.06 -		4000.90.12	400 10 MFZ2/400X	- Engine code: DXi 13
DXi 13 500.24 17RE00100055	05.06 -		4026.10.00 4029.30.00	400GTZ	- GBox: ZF 16S-2520 TO, ZF 16S-2320 TD
DXi 13 500.25 17RE00100065	05.06 -		8941.40.00	KZISZ-5	- Vehicles with double disc clutch
DXi 13 500.26 17RE00100005	05.06 -				
DXi 13 500.26 T 17JE00100005	05.06 -				
AE 380.18	09.90 - 06.92	MIDR 06.35.40	4311.30.00	430 20 430W2GTZ	- GBox: B9/B18
AE 380.18T	09.90 - 06.92	H			
AE 380.26	09.90 - 06.92		8936.40.00	KZISZ - 5	- GBox: B9/B18
AE 380.26T, Truck Tractor, 6x2	09.90 - 06.92				
AE 380.26T, Truck Tractor, 6x4	09.90 - 06.92				
AE 385ti.19 11AZA1	02.92 - 10.96	MIDR 06.35.40	4300.90.99	430 20 MFZ430	- GBox: B18, B9+35mm
AE 385ti.19T 11GZA1	02.92 - 10.96	N/3	4311.26.00 4311.30.00	430W2GTZ	
AE 385ti.24	02.92 - 10.96		8938.46.00		
			4300.90.349	430 20 MFZ430	- GBox: B9
			4311.26.00 4311.30.00	430W2GTZ	
			8936.46.00	KZISZ-5	
			4300.90.46 ⊕	430 10 MFZ430	- GBox: Fuller
			4335.60.00 4327.30.00	430GTZ	
AE 390.19 11ATA1	09.96 -	MIDR 06.24.65	4300.90.61 ⊕	430 20 MFZ430	- Engine code: MIDR062465A/42
AE 390.19T 11GTA1	09.96 -	A/42	4311.20.00 4311.30.00	430W2GTZ	- GBox: B9
			8937.40.00	KZISZ-5	
			4300.90.40	430 20 MFZ430	- Engine code: MIDR062465A/42
			4311.20.00 4311.30.00	430W2GTZ	- GBox: B9+35mm,B18
			8932.40.00	KZISZ - 5	
			4000.90.07	400 20 MFZ2/400X	- Engine code: MIDR062465A/42
			4026.10.00 4027.30.00	400WGVZ	- GBox: B9+35mm,B18
			8937.40.00	KZISZ-5	
			4000.90.12	400 10 MFZ2/400X	- Engine code: MIDR062465A/42
			4026.10.00 4029.30.00	400GTZ	- GBox: ZF 16S 221
			8941.40.00	KZISZ-5	- From model year: 03/1999

Vehicle list

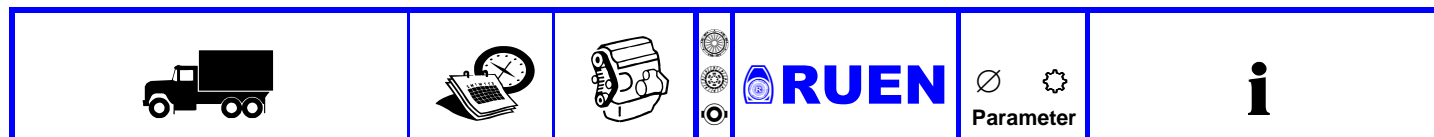

RENAULT TRUCKS

Magnum		09.90 -			
AE 420ti.19 AE 420ti.19T 11GZA1 AE 420ti.22T 11KZA1 AE 420ti.24 11CZA3	10.92 - 12.96 10.92 - 12.96 10.92 - 10.96 10.92 - 12.96	MIDR 06.35.40 J/3 MIDR 06.35.40 P/41	4300.90.99 4311.26.00 4311.30.00 8938.46.00 4000.90.19 ⊕ 4036.10.00 4027.30.00 4300.90.40 4311.20.00 4311.30.00 8932.40.00 4000.90.07 4026.10.00 4027.30.00 8937.40.00	430 20 MFZ430 430W2GTZ 400 20 MFZ2/400X 400WGVZ 430 20 MFZ430 430W2GTZ KZISZ - 5 400 20 MFZ2/400X 400WGVZ KZISZ-5	- Engine code: MIDR063540J/3, MIDR063540P/41 - GBox: B9+35mm,B18 - To model year: 08/1996 - Engine code: MIDR063540J/3, MIDR063540P/41 - GBox: B9+35mm,B18 - To model year: 08/1996 - Engine code: MIDR063540J/3, MIDR063540P/41 - GBox: B9+35mm,B18 - To model year: 09/1996 - Engine code: MIDR063540J/3, MIDR063540P/41 - GBox: B9+35mm,B18 - To model year: 09/1996
AE 430.19 11ATA1 AE 430.19T 11GTA1 AE 470.19 11ATA1 AE 470.19T 11GTA1	09.96 - 09.96 - 11.96 - 11.96 -	MIDR 06.24.65 B/42 MIDR 06.24.65 C/42	4300.90.61 ⊕ 4311.20.00 4311.30.00 8937.40.00 4300.90.40 4311.20.00 4311.30.00 8932.40.00 4000.90.07 4026.10.00 4027.30.00 8937.40.00 4000.90.12 4026.10.00 4029.30.00 8941.40.00 4000.90.13 4026.10.00 4029.30.00 8937.40.00	430 20 MFZ430 430W2GTZ KZISZ-5 430 20 MFZ430 430W2GTZ KZISZ - 5 400 20 MFZ2/400X 400WGVZ KZISZ-5 400 10 MFZ2/400X 400GTZ KZISZ-5 400 10 MFZ2/400X 400GTZ KZISZ-5	- GBox: B9 - GBox: B9+35mm,B18 - GBox: B9+35mm,B18 - GBox: ZF 16S 221 - To model year: 11/1997 - GBox: ZF 16S 221 - To model year: 11/1997
AE 500. (11CWA1)	01.92 -		4000.90.19 ⊕ 4036.10.00 4027.30.00	400 20 MFZ2/400X 400WGVZ	- Engine code: MackEE9
AE 520.19 11AWA1 AE 520.19T 11GWA1 AE 520.22T 11KWA1 AE 520.24 11CWA3	10.92 - 05.96 10.92 - 05.96 10.92 - 05.96 10.92 - 05.96	Mack-EE9-530	4000.90.07 4026.10.00 4027.30.00 8937.40.00	400 20 MFZ2/400X 400WGVZ KZISZ-5	- Engine code: MackEE9 - GBox: B9+35mm,B18 - From model year: 04/1995
AE 560.19 11AWA1 AE 560.19T 11GWA1	04.96 - 04.96 -	Mack-EE9-560	4000.90.20 4029.10.00 4037.30.00 8937.40.00	400 20 MFZ2/400X 400WGTZ KZISZ-5	- Engine code: MackEE9 - GBox: B9+35mm,18 - Vehicles with double disc clutch

Vehicle list

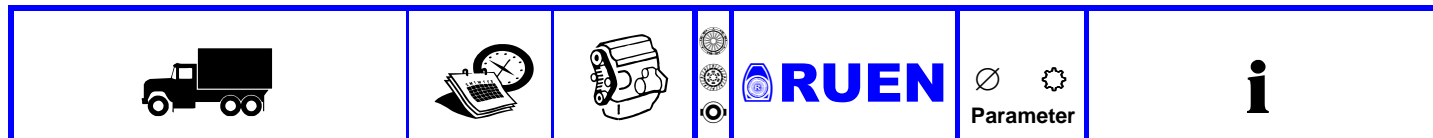

RENAULT TRUCKS

Magnum

09.90 -

DXi 13 440.19 17SF00100004	03.09 -	DXi 13		4398.30.00	430 24 430WGTZ	- Engine code: DXi 13 - GBox: AT2412C/AT2512C, ATO2512C
DXi 13 440.19 17TF00100014	03.09 -			8641.47.00	PHIS-6/38	- Engine code: DXi 13 - GBox: AT2412C/AT2512C, ATO2512C
DXi 13 480.19 17SF00100006	03.09 -			4300.90.117	430 10 MFZ430	- Engine code: DXi 13 - GBox: ZF 16S-2520 TO, ZF 16S-2320 TD
DXi 13 480.19	03.09 -			4395.20.00	430WGTZ	- Vehicles with single clutch disc
DXi 13 480.26 17RF00100006	03.09 -			4399.30.00	KZISZ - 5	
DXi 13 480.26 17JF00100006	03.09 -			8933.40.00		
DXi 13 520.18 17TF00100008	08.09 -			4000.90.12	400 10 MFZ2/400X	- Engine code: DXi 13 - GBox: ZF 16S-2520 TO, ZF 16S-2320 TD
DXi 13 520.19 17SF00100008	08.09 -			4026.10.00	400GTZ	- Vehicles with double disc clutch
DXi 13 520.19 17TF00100008	08.09 -			4029.30.00	KZISZ-5	
DXi 13 520.24	08.09 -			8941.40.00		
DXi 13 520.25, Platform/Chassis, 6x2	08.09 -			4300.90.116	430 10 MFZ430	- Engine code: DXi 13 - GBox: 16S2230
DXi 13 520.25, Truck Tractor, 6x2	08.09 -			4395.20.00	430WGTZ	
DXi 13 520.26	08.09 -			4399.30.00		
DXi 13 520.26 17JF00100008	08.09 -			8949.40.00		

Major

05.91 - 10.96

R 340ti.16/T RG08A1X	05.91 - 10.96	MIDR 06.20.45 E MIDR 06.20.45 E2 MIDR 06.20.45 E3		4311.30.00	430 20 430W2GTZ	
R 340ti.18 RA08A1, RA08A1E, Dump Truck, 4x2	05.91 - 10.96			8936.40.00	KZISZ - 5	
R 340ti.18 RA08A1, RA08A1E, Platform/Chassis, 4x2	05.91 - 10.96			4300.90.349	430 20 MFZ430	- GBox: B9
R 340ti.24 RC08E1	05.91 - 10.96			4311.26.00	430W2GTZ	
				8936.46.00	KZISZ-5	
				4300.90.99	430 20 MFZ430	- GBox: B9+35mm,B18
				4311.26.00	430W2GTZ	
				4311.30.00	430	
				8938.46.00	MFZ430	
				4343.30.00	430 10 430GTZ	
R 340ti.18/T RG08A1, RG08A1E	05.91 - 10.96	MIDR 06.20.45 E MIDR 06.20.45 E2 MIDR 06.20.45 E3 MIDR 06.35.40 G		4311.30.00	430 20 430W2GTZ	
R 340ti.26 RC08C1	05.91 - 10.96			8936.40.00	KZISZ - 5	
R 350.18/T	05.91 - 12.92			4000.90.19 ⊕	400 20 MFZ2/400X	- Vehicles with double disc clutch
				4036.10.00	400WGVZ	
				4027.30.00		
				4300.90.99	430 20 MFZ430	- GBox: B9+35mm,B18
				4311.26.00	430W2GTZ	
				4311.30.00	430	
			8938.46.00	MFZ430		
			4311.26.00	MFZ430		

Vehicle list



































RENAULT TRUCKS

Major		05.91 - 10.96				
R 350.17, 17.00t, Platform/Chassis R 350.17/T R 350.18, Dump Truck, 4x2 R 350.18, 18.00t, Platform/Chassis R 350.26	05.91 - 12.92	MIDR 06.35.40 G	4311.30.00	430 20 430W2GTZ		
	05.91 - 12.92		8936.40.00	KZISZ - 5		
	05.91 - 12.92		4300.90.99	430 20 MFZ430 430W2GTZ	- GBox: B9+35mm - From model year: 10/1992	
	05.91 - 12.92		4311.26.00 4311.30.00 8938.46.00			
			4300.90.349	430 20 MFZ430 430W2GTZ KZISZ-5	- GBox: B9 - From model year: 10/1992	
			4343.30.00	430 10 430GTZ		
		4311.26.00	430 MFZ430			
R 380.25	05.91 - 12.92	MIDR 06.35.40 H	4311.30.00	430 20 430W2GTZ		
			8936.40.00	KZISZ - 5		
			4300.90.349	430 20 MFZ430 430W2GTZ KZISZ-5	- GBox: B9 - From model year: 10/1992	
			4311.26.00 4311.30.00 8936.46.00			
			4300.90.99	430 20 MFZ430 430W2GTZ	- From model year: 10/1992 - GBox: B9+35mm,B18	
			4343.30.00	430 10 430GTZ		
		4311.26.00	430 MFZ430	- GBox: B9+35mm,B18 - GBox: B9		
R 385ti.18,R 380.18 RA04A1, Dump Truck, 4x2 R 385ti.18,R 380.18 RA04A1, Platform/Chassis, 4x2 R 385ti.18/T,R 380.18/T RG04A1E, RG04A1, RG04E1 R 385ti.24,R 380.24 RC04E1 R 385ti.25,R 380.25 R 385ti.25/T,R 380.25/T R 385ti.26 RD04C1 R 385ti.26 RD04A1, RD04C1 R 385ti.26,R 380.26 RC04C1, RC04D1, RC04B1 R 385ti.26/T,R 380.26/T RK04B1, RK04A1	05.91 - 10.96	MIDR 06.35.40 H	4311.30.00	430 20 430W2GTZ		
	05.91 - 10.96		8936.40.00	KZISZ - 5		
	05.91 - 10.96		4300.90.99	430 20 MFZ430 430W2GTZ	- From model year: 10/1992 - GBox: B9+35mm,B18	
	05.91 - 10.96		4311.26.00 4311.30.00 8938.46.00			
	05.91 - 10.96		4300.90.349	430 20 MFZ430 430W2GTZ KZISZ-5	- From model year: 10/1992 - GBox: B2	
	12.91 - 10.96		4343.30.00	430 10 430GTZ		
	12.91 - 10.96		4300.90.46	430 10 MFZ430 430GTZ	- From model year: 10.1992 - GBox: Eaton	
	05.91 - 10.96		4335.60.00 4327.30.00			
	05.91 - 10.96		4311.26.00	430 MFZ430	- GBox: B9+35mm,B18	
	10.92 - 10.96		MIDR 06.35.40 J/3 MIDR 06.35.40 J1	4300.90.99	430 20 MFZ430 430W2GTZ	- GBox: B9+35mm,B18
	04.92 - 10.96			4311.26.00 4311.30.00 8938.46.00		
	04.92 - 10.96			4000.90.19	400 20 MFZ2/400X 400WGVZ	
04.92 - 10.96	4036.10.00 4027.30.00					

Vehicle list

					
---	---	---	--	---	---

RENAULT TRUCKS

Major		05.91 - 10.96				
RI 357	- 09.92		 4311.30.00	430 20 430W2GTZ		
			 8936.40.00	KZISZ - 5		
			 4343.30.00	430 10 430GTZ		
360	04.82 -		 4311.30.00	430 20 430W2GTZ		
			 8936.40.00	KZISZ - 5		
360	01.86 -		 4343.30.00	430 10 430GTZ		
			 8936.40.00	KZISZ - 5		
360	- 12.86		 4343.30.00	430 10 430GTZ	- GBox: Fuller	
R 340ti.17 RA08A1	05.91 - 10.96	MIDR 06.20.45 E	 4311.30.00	430 20 430W2GTZ	- GBox: B9/B18	
R 340ti.18 RA08A1	05.91 - 10.96	MIDR 06.20.45 E2	 8936.40.00	KZISZ - 5	- To model year: 09/1992	
R 340ti.19 RA08A1	05.91 - 10.96	MIDR 06.20.45 E3			- GBox: Fuller	
R 340ti.19/T RG08A1	05.91 - 10.96	MIDR 06.35.40 G			- GBox: B9/B18	
R 350.17, 17.50t, Platform/Chassis	05.91 - 12.92	MIDR 06.35.40 H			- To model year: 09/1992	
R 350.18, 18.50t, Platform/Chassis	05.91 - 12.92	MIDR 06.35.40 L1	 4300.90.349	430 20 MFZ430	- GBox: Eaton	
R 350.19	05.91 - 12.92	MIDR 06.35.40 N/3	 4311.26.00	430W2GTZ	- GBox: B9	
R 350.19/T	05.91 - 12.92		 4311.30.00	KZISZ-5		
R 350.19/TB	05.91 - 12.92		 8936.46.00			
R 350.24	05.91 - 10.92		 4300.90.99	430 20 MFZ430	- GBox: B9+35mm,B18	
R 380.22/T	05.91 - 12.92		 4311.26.00	430W2GTZ		
R 385ti.17,R 380.17 RA04A1, RA04A1X	05.91 - 10.96		 4311.30.00			
R 385ti.18,R 380.18 RA04A1, RA04A1X	05.91 - 10.96		 8938.46.00			
R 385ti.19,R 380.19 RA04A1, RA04A1X	05.91 - 10.96		 4343.30.00	430 10 430GTZ	- GBox: Eaton	
R 385ti.19/T,R 380.19/T RG04A1E, RG04A1, RG04E1	05.91 - 10.96				- GBox: Fuller	
R 385ti.22/T,R 380.19/TB RG04A1E, RG04C1	05.91 - 10.96				- GBox: Eaton RTX 14613	
R 420ti.19/T RG04A1E, RG04A1, RG04E1	10.92 - 10.96	MIDR 06.35.40 J/3	 4300.90.99	430 20 MFZ430	- GBox: B9+35mm,B18	
R 420ti.19/T	10.92 - 10.96		 4311.26.00	430W2GTZ		
R 420ti.22/T RG04A1E, RG04C1	10.92 - 10.96		 4311.30.00			
			 8938.46.00			
			 4000.90.19 ⊕	400 20 MFZ2/400X		
			 4036.10.00	400WGVZ		
			 4027.30.00			
Manager		09.91 - 10.96				
G 230ti.13 BA07C4	09.91 - 03.93	MIDR 06.02.26 D	 3866.20.00	380 GM380K	- GBox: G406/406	
G 230ti.15 BA07C3	09.91 - 03.93	MIDR 06.02.26 X				
G 230ti.16 BA07C2, BA07C2X	09.91 - 10.96					
G 230ti.16 BA07C2, BA07C2XX	09.91 - 10.96					
G 230ti.17 BA07C1, BA07C1X	09.91 - 10.96					
G 230ti.18 BA07C7, BA07C7X, Dump Truck, 4x2	05.92 - 10.96					
G 230ti.18 BA07C7, BA07C7X, Platform/Chassis, 4x2	05.92 - 10.96					
G 270.18,G 270.17 BA02A7X, BA02A7	11.92 - 10.96	MIDR 06.20.45 B3	 4300.90.350 ⊕	430 20 MFZ430	- Engine code: MIDRO62045B/3	
			 4335.60.00	430W2GTZ	- GBox: B9+35mm/B18	
			 4311.30.00			
			 4300.90.48 ⊕	430 20 MFZ430	- GBox: B9	
			 4335.60.00	430W2GTZ		
			 4311.30.00			

Vehicle list



RENAULT TRUCKS

Manager		09.91 - 10.96			
G 280.13,G 270.13 BA02F1 G 280.15,G 270.15 BA02G2 G 280.15/T,G 270.15/T BG02A1 G 280.16 BA02K1, BA02K1X G 280.16,G 270.16 BA02K1, BA02K1XX G 280.17,G 270.18 BA02M1X, BA02M1 G 280.17/T,G 270.17/T G 280.18,G 270.18,G 270.17 BA02A7X, BA02A7 G 280.24 BC02D1 G 280.26,G 270.26 BC02B1A, BC02B1AX, BC02B1X, BC02A2, BC02B1, BC02D1X, BC02A2X, BC02D1	09.91 - 10.96 09.91 - 10.96 09.91 - 10.96 09.91 - 03.93 09.91 - 10.96 09.91 - 10.96 09.91 - 10.96 09.91 - 10.96 09.91 - 03.93 09.91 - 10.96	MIDR 06.20.45 B3 MIDS 06.20.45 B	4342.30.00	430 20 430GTZ	- Engine code: MIDS062045B - GBox: B9,B18 - To model year: 09/1992
			8936.40.00	KZISZ - 5	
			4300.90.48 ⊕	430 20 MFZ430	- Engine code: MIDS062045B - GBox: B9 - From model year: 10/1992
			4335.60.00 4311.30.00	430W2GTZ	
			4300.90.350 ⊕	430 20 MFZ430	- Engine code: MIDS062045B - GBox: B9+35mm,B18
			4335.60.00 4311.30.00	430W2GTZ	
			4300.90.75 ⊕	430 10 MFZ430	- Engine code: MIDS062045B - GBox: Fuller
			4327.30.00	430GTZ	
			4291.30.00	420 10 420GSZ	- Engine code: MIDS062045B - GBox: ZF 16S-130
			4343.30.00	430 10 430GTZ	- Engine code: MIDS062045B - GBox: Fuller
G 300.13 BA02F1 G 300.15 BA02G2 G 300.16 BA02K1, BA02K1XX G 300.16 BA02K1, BA02K1X G 300.17 BA02M1X, BA02M1 G 300.17/T BG02N2 G 300.18 BA02A7X, BA02A7, Dump Truck, 4x2 G 300.18 BA02A7X, BA02A7, Platform/Chassis, 4x2 G 300.18 BB02A1 G 300.24, Dump Truck, 6x4 G 300.24 BC02D1 G 300.24, Platform/Chassis, 6x4 G 300.25 BD02A1, Dump Truck, 6x4 G 300.25 BD02A1, Platform/Chassis, 6x4 G 300.26 BD02A2, BD02A1X, BD02A1, Dump Truck, 6x4 G 300.26 BD02A2, BD02A1X, BD02A1, Platform/Chassis, 6x4	09.91 - 10.96 09.91 - 10.96 09.91 - 10.96 09.91 - 10.96 09.91 - 10.96 09.92 - 10.96 09.92 - 10.96 09.92 - 10.96 09.91 - 10.96 09.91 - 10.96 09.91 - 10.96 09.91 - 10.96 09.91 - 10.96	MIDR 06.20.45 D MIDR 06.20.45 D3	4342.30.00	430 20 430GTZ	- GBox: B9,B18 - To model year: 09/1992
			8936.40.00	KZISZ - 5	- GBox: B9,B18 - GBox: ZF S6-90 - To model year: 09/1992
			4300.90.48 ⊕	430 20 MFZ430	- GBox: B9 - From model year: 10/1992
			4335.60.00 4311.30.00	430W2GTZ	
			4300.90.350 ⊕	430 20 MFZ430	- GBox: B9+35mm,B18 - From model year: 10/1992
			4335.60.00 4311.30.00	430W2GTZ	
			4312.30.00	430 10 430W2GTZ	- GBox: ZF S6-90 - From model year: 10/1992
			4291.30.00	420 10 420GSZ	- GBox: ZF 16S-130+
			4311.30.00	430 20 430W2GTZ	- GBox: B9,B9+35mm,B18 - From model year: 10/1992
			4343.30.00	430 10 430GTZ	- GBox: ZF 16S-130, Eaton RTXF 116 - To model year: 09/1992
			G 330.13 BA02F1 G 330.15 BA02G2 G 330.17 G 330.18 G 330.24 BC02D1 G 330.26 BD02A2, BD02A1X, BD02A1	09.91 - 03.93 09.91 - 03.93 09.91 - 03.93 09.91 - 03.93 09.91 - 03.93 09.91 - 03.93	MIDR 06.20.45 H
8936.40.00	KZISZ - 5	- Engine code: MIDR062045H - GBox: B9/B18 - From model year: 10/1992			
4291.30.00	420 10 420GSZ	- Engine code: MIDR062045H - GBox: ZF 16S-130			
4343.30.00	430 10 430GTZ	- Engine code: MIDR062045H - GBox: Eaton RTXF 116			

Vehicle list



RENAULT TRUCKS

Manager		09.91 - 10.96			
G 340ti.16,G 330.16 BA02K1, BA02K1XX	09.91 - 10.96	MIDR 06.20.45 E	4311.30.00	430 20 430W2GTZ	- Engine code: MIDR062045H - GBox: B9/B18 - To model year: 09/1992
G 340ti.16,G 330.16 BA02K1, BA02K1XX	09.91 - 10.96	MIDR 06.20.45 E2	8936.40.00	KZISZ - 5	- Engine code: MIDR062045H - GBox: B9/B18 - To model year: 09/1992
G 340ti.17,G 330.19 BA02W1, BA02M1X, BA02M1	09.91 - 10.96	MIDR 06.20.45 E3			
G 340ti.17/T,G 330.17/T BG02N2, BG06A3, BG06A7	09.91 - 10.96	MIDR 06.20.45 H	4300.90.350	430 20 MFZ430	- Engine code: MIDR062045H - GBox: B9+35mm,B18 - From model year: 10/1992
G 340ti.18,G 330.18 BA02A7X, BA02A7	09.91 - 10.96		4335.60.00	430W2GTZ	- From model year: 10/1992
G 340ti.18/T BG02N2	02.92 - 10.96		4311.30.00		
G 340ti.26,G 330.26 BC02D1X, BC02D1	10.91 - 10.96		4300.90.48		
			4335.60.00	430 20 MFZ430	- Engine code: MIDR062045H - GBox: B9 - From model year: 10/1992
			4311.30.00	430 10 MFZ430	- Engine code: MIDR062045H - GBox: Eaton - From model year: 10/1992
			4300.90.75	430 10 430GTZ	- Engine code: MIDR062045H - GBox: Eaton - From model year: 10/1992
			4343.30.00	430 10 430GTZ	- Engine code: MIDR062045H - GBox: Eaton - GBox: ZF 16S-130 - From model year: 10/1992
G 200.13 BA07A4	09.91 - 03.93	MIDR 06.02.26 H	3500.90.42	350 10 14" MF 350	- Engine code: MIDRO60226H - GBox: ZFS6.36S
G 200.15 BA07A3	09.91 - 03.93	MIDR 06.02.26 Q	3574.20.00	350GSZ	
G 200.16 BA07A2, 16.00t, Platform/Chassis	09.91 - 03.93	MIDR 06.02.26 W	3587.30.00	KZIS-3	
G 200.16 BA07A2, 16.50t, Platform/Chassis	09.91 - 03.93		8525.40.00		
G 200.17 BA07A1	09.91 - 03.93				
G 200.18 BA07A7	09.91 - 03.93				
G 210.16 BA07A2	05.92 - 10.96				
G 210.18 BA07A7	05.92 - 10.96				
G 230.13 SP BA03X2	09.91 - 03.93	MIDR 06.02.26 D	3866.20.00	380 GM380K	- Engine code: MIDS062030P - GBox: 6.69,B6
G 230ti.19 BA07B1X, BA07B1	09.91 - 10.96	MIDR 06.02.26 X			
G 230ti.19 BA07B1	09.91 - 10.96	MIDS 06.20.30 P			
G 270.13 SP	03.93 - 10.96	MIDR 06.20.45 B3	4300.90.350	430 20 MFZ430	- Engine code: MIDRO62045B/3 - GBox: B9+35mm/B18
G 270.14 SP BA02X2	03.93 - 10.96		4335.60.00	430W2GTZ	- Engine code: MIDRO62045B/3 - GBox: B2
			4311.30.00		
			4300.90.48	430 20 MFZ430	
			4335.60.00	430W2GTZ	- Engine code: MIDRO62045B/3 - GBox: B2
			4311.30.00		
G 280.19 BA02W1	09.91 - 03.93	MIDR 06.20.45 B3	4342.30.00	430 20 430GTZ	- GBox: B9,B18 - To model year: 09/1992 - Engine code: MIDS062045B
G 280.19,G 270.19 BA02W1, BA02A0, BA02W1X	09.91 - 10.96	MIDS 06.20.45 B	8936.40.00	KZISZ - 5	- Engine code: MIDS062045B - GBox: B9,B18 - To model year: 09/1992
			4300.90.48	430 20 MFZ430	- To model year: 10/1992 - GBox: B9 - Engine code: MIDS062045B
			4335.60.00	430W2GTZ	- GBox: B9+35mm,B18 - Engine code: MIDS062045B
			4311.30.00		
			4300.90.350	430 20 MFZ430	
			4335.60.00	430W2GTZ	- GBox: B9+35mm,B18 - Engine code: MIDS062045B
			4311.30.00		
			4300.90.75	430 10 MFZ430	- GBox: Fuller - Engine code: MIDS062045B
			4335.60.00	430GTZ	- Engine code: MIDS062045B
			4327.30.00		
			4291.30.00	420 10 420GSZ	- Engine code: MIDS062045B - GBox: ZF 16S-130

Vehicle list



RENAULT TRUCKS

Manager		09.91 - 10.96			
G 300.15/T BG02A1 G 300.19 BA02W1, BA02W1X G 300.19 BA02W1, BA02A0, BA02W1X G 300.19/T BG06A1, BG06A1C G 300.19/T BG06A1, BG06A1X G 300.26 CIT BC02B1A, BC02B1X, BC02A2, BC02B1, BC02D1X, BC02A2X, BC02B1A1, BC02D1 G 300.26/T	09.91 - 10.96	MIDR 06.20.45 D	4342.30.00	430 20 430GTZ	- GBox: B9,B18 - To model year: 09/1992
	09.91 - 03.93	MIDR 06.20.45 D3	8936.40.00	KZISZ - 5	- GBox: B9,B18 - GBox: ZF S6-90 - To model year: 09/1992
	09.91 - 10.96		4300.90.48 ⊕ 4335.60.00 4311.30.00	430 20 MFZ430 430W2GTZ	- GBox: B9 - From model year: 10/1992
	09.91 - 10.96		4300.90.350 ⊕ 4335.60.00 4311.30.00	430 20 MFZ430 430W2GTZ	- GBox: B9+35mm,B18 - From model year: 10/1992
	09.91 - 10.96		4312.30.00	430 10 430W2GTZ	- GBox: ZF S6-90 - From model year: 10/1992
	09.91 - 10.96		4291.30.00	420 10 420GSZ	- GBox: ZF 16S-130+
	09.91 - 10.96		4311.30.00	430 20 430W2GTZ	- Engine code: MIDR062045H - GBox: B9/B18 - From model year: 10/1992
G 330.19 BA02W1	09.91 - 03.93	MIDR 06.20.45 H	8936.40.00	KZISZ - 5	- Engine code: MIDR062045H - GBox: B9/B18 - From model year: 10/1992
			4291.30.00	420 10 420GSZ	- Engine code: MIDR062045H - GBox: ZF 16S-130
			4343.30.00	430 10 430GTZ	- Engine code: MIDR062045H - GBox: Eaton RTXF 116
			4311.30.00	430 20 430W2GTZ	- Engine code: MIDR062045H - GBox: B9/B18 - To model year: 09/1992
G 340ti.19,G 330.19 BA02W1, BA02W1X G 340ti.19/T,G 330.19/T BG06A1, BG06A1C G 340ti.19/T,G 330.19/T,G 330.17/T BG02N2, BG06A1, BG02N2X, BG06A1X	09.91 - 10.96	MIDR 06.20.45 E	8936.40.00	KZISZ - 5	- Engine code: MIDR062045H - GBox: B9/B18 - To model year: 09/1992
	09.91 - 10.96	MIDR 06.20.45 E2	4300.90.350 ⊕ 4335.60.00 4311.30.00	430 20 MFZ430 430W2GTZ	- Engine code: MIDR062045H - GBox: B9+35mm,B18 - From model year: 10/1992
	09.91 - 10.96	MIDR 06.20.45 E3	4300.90.48 ⊕ 4335.60.00 4311.30.00	430 20 MFZ430 430W2GTZ	- Engine code: MIDR062045H - GBox: B9 - From model year: 10/1992
	09.91 - 10.96	MIDR 06.20.45 H	4300.90.75 ⊕ 4335.60.00 4327.30.00	430 10 MFZ430 430GTZ	- Engine code: MIDR062045H - GBox: Eaton - From model year: 10/1992
			4343.30.00	430 10 430GTZ	- Engine code: MIDR062045H - GBox: Eaton - GBox: ZF 16S-130 - From model year: 10/1992
			4335.60.00 ⊕	430 MFZ430	- GBox: G406/409, G406/409 ACS - From model year: 07/1995 - Engine code: MIDS062045J
			8936.40.00	KZISZ - 5	- GBox: G406/409, G406/409 ACS - From model year: 07/1995 - Engine code: MIDS062045J
G 220.17 BOM BA02W4, 17.50t, Utility truck G 220.17 BOM BA02W4, 15.99t, Utility truck G 220.19 BOM BA02W3	09.91 - 10.96	MIDS 06.20.45 J	4335.60.00 ⊕	430 MFZ430	- GBox: G406/409, G406/409 ACS - From model year: 07/1995 - Engine code: MIDS062045J
	09.91 - 10.96	MIDS 06.20.45 J3	8936.40.00	KZISZ - 5	- GBox: G406/409, G406/409 ACS - From model year: 07/1995 - Engine code: MIDS062045J
	09.91 - 10.96				
Maxter		10.92 - 06.97			
G 280.18, Dump Truck, 4x2 G 280.18, Platform/Chassis, 4x2 G 280.18/T	10.92 - 03.93	MIDS 06.20.45 B	4300.90.350 ⊕ 4335.60.00 4311.30.00	430 20 MFZ430 430W2GTZ	- GBox: B9+35mm,B18 - Engine code: MIDS062045B
	10.92 - 03.93		4300.90.48 ⊕ 4335.60.00 4311.30.00	430 20 MFZ430 430W2GTZ	- GBox: B9 - Engine code: MIDS062045B







Vehicle list

















RENAULT TRUCKS

Maxter		10.92 - 06.97				
G 300.18 BA02W1, BA02W1X, Dump Truck, 4x2	10.92 - 10.96	MIDR 06.20.45 D		4300.90.350 ⊕	430 20	- GBox: B9+35mm,B18
G 300.18 BB02A1, Dump Truck, 4x4	10.92 - 10.96	MIDR 06.20.45 D/41		4335.60.00	MFZ430	
G 300.18 BA02W1, BA02W1X, Platform/Chassis, 4x2	10.92 - 10.96	MIDR 06.20.45 D3		4311.30.00	430W2GTZ	
G 300.18 BB02A1, Platform/Chassis, 4x4	10.92 - 10.96	MIDR 06.20.45 E/41		4300.90.48 ⊕	430 20	- GBox: B9
G 300.19 BA02E4X, BA02E4	02.96 - 06.97	MIDR 06.20.45 E3		4335.60.00	MFZ430	
G 300.19 BB02E4	02.96 - 06.97			4311.30.00	430W2GTZ	
G 300.19 BB02A1	10.92 - 10.96					
G 300.19 BA02W1, BA02W1X	10.92 - 10.96					
G 300.19	10.92 - 10.96					
G 300.19/T	10.92 - 10.96					
G 300.26 BD02E32, BD02E2X, BD02E2, BD02E32X, Concrete Mixer, 6x4	10.92 - 10.96					
G 300.26 BD02E32, BD02E2X, BD02E2, BD02E32X, Concrete Mixer, 8x4/4	10.92 - 10.96					
G 300.26 BD02E32, BD02E2X, BD02E2, BD02E32X, Dump Truck, 6x4	10.92 - 10.96					
G 300.26 BD02E32, BD02E2X, BD02E2, BD02E32X, Platform/Chassis, 6x2	10.92 - 10.96					
G 300.26 BD02E32, BD02E2X, BD02E2, BD02E32X, Platform/Chassis, 6x4	10.92 - 10.96					
G 340ti.19 BA02E4X, BA02E4	10.92 - 06.97					
G 340ti.19 BH02E41	10.92 - 06.97					
G 340ti.19/T BH02E41, Truck Tractor, 4x2	10.92 - 06.97					
G 340ti.19/T BH02E41, Truck Tractor, 4x4	10.92 - 06.97					
G 340ti.25/A,G 340ti.25/B BD02E3, Dump Truck, 6x4	10.92 - 06.97					
G 340ti.25/A,G 340ti.25/B BD02E3, Platform/Chassis, 6x4	10.92 - 06.97					
G 340ti.26 BD02E31, BD02E32, BD02E2X, BD02E21, BD02E31X, BD02E2, BD02E21X, BD02E32X, Concrete Mixer, 6x4	10.92 - 06.97					
G 340ti.26,G 340ti.26/B BD02E31, BD02E32, BD02E2X, BD02E21, BD02E31X, BD02E2, BD02E21X, BD02E32X	10.92 - 06.97					
G 340ti.26/B BD02E31, BD02E32, BD02E2X, BD02E21, BD02E31X, BD02E2, BD02E21X, BD02E32X, Platform/Chassis, 6x4	10.92 - 06.97					
G 340ti.26/C BE02E1, Dump Truck, 6x6	10.92 - 06.97					
G 340ti.26/C BE02E1, Platform/Chassis, 6x6	10.92 - 06.97					
G 340ti.32,G 340ti.32/B BF02E1X, BF02E11, BF02E2, BF02E1, BF02E11X, BF02E2X, BF02E5	10.92 - 06.97					
G 340ti.32/A,G 340ti.32/B,G 340ti.32/C BF02E1X, BF02E11, BF02E2, BF02E1, BF02E11X, BF02E2X, BF02E5, Concrete Mixer, 8x4/4	10.92 - 06.97					
G 340ti.32/A,G 340ti.32/B,G 340ti.32/C BF02E1X, BF02E11, BF02E2, BF02E1, BF02E11X, BF02E2X, BF02E5, Platform/Chassis, 8x4/4	10.92 - 06.97					
G 340ti.34 BD02E4X, BE02E4, Platform/Chassis, 6x4	10.92 - 06.97					

Vehicle list

					
---	---	---	--	---	---

RENAULT TRUCKS

Maxter		10.92 - 06.97				
G 340ti.34 BD02E4X, BE02E4, Dump Truck, 6x4	10.92 - 06.97	MIDR 06.20.45 E/41		4300.90.350 ⊕ ⊙ 4335.60.00 ⊙ 4311.30.00	430 20 MFZ430 430W2GTZ	- GBox: B9+35mm, B18
G 340ti.34 BE02E1X, BE02E1	10.92 - 06.97	MIDR 06.20.45 E3				
G 340ti.40 BF02E34, BF02E34X, BF02E3X, BF02E3, Dump Truck, 8x4/4	10.92 - 06.97			4300.90.48 ⊕ ⊙ 4335.60.00 ⊙ 4311.30.00	430 20 MFZ430 430W2GTZ	- Engine code: MIDRO62045E - GBox: B9
G 340ti.40 BF02E34, BF02E34X, BF02E3X, BF02E3, Platform/Chassis, 8x4/4	10.92 - 06.97			4000.90.19 ⊕ ⊙ 4036.10.00 ⊙ 4027.30.00	400 20 MFZ2/400X 400WGVZ	- Engine code: MIDRO62045E - GBox: 9/B18
				4300.90.75 ⊕ ⊙ 4335.60.00 ⊙ 4327.30.00	430 10 MFZ430 430GTZ	- Engine code: MIDRO62045E - GBox: Fuller
G 230ti.19 BA07B1X, BA07B1, Dump Truck, 4x2	10.92 - 05.95	MIDR 06.02.26 D		3863.20.00	380 GM380	
G 230ti.19 BA07B1X, BA07B1, Platform/Chassis, 4x2	10.92 - 05.95	MIDR 06.02.26 X				
Messenger		05.92 - 06.99				
B 80	01.92 -			3233.40.00	KZAS - 0B	- Engine code: SOFIM 8140.07 - GBox: ZF S5.18
B 110	11.92 -			2525.20.00	250 MF250	- Engine code: SOFIM 8140.27 - GBox: ZF S5.24 - To model year: 02/1993
B 120	11.92 - 02.93					
Midliner		09.83 - 01.00				
M 140.12/C 40ABF1, Platform/Chassis, 4x2	05.89 - 03.93	MIDS 06.02.12 C		3100.90.01 ⊙ 3169.20.00 ⊙ 3113.30.00 ⊙ 6905.40.00	310 10 MF310 310GSBL KZIS - 3	- Engine code: MIDS060212C - GBox: ZF S 5-35
				3500.90.42 ⊙ 3574.20.00 ⊙ 3587.30.00 ⊙ 8525.40.00	350 10 14" MF 350 350GSZ KZIS-3	- Engine code: MIDS060212 - GBox: ZF S 6-36
S 100.07/A, Platform/Chassis, 4x2	01.86 - 09.90	T 4.38		2822.20.00	280 MF280	- GBox: ZFS5-24
S 100.07/A, Dump Truck, 4x2	01.86 - 09.90					
S 100.08/A, Dump Truck, 4x2	01.86 - 09.90					
S 100.08/A, Platform/Chassis, 4x2	01.86 - 09.90					
S 120.07/A 40AAA1	09.90 - 11.92	T 4.40		3100.90.03 ⊙ 3179.20.00 ⊙ 3132.30.00 ⊙ 5501.40.00	310 10 MFZ310 310GSB KZISZ - 3	
S 120.08/A 40AAA3, Dump Truck, 4x2	09.90 - 11.92	T 4.40		3100.90.03 ⊙ 3179.20.00 ⊙ 3132.30.00 ⊙ 5501.40.00	310 10 MFZ310 310GSB KZISZ - 3	- From model year: 01.1992
S 120.08/A 40AAA3, Platform/Chassis, 4x2	09.90 - 11.92	T 4.40 A/3				
S 120.08/A 40AAA0, 40AAA3	11.92 - 10.94	T 4.40 CC				
S 130.08/A,S 130.08/B, Dump Truck, 4x2	09.83 - 01.90	797		3100.90.01 ⊙ 3169.20.00 ⊙ 3113.30.00 ⊙ 6905.40.00	310 10 MF310 310GSBL KZIS - 3	- Engine code: 797 - GBox: ZFS5-35
S 130.08/A,S 130.08/B, Platform/Chassis, 4x2	09.83 - 01.90					
S 130.09/B, Dump Truck, 4x2	09.83 - 01.90			3500.90.42 ⊙ 3574.20.00 ⊙ 3587.30.00 ⊙ 8525.40.00	350 10 14" MF 350 350GSZ KZIS-3	- Engine code: 797 - GBox: ZFS6-36
S 130.09/B, 9.00t, 4x2	09.83 - 01.90					
S 135.08/A,S 150.08/A 40AEA3, 40AAC1	05.96 - 01.00	MIDR 04.02.26 A/41		3100.90.03 ⊙ 3179.20.00 ⊙ 3132.30.00 ⊙ 5501.40.00	310 10 MFZ310 310GSB KZISZ - 3	
S 135.09/B,S 150.09/B 40AEB4	05.96 - 01.00	MIDR 04.02.26 B/41				

Vehicle list

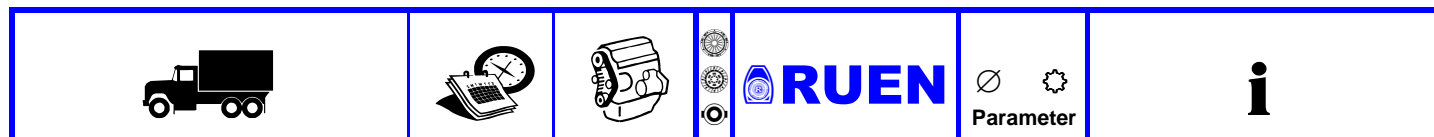

RENAULT TRUCKS

Midliner		09.83 - 01.00			
S 135.08/A 40AAC1, Dump Truck, 4x2 S 135.08/A 40AAC1, Platform/Chassis, 4x2	02.94 - 05.96 02.94 - 05.96	T 4.40 B/3	3100.90.03 3179.20.00 3132.30.00 5501.40.00	310 10 MFZ310 310GSB KZISZ - 3	
S 140.07/A JKSC24, 6.85t, Platform/Chassis S 140.07/A JKSC14, 6.00t, Platform/Chassis S 140.08/A,S 140.08/B JKSC12, JN1A16, Dump Truck, 4x2 S 140.08/A,S 140.08/B JKSC12, JN1A16, Platform/Chassis, 4x2 S 140.09/B JN1A12, Dump Truck, 4x2 S 140.09/B JN1A12, Platform/Chassis, 4x2	01.90 - 09.93 01.90 - 09.93 01.90 - 09.93 01.90 - 09.93 01.90 - 09.93 01.90 - 09.93	MIDS 06.02.12 C	3100.90.01 3169.20.00 3113.30.00 6905.40.00	310 10 MF310 310GSBL KZIS - 3	- GBox: ZF5-35/6-36
M 230.10/C 40ACC4	05.89 - 07.92	MIDR 06.02.26 D MIDR 06.02.26 S	3866.20.00	380 GM380K	- GBox: G406-1
M 250.13/C, Dump Truck, 4x2 M 250.13/C, Platform/Chassis, 4x2 M 250.15/C,M 250.15/D M 250.15C/T M 250.16/D 40ACD3, 40ACB3	05.96 - 01.00 05.96 - 01.00 05.96 - 01.00 05.96 - 01.00 05.96 - 01.00	MIDR 06.02.26 Y/41	3950.90.12 3957.20.00 3962.30.00 8535.40.00	395 10 MFZ395 395GTZ KZIZ - 4,5	
M 230.15/D 40ACD7, Dump Truck, 4x2	05.89 - 10.96	MIDR 06.02.26 D MIDR 06.02.26 S MIDR 06.02.26 X	3866.20.00	380 GM380K	- GBox: G409
S 220.13TI S 220.13TI/T S 220.14TI, Dump Truck, 4x2 S 220.14TI, 14.00t, 4x2 S 220.14TI/T	09.87 - 09.90 09.87 - 09.90 09.87 - 09.90 09.87 - 09.90 09.87 - 09.90	MIDR 06.02.26 MIDR 06.02.26 D	3866.20.00	380 GM380K	
M 140.11/T M 140.12/C 40ABF1, Utility truck, 4x2 M 140.13/T S 130.06 S 130.07 S 130.08/A S 130.08/B S 130.08/R S 130.09/B, 9.50t, 4x2 S 130.11 S 130.11/B, 10.00t, Platform/Chassis S 130.11/B, 11.50t, Platform/Chassis S 130.13/B	05.89 - 03.93 05.89 - 03.93 04.89 - 03.93 09.83 - 01.90 09.83 - 01.90 09.83 - 01.90 09.83 - 01.90 09.83 - 01.90 09.83 - 01.90 09.83 - 01.90 09.83 - 01.90 09.83 - 01.90 09.83 - 01.90 09.83 - 01.90	797 MIDS 06.02.12 C	3100.90.01 3169.20.00 3113.30.00 6905.40.00	310 10 MF310 310GSBL KZIS - 3	- Engine code: MIDS060212C - Engine code: 797 - GBox: ZF S 5-35
			3500.90.42 3574.20.00 3587.30.00 8525.40.00	350 10 14" MF 350 350GSZ KZIS-3	- Engine code: MIDS060212 - Engine code: 797 - GBox: ZF S 6-36

Vehicle list



RENAULT TRUCKS

Midliner		09.83 - 01.00				
M 140.13/C 40ABF2	04.89 - 03.93	MIDR 06.02.26 H	3500.90.42	350 10	- Engine code: MIDS060212	
	05.89 - 03.93	MIDR 06.02.26 U	3574.20.00	14" MF 350	- Engine code: MIDS060226U	
M 150.09/C 4x4JP4	11.92 - 10.96		3587.30.00	350GSZ	- GBox: ZF S 6-36	
M 150.09/C SP 4x4JP4	11.92 - 10.96	MIDR 06.02.26 U/4	8525.40.00	KZIS-3	- GBox: Fuller 4106A	
M 150.11/C 4x4JP5	11.92 - 10.96	MIDR 06.02.26 W			- GBox: ZF S5-35	
M 150.11/C SP 4x4JP5	11.92 - 10.96	MIDR 06.02.26 W/41			- GBox: ZF, RVIG406	
M 150.12/C 40ACC5	11.92 - 10.96	MIDS 06.02.12 B			- GBox: ZF S 6-36S	
M 150.12/C BTP 40ACC5	11.92 - 10.96	MIDS 06.02.12 C			- GBox: Eaton 4106B	
M 150.13/C 40ACA2	11.92 - 10.96					
M 150.13/C BTP 40ACA2	11.92 - 10.96					
M 150.14/C CIT 40ACA4	11.92 - 10.96					
M 160.12/C 40ABE1, Utility truck, 4x2	05.89 - 03.93					
M 160.12/C 40ABE1, Platform/Chassis, 4x2	05.89 - 03.93					
M 160.13/C 40ABE2, Dump Truck, 4x2	05.89 - 03.93					
M 160.13/C 40ABE2, Utility truck, 4x2	05.89 - 03.93					
M 160.13/C 40ABE2, Platform/Chassis, 4x2	05.89 - 03.93					
M 160.14/C BOM 40ABE3	05.89 - 03.93					
M 160.14/C CIT 40ABE4	05.89 - 03.93					
M 160.15/D 40ABH1	05.89 - 03.93					
M 200.10/C	05.88 - 03.93					
M 200.12/C 40ACA1	05.88 - 03.93					
M 200.13/C 40ACA2, Dump Truck, 4x2	05.88 - 03.93					
M 200.13/C	05.88 - 03.93					
M 200.13/C 40ACA2, Platform/Chassis, 4x2	05.88 - 03.93					
M 200.14/C BOM	05.88 - 03.93					
M 200.14/C CIT	05.88 - 03.93					
M 200.15/D 40ACB1, Dump Truck, 4x2	05.88 - 03.93					
M 200.15/D	05.88 - 03.93					
M 200.15/D 40ACB1, Platform/Chassis, 4x2	05.88 - 03.93					
M 200.16/D	05.88 - 03.93					
M 200.16/D 40ACB3	05.88 - 03.93					
M 210.13/C 40ACA2, Dump Truck, 4x2	05.92 - 01.00					
M 210.13/C SP JS00B5	05.92 - 10.96					
M 210.14/D	05.96 - 01.00					
M 210.15/D CIT 40ACD7	05.92 - 10.96					
M 210.16/D 40ACB3, Dump Truck, 4x2	05.92 - 01.00					
M 210.16/D	05.96 - 01.00					
M 210.16/D CIT 40ACB3C	05.92 - 10.96					
ME 160.13	05.89 - 03.93					
ME 160.15	05.89 - 03.93					
S 150.08/A	11.92 - 01.94					
S 150.08/A 40ACF4	05.96 - 01.00					
S 150.08/A 40ACF3	05.96 - 01.00					
S 150.08/A,S 150.08/B 40ACE1, 40ACE3, 40ACF3	11.92 - 01.94					

Vehicle list

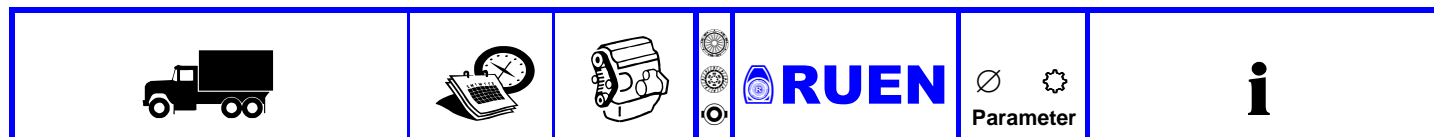

RENAULT TRUCKS

Midliner		09.83 - 01.00				
M 150.12/C 40ACC5	05.96 - 01.00	MIDR 06.02.26 U		3500.90.43	350 10	- Engine code: MIDS060226U
M 150.13/C 40ACA2	05.96 - 01.00	MIDR 06.02.26 U/4		3574.20.00	14" MF 350	- GBox: Fuller 4106A
M 150.14/C BOM 40ACA3	11.92 - 10.96	MIDR 06.02.26 V		3591.30.00	350WGTZ	- GBox: ZF S 6-36
M 180.10/C 4x4JP6A	11.92 - 10.96	MIDR 06.02.26 W		8525.40.00	KZIS-3	- GBox: Euro1/ZFS6-36
M 180.11/C 40ACA1, 4x4JP6	11.92 - 10.96	MIDR 06.02.26 W/41				- GBox: Eaton 4106A
M 180.11/C SP 40ACA1, 4x4JP6	11.92 - 10.96	MIDR 06.02.26 W				
M 180.12/C 40ACC5	11.92 - 10.96	MIDR 06.02.26 W/41				
M 180.12/C BTP 40ACC5	11.92 - 10.96					
M 180.13 SP 4x4JS3, JS00B1	11.92 - 10.96					
M 180.13/C 40ACA2, Dump Truck, 4x2	11.92 - 10.96					
M 180.13/C 40ACA2, Platform/Chassis, 4x2	11.92 - 10.96					
M 180.13/C 4x4JS3	11.92 - 10.96					
M 180.13/C 40ACA2, Dump Truck, 4x2	05.96 - 01.00					
M 180.13/C 40ACA2, Platform/Chassis, 4x2	05.96 - 01.00					
M 180.13/C BTP 40ACA2	11.92 - 10.96					
M 180.15/D 4x4JS4	11.92 - 10.96					
M 180.15/D 40ACB1	11.92 - 10.96					
M 180.15/D 40ACD7	11.92 - 10.96					
	10.96 - 01.00					
M 180.15/D BTP 40ACD7	11.92 - 10.96					
M 180.16/D 40ACB3	11.92 - 10.96					
	05.96 - 01.00					
M 210.12/C 40ACC5	05.92 - 01.00					
M 210.13/C 40ACA2, Platform/Chassis, 4x2	05.92 - 01.00					
M 210.14/C BOM 40ACA3	05.92 - 10.96					
M 210.15/D 40ACD7	05.92 - 01.00					
M 210.16/D 40ACB3, Platform/Chassis, 4x2	05.92 - 01.00					
M 230.15/D CIT	05.89 - 07.92	MIDR 06.02.26 D		3866.20.00	380	- Engine code: MIDR060226D
S 220.11TI	09.87 - 09.90	MIDR 06.02.26 S			GM380K	- GBox: G409
S 220.11TI 40ACE5	09.87 - 09.90					
S 220.14TI, 14.50t, 4x2	09.87 - 09.90					
S 90				2525.20.00	250	- Engine code: 720
S 90 09 BOM					MF250	- GBox: ZF S5-24
S 120.06/A 40AAA1	09.90 - 11.92	T 4.40		3100.90.03	310 10	- GBox: ZF S5-42
S 120.06/A,S 120.07/A 40AAA1	09.90 - 11.92	T 4.40 A/3		3179.20.00	MFZ310	
	11.92 - 10.94	T 4.40 CC		3132.30.00	310GSB	
S 120.07/A 40AAA2, Dump Truck, 4x2	09.90 - 11.92			5501.40.00	KZISZ - 3	
S 120.07/A 40AAA2	11.92 - 10.94			5501.40.00	KZISZ - 3	- GBox: ZF S5-42
S 120.08/A 40AAA4, Platform/Chassis, 4x2	09.90 - 11.92					
S 120.08/A 40AAA4, Utility truck, 4x2	09.92 - 11.92					
S 120.08/A 40AAA0, 40AAA4	11.92 - 10.94					
S 120.09/A, 7.75t, Utility truck	11.92 - 10.94					
S 120.09/A, 7.50t, Utility truck	11.92 - 10.94					
S 120.09/B 40AAB4	11.92 - 10.94					
S 120.09/B BOM 40AAB3, 40AAB3A	09.90 - 11.92					
S 120.09/B BOM	11.92 - 10.94					
S 120.09/B CIT 40AAB1	09.90 - 11.92					

Vehicle list



RENAULT TRUCKS

Midliner						09.83 - 01.00	
S 120.07/A 40AAA2, Platform/Chassis, 4x2	09.90 - 11.92	T 4.40	3100.90.03 3179.20.00 3132.30.00 5501.40.00	310 10 MFZ310 310GSB KZISZ - 3	- From model year: 01/1992		
			3500.90.42 3574.20.00 3587.30.00 8525.40.00	350 10 14" MF 350 350GSZ KZIS-3	- GBox: ZFS5-42		
			5501.40.00	KZISZ - 3	- From model year: 01/1992		
S 135.08/A,S 150.08/A 40AEA4	05.96 - 01.00	MIDR 04.02.26 A/41 MIDR 04.02.26 B/41	3100.90.03 3179.20.00 3132.30.00 5501.40.00	310 10 MFZ310 310GSB KZISZ - 3			
			3591.30.00	350 10 350WGTZ			
			5501.40.00	KZISZ - 3			
S 140.08/B JN1A14 S 140.09/B JN1E24, JN1E24A S 140.09/B JN1A18	01.90 - 09.93 01.90 - 09.93 01.90 - 09.93	MIDS 06.02.12 C	3100.90.01 3169.20.00 3113.30.00 6905.40.00	310 10 MF310 310GSBL KZIS - 3	- Engine code: MIDS060212C - GBox: ZF5-35/6-36		

Vehicle list

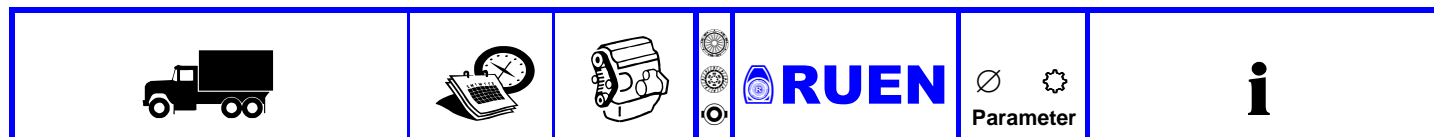

RENAULT TRUCKS

Midliner		09.83 - 01.00		
S 150.08/A,S 150.08/B JN1E24, JKSC13	01.94 - 05.96	798-10	3500.90.42	350 10 14" MF 350 350GSZ KZIS-3 - Engine code: MIDR060226U - Engine code: MIDS060212B - Engine code: MIDR060226V - GBox: ZFS5-42 - GBox: Eaton 4106B - GBox: ZFS5-35, ZFS6-36 - GBox: Eaton 4106A
S 150.08/B 40ACE1	11.92 - 01.94	MIDR 06.02.26 U	3574.20.00	
S 150.08/B JN1E24	01.94 - 05.96	MIDR 06.02.26 U/4	3587.30.00	
S 150.08TI, Dump Truck, 4x2	05.83 - 07.86	MIDR 06.02.26 V	8525.40.00	
S 150.08TI, Platform/Chassis, 4x2	05.83 - 07.86	MIDR 06.02.26 V/41		
S 150.08TI, Dump Truck, 4x2	05.86 - 09.90	MIDS 06.02.12 B		
S 150.08TI, Platform/Chassis, 4x2	05.86 - 09.90	MIDS 06.02.12 D/3		
S 150.08TI/R	05.86 - 09.90			
S 150.09/B 40ACE4	11.92 - 01.94			
S 150.09/B 40ACE5	11.92 - 01.94			
S 150.09/B JN1E24, Dump Truck, 4x2	01.94 - 05.96			
S 150.09/B JN1E24, Platform/Chassis, 4x2	01.94 - 05.96			
S 150.09/B 40ACE4	05.96 - 01.00			
S 150.09/B 40ACE5	05.96 - 01.00			
S 150.09TI, Dump Truck, 4x2	05.83 - 07.86			
S 150.09TI, Platform/Chassis, 4x2	05.83 - 07.86			
S 150.09TI, Dump Truck, 4x2	05.86 - 09.90			
S 150.09TI, Utility truck, 4x2	05.86 - 09.90			
S 150.09TI, 9.00t, 4x2	05.86 - 09.90			
S 150.09TI, 9.50t, 4x2	05.86 - 09.90			
S 150.11TI, Dump Truck, 4x2	05.86 - 09.90			
S 150.11TI, 11.50t, 4x2	05.86 - 09.90			
S 150.11TI, 10.00t, 4x2	05.86 - 09.90			
S 150.11TI, 11.00t, 4x2	05.86 - 09.90			
S 150.13TI	04.86 - 09.90			
S 150.13TI, Dump Truck, 4x2	05.86 - 09.90			
S 150.13TI, Platform/Chassis, 4x2	05.86 - 09.90			
S 150.14TI BOM	05.86 - 09.90			
S 160.08/A,S 160.08/B JKSC12, JN1A16	01.90 - 09.93			
S 160.08/B JN1A14	01.90 - 09.93			
S 160.09/B JN1E24, JN1E24A	01.90 - 09.93			
S 160.09/B JN1A12	01.90 - 09.93			
S 160.09/B SP JN1A12	01.90 - 09.93			
S 180.08/A 40ACE5, 40ACF4	11.92 - 10.96			
S 180.08/A 40ACF4	05.96 - 01.00			
S 180.08/A 40ACG1	05.96 - 01.00			
S 180.08/A,S 180.08/B 40ACE5, 40ACG1	11.92 - 10.96			
S 180.08/A,S 180.08/B 40ACE5, 40ACF3	11.92 - 10.96			
S 180.09/B 40ACE5, Dump Truck, 4x2	11.92 - 10.96			
S 180.09/B 40ACE4	11.92 - 10.96			
S 180.09/B 40ACE5, Platform/Chassis, 4x2	11.92 - 10.96			
S 180.09/B 40ACE1	11.92 - 10.96			
S 180.09/B 40ACE4	05.96 - 01.00			
S 180.09/B 40ACE5	05.96 - 01.00			
S 150.09/B,S 135.09/B 40AEB5, 40AEA3	05.96 - 01.00	MIDR 04.02.26 A/41	3591.30.00	350 10 350WGTZ KZISZ - 3 - Engine code: ZF S5-42, Eaton 4106A - Engine code: ZF S5-42, Eaton 4106A
		MIDR 04.02.26 B/41	5501.40.00	

Vehicle list

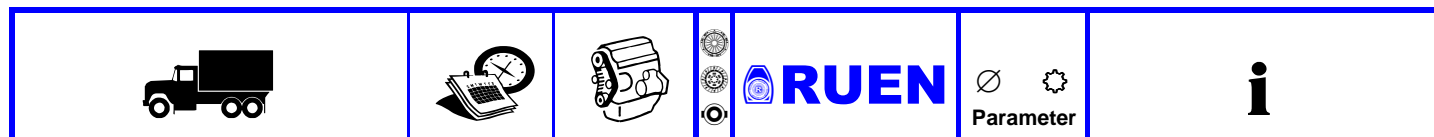

RENAULT TRUCKS

Midliner		09.83 - 01.00			
S 170.11TI	10.87 - 05.89	MIDR 06.02.12 D	3500.90.42 3574.20.00 3587.30.00 8525.40.00 8526.40.00	350 10 14" MF 350 350GSZ KZIS-3	- Engine code: MIDR060212 - GBox: ZFS5-35, ZFS6-65
S 170.11TI/R, 11.50t, Platform/Chassis	10.87 - 05.89				
S 170.11TI/R, 10.00t, Platform/Chassis	10.87 - 05.89				
S 170.13TI 4x4JS1A, 4x4JS1	10.83 - 03.93				
S 170.13TI,S 170 SP	10.83 - 03.93				
S 170.13TI,S 170.13TI/R	10.83 - 05.89				
S 170.13TI/T	10.84 - 05.89				
S 170.14TI, Dump Truck, 4x2	10.83 - 05.89				
S 170.14TI, Platform/Chassis, 4x2	10.83 - 05.89				
S 170.14TI/R	10.87 - 05.89				
S 170.15TI 4x4JS2	10.82 - 09.93				- Engine code: MIDR060212 - GBox: BDSL
M 230.12/C 40ACC5	05.92 - 10.96	MIDR 06.02.26 D	3863.20.00	380 GM380	
M 230.12/D	05.89 - 07.92	MIDR 06.02.26 S			
M 230.12/D 40ACD5	05.89 - 07.92	MIDR 06.02.26 X			
M 230.13/C 40ACA2	05.92 - 10.96				
M 230.13/C,M 230.13/D 40ACA2	05.89 - 10.96				
M 230.13/D	05.89 - 07.92				
M 230.13C/T 40GCC2	05.89 - 10.96				
M 230.15/D 40ACD7, Platform/Chassis, 4x2	05.89 - 10.96				
M 230.16/D 40ACD3, 40ACB3, Dump Truck, 4x2	05.89 - 10.96				
M 230.16/D 40ACD3, 40ACB3, Platform/Chassis, 4x2	05.89 - 10.96				
M 230.16/D CIT	05.89 - 07.92				
M 230.16D/T	05.89 - 10.96				
Midlum		01.00 -			
135.08/B,150.08/B, Dump Truck, 4x2	01.00 -	MIDR 04.02.26 A/4	3100.90.03 3179.20.00 3132.30.00 5501.40.00	310 10 MFZ310 310GSB KZISZ - 3	- For: Midlum 135
135.08/B,150.08/B, Platform/Chassis, 4x2	01.00 -	MIDR 04.02.26 B/4			
135.09/B,150.09/B	01.00 -				
135.10/B,150.10/B, Dump Truck, 4x2	01.00 -				
135.10/B,150.10/B, Platform/Chassis, 4x2	01.00 -				
150.08/B 42B300100005	10.01 -	dCi 4B	3950.90.32 3961.20.00 3973.30.00 8544.40.00 3620.90.28 3620.20.00 3617.30.00 8525.40.00	395 10 MF395 395WGTZ	- GBox: Eaton 9-Gang/shift
150.10/B 42B301100007	10.01 -	dCi 4C			
150.12/B 42B302100003	01.00 -	dci 6W			
180.08/B 42B300100015	10.01 -	MIDR 04.02.26 B/4			
180.10/B 42B300100015	10.01 -	MIDR 06.02.26 W/4			
180.12/B, 180.12/C 42B302100007, 44C100100005	10.01 -				
210.08/B, 220.08/B 42B404100005	01.00 -				
210.10/B, 220.10/B 42B405100007	01.00 -				
220.12 47XC01100005	10.01 -				
220.14 47XC01300009, 47XA00100008	10.01 -				
220.16 47XC01700013	10.01 -				- GBox: ZF 5S-42, Eaton 4106A/B - GBox: ZF 5S-42, Eaton 4106 OD/5206A - GBox: ZF 5S-42 - GBox: ZF 5S-42, Eaton 5206A

Vehicle list

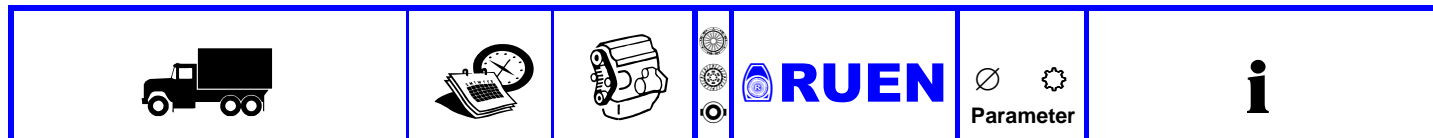

RENAULT TRUCKS

Midlum

01.00 -

160.08 44EL01000003	05.06 -	DXi 5		3620.90.29	362 10	
160.10 44EL01000009	05.06 -			3620.20.00	MF362	
160.12 44EL01000011	05.06 -			3619.30.00	362WGTZ	
190.08 44EL01000013	05.06 -			8543.40.00	KZIS-4	
190.10 44EL01000019	05.06 -					
190.12 44ML03000005	05.06 -					
190.12 44EL01000021, 44ML01000003	05.06 -					
190.13 44MA01000103	05.06 -					
190.14 44MA01000105	05.06 -					
190.16 44MA01000109	05.06 -					
220.08 44EL01000023	05.06 -					
220.10 44EL01000029	05.06 -					
220.12 44EL01000031, 44ML01000013, 44LA01000022	05.06 -					
220.13 44LA01000026, 44MA01000213	05.06 -					
220.14 44MA01000215, 44LA01000030	05.06 -					
220.16 44LA01000038, 44MA01000219	05.06 -					
180.12 44V 03400007	10.01 -	dCi 4C		3620.90.28	362 10	- GBox: ZF 5S-42, Eaton 5206A
210.08/B	01.00 -	dci 6A		3620.20.00	MF362	- GBox: ZF 5S-42, Eaton 4106 OD/5206A
210.09/B	01.00 -	dci 6W		3617.30.00	362WGTZ	- GBox: ZF 5S-42
210.10/B	01.00 -	MIDR 06.02.26 W/4		8525.40.00	KZIS-3	
210.12/C	01.00 -					
210.12/C, 220.12/C 44C100500005	01.00 -					
210.13/C	01.00 -					
210.13/C, 220.13/C, 220.13/D	01.00 -					
44C201500010, 45D201500205, 45D201500007	01.00 -					
210.14/C, 220.14/C, 220.14/D	01.00 -					
44C201500014, 45D201500209	01.00 -					
210.15/C, Dump Truck, 4x2	01.00 -					
210.15/C, Platform/Chassis, 4x2	01.00 -					
210.16/C, 220.16/C, 22.16/D	01.00 -					
44C202500006, 45D202500207	01.00 -					
220.15 44V 03800005	10.01 -					
220.18/D 45D303100012	10.01 -					
270.12/C 44C201500022, 44C201500026	10.01 -					
270.13/C, 270.13/D 45D201500221, 44C201500030, 44C201500034	10.01 -					
270.14/C, 270.14/D 44C201500042, 44C201500038, 45D201500229	10.01 -					
270.16/C 44T 04100004	10.01 -					
270.16/C, 270.16/D 44C202500022, 45D202500229, 44C202500012	10.01 -					
270.18/D 45D303100032, 45D303100022	10.01 -					
240.12 44LB01000002	05.06 -	DXi 7		3950.90.20	10	- GBox: ZF 9S1110TO, ZF 6S1000TO, ZF 6S8500D
240.13 44LB01000006, 44MB01000103	05.06 -			3961.20.00	MF395	
240.14 44LB01000010, 44MB01000105	05.06 -			3973.30.00	395WGTZ	
240.15 44LB03000005	05.06 -			8543.40.00	KZIS-4	
240.16 44MB01000109, 44LB01000018	05.06 -					
240.18 44HB01000010	05.06 -					
280.12 44LB01000022	05.06 -					
280.13 44MB01000213, 44LB01000026	05.06 -					
280.14 44MB01000215, 44LB01000030	05.06 -					
280.16 44MB01000219, 44LB01000038	05.06 -					
280.18 44HB01000020	05.06 -					

Vehicle list



RENAULT TRUCKS

series PR

10 S (6G.)	12.78 -			3866.20.00	380 GM380K	- GBox: BDSL
12 S (6G.) 14 S	02.78 - 01.76 -			3866.20.00	380 GM380K	- GBox: BDSL
14				3866.20.00	380 GM380K	- GBox: BDSL
8	01.86 -			3574.20.00	350 14" MF 350	

Premium 04.96 -

Distribution 210.16 22ACA4	04.96 -	MIDR 06.02.26 W/4		3950.90.12 3957.20.00 3962.30.00 8535.40.00	395 10 MFZ395 395GTZ KZIZ - 4,5	- GBox: Eaton 8209 A
Distribution 210.18D, 220.18 22ACA3, 22AB01100031, 22AB01100001, 22AB01100051	04.96 -	dci 6W MIDR 06.02.26 W/4		3950.90.12 3957.20.00 3962.30.00 8535.40.00	395 10 MFZ395 395GTZ KZIZ - 4,5	- For: Premium 210
Distribution 250.16 22ACA4 Distribution 250.18D 22ACA3 Distribution 250.19 22ACA1	04.96 - 04.96 - 04.96 -	MIDR 06.02.26 Y/41		3950.90.12 3957.20.00 3962.30.00 8535.40.00	395 10 MFZ395 395GTZ KZIZ - 4,5	- GBox: Eaton 8209 A
Distribution 260.16 22AXA4 Distribution 260.18 22AXA3 Distribution 260.19 22AXA1	04.96 - 04.96 - 04.96 -	MIDR 06.20.45 C/4		4300.90.60 4311.20.00 4312.30.00 8937.40.00	430 10 MFZ430 430W2GTZ KZISZ-5	- GBox: Eaton 8209 A
Distribution 300.16D 22AXA4 Distribution 300.16T 22GXA4 Distribution 300.18D 22AXA3 Distribution 300.18D/T Distribution 300.19 22AXA1 Distribution 300.19D/T 22GXA1 Distribution 300.26D 22CXA1, 22SXA1 Route 300.16 Route 300.18 Route 300.18T Route 300.19 Route 300.19T 22GXA1	04.96 - 04.96 - 04.96 - 04.96 - 04.96 - 04.96 - 04.96 - 09.96 - 09.96 - 09.96 - 09.96 - 09.96 - 09.96 -	MIDR 06.20.45 D/41		4300.90.61 ⊕ 4311.20.00 4311.30.00 8937.40.00	430 20 MFZ430 430W2GTZ KZISZ-5	- GBox: B9
				4300.90.40 4311.20.00 4311.30.00 8937.40.00	430 20 MFZ430 430W2GTZ KZISZ - 5	- GBox: B9+35mm,B18
				4000.90.07 4026.10.00 4027.30.00 8937.40.00	400 20 MFZ2/400X 400WGVZ KZISZ-5	- Vehicles with double disc clutch
				4300.90.60 4311.20.00 4312.30.00 8937.40.00	430 10 MFZ430 430W2GTZ KZISZ-5	- GBox: ZF 9S-109
Distribution 320.18 22CC06100025 Distribution 320.18 D 22AA06100005, 22AA06100035, 22AA06100055, 22AA06100125 Distribution 320.24D 22QQ06100055 Distribution 320.26D 22QQ06100005, 22EE06100005, 22QQ06100035, 22QQ06100015, 22HA06300003 Route 320.18 22AA07100051, 22AA07100001, 22AA07100031 Route 320.18 22CC07100004	08.00 - 08.00 - 08.00 - 08.00 - 08.00 - 08.00 - 08.00 -	dCi 11G		4300.90.60 4311.20.00 4312.30.00 8937.40.00	430 10 MFZ430 430W2GTZ KZISZ-5	- GBox: ZF 9S-109
				4300.90.17 4311.20.00 4346.30.00 8919.40.00	430 10 MFZ430 430WGTZ KZISZ - 5	
				4000.90.12 4026.10.00 4029.30.00 8941.40.00	400 10 MFZ2/400X 400GTZ KZISZ-5	- GBox: ZF 12AS2301

Vehicle list

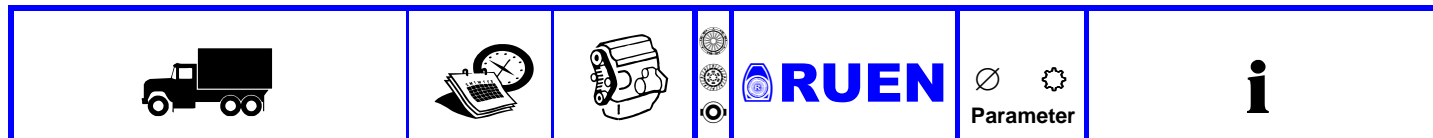

RENAULT TRUCKS

Premium

04.96 -

Distribution 340.18D 22AXA3	04.96 -	MIDR 06.20.45 E/41		4300.90.61 ⊕	430 20	- GBox: B9
Distribution 340.18D/T	04.96 -			4311.20.00	MFZ430	
Distribution 340.19D 22AXA1	04.96 -			4311.30.00	430W2GTZ	
Distribution 340.19D/T 22GXA1	04.96 -			8937.40.00	KZISZ-5	
Distribution 340.26D 22CXA1, 22SXA1	04.96 -			4300.90.40	430 20	- GBox: B18,B9+35mm
				4311.20.00	MFZ430	
				4311.30.00	430W2GTZ	
				8932.40.00	KZISZ - 5	
				4000.90.07	400 20	- GBox: B18,B9+35mm
				4026.10.00	MFZ2/400X	
				4027.30.00	400WGVZ	
				8937.40.00	KZISZ-5	
				4300.90.60	430 10	- GBox: ZF 9S-109
				4311.20.00	MFZ430	
				4312.30.00	430W2GTZ	
				8937.40.00	KZISZ-5	
				4300.90.41	430 10	- From model year: 09.1999
				4311.20.00	MFZ430	
				4306.30.00	430WGTZ	
				8933.40.00	KZISZ - 5	
				4000.90.12	400 10	- GBox: ZF 8S-151
				4026.10.00	MFZ2/400X	
				4029.30.00	400GTZ	
				8941.40.00	KZISZ-5	
Distribution 370.18 22CC06100027, 22CC06100131	08.00 -	dCi 11 B/43		4311.20.00	430	- GBox: ZF 8S-151
Distribution 370.18D 22AA06100127, 22AA06100057, 22AA06100007, 22AA06100037	08.00 -	dCi 11C			MFZ430	- GBox: ZF 16S-151
Distribution 370.24D 22QQ06100057	08.00 -	dCi 11E				- GBox: ZF 16S-181
Distribution 370.26D 22QQ06100007, 22QQ06100017, 22EE06100007, 22QQ06100037	08.00 -			8933.40.00	KZISZ - 5	- GBox: ZF 12AS 2301
Route 370.18 22AA07100003, 22AA07100033, 22AA07100053	08.00 -					- GBox: ZF 12AS "Full Auto"
Route 370.18 22CC07100065, 22CC07100054, 22CC07100055, 22CC07100064	08.00 -			4000.90.12	400 10	- Vehicles with double disc clutch
Route 370.24 22QQ07100053	08.00 -			4026.10.00	MFZ2/400X	
Route 370.26 22QQ07100033, 22QQ07100063	08.00 -			4029.30.00	400GTZ	
Route 420.18 22AA07100055, 22AA07100005, 22AA07100535, 22AA07100035, 22AA07100555, 22AA07100505	08.00 -			8941.40.00	KZISZ-5	
Route 420.18T 22CC07100108, 22CC07100509, 22CC07100105, 22CC07100114, 22CC07100508, 22CC07100515, 22CC07100514, 22CC07100104	08.00 -					
Route 420.24 22QQ07100555, 22QQ07100055	08.00 -					
Route 420.24 22RR07100503, 22RR07100103	08.00 -					
Route 420.25 22JJ07100501, 22JJ07100101	08.00 -					
Route 420.26 22QQ07100065, 22QQ07100015, 22QQ07100565, 22QQ07100505, 22QQ07100535, 22QQ07100005, 22QQ07100035	08.00 -					

Vehicle list



RENAULT TRUCKS

Premium		04.96 -			
Distribution 400.18D Distribution 400.18D/T	01.00 -	MIDR 06.23.56 B/41	4300.90.23 ⊕ 4383.60.00 4380.30.00	430 10 MFZ430 430WGTZ	- GBox: B9
	01.00 -		4300.90.40 4311.20.00 4311.30.00 8932.40.00	430 20 MFZ430 430W2GTZ KZISZ - 5	- GBox: B18
			4000.90.07 4026.10.00 4027.30.00 8937.40.00	400 20 MFZ2/400X 400WGVZ KZISZ-5	- GBox: B9,B18
			4300.90.39 4311.20.00 4313.30.00 8933.40.00	430 10 MFZ430 430WGTZ KZISZ - 5	- GBox: ZF 8S-151
			4000.90.12 4026.10.00 4029.30.00 8941.40.00	400 10 MFZ2/400X 400GTZ KZISZ-5	- GBox: ZF 8S-151
Distribution 420.18 Distribution 420.18D	08.00 -	dCi 11C	4300.90.39 4311.20.00 4313.30.00 8933.40.00	430 10 MFZ430 430WGTZ KZISZ - 5	- GBox: ZF 8S-151
	08.00 -		4300.90.17 4311.20.00 4346.30.00 8919.40.00	430 10 MFZ430 430WGTZ KZISZ - 5	- GBox: ZF 12AS "Full Auto"
			4000.90.12 4026.10.00 4029.30.00 8941.40.00	400 10 MFZ2/400X 400GTZ KZISZ-5	- Vehicles with double disc clutch
Route 340.18 22AXA1 Route 340.18T 22GXA3 Route 340.19 22AXA1 Route 340.19T 22GXA1 Route 340.24 Route 340.26 22CXA1	04.96 -	MIDR 06.20.45 E/41	4300.90.61 ⊕ 4311.20.00 4311.30.00 8937.40.00	430 20 MFZ430 430W2GTZ KZISZ-5	- Engine code: B9
	04.96 -		4300.90.23 ⊕ 4383.60.00 4380.30.00	430 10 MFZ430 430WGTZ	- GBox: B9
	04.96 -		4300.90.40 4311.20.00 4311.30.00 8932.40.00	430 20 MFZ430 430W2GTZ KZISZ - 5	- GBox: B9+35mm,B18
	04.96 -		4000.90.07 4026.10.00 4027.30.00 8937.40.00	400 20 MFZ2/400X 400WGVZ KZISZ-5	- GBox: B9+35mm,B18
	04.96 -		4300.90.41 4311.20.00 4306.30.00 8933.40.00	430 10 MFZ430 430WGTZ KZISZ - 5	- GBox: ZF 8S-151
	04.96 -		4000.90.12 4026.10.00 4029.30.00 8941.40.00	400 10 MFZ2/400X 400GTZ KZISZ-5	- GBox: ZF 8S-151

Vehicle list

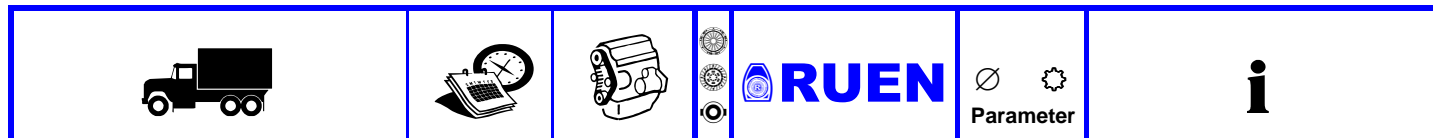

RENAULT TRUCKS

Premium

04.96 -

Route 385.18,400.18 2GVA2	04.96 -	MIDR 06.23.56 A/41 MIDR 06.23.56 B/41	4300.90.61 ⊕	430 20	- GBox: B9
Route 385.18T,400.18T 22GVA3	04.96 -		4311.20.00	MFZ430	
Route 385.19,400.19 22AVA1	04.96 -		4311.30.00	430W2GTZ	
Route 385.19T,400.19T 22GVA1	04.96 -		8937.40.00	KZISZ-5	
Route 385.24,400.24	04.96 -		4300.90.40	430 20	- GBox: B9+35mm,B18
Route 385.24T,400.24T 22JVA1A	04.96 -		4311.20.00	MFZ430	
Route 385.26	04.96 -		4311.30.00	430W2GTZ	
Route 385.26,400.26 22CVA1	04.96 -	8932.40.00	KZISZ - 5		
		4000.90.07	400 20	- GBox: B9+35mm,B18	
		4026.10.00	MFZ2/400X		
		4027.30.00	400WGVZ		
		8937.40.00	KZISZ-5		
		4300.90.39	430 10	- GBox: ZF 8S-151	
		4311.20.00	MFZ430		
		4313.30.00	430WGTZ		
		8933.40.00	KZISZ - 5		
		4000.90.12	400 10	- GBox: ZF 8S-151	
		4026.10.00	MFZ2/400X		
		4029.30.00	400GTZ		
		8941.40.00	KZISZ-5		
Distribution 260 BOM	06.96 -		4300.90.60	430 10	- Engine code: MIDR062045C/4 - GBox: Eaton 8209 A, ZF 9S-109, ZF 16S-109
			4311.20.00	MFZ430	
			4312.30.00	430W2GTZ	
			8937.40.00	KZISZ-5	
Distribution 300 BOM	06.96 -		4300.90.61 ⊕	430 20	- GBox: B9
			4311.20.00	MFZ430	
			4311.30.00	430W2GTZ	
			8937.40.00	KZISZ-5	
			4300.90.40	430 20	- GBox: B9+35mm,B18, B9 TBV
			4311.20.00	MFZ430	
			4311.30.00	430W2GTZ	
			8932.40.00	KZISZ - 5	
			4000.90.07	400 20	- GBox: B9+35mm,B18 - Vehicles with double disc clutch
			4026.10.00	MFZ2/400X	
			4027.30.00	400WGVZ	
			8937.40.00	KZISZ-5	
			4300.90.60	430 10	- GBox: ZF 9S-109, ZF 16S-109, Eaton 8209 A
			4311.20.00	MFZ430	
			4312.30.00	430W2GTZ	
			8937.40.00	KZISZ-5	

Premium 2

10.05 -

370		DXi 7	4329.30.00	430 24	- GBox: AT2412C/ATO2512C
410			8641.47.00	430WGTZ.	- GBox: AT2412D
			8641.47.00	PHIS-6/38	- GBox: AT2412C/ATO2512C - GBox: AT2412D
450		DXi 7	4329.30.00	430 24	- GBox: AT2412D
			4398.30.00	430WGTZ.	- GBox: AT2412C/ATO2512C
			8641.47.00	PHIS-6/38	- GBox: AT2412C/ATO2512C - GBox: AT2412D

Vehicle list

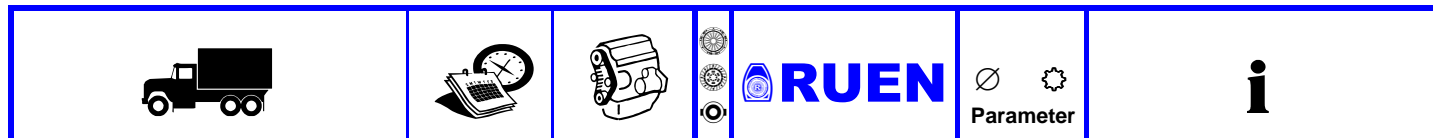

RENAULT TRUCKS

Premium 2

10.05 -

Distribution 240.18 D 29SB06700012	05.06 -	DXi 7		3950.90.20	10	- GBox: ZF 9S1110TO, ZF 6S1000TO	
Distribution 270.19 29SB06705011	10.06 -			3961.20.00 3973.30.00 8543.40.00	MF395 395WGTZ KZIS-4		
Distribution 280.18 D 29SB06700014	10.05 -						
Distribution 280.26 29RB06700074	10.05 -						
Distribution 310.18 29SB06705012	10.06 -				4329.30.00	430 24 430WGTZ.	- GBox: AT2412D
Distribution 310.26 29RB06705002	10.06 -						
Distribution 320.18 D 29SB06700016	10.05 -				8641.47.00	PHIS-6/38	- GBox: AT2412D
Distribution 320.26 29RB06700006	10.05 -						
Distribution 340.18 29SB06705013	10.06 -						
Distribution 340.26 29RB06705003	10.06 -						
Lander 270.18, Lander 270.19 29AB06700201, 29AB06700202	10.06 -						
Lander 310.19 29AB06700202	10.06 -						
Lander 310.26 29CB06700202	10.06 -						
Lander 340.18, Lander 340.19 29AB06700203	10.06 -						
Lander 340.26 29CB06700203	10.06 -						
Distribution 320.18 29TB06700026	05.06 -	DXi 7		4329.30.00	430 24 430WGTZ.	- GBox: AT2412D	
Distribution 340.19 29TB06705023	10.06 -						
Lander 310.26 29NB06700202	10.06 -				8641.47.00	PHIS-6/38	- GBox: AT2412D
Lander 340.26 29NB06700403	10.06 -						
Distribution 370.18 D 24SF06100013	10.05 -	DXi 11		4300.90.91	430 10	- GBox: 16S-2220	
Distribution 370.18 D 24TF06100003	10.05 -			4311.20.00 4346.30.00 8933.40.00	MFZ430 430WGTZ KZISZ - 5		
Distribution 370.26 24RF06100003, 24RF06100013	10.05 -						
					4000.90.12	400 10	- Vehicles with double disc clutch
					4026.10.00 4029.30.00 8941.40.00	MFZ2/400X 400GTZ KZISZ-5	
					4329.30.00	430 24 430WGTZ.	- GBox: AT2412
					8641.47.00	PHIS-6/38	- GBox: AT2412
Distribution 380.18 24SF06105014	10.06 -	DXi 11		4300.90.91	430 10	- GBox: 16S-2220	
Distribution 380.19 24TF06105024	10.06 -			4311.20.00 4346.30.00 8933.40.00	MFZ430 430WGTZ KZISZ - 5		
Distribution 380.26 24RF06105004	10.06 -						
Lander 380.19 24AF06100204	10.06 -				4000.90.12	400 10	- Vehicles with double disc clutch
Lander 380.19 24BF06100204	10.06 -				4026.10.00 4029.30.00 8941.40.00	MFZ2/400X 400GTZ KZISZ-5	
Lander 380.26	10.06 -						
Lander 380.26 24NF06100204	10.06 -						
Lander 380.32 24LF07100204	10.06 -						
Route 380.18 24SF07100004	10.06 -				4329.30.00	430 24 430WGTZ.	- GBox: AT2412
Route 380.19 24TF07100004	10.06 -						
Route 380.26 24RF07100004	10.06 -				8641.47.00	PHIS-6/38	- GBox: AT2412
					4300.90.98	430 10	- GBox: 16S1930
					4311.20.00 4346.30.00 8949.40.00	MFZ430 430WGTZ	

Vehicle list



RENAULT TRUCKS

Premium 2

10.05 -

Distribution 410.18 D 24SF06100015	10.05 -	DXi 11		4300.90.91	430 10	- GBox: 16S-2220
Distribution 410.18 D 24TF06100005	10.05 -			4311.20.00	MFZ430	
Distribution 410.26 24RF06100005	10.05 -			4346.30.00	430WGTZ	
Route 330.18 T 27TC07100023	10.05 -			8933.40.00	KZISZ - 5	
Route 410.18 24TF07100035, 24TF07100015, 24TF06100005, 24TF07100025	10.05 -			4000.90.12	400 10	- Vehicles with double disc clutch
Route 410.24 24RF07100025	10.05 -			4026.10.00	MFZ2/400X	
Route 410.25 24RF07100035	10.05 -			4029.30.00	400GTZ	
Route 410.25 24JF07100005	10.05 -			8941.40.00	KZISZ-5	
Route 410.26 24RF07100005	10.05 -			4329.30.00	430 24	- GBox: AT2412
				8641.47.00	PHIS-6/38	- GBox: AT2412
Distribution 430.18 24SF06105016	10.06 -	DXi 11		4300.90.91	430 10	- GBox: 16S-2220
Distribution 430.19 24TF06105026	10.06 -			4311.20.00	MFZ430	
Distribution 430.26 24RF06105006	10.06 -			4346.30.00	430WGTZ	
Distribution 460.19 24SF06105098	10.06 -			8933.40.00	KZISZ - 5	
Distribution 460.19 24TF06105098	10.06 -			4000.90.12	400 10	- Vehicles with double disc clutch
Lander 430.32 24LF07100206	10.06 -			4026.10.00	MFZ2/400X	
Lander 460.18 24AF07100208	10.06 -			4029.30.00	400GTZ	
Lander 460.18 24BF07100208	10.06 -			8941.40.00	KZISZ-5	
Lander 460.26 24CF07100208	10.06 -			4398.30.00	430 24	- GBox: AT 2412 C/ATO
Lander 460.26 24NF07100208	10.06 -			8641.47.00	PHIS-6/38	- GBox: AT 2412 C/ATO
Lander 460.26 24DF07100208	10.06 -	DXi 11		4300.90.116	430 10	- GBox: 16S-2230
Lander 460.32 24LF07100208	10.06 -			4395.20.00	MFZ430	
Route 430.18 24SF07100006	10.06 -			4399.30.00	430WGTZ	
Route 430.19 24TF07100006	10.06 -			8949.40.00		
Route 430.26 24RF07100006	10.06 -					
Route 430.26 24JF07100006	10.06 -					
Route 460.18 24SF07100008	10.06 -					
Route 460.18 24TF07100008	10.06 -					
Route 460.26 24RF07100008	10.06 -					
Route 460.26 24JF07100008	10.06 -					
Distribution 450.18 D 24SF06100127	10.05 -	DXi 11		4300.90.91	430 10	- Engine code: 16S-2220
Lander 440.18	10.05 -			4311.20.00	MFZ430	
Lander 440.19	10.05 -			4346.30.00	430WGTZ	
Lander 440.26	10.05 -			8933.40.00	KZISZ - 5	
Lander 440.32	10.05 -			4000.90.12	400 10	- Vehicles with double disc clutch
Route 410.18 D 24SF07100005, 24SF07100025	10.05 -			4026.10.00	MFZ2/400X	
Route 450.18 24TF07100007, 24TF07100017, 24TF07100037, 24RF07100027	10.05 -			4029.30.00	400GTZ	
Route 450.18 D 24SF07100027, 24SF07100007	10.05 -			8941.40.00	KZISZ-5	
Route 450.24 24RF07100027	10.05 -			4398.30.00	430 24	- GBox: AT 2412 C/ATO
Route 450.25 24RF07100037	10.05 -			8641.47.00	PHIS-6/38	- Engine code: AT 2412 C/ATO
Route 450.25 24JF07100005	10.05 -					
Route 450.26 24RF07100007, 24RF07100037	10.05 -					

Vehicle list

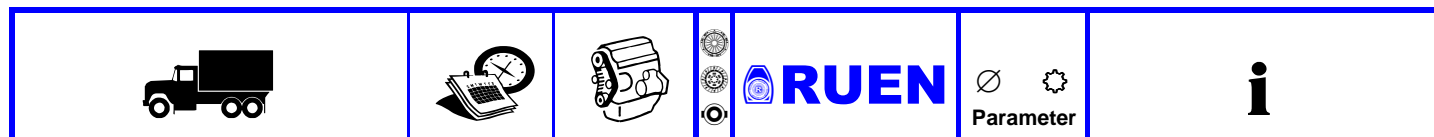

RENAULT TRUCKS

Premium 2 10.05 -

Lander 430.18 24AF06100206	10.06 -	DXi 11		4300.90.91	430 10	- GBox: 16S-2220
Lander 430.18 24BF06100206	10.06 -			4311.20.00	MFZ430	
Lander 430.26 24CF06100206	10.06 -			4346.30.00	430WGTZ	
Lander 430.26 24NF06100206	10.06 -			8933.40.00	KZISZ - 5	
Lander 430.26 24DF07100206	10.06 -			4000.90.12	400 10	- Vehicles with double disc clutch
				4026.10.00	MFZ2/400X	
				4029.30.00	400GTZ	
				8941.40.00	KZISZ-5	
				4329.30.00	430 24	- GBox: AT2412
					430WGTZ.	
				8641.47.00	PHIS-6/38	- GBox: AT2412
				4300.90.116	430 10	- GBox: 16S-2230
				4395.20.00	MFZ430	
				4399.30.00	430WGTZ	
				8949.40.00		

R 10.80 - 12.96

R 310.16	10.80 - 03.89	MIDR 06.35.40 C		4311.30.00	430 20	
R 310.16/T	10.80 - 03.89				430W2GTZ	
R 310.17	10.80 - 03.89			8936.40.00	KZISZ - 5	
R 310.17/T	10.80 - 03.89			4343.30.00	430 10	- GBox: Fuller
R 310.19	10.80 - 03.89				430GTZ	- To model year: 03/1986
R 310.19/T	10.80 - 03.89					
R 310.22, Platform/Chassis, 6x2	10.80 - 03.89					
R 310.22, Platform/Chassis, 6x4	10.80 - 03.89					
R 310.22/T	10.80 - 03.89					
R 330.17	05.88 - 05.91	MIDR 06.20.45 E		4311.30.00	430 20	
R 330.17/T	05.88 - 05.91				430W2GTZ	
R 330.19	05.88 - 05.91			8936.40.00	KZISZ - 5	
R 330.19/T	05.88 - 05.91					
R 330.24	05.88 - 05.91					
R 340.17	03.86 - 01.90	MIDR 06.35.40 G		4311.30.00	430 20	
R 340.17/T	03.86 - 01.90				430W2GTZ	
R 340.19	03.86 - 01.90			8936.40.00	KZISZ - 5	
R 340.19/T	03.86 - 01.90			4343.30.00	430 10	
R 340.24, Platform/Chassis, 6x2	03.86 - 01.90				430GTZ	
R 340.24, Platform/Chassis, 6x4	03.86 - 01.90					
R 340ti.16/T RG08A1X	01.90 - 05.91	MIDR 06.20.45 E		4311.30.00	430 20	
R 340ti.17 RA08A1	01.90 - 05.91				430W2GTZ	
R 340ti.18 RA08A1, RA08A1E, Dump Truck, 4x2	01.90 - 05.91			8936.40.00	KZISZ - 5	
R 340ti.18 RA08A1, RA08A1E, Platform/Chassis, 4x2	01.90 - 05.91			4343.30.00	430 10	
R 340ti.18	01.90 - 05.91				430GTZ	
R 340ti.18/T RG08A1, RG08A1E	01.90 - 05.91					
R 340ti.19	01.90 - 05.91					
R 340ti.19/T	01.90 - 05.91					
R 340ti.24 RC08E1	01.90 - 05.91					
R 340ti.26 RC08C1	01.90 - 05.91					







Vehicle list





























RENAULT TRUCKS

R 10.80 - 12.96						
R 350.17, 17.00t, Platform/Chassis	01.90 - 05.91	MIDR 06.35.40		4311.30.00	430 20	430W2GTZ
R 350.17, 17.50t, Platform/Chassis	01.90 - 05.91	G				
R 350.17/T	01.90 - 05.91	MIDR 06.35.40		8936.40.00	KZISZ - 5	
R 350.18, Dump Truck, 4x2	01.90 - 05.91	H		4343.30.00	430 10	430GTZ
R 350.18, 18.00t, 4x2	01.90 - 05.91					
R 350.18, 18.50t, 4x2	01.90 - 05.91					
R 350.18/T	01.90 - 05.91					
R 350.19	01.90 - 05.91					
R 350.19/T	01.90 - 05.91					
R 350.19/TB	01.90 - 05.91					
R 350.24	01.90 - 05.91					
R 350.26	01.90 - 05.91					
R 365.17	10.87 - 05.90					
R 365.17/T	10.87 - 05.90					
R 365.19	10.87 - 02.90					
R 365.19/T	10.87 - 02.90					
R 365.24, Platform/Chassis, 6x2	10.87 - 05.90					
R 365.24, Platform/Chassis, 6x4	10.87 - 05.90					
R 370.16	10.83 - 07.85	MIVS 08.35.30		4311.30.00	430 20	430W2GTZ
R 370.16/T	10.83 - 07.85	F				
R 370.22/T	10.83 - 07.85			8936.40.00	KZISZ - 5	
				4343.30.00	430 10	430GTZ
R 380.17	01.90 - 05.91	MIDR 06.35.40		4311.30.00	430 20	430W2GTZ
R 380.18, Dump Truck, 4x2	01.90 - 05.91	H				
R 380.18, 18.00t, 4x2	01.90 - 05.91			8936.40.00	KZISZ - 5	
R 380.18, 18.50t, 4x2	01.90 - 05.91			4343.30.00	430 10	430GTZ
R 380.18/T	01.90 - 05.91					
R 380.19	01.90 - 05.91					
R 380.19/T	01.90 - 05.91					
R 380.19/TB	01.90 - 05.91					
R 380.22/T	01.90 - 05.91					
R 380.24	01.90 - 05.91					
R 380.25, Dump Truck, 6x4	01.90 - 05.91					
R 380.25, Platform/Chassis, 6x4	01.90 - 05.91					
R 380.25/T	01.90 - 05.91					
R 380.26	01.90 - 05.91					
R 380.26/T	01.90 - 05.91					
R 390.16	07.85 - 03.89	MIVR 08.35.30		4311.30.00	430 20	430W2GTZ
R 390.16/T	07.85 - 03.89	C				
R 390.17	07.85 - 03.89			8936.40.00	KZISZ - 5	
R 390.17/T	07.85 - 03.89			4343.30.00	430 10	430GTZ
R 390.22/T	07.85 - 03.89					
R 390.24	07.85 - 03.89					
R 390.24/T	07.85 - 03.89					
R 420.17	10.88 - 10.91	MIVR 08.35.30		4311.30.00	430 20	430W2GTZ
R 420.17/T	10.88 - 10.91	G				
R 420.19	10.88 - 10.91	MIVR 08.35.30		8936.40.00	KZISZ - 5	
R 420.19/T	10.88 - 10.91	H		4343.30.00	430 10	430GTZ
R 420.24	10.88 - 10.91					
R 420.24/T	10.88 - 10.91					
R 420.35/T	10.88 - 10.91					

Vehicle list

					
---	---	---	--	---	---

RENAULT TRUCKS

R		10.80 - 12.96				
R 370.19/T	10.83 - 07.85	MIVR 08.35.30		4311.30.00	430 20 430W2GTZ	- Engine code: MIVS083530 - GBox: B9/B18
R 370.26/T	10.83 - 07.85	C				
R 390.19/T	07.85 - 03.89	MIVS 08.35.30 F		8936.40.00	KZISZ - 5	- Engine code: MIVS083530 - GBox: B9/B18
				4343.30.00	430 10 430GTZ	- Engine code: MIVS083530 - GBox: Fuller
S						
90		Perkins T4-38		2822.20.00	280 MF280	
series S						
45				3562.20.00	350 GMF350	- From chassis no.: 365->
				3570.30.00	350 10 350Z	- From chassis no.: 365->
53				3562.20.00	350 GMF350	- From chassis no.: 1512->
				3570.30.00	350 10 350Z	- From chassis no.: 1512->
105	10.92 -			3562.20.00	350 GMF350	- GBox: RVI332
				3570.30.00	350 10 350Z	- GBox: RVI332
90 SB 2 LE SB 2 MBD	05.83 - 10.70 - 12.79 - 12.79			2525.20.00	250 MF250	- Engine code: 720 - GBox: ZFS5-24, 321 - GBox: 321
series SAVIEM						
12. 215 19. 215 22. 215				3861.30.00	380 10 380W2GSZ	
				3812.30.00	380 10 380GSZ	
				7951.40.00	KZIS - 4	
12. 230 19. 230 22. 230 32. 230				3861.30.00	380 10 380W2GSZ	
				3812.30.00	380 10 380GSZ	
				7951.40.00	KZIS - 4	
13. 168, HAB 15. 168, HAB 4x4 19. 192 H 17, 18, 19 B 19. 192 HA 17, 18, 19 B 19. 268	01.78 - 12.81 01.78 - 12.81 01.78 - 12.81 01.78 - 12.81 01.78 - 12.81			3563.20.00	350 GMF350	
				3565.20.00	350 GMF350	
				3510.30.00	350 10 350W2GSZ	
				3575.30.00	350 10 350WGSZ	
				8533.40.00	KZI - 4,5	
19. 240 H, HB, HAB, HA TB 26. 240 DHB 6x4 32. 240 DHB, DHAB, DHRB	01.74 - 12.81 01.75 - 12.81 01.75 - 12.81			3835.20.00	380 GF380	
				3806.30.00	380 10 380W2GSZ	
				7951.40.00	KZIS - 4	
series SG						
2 SG 2 3 SG 3 SG 5 SG 5 D	01.69 - 01.79 02.79 - 01.74 - 01.79 02.79 - 01.74 - 12.79 01.69 - 12.79			2525.20.00	250 MF250	- Engine code: 712, 817 - GBox: 321 - GBox: ZFS5-24

Vehicle list



RENAULT TRUCKS

series SM

10 , T	- 12.79			3521.20.00	350 GF350KR	
12 , T				3516.30.00	350 10 350WGSZ	
15 .186	01.74 - 12.79			7951.40.00	KZIS - 4	
19 .240 (Sachs Version)	01.75 - 12.79			3835.20.00	380 GF380	- GBox: 343.02
26 .240 (Sachs Version)	01.75 - 12.79			3861.30.00	380 10 380W2GSZ	- GBox: 343.02
32 .240 6x6 (Sachs Version)	01.75 - 12.79			7951.40.00	KZIS - 4	- GBox: 343.02
19 .240 (Valeo Version)	01.75 - 12.79			3866.20.00	380 GM380K	- GBox: 343.02
21 .240 (Valeo Version)	01.74 - 12.79					
26 .240 (Valeo Version)	01.75 - 12.79					
260	11.77 - 12.79					
32 .230 6x4, 6x6						
32 .240 6x6 (Valeo Version)	01.75 - 12.79					
21 .180	01.76 - 12.78			3521.20.00	350 GF350KR	
				3516.30.00	350 10 350WGSZ	
21 .240 (Sachs Version)	01.74 - 12.79			3835.20.00	380 GF380	- GBox: 343.032
				3861.30.00	380 10 380W2GSZ	- GBox: 343.032
				7951.40.00	KZIS - 4	- GBox: 343.032
32 .230 6x4, 6x6	01.74 - 12.79			3861.30.00	380 10 380W2GSZ	- GBox: 343.02
				7951.40.00	KZIS - 4	- GBox: 343.02
32 .256	01.76 - 12.77			4226.20.00	420 GF420KR	- GBox: ZF
				4222.20.00	420 GF420KR	- GBox: ZF
				4283.30.00	420 10 420WGSZ	- GBox: ZF
				4203.30.00	420 10 420GS	- GBox: ZF
				7951.40.00	KZIS - 4	- GBox: ZF
32 .256 (Sachs Version)	01.76 - 12.77			4226.20.00	420 GF420KR	- GBox: Fuller
				4222.20.00	420 GF420KR	- GBox: Fuller
				4297.30.00	420 10 420GSZ	- GBox: Fuller
				7951.40.00	KZIS - 4	- GBox: Fuller
170	- 12.79			3521.20.00	350 GF350KR	- GBox: ZF
				3516.30.00	350 10 350WGSZ	- GBox: ZF
				7951.40.00	KZIS - 4	- GBox: ZF
200	01.71 - 12.74			3866.20.00	380 GM380K	- GBox: Saviem
240	01.71 - 12.79			3866.20.00	380 GM380K	- GBox: Saviem
240 (Sachs Version)	11.77 - 12.79			3835.20.00	380 GF380	- GBox: ZFAK6-80
				3861.30.00	380 10 380W2GSZ	- GBox: ZFAK6-80
				7951.40.00	KZIS - 4	- GBox: ZFAK6-80

Vehicle list



RENAULT TRUCKS

series SM

240 (Valeo Version)	11.77 - 12.79			3866.20.00	380 GM380K	- GBox: ZFAK6-80	
240 HT	01.74 - 12.79			3861.30.00	380 10 380W2GSZ		
					7951.40.00	KZIS - 4	
280	11.77 - 12.79			4226.20.00	420 GF420KR	- GBox: Fuller RTO 9509 - GBox: ZF	
					4222.20.00	420 GF420KR	- GBox: Fuller RTO 9509 - GBox: ZF
					4297.30.00	420 10 420GSZ	- GBox: Fuller RTO 9509
					7951.40.00	KZIS - 4	- GBox: Fuller RTO 9509 - GBox: ZF
					4283.30.00	420 10 420WGSZ	- GBox: ZF
					4203.30.00	420 10 420GS	- GBox: ZF
300	11.77 - 12.79			4226.20.00	420 GF420KR	- GBox: Fuller RTO 9509 - GBox: ZF	
					4222.30.00	420 10 420BH	- GBox: Fuller RTO 9509 - GBox: ZF
					4297.30.00	420 10 420GSZ	- GBox: Fuller RTO 9509
					7951.40.00	KZIS - 4	- GBox: Fuller RTO 9509 - GBox: ZF
					4283.30.00	420 10 420WGSZ	- GBox: ZF
					4203.30.00	420 10 420GS	- GBox: ZF
340 , T	01.74 - 12.79			4226.20.00	420 GF420KR	- GBox: ZF	
					4222.20.00	420 GF420KR	- GBox: ZF
					4283.30.00	420 10 420WGSZ	- GBox: ZF
					4203.30.00	420 10 420GS	- GBox: ZF
					7951.40.00	KZIS - 4	- GBox: ZF
340 , T				4226.20.00	420 GF420KR	- GBox: Fuller RTO	
					4222.20.00	420 GF420KR	- GBox: Fuller RTO
					4297.30.00	420 10 420GSZ	- GBox: Fuller RTO
					7951.40.00	KZIS - 4	- GBox: Fuller RTO

series SP

5	03.75 -			2525.20.00	250 MF250	- GBox: 321
---	---------	--	--	-------------------	---------------------	-------------



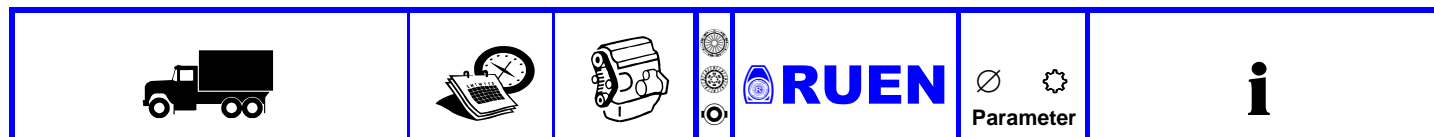



Vehicle list



















RENAULT TRUCKS

T - Serie		01.13 -				
380P LOW 11MM016GV004	01.13 -	DTI11-122HH		4300.90.129 ⊕	430 24	- Engine code: DTI 11
380P, 380P LOW 11MJ016ST004, 11MJ016LW004	01.13 -	DTI11-122HI		4382.60.00	MFZ430	- Engine code: DTI 13
380P, 380P LOW 11MM016MS004, 11MM016GV014	01.13 -	DTI11-122HJ		4398.30.00	430WGTZ	- GBox: MT 2214B / MT 2514B, MTO 2214B/MTO 2514B
380T LOW, 380T TAG	01.13 -	DTI13-122HK		8641.47.00	PHIS-6/38	- Engine code: DTI 11
11MD016LW004, 11MD016TAG04	01.13 -					- Engine code: DTI 13
380T PUS 11MC016PUS04	01.13 -					- GBox: AT 2412/E /AT 2612/E, ATO 2612/E
380T, 380T LOW, 380T X-LOW	01.13 -					
11MA016ST004, 11MA016LW004, 11MA016XLW04	01.13 -					
430P LOW 11MM016GV006	01.13 -					
430P, 430P LOW 11MJ016LW006, 11MJ016ST006	01.13 -					
430P, 430P LOW 11MM016GV016, 11MM016MS006	01.13 -					
430T PUS 11MC016PUS06	01.13 -					
430T TAG, 430T LOW	01.13 -					
11MD016TAG06, 11MD016LW006, 11MD017TAG06	01.13 -					
430T, 430T LOW, 430T X-LOW	01.13 -					
11MA016XW006, 11MA016ST006, 11MA016LW006, 11MA016XLW06, 11MA016CIT06	01.13 -					
440P LOW 10XM036GV004, 11MM016GV006, 11MM036GV004	01.13 -					
440P, 440P LOW 10XJ036ST004, 11MJ036ST004, 11MJ036LW004, 10XJ036LW004	01.13 -					
440P, 440P LOW 10XM036MS004, 10XM036GV014, 11MM036GV014, 11MM036MS004	01.13 -					
440T LOW, 440T TAG 10XD036TAG04, 11MD036TAG04, 10XD036LW004, 11MD036LW004	01.13 -					
440T PUS 11MC036PUS04, 10XC036PUS04	01.13 -					
440T, 440T LOW, 440T X-LOW	01.13 -					
11MA016LW008, 11MA036XLW04, 11MA036ST004, 10XA036LW004, 10XA036XLW04, 10XA036ST004	01.13 -					
460P LOW 11MM016GV008	01.13 -					
460P, 460P LOW 11MJ016ST008, 11MJ016LW008	01.13 -					
460P, 460P LOW 11MM016GV018, 11MM016MS008	01.13 -					
460T LOW, 460T TAG	01.13 -					
11MD016TAG08, 11MD016LW008	01.13 -					
460T PUS 11MC016PUS08	01.13 -					
460T, 460T LOW, 460T X-LOW	01.13 -					
11MA016LW008, 11MA016CIT08, 11MA016ST008, 11MA016XLW08	01.13 -					







Vehicle list

					
---	---	---	--	---	---

RENAULT TRUCKS





T - Serie		01.13 -			
480P LOW 10XM036GV006, 11MM036GV006	01.13 -	DTI13-122HL DTI13-122HM	 4300.90.129 ⊕  4382.60.00  4398.30.00	430 24 MFZ430 430WGTZ	- Engine code: DTI 13 - Engine code: DTI 11 - GBox: AT 2412/E /AT 2612/E, ATO 2612/E - GBox: MTO 2514B
480P, 480P LOW 10XJ036ST006, 11MJ036LW006, 11MJ036ST006, 10XJ036LW006	01.13 -				
480P, 480P LOW 11MM036GV016, 11MM036MS006, 10XM036MS006, 10XM036GV016	01.13 -		 8641.47.00	PHIS-6/38	- Engine code: DTI 13 - Engine code: DTI 11 - GBox: AT 2412/E /AT 2612/E, ATO 2612/E
480T LOW, 480T TAG 10XD036TAG06, 11MD036LW006, 11MD036TAG06, 10XD036LW006	01.13 -				
480T PUS 11MC036PUS06, 10XC036PUS06	01.13 -				
480T, 480T LOW, 480T X-LOW 10XA036LW006, 11MA036LW006, 10XA036ST006, 10XA036XLW06, 11MA036ST006, 11MA036XLW06	01.13 -				
520P LOW 10XM036GV008, 11MM036GV008	01.13 -				
520P, 520P LOW 11MJ036ST008, 10XJ036ST008, 11MJ036LW008, 10XJ036LW008	01.13 -				
520P, 520P LOW 11MM036GV018, 10XM036MS008, 11MM036MS008, 10XM036GV018	01.13 -				
520T LOW, 520T TAG 11MD036TAG08, 11MD036TGA08, 10XD036LW008, 11MD036LW008, 10XD036TAG08	01.13 -				
520T PUS 11MC036PUS08, 10XC036PUS08, 10XD036PUS08	01.13 -				
520T, 520T LOW, 520T X-LOW 10XA036XLW08, 10XA036ST008, 11MA036XLW08, 10XA036LW008, 11MA036LW008, 11MA036ST008	01.13 -				
TB					
191 A,B,C,E,F,G	10.78 - 10.81		 3866.20.00	380 GM380K	- GBox: 6 G
191 B,C,E,F,G	11.81 -		 3866.20.00	380 GM380K	- GBox: 10 G
TL					
TLM 280	01.80 - 03.86		 4343.30.00	430 10 430GTZ	- Engine code: MIDS063540 - GBox: Fuller RTO 9509
TLM 280	01.80 -		 4342.30.00	430 20 430GTZ	- Engine code: MIDS063540 - GBox: B9/B18
			 4309.30.00	430 20 430WGVZ	
			 8936.40.00	KZISZ - 5	
series TP					
3 MB 35, 39 4x4	01.75 - 01.79 02.79 - 12.83		 2525.20.00	250 MF250	- GBox: 321
TR					
M 10000	11.92 -		 4335.60.00 ⊕  4342.30.00	430 MFZ430 430 20 430GTZ	- Engine code: MIDS062045B - GBox: B18 - Engine code: MIDS062045B - GBox: B18
			 8938.46.00		- Engine code: MIDS062045B - GBox: B18
M 10000	- 10.92		 4342.30.00  8936.40.00	430 20 430GTZ KZISZ - 5	

Vehicle list





					
---	---	---	--	---	---

RENAULT TRUCKS









TR

M 10000 Militär	- 10.92		4342.30.00	430 20 430GTZ	
			8936.40.00	KZISZ - 5	
280 , A	01.74 - 12.84		4342.30.00	430 20 430GTZ	- GBox: B9.150
M 2000 M 2000 Militär	11.92 -		2525.20.00	250 MF250	- Engine code: 720 - GBox: ZFS5-24

series 85 - 90

85.150 TI 4x4 (10G.)	10.85 -		3500.90.42  3574.20.00  3587.30.00  8525.40.00	350 10 14" MF 350 350GSZ KZIS-3	- Engine code: MIDS060212B - GBox: ZFS5-35+BT232S
90 B (5G.) 90 B 6	01.78 - 12.80 01.78 - 12.80		2525.20.00	250 MF250	- GBox: ZF - GBox: 321

100

130 B (5G.)	01.78 - 12.80		3100.90.01  3169.20.00  3113.30.00  6905.40.00	310 10 MF310 310GSBL KZIS - 3	- GBox: 797 - GBox: ZF
110.150 TI 4x4 (10G.) 150 B (5G.)	10.85 - 01.76 - 12.80		3500.90.42  3574.20.00  3587.30.00  8525.40.00	350 10 14" MF 350 350GSZ KZIS-3	- Engine code: MIDS060212B - Engine code: 798 - GBox: ZF
110.170 4x4 (6G.) 130 TB (6G.)	09.85 - 01.76 - 12.80		3574.20.00	350 14" MF 350	- Engine code: 797 - GBox: ZF - GBox: ZF S6-65



series 300

380 K 4x4	01.73 - 12.81		2822.20.00	280 MF280	
-----------	---------------	---	-------------------	---------------------	--

series 400

440 K	01.74 - 12.79		2822.20.00	280 MF280	
-------	---------------	---	-------------------	---------------------	--





series 500

500 K 550 K 560 K	01.72 - 12.79 01.72 - 12.79 01.74 - 12.79		2822.20.00	280 MF280	
560 K 6 560 KB	01.77 - 12.79		3173.20.00	310 MF310	







series 600

600 KB 610 K 6 610 KB 620 KB 680 KB	01.74 - 12.75 01.77 - 12.79 01.76 - 12.79 01.74 - 12.75		3173.20.00	310 MF310	
---	--	---	-------------------	---------------------	--

series 700

700 KB	01.75 - 12.79		3173.20.00	310 MF310	
770 K. KB	01.73 - 12.75		3173.20.00	310 MF310	- GBox: BXSL 109
770 KB 6, SP			3866.20.00	380 GM380K	
770 KB, KBK (5G.)	01.74 - 03.78		3173.20.00	310 MF310	- GBox: ZF S5-35
			3113.30.00	310 10 310GSBL	- GBox: ZF S5-35

Vehicle list





					
---	---	---	--	---	---

RENAULT TRUCKS





series 700

770 KB, KBK (5G.)	04.78 - 12.79		3587.30.00	350 10 350GSZ	- Engine code: MDO42030 - GBox: ZF
-------------------	---------------	---	-------------------	-------------------------	---------------------------------------

series 800



880 KB	01.74 - 12.78		3173.20.00	310 MF310	- GBox: BXSL 109
881 KB, KBD (5G.)	- 03.78		3173.20.00	310 MF310	- GBox: ZF S5-35
			3113.30.00	310 10 310GSBL	- GBox: ZF S5-35
880 KB (5G.)	04.78 -		3587.30.00	350 10 350GSZ	- Engine code: MDO42030 - GBox: ZF
881 KB, KBD (5G.)	04.78 - 12.79				

series 900





950 KB, KBT	- 12.79		3866.20.00	380 GM380K	
950 KB, KBT 6 (6G.)	01.76 - 12.79		3866.20.00	380 GM380K	
950 KBT 6E	01.75 - 12.79		3866.20.00	380 GM380K	
950, 951 KB (5G.)	01.73 - 12.79		3587.30.00	350 10 350GSZ	- Engine code: MDO42030 - GBox: ZF

SCANIA



65

CF 65				4201.20.00	420 G420KR	
				4208.30.00	420 10 420GS	



75

B 75 CF 75				4201.20.00	420 G420KR	
				4208.30.00	420 10 420GS	
L 75 LS 75				4201.20.00	420 G420KR	
				4208.30.00	420 10 420GS	





76

L 76 LS 76				4201.20.00	420 G420KR	
				4209.30.00	420 10 420GS	







80

L 80 LB 80				4201.20.00	420 G420KR	- Engine code: K422-1
				4209.30.00	420 10 420GS	- Engine code: K422-1 - Engine code: K422-3
				4261.20.00	420 GMF420K	- Engine code: K422-3





























81

L 81 LB 81				4201.20.00	420 G420KR	- Engine code: K422-1
				4209.30.00	420 10 420GS	- Engine code: K422-1
				4261.20.00	420 GMF420K	- Engine code: K422-3
				4261.30.00	420 22 420GSZ	- Engine code: K422-3







Vehicle list

					
---	---	---	--	---	---

SCANIA











85					
L 85 LB 85			4201.20.00	420 G420KR	- Engine code: K422-1
			4209.30.00	420 10 420GS	- Engine code: K422-1 - Engine code: K422-3
			4261.20.00	420 GMF420K	- Engine code: K422-3
LBS 85			4261.20.00	420 GMF420K	- Engine code: K422-3
			4209.30.00	420 10 420GS	- Engine code: K422-3
LS 85			4201.20.00	420 G420KR	- Engine code: K422-1
			4209.30.00	420 10 420GS	- Engine code: K422-1 - Engine code: K422-3
			4261.20.00	420 GMF420K	- Engine code: K422-3
86					
L 86 LB 86			4201.20.00	420 G420KR	- Engine code: K422-1
			4209.30.00	420 10 420GS	- Engine code: K422-1
			4261.20.00	420 GMF420K	- Engine code: K422-3
			4261.30.00	420 22 420GSZ	- Engine code: K422-3
110					
L 110 LB 110 LBS 110 LBT 110 LS 110 LT 110			4201.20.00	420 G420KR	- Engine code: K422-1 - To model year: 12.1975
			4209.30.00	420 10 420GS	- Engine code: K422-1 - To model year: 12.1975
			4263.20.00	420 GMF420K	- Engine code: K422-4 - From model year: 01.1976
			4208.30.00	420 10 420GS	- Engine code: K422-4 - From model year: 01.1976
111					
BF 111			4263.20.00	420 GMF420K	- Engine code: K422-4 - GBox: G763
			4208.30.00	420 10 420GS	- Engine code: K422-4 - GBox: G763
L 111			4261.20.00	420 GMF420K	- Engine code: K422-3 - GBox: G770,GR870
			4261.30.00	420 22 420GSZ	- Engine code: K422-3 - GBox: G770,GR870
			4201.20.00	420 G420KR	- Engine code: K422-1 - GBox: G760,GR860
			4209.30.00	420 10 420GS	- Engine code: K422-1 - GBox: G760,GR860
			4263.20.00	420 GMF420K	- Engine code: K422-4 - Engine code: K422-9 - GBox: G760,770/Gr860,870
			4200.90.84   4263.20.00  4261.30.00	420 22 GMF420K 420GSZ	- Engine code: K422-4 - Engine code: K422-9 - GBox: G760,770/GR860,870
			4208.30.00	420 10 420GS	- Engine code: K422-4 - GBox: G760,GR860

Vehicle list

					
---	---	---	--	---	---









SCANIA

111

LB 111				4200.90.84 	420 22 GMF420K 420GSZ	- Engine code: K422-9 - GBox: G770,GR870	
					4263.20.00	420 GMF420K	- Engine code: K422-9 - GBox: G770,GR870 - Engine code: K422-4
					4261.30.00	420 22 420GSZ	- Engine code: K422-9 - GBox: G770,GR870
					4208.30.00	420 10 420GS	- Engine code: K422-4 - GBox: G760,GR860
					4201.20.00	420 G420KR	- Engine code: K422-1 - GBox: G760,GR860
					4209.30.00	420 10 420GS	- Engine code: K422-1 - GBox: G760,GR860
LBS 111				4263.20.00	420 GMF420K	- Engine code: K422-4 - GBox: G460,GR860	
					4209.30.00	420 10 420GS	- Engine code: K422-4 - GBox: G760,GR860
LS 111				4263.20.00	420 GMF420K	- Engine code: K422-4 - GBox: G760,GR860	
					4209.30.00	420 10 420GS	- Engine code: K422-4 - GBox: G760,GR860

2 - series

05.80 - 05.88

82 M/190, Platform/Chassis, 4x2	10.82 - 03.88	DS 8		4200.90.84 	420 22 GMF420K 420GSZ	- Engine code: DN8,DS8,11,DSC11,DS	
82 M/210, Platform/Chassis, 4x2	01.81 - 12.86	DS 8.01			4263.20.00		
82 M/210, Platform/Chassis, 6x2	01.81 - 12.86	DS 8.01 B10			4261.30.00		
82 M/210, Platform/Chassis, 6x4	01.81 - 12.86	DS 8.01 B11					
82 M/210, Truck Tractor, 4x2	01.81 - 12.86	DS 8.01 B12 DS 8.05 DS 8.06					
92 M/245, Platform/Chassis, 4x2	01.85 - 12.86	DS 9.01		4200.90.84 	420 22 GMF420K 420GSZ	- Engine code: DN8,DS8,11,DSC11,	
92 M/245, Platform/Chassis, 6x2	01.85 - 12.86	DSC 9.01			4263.20.00		
92 M/245, Truck Tractor, 4x2	01.85 - 12.86			4261.30.00			
92 M/245, Platform/Chassis, 4x2	01.87 - 12.88			4211.30.00	420 22 420/210GSZ	- Engine code: DN11,DS11 - GBox: GRE870	
92 M/245, Platform/Chassis, 6x2	01.87 - 12.88						
92 M/245, Truck Tractor, 4x2	01.87 - 12.88						
92 M/275, Platform/Chassis, 4x2	01.85 - 03.88						
92 M/275, Platform/Chassis, 6x2	01.85 - 12.86						
92 M/275, Truck Tractor, 4x2	01.85 - 12.86						
92 M/275, Platform/Chassis, 4x2	01.87 - 12.88						
92 M/275, Platform/Chassis, 6x2	01.87 - 12.88						
92 M/275, Truck Tractor, 4x2	01.87 - 12.88						
92 H/245, 16.00t, Platform/Chassis, 4x2	01.85 - 12.86						
92 H/245, 17.00t, Platform/Chassis, 4x2	01.87 - 12.88						

Vehicle list



SCANIA

2 - series 05.80 - 05.88

112 M/305, Platform/Chassis, 4x2	01.81 - 12.86	DS 11.14		4200.90.84	420 22	- Engine code: DN8,DS8,11,DSC11,
112 M/305, Platform/Chassis, 6x2	01.81 - 12.86	DS 11.15		4263.20.00	GMF420K	
112 M/305, Truck Tractor, 4x2	01.81 - 12.86			4261.30.00	420GSZ	
112 M/305, Truck Tractor, 6x4	01.81 - 12.86			4211.30.00	420 22	- Engine code: DN11,DS11
112 H/280, Dump Truck, 4x2	01.81 - 12.86				420/210GSZ	- GBox: GRE870
112 H/280, Dump Truck, 6x2	01.81 - 12.86					
112 H/280, Dump Truck, 6x4	01.81 - 12.86					
112 H/280, Platform/Chassis, 4x2	01.81 - 12.86					
112 H/280, Platform/Chassis, 6x2	01.81 - 12.86					
112 H/280, Platform/Chassis, 6x4	01.81 - 12.86					
112 H/280, Truck Tractor, 4x2	01.81 - 12.86					
112 H/280, Truck Tractor, 6x2	01.81 - 12.86					
112 H/280, Truck Tractor, 6x4	01.81 - 12.86					
112 H/305, Dump Truck, 4x2	01.81 - 12.86					
112 H/305, Dump Truck, 6x2	01.81 - 12.86					
112 H/305, Dump Truck, 6x4	01.81 - 12.86					
112 H/305, Platform/Chassis, 4x2	01.81 - 08.91					
112 H/305, Platform/Chassis, 6x2	01.81 - 12.86					
112 H/305, Platform/Chassis, 6x4	01.81 - 12.86					
112 H/305, Truck Tractor, 4x2	01.81 - 12.86					
112 H/305, Truck Tractor, 6x2	01.81 - 12.86					
112 H/305, Truck Tractor, 6x4	01.81 - 12.86					
142 M/390, Platform/Chassis, 4x2	05.80 - 03.88	DS 14.06		3878.30.00	380 22	- Engine code: DS,DSC14
142 M/390, Platform/Chassis, 6x2	05.80 - 03.88	DSC 14.01			380/210GSZ	- GBox: GR871
142 M/390, Truck Tractor, 4x2	05.80 - 03.88	DSC 14.02				- To chassis no.: 4263275
142 M/390, Truck Tractor, 6x2	05.80 - 03.88			4300.90.10	430 22	- Engine code: DS,DSC14
142 H/390, Platform/Chassis, 4x2	05.80 - 03.88			4330.60.00	MFZ430	- GBox: GR871/880
142 H/390, Platform/Chassis, 6x2	05.80 - 03.88			4302.30.00	430GTZ	- From chassis no.: 4263276
142 H/390, Platform/Chassis, 6x4	05.80 - 03.88			4313.20.00	430	- Engine code: DS,DSC14
142 H/390, Truck Tractor, 4x2	05.80 - 03.88				MFZ430	- GBox: GR871/880
142 H/390, Truck Tractor, 6x2	05.80 - 03.88					- From chassis no.: 4263276
142 H/390, Truck Tractor, 6x4	05.80 - 03.88			4313.26.00	430	
142 H/410, Platform/Chassis, 4x2	05.80 - 03.88				MFZ430	
142 H/410, Platform/Chassis, 6x2	05.80 - 03.88					
142 H/410, Platform/Chassis, 6x4	05.80 - 03.88					
142 H/410, Truck Tractor, 4x2	05.80 - 03.88					
142 H/410, 17.00t, Truck Tractor, 6x2	05.80 - 03.88					
142 H/410, 24.00t, Truck Tractor, 6x2	05.80 - 03.88					
142 H/410, Truck Tractor, 6x4	05.80 - 03.88					
142 E/390, Platform/Chassis, 6x4	05.80 - 03.88					
T 142 E/390, Platform/Chassis, 6x4	05.80 - 03.88					
82 H/210, 16.00t, 4x2	01.81 - 12.86	DS 8		4200.90.84	420 22	- Engine code: DN8,DS8,11,DSC11,DS
82 H/210, 22.00t, 6x2	01.81 - 12.86	DS 8.01		4263.20.00	GMF420K	
		DS 8.01 B10		4261.30.00	420GSZ	
		DS 8.01 B11				
		DS 8.01 B12				
		DS 8.05				
92 H/275, 16.00t, Platform/Chassis, 4x2	01.85 - 12.86	DSC 9.01		4200.90.84	420 22	- Engine code: DN8,DS8,11,DSC11,
92 H/275, 17.00t, Platform/Chassis, 4x2	01.87 - 12.88			4263.20.00	GMF420K	
112				4261.30.00	420GSZ	
				4211.20.00	420	- Engine code: DN11,DS11
					G420KR	- GBox: GRE870

Vehicle list

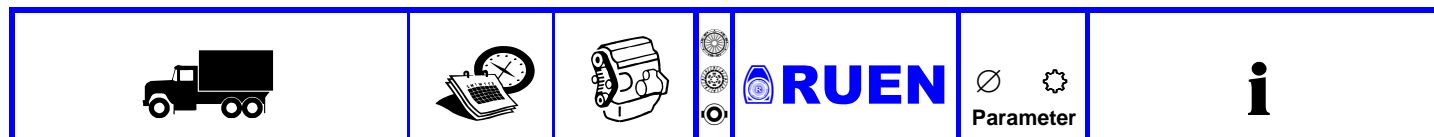

SCANIA

2 - series

05.80 - 05.88

142	05.80 - 03.88	DSC 14.01		3878.30.00	380 22 380/210GSZ	- To chassis no.: 4263275 - Engine code: DS,DSC14 - GBox: GR871
142 H/410, Platform/Chassis, 6x2	05.80 - 03.88	DSC 14.02		4300.90.10 ⊕ 4330.60.00 4302.30.00	430 22 MFZ430 430GTZ	- From chassis no.: 4263276 - Engine code: DS,DSC14 - GBox: GR871/880
				4313.20.00	430 MFZ430	- From chassis no.: 4263276 - Engine code: DS,DSC14 - GBox: GR871/880
				4313.26.00	430 MFZ430	

3 - series

01.88 - 12.96

93 M/210	03.88 - 12.91	DS 11.34		4000.90.61 ⊕ 4060.60.00 4052.30.00	400 22 MFZ400X 400GVZ	- Engine code: K402-1
93 M/220, 25.00t, 6x2/4	12.91 - 12.96	DS 11.73		4000.90.60 ⊕ 4060.60.00 4051.30.00	400 24 MFZ400X 400WGVZ	- Engine code: K402-3
93 M/250, 17.00t, 4x2	03.88 - 12.89	DS 11.75		4211.30.00	420 22 420/210GSZ	- Engine code: K422-8
93 M/280, 17.00t, 4x2	03.88 - 12.89	DS 9.05		4200.90.84 ⊖ 4263.20.00 4261.30.00	420 22 GMF420K 420GSZ	- Engine code: K422-9
93 H/220	12.91 - 12.96	DS 9.08		42106.30.00	420 24 420WGVTZ	- Engine code: K422-12; K422-13 - From chassis no.: 1196681 - To chassis no.: 1217685
93 H/250, 26.00t, 6x4	01.90 - 12.96	DSC 11.06		4261.30.00	420 22 420GSZ	- Engine code: K432-3 - Only install together
93 H/280, 18.00t, Dump Truck	12.91 - 12.96	DSC 11.08		4300.90.24 ⊕ 4331.60.00 4302.30.00	430 22 MFZ430 430GTZ	- Engine code: K432-5
113 M/320, 18.00t, 4x2	01.90 - 12.96	DSC 11.13		4313.20.00	430 MFZ430	- Engine code: K432-5; K432-6
113 M/360, 18.00t, 4x2	01.90 - 12.96	DSC 11.16		4300.90.10 ⊕ 4330.60.00 4302.30.00	430 22 MFZ430 430GTZ	- Engine code: K432-6
113 M/380, 18.00t, 4x2	01.91 - 12.96	DSC 11.17		4300.90.11 ⊕ 4331.60.00 4333.30.00	430 24 MFZ430 430WGTZ	- Engine code: K432-7 - Engine code: K432-8 - Engine code: K432-10 - Engine code: K432-14
113 M/400, 18.00t, 4x2	01.93 - 12.96	DSC 11.21		8923.40.00	KZIZ - 5	
113 H/310, 25.00t, 6x4	01.90 - 12.91	DSC 11.22		4313.26.00	430 MFZ430	
113 H/320, 18.00t, 4x2	01.90 - 12.96	DSC 11.23				
113 H/360, 18.00t, 4x2	01.90 - 12.96	DSC 11.30				
113 H/380, 18.00t, 4x2	01.91 - 12.96	DSC 11.70				
113 E/320, Platform/Chassis, 6x4	11.91 - 12.96	DSC 14.03				
113 E/360, 26.00t, 6x4	01.90 - 12.96	DSC 14.04				
113 E/380, 26.00t, 6x4	01.91 - 12.96	DSC 14.06				
143 M/420, 18.00t, 4x2	01.91 - 12.96	DSC 14.08				
143 M/450, 17.00t, 4x2	05.88 - 12.89	DSC 14.09				
143 M/470, 17.00t, 4x2	03.88 - 12.89	DSC 14.10				
143 M/500, 18.00t, 4x2	01.91 - 12.96	DSC 14.16				
143 H/400, 17.00t, 4x2	05.88 - 12.89	DSC 9.02				
143 H/420, 18.00t, 4x2	01.91 - 12.96	DSC 9.07				
143 H/450, 17.00t, 4x2	05.88 - 12.89	DSC 9.08				
143 H/470, 17.00t, 4x2	03.88 - 12.89	DSC 9.10				
143 H/500, 18.00t, 4x2	01.91 - 12.96	DTC 11.01				
143 E/420, 26.00t, 6x4	01.91 - 12.96	DTC 11.02				
143 E/450, 26.00t, 6x4	01.88 - 12.96					
143 E/500, 26.00t, 6x4	01.91 - 12.96					
T 93 H/250, Platform/Chassis, 4x2	01.90 - 12.96					
T 93 H/280, Platform/Chassis, 4x2	12.91 - 12.96					
T 113 H/320, 18.00t, 4x2	01.90 - 12.96					
T 113 H/360, Truck Tractor, 4x2	01.90 - 12.96					
T 113 E/320, 26.00t, 6x4	01.90 - 12.96					
T 113 E/360, 26.00t, 6x4	01.90 - 12.96					
T 143 H/420, 18.00t, 4x2	01.91 - 12.96					
T 143 H/450, 18.00t, 4x2	01.90 - 12.96					
T 143 H/500, 18.00t, 4x2	01.91 - 12.96					
T 143 H/500, 25.00t, 6x2	01.91 - 12.96					
T 143 E/420, 26.00t, 6x4	01.91 - 12.96					
T 143 E/450, 26.00t, 6x4	01.88 - 12.96					

Vehicle list

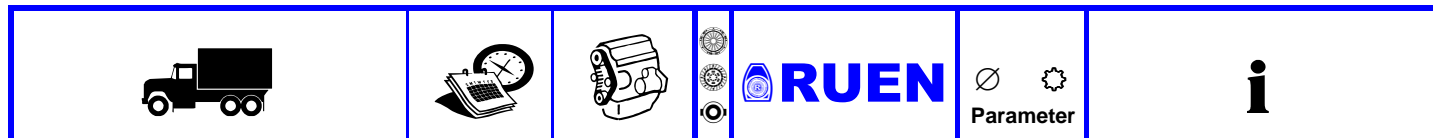

SCANIA

3 - series

01.88 - 12.96

93 M/230, 17.00t, 4x2	03.88 - 12.89	DS 9.05	4000.90.61 ⊕	400 22	- Engine code: K402-1
93 M/230, 24.00t, 6x2	03.88 - 12.89	DS 9.06	4060.60.00	MFZ400X	
93 M/230, 17.00t, 4x2	03.88 - 12.89	DSC 11.13	4052.30.00	400GVZ	
93 M/230, 18.00t, 4x2	01.90 - 12.91	DSC 11.16	4060.26.00	400	- Engine code: K402-1; K402-3
93 M/230, 25.00t, 6x2	01.90 - 12.91	DSC 11.17		MFZ400X	
93 M/230, 18.00t, 4x2	01.90 - 12.91	DSC 11.18	8923.46.00	KZIZ-5	- Engine code: K402-1; K402-3
93 M/250, 17.00t, 4x2	03.88 - 12.89	DSC 11.21	4000.90.60 ⊕	400 24	- Engine code: K402-3
93 M/250, 24.00t, 6x2/4	03.88 - 12.89	DSC 11.22	4060.60.00	MFZ400X	
93 M/250, 18.00t, 4x4	01.90 - 12.96	DSC 11.23	4051.30.00	400WGVZ	
93 M/250, 26.00t, 6x4	01.90 - 12.96	DSC 11.30	4051.30.00	400 24	- Engine code: K402-4
93 M/250, 18.00t, 4x2	01.90 - 12.96	DSC 11.70		400WGVZ	
93 M/250, 25.00t, 6x2/4	01.90 - 12.96	DSC 9.02	4211.30.00	420 22	- Engine code: K422-8
93 M/250, 26.00t, 6x4	01.90 - 12.96	DSC 9.07		420/210GSZ	
93 M/250, 18.00t, 4x2	01.90 - 12.96	DSC 9.08	4200.90.84 ⊖	420 22	- Engine code: K422-9
93 M/250, 26.00t, 6x4	10.90 - 12.96	DTC 11.01	4263.20.00	GMF420K	
93 M/280, 17.00t, 4x2	03.88 - 12.89	DTC 11.02	4261.30.00	420GSZ	
93 M/280, 24.00t, 6x2	03.88 - 12.89		4263.20.00	420	- Engine code: K422-12; K432-3 - Only install together
93 M/280, 26.00t, Concrete Mixer, 6x4	01.90 - 12.96		42106.30.00	420 24	- Engine code: K422-12 - From chassis no.: 1196681 - To chassis no.: 1217685 - Engine code: K422-13
93 M/280, 26.00t, Dump Truck, 6x4	01.90 - 12.96			420WGTZ	
93 M/280, 18.00t, 4x2	01.90 - 12.96				
93 M/280, 25.00t, 6x2/4	01.90 - 12.96		4261.30.00	420 22	- Engine code: K432-3 - Only install together
93 M/280, 26.00t, 6x4	01.90 - 12.96			420GSZ	
93 M/280, 18.00t, 4x2	01.90 - 12.96		4300.90.24 ⊕	430 22	- Engine code: K432-5
93 H/250	03.88 - 12.89		4331.60.00	MFZ430	
93 H/250, 24.00t, 6x4	01.89 - 12.89		4302.30.00	430GTZ	
93 H/250, 26.00t, 6x4	01.90 - 12.96		4313.20.00	430	- Engine code: K432-5; K432-6; K432-7, K432-8, K432-10, K432-14,
93 H/250, 18.00t, 4x4	01.90 - 12.96			MFZ430	
93 H/250, 18.00t, 4x2	01.90 - 12.96		4300.90.10 ⊕	430 22	- Engine code: K432-6
93 H/250, 26.00t, 6x4	01.90 - 12.96		4330.60.00	MFZ430	
93 H/280, Concrete Mixer, 6x4	12.91 - 12.96		4302.30.00	430GTZ	
93 H/280, 26.00t, Dump Truck	12.91 - 12.96		4300.90.11 ⊕	430 24	- Engine code: K432-7, - Engine code: K432-8, - Engine code: K432-10, - Engine code: K432-14,
93 H/280, Platform/Chassis, 4x2	12.91 - 12.96		4331.60.00	MFZ430	
93 H/280, Platform/Chassis, 6x4	12.91 - 12.96		4333.30.00	430WGTZ	
113 M/320, 32.00t, 8x4/4	01.90 - 12.96		4333.30.00	430 24	- Engine code: K432-13; K432-7, K432-8, K432-10, K432-14,
113 M/320, 25.00t, 6x2	01.90 - 12.96			430WGTZ	
113 M/320, 18.00t, 4x2	01.90 - 12.96		4313.26.00	430	
113 M/320, 25.00t, 6x2/4	01.90 - 12.96			MFZ430	
113 M/320, 26.00t, 6x4	01.90 - 12.96				
113 M/320, 17.00t, 4x2	05.88 - 12.89				
113 M/320, 24.00t, 6x2	05.88 - 12.89				
113 M/320, 17.00t, 4x2	05.88 - 12.89				
113 M/320, 24.00t, 6x2	05.88 - 12.89				
113 M/360, 32.00t, 8x4/4	01.90 - 12.96				
113 M/360, 25.00t, 6x2	01.90 - 12.96				
113 M/360, 18.00t, 4x2	01.90 - 12.96				
113 M/360, 25.00t, 6x2	01.90 - 12.96				
113 M/360, 17.00t, 4x2	05.88 - 12.89				
113 M/360, 24.00t, 6x2	05.88 - 12.89				
113 M/360, 17.00t, 4x2	05.88 - 12.89				
113 M/360, 24.00t, 6x2	05.88 - 12.89				
113 M/380, 25.00t, 6x2	01.91 - 12.96				
113 M/380, 18.00t, 4x2	01.91 - 12.96				
113 M/380, 25.00t, 6x2/4	01.91 - 12.96				
113 M/400, 25.00t, 6x2	01.92 - 12.96				
113 M/400, 18.00t, 4x2	01.92 - 12.96				

Vehicle list

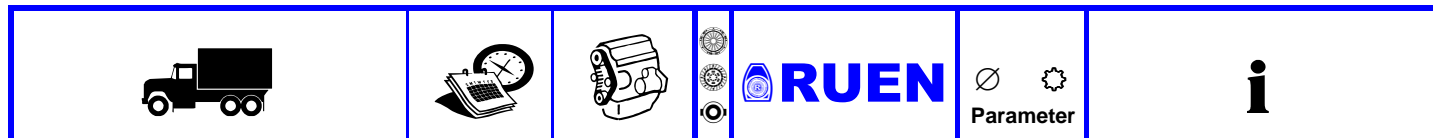

SCANIA

3 - series

01.88 - 12.96

113 H/310, 17.00t, 4x4	05.88 - 12.89	DS 11.34	4000.90.61 ⊕	400 22	- Engine code: K402-1
113 H/310, 24.00t, 6x4	05.88 - 12.89	DS 11.73	4060.60.00	MFZ400X	
113 H/310, 24.00t, 6x6	05.88 - 12.89	DS 11.75	4052.30.00	400GVZ	
113 H/310, 18.00t, 4x4	01.90 - 12.91	DSC 11.06	4060.26.00	400	- Engine code: K402-1; K402-3
113 H/310, 25.00t, 6x6	01.90 - 12.91	DSC 11.08		MFZ400X	
113 H/320, 25.00t, 6x4	01.90 - 12.96	DSC 11.13	8923.46.00	KZIZ-5	- Engine code: K402-1; K402-3
113 H/320, 32.00t, 8x4/4	01.90 - 12.96	DSC 11.16	4000.90.60 ⊕	400 24	- Engine code: K402-3
113 H/320, 18.00t, 4x4	01.90 - 12.96	DSC 11.17	4060.60.00	MFZ400X	
113 H/320, 25.00t, 6x4	01.90 - 12.96	DSC 11.18	4051.30.00	400WGVS	
113 H/320, 26.00t, 6x6	01.90 - 12.96	DSC 11.21			
113 H/320, 26.00t, 6x6	01.90 - 12.96	DSC 11.22	4051.30.00	400 24	- Engine code: K402-4
113 H/320, 32.00t, 8x4/4	01.90 - 12.96	DSC 11.23		400WGVS	
113 H/320, 25.00t, 6x2	01.90 - 12.96	DSC 11.30	4211.30.00	420 22	- Engine code: K422-8
113 H/320, 26.00t, 6x4	01.90 - 12.96	DSC 11.70		420/210GSZ	
113 H/320, 32.00t, 8x2/4	01.90 - 12.96		4200.90.84 ⊖	420 22	- Engine code: K422-9
113 H/320, 32.00t, 8x4/4	01.90 - 12.96		4263.20.00	GMF420K	
113 H/320, 18.00t, 4x2	01.90 - 12.96		4261.30.00	420GSZ	
113 H/320, 25.00t, 6x2	01.90 - 12.96		4263.20.00	420	- Engine code: K422-12; K432-3
113 H/320, 26.00t, 6x4	01.90 - 12.96			GMF420K	- Only install together
113 H/320, 17.00t, Dump Truck	05.88 - 12.89		42106.30.00	420 24	- Engine code: K422-12
113 H/320, 17.00t, Platform/Chassis	05.88 - 12.89			420WGTZ	- From chassis no.: 1196681
113 H/320, 24.00t, 6x2	05.88 - 12.89				- To chassis no.: 1217685
113 H/320, 24.00t, 6x4	05.88 - 12.89				- Engine code: K422-13
113 H/320, 17.00t, 4x2	05.88 - 12.89		4261.30.00	420 22	- Engine code: K432-3
113 H/320, 24.00t, 6x2	05.88 - 12.89			420GSZ	- Only install together
113 H/320, 24.00t, 6x2	05.88 - 12.89		4300.90.24 ⊕	430 22	- Engine code: K432-5
113 H/320, 24.00t, 6x4	05.88 - 12.89		4331.60.00	MFZ430	
113 H/320, 24.00t, 6x4	05.88 - 12.89		4302.30.00	430GTZ	
113 H/360, 25.00t, 6x4	01.90 - 12.96		4313.20.00	430	- Engine code: K432-5; K432-6; K432-7,
113 H/360, 32.00t, 8x4/4	01.90 - 12.96			MFZ430	K432-8, K432-10, K432-14,
113 H/360, 18.00t, 4x4	01.90 - 12.96		4300.90.10 ⊕	430 22	- Engine code: K432-6
113 H/360, 25.00t, 6x4	01.90 - 12.96		4330.60.00	MFZ430	
113 H/360, 26.00t, 6x6	01.90 - 12.96		4302.30.00	430GTZ	
113 H/360, 32.00t, 8x4/4	01.90 - 12.96		4300.90.11 ⊕	430 24	- Engine code: K432-7
113 H/360, 25.00t, 6x2	01.90 - 12.96		4331.60.00	MFZ430	- Engine code: K432-8
113 H/360, 26.00t, 6x4	01.90 - 12.96		4333.30.00	430WGTZ	- Engine code: K432-10
113 H/360, 32.00t, 8x2/4	01.90 - 12.96				- Engine code: K432-14
113 H/360, 32.00t, 8x4/4	01.90 - 12.96		4333.30.00	430 24	- Engine code: K432-13; K432-7, K432-8,
113 H/360, 18.00t, 4x2	01.90 - 12.96			430WGTZ	K432-10, K432-14,
113 H/360, 25.00t, 6x2/4	01.90 - 12.96		4313.26.00	430	
113 H/360, 26.00t, 6x4	01.90 - 12.96			MFZ430	
113 H/360, 17.00t, 4x2	05.88 - 12.89				
113 H/360, 24.00t, 6x2	05.88 - 12.89				
113 H/360, 24.00t, 6x4	05.88 - 12.89				
113 H/360, 17.00t, 4x2	05.88 - 12.89				
113 H/360, 24.00t, 6x2	05.88 - 12.89				
113 H/360, 24.00t, 6x4	05.88 - 12.89				
113 H/360, Dump Truck, 6x4	01.89 - 12.89				
113 H/360, Dump Truck, 6x6	01.89 - 12.89				
113 H/380, 32.00t, 8x4/4	01.91 - 12.96				
113 H/380, 25.00t, 6x4	01.91 - 12.96				
113 H/380, 32.00t, 8x4/4	01.91 - 12.96				
113 H/380, 25.00t, 6x2	01.91 - 12.96				
113 H/380, 26.00t, 6x4	01.91 - 12.96				
113 H/380, 18.00t, 4x2	01.91 - 12.96				
113 H/380, 25.00t, 6x2	01.91 - 12.96				
113 H/380, 26.00t, 6x4	01.91 - 12.96				

Vehicle list

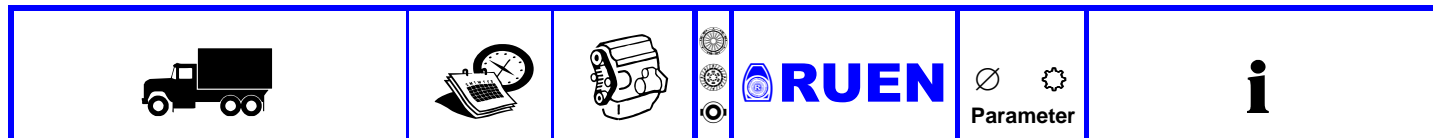

SCANIA

3 - series

01.88 - 12.96

113 E/320, Dump Truck, 6x4	11.91 - 12.96	DSC 11.13	4000.90.61 ⊕	400 22	- Engine code: K402-1
113 E/320, Dump Truck, 8x4/4	11.91 - 12.96	DSC 11.16	4060.60.00	MFZ400X	
113 E/320, Platform/Chassis, 8x4/4	11.91 - 12.96	DSC 11.17	4052.30.00	400GVZ	
113 E/360, 26.00t, 6x4	01.90 - 12.96	DSC 11.18	4060.26.00	400	- Engine code: K402-1; K402-3
113 E/360, 32.00t, 8x4/4	01.90 - 12.96	DSC 11.21		MFZ400X	
113 E/380, 26.00t, 6x4	01.91 - 12.96	DSC 11.22	8923.46.00	KZIZ-5	- Engine code: K402-1; K402-3
113 E/380, 32.00t, 8x4/4	01.91 - 12.96	DSC 11.23			
143 M/420, 25.00t, 6x2	01.91 - 12.96	DSC 11.30	4000.90.60 ⊕	400 24	- Engine code: K402-3
143 M/420, 18.00t, 4x2	01.91 - 12.96	DSC 11.70	4060.60.00	MFZ400X	
143 M/420, 25.00t, 6x2/4	01.91 - 12.96	DSC 14.03	4051.30.00	400WGVS	
143 M/450, 24.00t, 6x2	05.88 - 12.89	DSC 14.04	4051.30.00	400 24	- Engine code: K402-4
143 M/450, 17.00t, 4x2	05.88 - 12.89	DSC 14.06		400WGVS	
143 M/450, 24.00t, 6x2	05.88 - 12.89	DSC 14.08	4211.30.00	420 22	- Engine code: K422-8
143 M/450, 18.00t, 4x2	01.90 - 12.96	DSC 14.09		420/210GSZ	
143 M/450, 25.00t, 6x2	01.90 - 12.96	DSC 14.10	4200.90.84 ⊖	420 22	- Engine code: K422-8
143 M/450, 18.00t, 4x2	01.90 - 12.96	DSC 14.16	4263.20.00	GMF420K	
143 M/450, 25.00t, 6x2/4	01.90 - 12.96		4261.30.00	420GSZ	
143 M/470, Platform/Chassis, 4x2	01.88 - 12.96		4263.20.00	420	- Engine code: K422-12; K432-3
143 M/470, Truck Tractor, 4x2	01.88 - 12.96			GMF420K	- Only install together
143 M/470, 24.00t, 6x2	03.88 - 12.89		42106.30.00	420 24	- Engine code: K422-12
143 M/470, 17.00t, 4x2	03.88 - 12.89			420WGTZ	- From chassis no.: 1196681
143 M/470, 24.00t, 6x2	03.88 - 12.89				- To chassis no.: 1217685
143 M/470, Platform/Chassis, 6x2	01.90 - 05.91		4261.30.00	420 22	- Engine code: K432-3
143 M/470, Truck Tractor, 6x2	01.90 - 05.91			420GSZ	- Only install together
143 M/500, 25.00t, 6x2	01.91 - 12.96		4300.90.24 ⊕	430 22	- Engine code: K432-5
143 M/500, 18.00t, 4x2	01.91 - 12.96		4331.60.00	MFZ430	
143 M/500, 25.00t, 6x2/4	01.91 - 12.96		4302.30.00	430GTZ	
143 H/400, 18.00t, 4x2	01.88 - 12.96		4313.20.00	430	- Engine code: K432-5; K432-6; K432-7, K432-8, K432-10, K432-14,
143 H/400, 25.00t, 6x4	01.88 - 12.96			MFZ430	
143 H/400, 18.00t, 4x2	01.88 - 12.96		4300.90.10 ⊕	430 22	- Engine code: K432-6
143 H/400, 25.00t, 6x4	01.88 - 12.96		4330.60.00	MFZ430	
143 H/400, 24.00t, 6x2	05.88 - 12.89		4302.30.00	430GTZ	
143 H/400, 24.00t, 6x4	05.88 - 12.89		4300.90.11 ⊕	430 24	- Engine code: K432-7
143 H/400, 17.00t, 4x2	05.88 - 12.89		4331.60.00	MFZ430	- Engine code: K432-8
143 H/400, 24.00t, 6x2	05.88 - 12.89		4333.30.00	430WGTZ	- Engine code: K432-10
143 H/400, 24.00t, 6x4	05.88 - 12.89				- Engine code: K432-14
143 H/400, Platform/Chassis, 6x2	01.90 - 12.91		4333.30.00	430 24	- Engine code: K432-13; K432-7, K432-8, K432-10, K432-14,
143 H/400, Truck Tractor, 6x2	01.90 - 12.91		4313.26.00	430	
143 H/420, 25.00t, 6x4	01.91 - 12.93			MFZ430	
143 H/420, 25.00t, 6x2	01.91 - 12.96				
143 H/420, 26.00t, 6x4	01.91 - 12.96				
143 H/420, 18.00t, 4x2	01.91 - 12.96				
143 H/420, 25.00t, 6x2	01.91 - 12.96				
143 H/420, 26.00t, 6x4	01.91 - 12.96				
143 H/450, 26.00t, 6x4	01.88 - 12.96				
143 H/450, 24.00t, 6x2	05.88 - 12.89				
143 H/450, 24.00t, 6x4	05.88 - 12.89				
143 H/450, 17.00t, 4x2	05.88 - 12.89				
143 H/450, 24.00t, 6x2	05.88 - 12.89				
143 H/450, 24.00t, 6x4	05.88 - 12.89				
143 H/450, 18.00t, 4x2	01.90 - 12.96				
143 H/450, 25.00t, 6x2	01.90 - 12.96				
143 H/450, 18.00t, 4x2	01.90 - 12.96				
143 H/450, 25.00t, 6x2	01.90 - 12.96				
143 H/450, 26.00t, 6x4	01.90 - 12.96				

Vehicle list



SCANIA

3 - series 01.88 - 12.96

93 M/220, 18.00t, 4x2	12.91 - 12.96	DS 9.05	4000.90.61 ⊕	400 22	- Engine code: K402-1
93 M/220, 25.00t, 6x2	12.91 - 12.96	DSC 11.13	4060.60.00	MFZ400X	
93 M/220, 18.00t, 4x2	12.91 - 12.96	DSC 11.16	4052.30.00	400GVZ	
93 M/250, 24.00t, 6x2	03.88 - 12.89	DSC 11.17	4060.26.00	400	- Engine code: K402-1; K402-3
93 M/250, 25.00t, 6x2	01.90 - 12.96	DSC 11.18		MFZ400X	
93 M/280, 25.00t, 6x2	01.90 - 12.96	DSC 11.21	8923.46.00	KZIZ-5	- Engine code: K402-1; K402-3
113 M/320, 25.00t, 6x2	01.90 - 12.96	DSC 11.22	4000.90.60 ⊕	400 24	- Engine code: K402-3
113 M/380, 25.00t, 6x2	01.91 - 12.96	DSC 11.23	4060.60.00	MFZ400X	
113 H/360, 25.00t, 6x2	01.90 - 12.96	DSC 11.30	4051.30.00	400WGVZ	
143 H/470, 25.00t, 6x4	01.88 - 12.96	DSC 14.03	4051.30.00	400 24	- Engine code: K402-4
143 H/470, 18.00t, 4x2	01.88 - 12.96	DSC 14.04		400WGVZ	
143 H/470, 25.00t, 6x4	01.88 - 12.96	DSC 14.08	4211.30.00	420 22	- Engine code: K422-8
143 H/470, 24.00t, 6x2	03.88 - 12.89	DSC 14.09		420/210GSZ	
143 H/470, 24.00t, 6x4	03.88 - 12.89	DSC 14.10	4200.90.84 ⊖	420 22	- Engine code: K422-9
143 H/470, 17.00t, 4x2	03.88 - 12.89	DSC 14.16	4263.20.00	GMF420K	
143 H/470, 24.00t, 6x4	03.88 - 12.89	DSC 9.02	4261.30.00	420GSZ	
143 H/470, 18.00t, 4x2	01.90 - 05.91	DSC 9.07	4263.20.00	420	- Engine code: K422-12; K432-3
143 H/470, 25.00t, 6x2	01.90 - 05.91	DSC 9.08		GMF420K	- Only install together
143 H/500, 25.00t, 6x2	01.91 - 12.96	DSC 9.10	42106.30.00	420 24	- Engine code: K422-12
143 H/500, 26.00t, 6x4	01.91 - 12.96			420WGTZ	- From chassis no.: 1196681
143 H/500, 18.00t, 4x2	01.91 - 12.96				- To chassis no.: 1217685
143 H/500, 25.00t, 6x2	01.91 - 12.96				- Engine code: K422-13
143 H/500, 26.00t, 6x4	01.91 - 12.96		4261.30.00	420 22	- Engine code: K432-3
143 H/500, 26.00t, 6x4	01.91 - 12.96			420GSZ	- Only install together
143 E/420, 26.00t, 6x4	01.91 - 12.96		4300.90.24 ⊕	430 22	- Engine code: K432-5
143 E/420, 32.00t, 8x4/4	01.91 - 12.96		4331.60.00	MFZ430	
143 E/420, 26.00t, 6x4	01.91 - 12.96		4302.30.00	430GTZ	
143 E/450, 26.00t, 6x4	01.88 - 12.96		4313.20.00	430	- Engine code: K432-5; K432-6; K432-7, K432-8, K432-10, K432-14,
143 E/450, 32.00t, 8x4/4	01.88 - 12.96		4300.90.10 ⊕	430 22	- Engine code: K432-6
143 E/450, 26.00t, 6x4	01.88 - 12.96		4330.60.00	MFZ430	
143 E/500, 26.00t, 6x4	01.91 - 12.96		4302.30.00	430GTZ	
143 E/500, 26.00t, 8x4/4	01.91 - 12.96		4300.90.11 ⊕	430 24	- Engine code: K432-7
143 E/500, 26.00t, 6x4	01.91 - 12.96		4331.60.00	MFZ430	- Engine code: K432-8
T 93 H/250, Dump Truck, 6x4	01.90 - 12.96		4333.30.00	430WGTZ	- Engine code: K432-10
T 93 H/250, Platform/Chassis, 6x4	01.90 - 12.96				- Engine code: K432-14
T 93 H/280, Dump Truck, 6x4	12.91 - 12.96		4333.30.00	430 24	- Engine code: K432-13; K432-7, K432-8, K432-10, K432-14,
T 93 H/280, Platform/Chassis, 6x4	12.91 - 12.96		4313.26.00	430	
T 113 H/320, 26.00t, 6x4	01.90 - 12.96			MFZ430	
T 113 H/320, 25.00t, 6x2	01.90 - 12.96				
T 113 H/320, 26.00t, 6x4	01.90 - 12.96				
T 113 H/320, 18.00t, 4x2	01.90 - 12.96				
T 113 H/320, 25.00t, 6x2	01.90 - 12.96				
T 113 H/320, 26.00t, 6x4	01.90 - 12.96				
T 113 H/360, Dump Truck, 6x4	01.90 - 12.96				
T 113 H/360, Platform/Chassis, 6x4	01.90 - 12.96				
T 113 H/360, Truck Tractor, 6x2	01.90 - 12.96				
T 113 H/360, Truck Tractor, 6x4	01.90 - 12.96				
T 113 E/320, 26.00t, 6x4	01.90 - 12.96				
T 113 E/360, 26.00t, 6x4	01.90 - 12.96				
T 143 H/420, 25.00t, 6x2	01.91 - 12.96				
T 143 H/420, 18.00t, 4x2	01.91 - 12.96				
T 143 H/420, 25.00t, 6x2	01.91 - 12.96				
T 143 H/450, 25.00t, 6x2	01.90 - 12.96				
T 143 E/500, 26.00t, 6x4	01.91 - 12.96				

Vehicle list



SCANIA

3 - series 01.88 - 12.96

Vehicle Model	Period	DSC Code	Clutch Part Number	Clutch Size	Notes
143 M/420, 25.00t, 6x2	01.91 - 12.96	DSC 14.03	4000.90.61 ⊕	400 22	- Engine code: K402-1
143 M/450, 25.00t, 6x2	01.90 - 12.96	DSC 14.08	4060.60.00	MFZ400X	
143 M/500, 25.00t, 6x2	01.91 - 12.96	DSC 14.09	4052.30.00	400GVZ	
		DSC 14.10	4060.26.00	400	- Engine code: K402-1; K402-3
		DSC 14.16	8923.46.00	MFZ400X	
			4000.90.60 ⊕	400 24	- Engine code: K402-3
			4060.60.00	MFZ400X	
			4051.30.00	400WGVZ	
			4051.30.00	400 24	- Engine code: K402-4
			4211.30.00	400WGVZ	
			4200.90.84 ⊖	420 22	- Engine code: K422-8
			4263.20.00	420/210GSZ	
			4261.30.00	420 22	- Engine code: K422-9
			4263.20.00	GMF420K	
			42106.30.00	420GSZ	- Engine code: K422-12; K432-3 - Only install together
			4261.30.00	420 24	- Engine code: K422-12
			4300.90.24 ⊕	420WGTZ	- From chassis no.: 1196681 - To chassis no.: 1217685 - Engine code: K422-13
			4331.60.00	420 22	- Engine code: K432-3
			4302.30.00	420GSZ	- Only install together
			4313.20.00	430 22	- Engine code: K432-5
			4300.90.10 ⊕	MFZ430	
			4330.60.00	430GTZ	
			4302.30.00	430	- Engine code: K432-5; K432-6; K432-7, K432-8, K432-10, K432-14,
			4300.90.11 ⊕	MFZ430	- Engine code: K432-6
			4331.60.00	430GTZ	
			4333.30.00	430 22	- Engine code: K432-7, - Engine code: K432-8, - Engine code: K432-10, - Engine code: K432-14,
			4300.90.11 ⊕	MFZ430	
			4331.60.00	430WGTZ	
			4333.30.00	430 24	- Engine code: K432-13; K432-7, K432-8, K432-10, K432-14,
			4313.26.00	430WGTZ	
			4313.26.00	430	
			4313.26.00	MFZ430	

Vehicle list



SCANIA

4 - series 09.95 - 09.04

94 C/260 P94CB4X2HZ260	12.96 -	DC 11.02		4300.50.09	430 24	- Engine code: K432-16
94 C/310 P94CB6X4HZ310	08.96 -	DC 11.04		4328.20.00	MFZ430	
94 D/230 P94DB4X2NZ230, P94DA4X2NA230	08.99 -	DC 12.01		4333.30.00	430WGTZ	
94 D/310 P94DB4X2NB310, P94DB4X2LA310, P94DB4X2LZ310, P94DB4X2LB310, P94DB4X2NA310, P94DB4X2NZ310	12.96 -	DC 16.01		4300.90.09	430 24	- Engine code: K432-16
		DC 9.01		4328.20.00	MFZ430	
		DC 9.02		4333.30.00	430WGTZ	
		DC 9.04		8631.47.00	HHISZ-4	
94 G/310 P94GB4X2NZ310, R94GB4X2NB310, R94GB4X2NZ310, R94GB4X2NA310, P94GB4X2NB310, P94GB4X2NA310	08.96 -	DSC 12.01		4300.90.114	430 24	- Engine code: K432-19
		DSC 12.05		4378.20.00	MFZ430	
		DSC 14.13		4393.30.00	430WGTZ	
		DSC 9.12		4300.90.113	430 24	- Engine code: K432-33
		DSC 9.13		4393.20.00	MFZ430	
		DSC 9.15		4393.30.00	430WGTZ	
94 L/310 P94LA4X2LB310, P94LA4X2NB310, P94LA4X2LA310, P94LA4X2NA310	08.96 -	DT 12.02		8934.40.00	KZISZ - 5	
114 C/380 P114CB4X2HZ380	03.98 -	DT 12.06		4051.30.00	400 24	- Engine code: K402-4
114 G/380 R114GB4X2NB380, P114GB4X2NZ380, R114GB4X2NA380, P114GB4X2NA380, P114GB4X2NB380, R114GB4X2NZ380, R114LB4X2NB380, Platform/Chassis	03.98 -			8631.47.00	HHISZ-4	- Engine code: K402-5 - Engine code: K432-15 - Engine code: K432-16 - Engine code: K432-17 - Engine code: K432-19 - Engine code: K442-3
114 L/380 P114LB4X2LB380, P114LB4X2NB380, R114LB4X2LB380, R114LB4X2NA380, P114LB4X2NA380, R114LB4X2NB380	03.98 -					
124 C/400, 18.00t, Platform/Chassis, 4x2	09.96 -			4333.30.00	430 24	- Engine code: K432-13 - Engine code: K432-15 - Engine code: K432-17 - Engine code: K432-30 - Engine code: K432-32
124 G/400, Platform/Chassis, 4x2	05.96 -					
124 L/470 R124LA4X2NA470	01.01 -					
144 C/530, Platform/Chassis, 4x2	09.96 -			4313.20.00	430	- Engine code: K432-15 - Engine code: K432-17 - Engine code: K432-30 - Engine code: K432-31 - Engine code: K432-32
144 G/530 R144GB4X2NA530, R144GB4X2NZ530, R144GB4X2NB530	04.96 -				MFZ430	
144 L/530 R144LB4X2NB530, R144LB4X2NA530	11.95 -					
164 C/580, Platform/Chassis, 4x2	05.00 -			8934.40.00	KZISZ - 5	- Engine code: K432-30 - Engine code: K432-31 - Engine code: K432-32
164 G/580 R164GB4X2NB580, R164GB4X2NZ580, R164GB4X2NA580	05.00 -					
164 L/580 R164LB4X2NB580, R164LB4X2NA580	05.00 -			4313.26.00	430	
T 94 C/310, Truck Tractor, 4x2	09.96 -				MFZ430	
T 94 G/310, Truck Tractor, 4x2	12.96 -					
T 94 L/310	09.96 -					
T 114 C/380, Truck Tractor, 4x2	03.98 -					
T 114 G/380, Truck Tractor, 4x2	03.98 -					
T 114 L/380, 4x2	03.98 -					
T 124 C/420, Truck Tractor, 4x2	05.96 -					
T 124 G/420, Truck Tractor, 4x2	09.97 -					
T 124 L/470	01.01 -					
T 144 C/530, Truck Tractor, 4x2	09.95 -					
T 144 G/530, Platform/Chassis, 4x2	03.97 -					
T 144 L/530	03.97 -					

Vehicle list

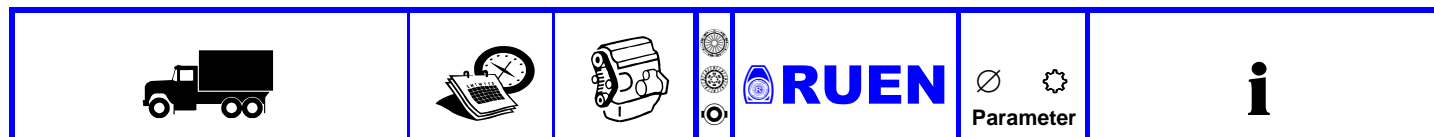

SCANIA

4 - series 09.95 - 09.04

94 C/260, 4x2	12.96 -	DC 9.01	4300.50.09	430 24	- Engine code: K432-16
94 C/260, 4x4	12.96 -	DC 9.02	4328.20.00	MFZ430	
94 C/260 P94CB6X4HZ260	12.96 -	DC 9.04	4333.30.00	430WGTZ	
94 C/260, 6x6	12.96 -	DC 9.05	4300.90.09	430 24	- Engine code: K432-16
94 C/260, 8x4/4	12.96 -	DSC 9.11	4328.20.00	MFZ430	
94 C/260	12.96 -	DSC 9.12	4333.30.00	430WGTZ	
94 C/310, Dump Truck, 4x2	08.96 -	DSC 9.13	8631.47.00	HHISZ-4	
94 C/310, Dump Truck, 4x4	08.96 -	DSC 9.15	4300.90.114	430 24	- Engine code: K432-19
94 C/310, Dump Truck, 6x4	08.96 -		4378.20.00	MFZ430	
94 C/310, Dump Truck, 6x6	08.96 -		4393.30.00	430WGTZ	
94 C/310, Dump Truck, 8x4/4	08.96 -		4300.90.113	430 24	- Engine code: K432-33
94 C/310 P94CB4X2HZ310	08.96 -		4393.20.00	MFZ430	
94 C/310, Platform/Chassis, 6x2	08.96 -		4393.30.00	430WGTZ	
94 C/310, Truck Tractor, 4x2	08.96 -		8934.40.00	KZISZ - 5	
94 D/220, 6x2/4	08.96 -		4051.30.00	400 24	- Engine code: K402-4
94 D/230, 4x2	08.99 -		8631.47.00	HHISZ-4	- Engine code: K402-5
94 D/230, 6x2/4	08.99 -				- Engine code: K432-15
94 D/260 P94DB4X2LB260, P94DB4X2LZ260, P94DB4X2NA260, P94DB4X2LA260, P94DB4X2NZ260, P94DB4X2NB260	08.96 -				- Engine code: K432-16
94 D/260, 6x2/4	08.96 -				- Engine code: K432-17
94 D/260 P94DA4X2NA260, P94DB4X2NZ260	08.96 -				- Engine code: K432-19
94 D/310 P94DB6X2*4NB310, P94DB6X2*4LA310, P94DB6X2*4LB310, P94DB6X2*4NA310	08.96 -				- Engine code: K442-3
94 D/310, 4x2	12.96 -		4333.30.00	430 24	- Engine code: K432-13
94 D/260 P94DA4X2NA260, P94DB4X2NZ260	08.96 -			430WGTZ	- Engine code: K432-15
94 D/310 P94DB6X2*4NB310, P94DB6X2*4LA310, P94DB6X2*4LB310, P94DB6X2*4NA310	08.96 -				- Engine code: K432-17
94 D/310, 4x2	12.96 -		4313.20.00	430	- Engine code: K432-30
94 G/220 P94GB4X2NA220, R94GB4X2NZ220, P94GB4X2NZ220, P94GB4X2NB220, R94GB4X2NA220, R94GB4X2NB220	08.96 -			MFZ430	- Engine code: K432-31
94 G/220, 4x2	08.96 -		8934.40.00	KZISZ - 5	- Engine code: K432-32
94 G/220, 6x2/4	01.98 -				- Engine code: K432-30
94 G/260 R94GB4X2NA260, R94GB4X2NB260, P94GB4X2NZ260, P94GB4X2NA260, P94GB4X2NB260, R94GB4X2NZ260	08.96 -				- Engine code: K432-31
94 G/260, 4x2	08.96 -		4313.26.00	430	- Engine code: K432-32
94 G/260, 6x2/4	01.98 -			MFZ430	
94 G/310, 6x2/4	08.96 -				
94 G/310 R94GA4X2NZ310, P94GA4X2NZ310, R94GA4X2NA310, P94GA4X2NA310	08.96 -				
94 L/310 P94LB4X2NA310, R94LB4X2NA310, P94LB4X2NB310, P94LB4X2LB310, R94LB4X2NB310	08.96 -				
94 L/310, Platform/Chassis, 6x2/4	08.96 -				
94 L/310, Platform/Chassis, 6x4	08.96 -				
94 L/310, Truck Tractor, 6x4	08.96 -				
T 94 C/260, 6x4	12.96 -				
T 94 C/260, 4x2	12.96 -				
T 94 C/260, 6x4	12.96 -				

Vehicle list

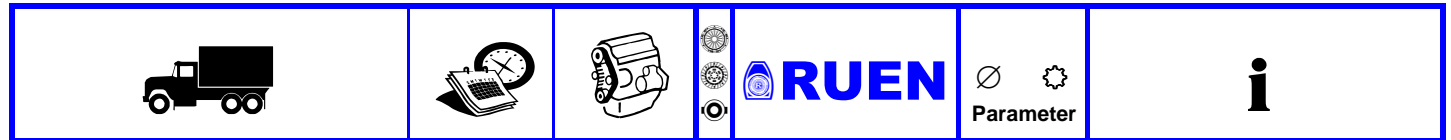

SCANIA

4 - series		09.95 - 09.04			
114 C/340, 4x2	05.96 -	DC 11.01	4300.50.09	430 24	- Engine code: K432-16
114 C/340, 4x4	05.96 -	DC 11.02	4328.20.00	MFZ430	
114 C/340, 6x4	05.96 -	DC 11.03	4333.30.00	430WGTZ	
114 C/340, 6x6	05.96 -	DC 11.04	4300.90.09	430 24	- Engine code: K432-16
114 C/340, 8x4/4	05.96 -	DC 9.01	4328.20.00	MFZ430	
114 C/340 P114CB4X2HZ340, 4x2	05.96 -	DC 9.03	4333.30.00	430WGTZ	
114 C/340 P114CB6X4NZ340, 6x4	05.96 -	DSC 11.79	8631.47.00	HHISZ-4	
114 C/340 P114CA4X2HZ340, 4x2	05.96 -	DSC 9.11	4300.90.114	430 24	- Engine code: K432-19
114 C/340, 6x4	05.96 -	DSC 9.12	4378.20.00	MFZ430	
114 C/340, 4x2	03.98 -	DSC 9.13	4393.30.00	430WGTZ	
114 C/340, 4x4	03.98 -	DSC 9.15	4300.90.113	430 24	- Engine code: K432-33
114 C/340, 6x4	03.98 -		4393.20.00	MFZ430	
114 C/340, 6x6	03.98 -		4393.30.00	430WGTZ	
114 C/340, 8x4/4	03.98 -		8934.40.00	KZISZ - 5	
114 C/340 P114CB4X2HZ340	03.98 -		4051.30.00	400 24	- Engine code: K402-4
114 C/340 P114CB6X4NZ340, P114CB6X4HZ340	03.98 -		8631.47.00	HHISZ-4	- Engine code: K402-5 - Engine code: K432-15 - Engine code: K432-16 - Engine code: K432-17 - Engine code: K432-19 - Engine code: K442-3
114 C/340 R114CA4X2HZ340, P114CA4X2HZ340	03.98 -				
114 C/340 P114CA6X4HZ340, R114CA6X4HZ340	03.98 -				
114 C/380, 4x2	03.98 -		4333.30.00	430 24	- Engine code: K432-13 - Engine code: K432-15 - Engine code: K432-17 - Engine code: K432-30 - Engine code: K432-32 - Engine code: K432-31
114 C/380, 4x4	03.98 -			430WGTZ	
114 C/380, 6x4	03.98 -				
114 C/380, 6x6	03.98 -				
114 C/380, 8x4/4	03.98 -				
114 C/380 P114CB6X4HZ380, P114CB6X4NZ380	03.98 -		4313.20.00	430	- Engine code: K432-15 - Engine code: K432-17 - Engine code: K432-30 - Engine code: K432-31 - Engine code: K432-32
114 C/380 R114CA4X2HZ380, P114CA4X2HZ380, 4x2	03.98 -			MFZ430	
114 C/380 R114CA6X4HZ380, P114CA6X4HZ380, 6x4	03.98 -				
T 94 C/310, 6x4	09.96 -		8934.40.00	KZISZ - 5	- Engine code: K432-30 - Engine code: K432-31 - Engine code: K432-32 - Engine code: K432-33
T 94 C/310, Platform/Chassis, 4x2	09.96 -				
T 94 C/310, 6x4	09.96 -				
T 94 G/220, Platform/Chassis, 4x2	08.96 -		4313.26.00	430	
T 94 G/220, 6x2	08.96 -			MFZ430	
T 94 G/220, Truck Tractor, 4x2	08.96 -				
T 94 G/230, Platform/Chassis, 4x2	04.99 -				
T 94 G/230, 6x2	04.99 -				
T 94 G/230, Truck Tractor, 4x2	04.99 -				
T 94 G/260, Platform/Chassis, 4x2	12.96 -				
T 94 G/260, 6x2	12.96 -				
T 94 G/260, 6x4	12.96 -				
T 94 G/260, Truck Tractor, 4x2	12.96 -				
T 94 G/310, Platform/Chassis, 4x2	12.96 -				
T 94 G/310, 6x4	09.96 -				
T 94 G/310, 6x2	12.96 -				

Vehicle list

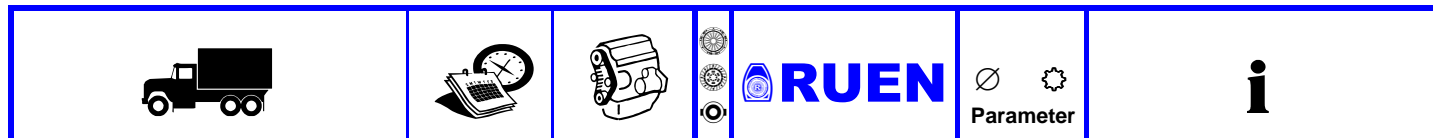

SCANIA

4 - series 09.95 - 09.04

114 G/340 P114GB4X2NA340, R114GB4X2NA340, P114GB4X2NZ340, R114GB4X2NZ340, P114GB4X2NB340	05.96 -	DC 11.01		4300.50.09	430 24	- Engine code: K432-16
114 G/340, 6x2/4	05.96 -	DC 11.02		4328.20.00	MFZ430	
114 G/340, 6x4	05.96 -	DC 11.03		4333.30.00	430WGTZ	
114 G/340, 8x2/4	05.96 -	DC 11.04		4300.90.09	430 24	- Engine code: K432-16
114 G/340, 8x4/4	05.96 -	DSC 11.07		4328.20.00	MFZ430	
114 G/340 R114GA4X2NA340, P114GA4X2NA340, R114GA4X2NZ340, P114GA4X2NZ340	05.96 -	DSC 11.79		4333.30.00	430WGTZ	
114 G/340, 6x2	05.96 -			8631.47.00	HHISZ-4	
114 G/340, 6x4	05.96 -			4300.90.114	430 24	- Engine code: K432-19
114 G/340 P114GB4X2NA340, R114GB4X2NA340, P114GB4X2NZ340, R114GB4X2NZ340, P114GB4X2NB340, R114GB4X2NB340	03.98 -			4378.20.00	MFZ430	
114 G/340, Platform/Chassis, 6x2/4	03.98 -			4393.30.00	430WGTZ	
114 G/340, Platform/Chassis, 6x4	03.98 -			4300.90.113	430 24	- Engine code: K432-33
114 G/340, Platform/Chassis, 8x2/4	03.98 -			4393.20.00	MFZ430	
114 G/340, Platform/Chassis, 8x2/6	03.98 -			4393.30.00	430WGTZ	
114 G/340, Platform/Chassis, 8x4/4	03.98 -			8934.40.00	KZISZ - 5	
114 G/340, Truck Tractor, 6x2	03.98 -			4051.30.00	400 24	- Engine code: K402-4
114 G/340, Truck Tractor, 6x4	03.98 -			8631.47.00	HHISZ-4	- Engine code: K402-5
114 G/380, 6x2/4	03.98 -					- Engine code: K432-15
114 G/380, 6x4	03.98 -					- Engine code: K432-16
114 G/380, 8x2/4	03.98 -					- Engine code: K432-17
114 G/380, 8x4/4	03.98 -					- Engine code: K432-19
114 G/380 R114GA4X2NZ380, P114GA4X2NA380, P114GA4X2NZ380, R114GA4X2NA380	03.98 -					- Engine code: K412-3
114 G/380, Truck Tractor, 6x2	03.98 -			4333.30.00	430 24	- Engine code: K432-13
114 G/380 P114GA6X4NZ380	03.98 -				430WGTZ	- Engine code: K432-15
114 L/340 R114LB4X2NA340, P114LB4X2NB340, P114LB4X2NA340, P114LB4X2LB340, R114LB4X2LB340	05.96 -					- Engine code: K432-17
114 L/340, Platform/Chassis, 6x2/4	05.96 -					- Engine code: K432-30
114 L/340 R114LA4X2NA340, R114LA4X2LA340, P114LA4X2LA340, P114LA4X2NA340, R114LA4X2EB340	05.96 -					- Engine code: K432-32
114 L/340 P114LA6X2/4NA340, R114LA6X2/4NA340, 6x2/4	05.96 -					- Engine code: K432-31
114 L/340, Truck Tractor, 6x4	05.96 -					- Engine code: K432-32
114 L/340 R114LB4X2NA340, P114LB4X2NB340, P114LB4X2NA340, P114LB4X2LB340, R114LB4X2LB340	03.98 -					- Engine code: K432-33
114 L/340, Platform/Chassis, 6x2/4	03.98 -					
114 L/340 P114LA4X2NB340, R114LA4X2NA340, R114LA4X2NB340, R114LA4X2LA340, P114LA4X2LA340, P114LA4X2LB340, P114LA4X2NA340	03.98 -					
114 L/340 P114LA6X2/4NA340, R114LA6X2/4NA340	03.98 -					
114 L/340, Truck Tractor, 6x4	03.98 -					
114 L/380, Platform/Chassis, 6x2/4	03.98 -					
114 L/380 P114LA4X2LA380, P114LA4X2LB380, R114LA4X2LB380, R114LA4X2LA380, R114LA4X2NA380, R114LA4X2NB380, P114LA4X2NA380	03.98 -					
114 L/380 P114LA6X2/4NA380, R114LA6X2/4NA380	03.98 -					
114 L/380, 6x4	03.98 -					

Vehicle list

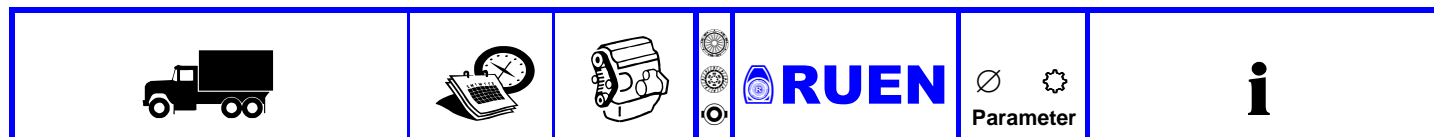

SCANIA

4 - series 09.95 - 09.04

124 C/360, 18.00t, Dump Truck, 4x2	09.96 -	DC 11.01	4300.50.09	430 24	- Engine code: K432-16
124 C/360, 18.00t, Dump Truck, 4x4	09.96 -	DC 11.02	4328.20.00	MFZ430	
124 C/360, 26.00t, Dump Truck, 6x4	09.96 -	DC 11.03	4333.30.00	430WGTZ	
124 C/360, 26.00t, Dump Truck, 6x6	09.96 -	DC 11.04	4300.90.09	430 24	- Engine code: K432-16
124 C/360, 32.00t, Dump Truck, 8x4/4	09.96 -	DSC 11.79	4328.20.00	MFZ430	
124 C/360 P124CB4X2HZ360	09.96 -	DSC 12.01	4333.30.00	430WGTZ	
124 C/360 P124CB6X4NZ360, P124CB6X4HZ360	09.96 -	DSC 12.02	8631.47.00	HHISZ-4	
124 C/360, 18.00t, Truck Tractor, 4x2	09.96 -		4300.90.114	430 24	- Engine code: K432-19
124 C/360, 26.00t, Truck Tractor, 6x4	09.96 -		4378.20.00	MFZ430	
124 C/400, 18.00t, Dump Truck, 4x2	09.96 -		4393.30.00	430WGTZ	
124 C/400, 18.00t, Dump Truck, 4x4	09.96 -		4300.90.113	430 24	- Engine code: K432-33
124 C/400, 26.00t, Dump Truck, 6x4	09.96 -		4393.20.00	MFZ430	
124 C/400, 26.00t, Dump Truck, 6x6	09.96 -		4393.30.00	430WGTZ	
124 C/400, 26.00t, Dump Truck, 6x6	09.96 -		8934.40.00	KZISZ - 5	
124 C/400, 32.00t, Dump Truck, 8x4/4	09.96 -		4051.30.00	400 24	- Engine code: K402-4
124 C/400, 18.00t, Platform/Chassis, 4x4	09.96 -		8631.47.00	HHISZ-4	- Engine code: K402-5
124 C/400, 26.00t, Platform/Chassis, 6x4	09.96 -				- Engine code: K432-15
124 C/400, 18.00t, Truck Tractor, 4x2	09.96 -				- Engine code: K432-16
124 C/400, 26.00t, Truck Tractor, 6x4	09.96 -				- Engine code: K432-17
T 114 C/340T114CB6X4HZ340	03.98 -				- Engine code: K432-19
T 114 C/340 T114CB6X4HZ340, 10600cc	03.98 -		4333.30.00	430 24	- Engine code: K442-3
T 114 C/340, Platform/Chassis, 4x2	03.98 -			430WGTZ	- Engine code: K432-13
T 114 C/340 T114CB6X4HZ340	03.98 -				- Engine code: K432-15
T 114 C/340, Truck Tractor, 4x2	03.98 -				- Engine code: K432-17
T 114 C/380, 6x4	03.98 -				- Engine code: K432-30
T 114 C/380, Platform/Chassis, 4x2	03.98 -		4313.20.00	430	- Engine code: K432-32
T 114 C/380 T114CB6X4HZ380	03.98 -			MFZ430	- Engine code: K432-15
T 114 C/380 T114CA6X4HZ380	03.98 -				- Engine code: K432-17
T 114 G/340, Platform/Chassis, 4x2	05.96 -				- Engine code: K432-30
T 114 G/340, Platform/Chassis, 6x2	05.96 -		8934.40.00	KZISZ - 5	- Engine code: K432-31
T 114 G/340, Platform/Chassis, 6x4	05.96 -				- Engine code: K432-32
T 114 G/340, Truck Tractor, 4x2	05.96 -				- Engine code: K432-33
T 114 G/340, 6x2	05.96 -		4313.26.00	430	
T 114 G/340, 6x4	05.96 -			MFZ430	
T 114 G/340, Platform/Chassis, 4x2	03.98 -				
T 114 G/340, Platform/Chassis, 6x2	03.98 -				
T 114 G/340, 6x4	03.98 -				
T 114 G/340, Truck Tractor, 4x2	03.98 -				
T 114 G/340, Truck Tractor, 6x2	03.98 -				
T 114 G/380, Platform/Chassis, 4x2	03.98 -				
T 114 G/380, Platform/Chassis, 6x2	03.98 -				
T 114 G/380, Platform/Chassis, 6x4	03.98 -				
T 114 G/380, Truck Tractor, 6x2	03.98 -				
T 114 G/380, Truck Tractor, 6x4	03.98 -				
T 114 L/340 T114LA4X2NA340	05.96 -				
T 114 L/340 T114LA4X2LB340, T114LA4X2LA340, T114LA4X2NA340, T114LA4X2NB340	03.98 -				
T 114 L/340	03.98 -				
T 114 L/380, 6x2	03.98 -				
T 114 L/380, 6x4	03.98 -				

Vehicle list



SCANIA

4 - series 09.95 - 09.04

124 G/360, Platform/Chassis, 4x2	05.96 -	DC 12.01		4300.50.09	430 24	- Engine code: K432-16
124 G/360, Platform/Chassis, 6x2	05.96 -	DC 12.03		4328.20.00	MFZ430	
124 G/360, Platform/Chassis, 6x4	05.96 -	DSC 12.01		4333.30.00	430WGTZ	
124 G/360, Platform/Chassis, 8x2/4	05.96 -	DSC 12.02		4300.90.09	430 24	- Engine code: K432-16
124 G/360, Platform/Chassis, 8x4/4	05.96 -	DSC 12.05		4328.20.00	MFZ430	
124 G/360, Truck Tractor, 4x2	05.96 -	DT 12.08		4333.30.00	430WGTZ	
124 G/360, Truck Tractor, 6x2	05.96 -			8631.47.00	HHISZ-4	
124 G/360, Truck Tractor, 6x4	05.96 -			4300.90.114	430 24	- Engine code: K432-19
124 G/400, Platform/Chassis, 6x2	05.96 -			4378.20.00	MFZ430	
124 G/400, Platform/Chassis, 6x4	05.96 -			4393.30.00	430WGTZ	
124 G/400, Platform/Chassis, 8x2/4	05.96 -			4300.90.113	430 24	- Engine code: K432-33
124 G/400, Truck Tractor, 4x2	05.96 -			4393.20.00	MFZ430	
124 G/400, Truck Tractor, 6x2	05.96 -			4393.30.00	430WGTZ	
124 G/400, Truck Tractor, 6x4	05.96 -			8934.40.00	KZISZ - 5	
124 L/360, Platform/Chassis, 4x2	09.96 -			4051.30.00	400 24	- Engine code: K402-4
124 L/360, Platform/Chassis, 6x2	09.96 -				400WGVZ	
124 L/360, Platform/Chassis, 6x4	09.96 -			8631.47.00	HHISZ-4	- Engine code: K402-5
124 L/360, Truck Tractor, 4x2	09.96 -					- Engine code: K432-15
124 L/360, Truck Tractor, 6x2	09.96 -					- Engine code: K432-16
124 L/360, Truck Tractor, 6x4	09.96 -					- Engine code: K432-17
124 L/400, Platform/Chassis, 4x2	09.96 -					- Engine code: K432-19
124 L/400, Platform/Chassis, 6x2	09.96 -					- Engine code: K442-3
124 L/400, Platform/Chassis, 6x4	09.96 -			4333.30.00	430 24	- Engine code: K432-13
124 L/400, Truck Tractor, 4x2	09.96 -				430WGTZ	- Engine code: K432-15
124 L/400, Truck Tractor, 6x2	09.96 -					- Engine code: K432-17
124 L/400, Truck Tractor, 6x4	09.96 -					- Engine code: K432-30
124 L/420 R124LA6X2NA420, P124LA6X2NA420	05.96 -			4313.20.00	430	- Engine code: K432-15
124 L/420 P124LB4X2LB420, R124LB4X2LB420, P124LB4X2NA420, R124LB4X2NB420, P124LB4X2NB420, R124LB4X2NA420	09.97 -				MFZ430	- Engine code: K432-17
124 L/420, 6x2	09.97 -			8934.40.00	KZISZ - 5	- Engine code: K432-30
124 L/420, 6x4	09.97 -					- Engine code: K432-31
124 L/420 R124LA4X2NB420, R124LA4X2NA420, P124LA4X2NA420, R124LA4X2LB420, P124LA4X2LB420, P124LA4X2NB420, R124LA4X2EB420	09.97 -			4313.26.00	430	- Engine code: K432-32
124 L/420, Truck Tractor, 6x4	09.97 -				MFZ430	- Engine code: K432-33
124 L/440, Platform/Chassis, 4x2	01.01 -					
124 L/440, Platform/Chassis, 6x2	01.01 -					
124 L/440, Truck Tractor, 4x2	01.01 -					
124 L/440, Truck Tractor, 6x2	01.01 -					

Vehicle list



SCANIA

4 - series 09.95 - 09.04

124 L/470 R124LB4X2NB470, P124LB4X2NA470, P124LB4X2NB470, R124LB4X2NA470	01.01 -	DSC 12.01 DSC 12.02 DT 12.02	4300.50.09 4328.20.00 4333.30.00	430 24 MFZ430 430WGTZ	- Engine code: K432-16
124 L/470, Platform/Chassis, 6x2	01.01 -		4300.90.09 4328.20.00 4333.30.00 8631.47.00	430 24 MFZ430 430WGTZ HHISZ-4	- Engine code: K432-16
124 L/470, Truck Tractor, 6x2	01.01 -				
T 124 C/360, 6x4	09.95 -				
T 124 C/360, Platform/Chassis, 4x2	09.95 -				
T 124 C/360 T124CB6X4HZ360	09.95 -				
T 124 C/360, Truck Tractor, 4x2	09.95 -		4300.90.114 4378.20.00 4393.30.00	430 24 MFZ430 430WGTZ	- Engine code: K432-19
T 124 C/360 T124CB6X4HZ360	09.95 -				
T 124 C/400, Dump Truck, 6x4	05.96 -				
T 124 C/400, Platform/Chassis, 4x2	05.96 -		4300.90.113 4393.20.00 4393.30.00 8934.40.00	430 24 MFZ430 430WGTZ KZISZ - 5	- Engine code: K432-33
T 124 C/400, Platform/Chassis, 6x4	05.96 -				
T 124 C/400, Truck Tractor, 4x2	05.96 -				
T 124 C/400, Truck Tractor, 6x4	05.96 -		4051.30.00	400 24 400WGVZ	- Engine code: K402-4
			8631.47.00	HHISZ-4	- Engine code: K402-5 - Engine code: K432-15 - Engine code: K432-16 - Engine code: K432-17 - Engine code: K432-19 - Engine code: K442-3
			4333.30.00	430 24 430WGTZ	- Engine code: K432-13 - Engine code: K432-15 - Engine code: K432-17 - Engine code: K432-30 - Engine code: K432-32 - Engine code: K432-31
			4313.20.00	430 MFZ430	
			8934.40.00	KZISZ - 5	
			4313.26.00	430 MFZ430	

Vehicle list



SCANIA

4 - series 09.95 - 09.04

144 C/460, 6x4	09.96 -	DC 12.01		4300.50.09	430 24	- Engine code: K432-16
144 C/460, 8x4/4	09.96 -	DC 12.03		4328.20.00	MFZ430	
144 C/460, Platform/Chassis, 4x2	09.96 -	DSC 12.01		4333.30.00	430WGTZ	
144 C/460, Platform/Chassis, 6x4	09.96 -	DSC 12.02		4300.90.09	430 24	- Engine code: K432-16
144 C/460, Truck Tractor, 4x2	09.96 -	DSC 12.05		4328.20.00	MFZ430	
144 C/460, Truck Tractor, 6x4	09.96 -	DSC 14.13		4333.30.00	430WGTZ	
144 C/530, Dump Truck, 6x4	09.96 -	DSC 14.15		8631.47.00	HHISZ-4	
144 C/530, Dump Truck, 8x4/4	09.96 -			4300.90.114	430 24	- Engine code: K432-19
144 C/530, Platform/Chassis, 6x4	09.96 -			4378.20.00	MFZ430	
144 C/530, Truck Tractor, 4x2	09.96 -			4393.30.00	430WGTZ	
144 C/530, Truck Tractor, 6x4	09.96 -			4300.90.113	430 24	- Engine code: K432-33
144 G/460 R144GB4X2NB460, R144GB4X2NA460, R144GB4X2NZ460	04.96 -			4393.20.00	MFZ430	
144 G/460 R144GB6X2NZ460	04.96 -			4393.30.00	430WGTZ	
144 G/460 R144GB6X4NB460, R144GB6X4NZ460, R144GB6X4NA460	04.96 -			8934.40.00	KZISZ - 5	
144 G/460, 8x2/4	04.96 -			4051.30.00	400 24	- Engine code: K402-4
144 G/460, 8x4/4	04.96 -			8631.47.00	HHISZ-4	- Engine code: K402-5
144 G/460 R144GA4X2NZ460, R144GA4X2NA460	04.96 -					- Engine code: K432-15
144 G/460, 6x2	04.96 -					- Engine code: K432-16
144 G/460 R144GA6X4NA460, R144GA6X4NZ460	04.96 -					- Engine code: K432-17
T 124 C/420, 6x4	05.96 -					- Engine code: K432-19
T 124 C/420, Platform/Chassis, 4x2	05.96 -					- Engine code: K442-3
T 124 C/420 T124CB6X4HZ420	05.96 -					
T 124 C/420 T124CA6X4HZ420	09.97 -					
T 124 G/360, Platform/Chassis, 4x2	03.97 -					
T 124 G/360, Platform/Chassis, 6x2	03.97 -					
T 124 G/360, Platform/Chassis, 6x4	03.97 -					
T 124 G/360, Truck Tractor, 4x2	03.97 -					
T 124 G/360, Truck Tractor, 6x2	03.97 -					
T 124 G/360, Truck Tractor, 6x4	03.97 -					
T 124 G/400, Platform/Chassis, 4x2	03.97 -					
T 124 G/400, Platform/Chassis, 6x2	03.97 -					
T 124 G/400, Platform/Chassis, 6x4	03.97 -					
T 124 G/400, Truck Tractor, 4x2	03.97 -					
T 124 G/400, Truck Tractor, 6x2	03.97 -					
T 124 G/400, Truck Tractor, 6x4	03.97 -					
T 124 G/420	05.96 -					
T 124 G/420, Platform/Chassis, 4x2	09.97 -					
T 124 G/420, 6x2	09.97 -					
T 124 G/420, 6x4	09.97 -					
T 124 L/360	05.95 -					
T 124 L/360, Truck Tractor, 6x4	09.95 -					
T 124 L/360, Truck Tractor, 4x2	02.97 -					
T 124 L/400, 6x2	05.96 -					
T 124 L/400, 6x4	05.96 -					
T 124 L/400	02.97 -					
T 124 L/420	05.96 -					
T 124 L/420, 6x2	09.97 -					
T 124 L/420, 6x4	09.97 -					

Vehicle list

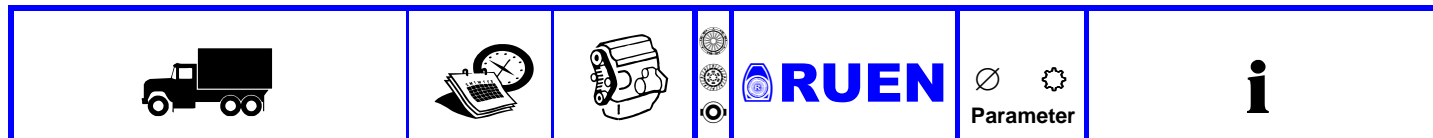

SCANIA

4 - series 09.95 - 09.04

144 G/530 R144GB6X2NZ530	04.96 -	DSC 14.13		4300.50.09	430 24	- Engine code: K432-16
144 G/530 R144GB6X4NZ530, R144GB6X4NB530, R144GB6X4NA530	04.96 -	DSC 14.15		4328.20.00 4333.30.00	MFZ430 430WGTZ	
144 G/530, 8x2/4	04.96 -			4300.90.09	430 24	- Engine code: K432-16
144 G/530, 8x4/4	04.96 -			4328.20.00 4333.30.00 8631.47.00	MFZ430 430WGTZ HHISZ-4	
144 G/530 R144GA4X2NZ530, R144GA4X2NA530	04.96 -			4300.90.114	430 24	- Engine code: K432-19
144 G/530, 6x2	04.96 -			4378.20.00 4393.30.00	MFZ430 430WGTZ	
144 G/530 R144GA6X4NZ530, R144GA6X4NA530	04.96 -			4300.90.113	430 24	- Engine code: K432-33
144 L/460 R144LB4X2NB460, R144LB4X2NA460	11.95 -			4393.20.00 4393.30.00 8934.40.00	MFZ430 430WGTZ KZISZ - 5	
144 L/460, 6x2	11.95 -			4051.30.00	400 24	- Engine code: K402-4
144 L/460, Platform/Chassis, 6x4	11.95 -			8631.47.00	HHISZ-4	- Engine code: K402-5 - Engine code: K432-15 - Engine code: K432-16 - Engine code: K432-17 - Engine code: K432-19 - Engine code: K442-3
144 L/460 R144LA4X2LB460, R144LA4X2NB460, R144LA4X2LA460, R144LA4X2NA460	11.95 -			4333.30.00	430 24	- Engine code: K432-13 - Engine code: K432-15 - Engine code: K432-17 - Engine code: K432-30 - Engine code: K432-32 - Engine code: K432-31
144 L/460, Truck Tractor, 6x2/4	11.95 -				430WGTZ	
144 L/460, Truck Tractor, 6x4	11.95 -					
144 L/530, 6x2	11.95 -					
144 L/530, Platform/Chassis, 6x4	11.95 -					
144 L/530 R144LA4X2NA530, R144LA4X2NB530, R144LA4X2LA530, R144LA4X2LB530	11.95 -					
144 L/530, Truck Tractor, 6x2/4	11.95 -					
144 L/530, Truck Tractor, 6x4	11.95 -					
T 144 C/460, Platform/Chassis, 4x2	09.95 -					
T 144 C/460, Platform/Chassis, 6x4	09.95 -					
T 144 C/460, Truck Tractor, 4x2	09.95 -					
T 144 C/460, Truck Tractor, 6x4	09.95 -					
T 144 C/530, Platform/Chassis, 4x2	09.95 -					
T 144 C/530, Platform/Chassis, 6x4	09.95 -					
T 144 C/530, Truck Tractor, 6x4	09.95 -					
T 144 G/460, Platform/Chassis, 4x2	03.97 -			4313.20.00	430	- Engine code: K432-15 - Engine code: K432-17 - Engine code: K432-30 - Engine code: K432-31 - Engine code: K432-32
T 144 G/460, Platform/Chassis, 6x2	03.97 -				MFZ430	
T 144 G/460, Platform/Chassis, 6x4	03.97 -					
T 144 G/460, Truck Tractor, 4x2	03.97 -			8934.40.00	KZISZ - 5	- Engine code: K432-30 - Engine code: K432-31 - Engine code: K432-32 - Engine code: K432-33
T 144 G/460, Truck Tractor, 6x2	03.97 -					
T 144 G/460, Truck Tractor, 6x4	03.97 -					
T 144 G/530, Platform/Chassis, 6x2	03.97 -					
T 144 G/530, Platform/Chassis, 6x4	03.97 -					
T 144 G/530, Truck Tractor, 4x2	03.97 -					
T 144 G/530, Truck Tractor, 6x2	03.97 -					
T 144 G/530, Truck Tractor, 6x4	03.97 -					
T 144 L/460, 6x2	09.95 -					
T 144 L/460, 6x4	09.95 -					
T 144 L/460, 4x2	03.97 -					
T 144 L/530, 6x2	09.95 -					
T 144 L/530, 6x4	09.95 -					

Vehicle list



SCANIA

4 - series 09.95 - 09.04

94 /G260 P94GB6X2*4NB260, P94GB6X2*4NA260	08.96 -	DC 16.01		4300.50.09	430 24	- Engine code: K432-16
94 C/300 P94CB6X4HZ300	08.96 -	DC 16.02		4328.20.00	MFZ430	
94 C/310, Platform/Chassis, 6x4	01.05 -	DC 9.01		4333.30.00	430WGTZ	
94 D/220, 6x2	08.96 -	DC 9.02		4300.90.09	430 24	- Engine code: K432-16
94 D/220 P94DB6X2*4LB220, P94DB6X2*4NB220,	08.96 -	DC 9.03		4328.20.00	MFZ430	
P94DB6X2*4LA220, P94DB6X2*4NA220	08.96 -	DC 9.04		4333.30.00	430WGTZ	
94 D/220 P94DA4X2LZ220, P94DA4X2NZ220, P94DA4X2NA220, P94DA4X2LA220, P94DA4X2LB220, P94DA4X2NB220	08.96 -	DC 9.05		8631.47.00	HHISZ-4	
94 D/230 P94DB4X2NZ230, 4x2	04.99 -	DC 9.21		4300.90.114	430 24	- Engine code: K432-19
94 D/230 P94DB6X2NA230, 6x2	04.99 -	DSC 9.11		4378.20.00	MFZ430	
94 D/230, 6x2	08.99 -	DSC 9.12		4393.30.00	430WGTZ	
164 C/480, Dump Truck, 4x2	05.00 -			4300.90.113	430 24	- Engine code: K432-33
164 C/480, Dump Truck, 4x4	05.00 -			4393.20.00	MFZ430	
164 C/480, Dump Truck, 6x4	05.00 -			4393.30.00	430WGTZ	
164 C/480, Dump Truck, 6x6	05.00 -			8934.40.00	KZISZ - 5	
164 C/480, Dump Truck, 8x4/4	05.00 -			4051.30.00	400 24	- Engine code: K402-4
164 C/480, Platform/Chassis, 4x2	05.00 -			8631.47.00	HHISZ-4	- Engine code: K402-5
164 C/480, Platform/Chassis, 4x4	05.00 -					- Engine code: K432-15
164 C/480, Platform/Chassis, 6x4	05.00 -					- Engine code: K432-16
164 C/480, Truck Tractor, 4x2	05.00 -					- Engine code: K432-17
164 C/480, Truck Tractor, 4x4	05.00 -					- Engine code: K432-19
164 C/480 P164CA6X4HZ480, R164CA6X4HZ480	05.00 -					- Engine code: K442-3
164 C/580, Platform/Chassis, 6x6	05.00 -			4333.30.00	430 24	- Engine code: K432-13
164 C/580, Truck Tractor, 4x2	05.00 -				430WGTZ	- Engine code: K432-15
164 C/580 R164CA6X4HZ580, P164CA6X4HZ580	05.00 -					- Engine code: K432-17
164 G/480 R164GB4X2NZ480, R164GB4X2NB480, R164GB4X2NA480	05.00 -					- Engine code: K432-30
164 G/480 R164GB6X2NZ480	05.00 -					- Engine code: K432-32
164 G/480 R164GA4X2NZ480, R164GA4X2NA480	05.00 -					- Engine code: K432-31
164 G/580 R164GB6X2NZ580	05.00 -					- Engine code: K432-32
164 G/580 R164GA4X2NA580, R164GA4X2NZ580	05.00 -			4313.20.00	430	- Engine code: K432-15
164 G/580	05.00 -				MFZ430	- Engine code: K432-17
164 G/580 R164GA6X4NZ580, R164GA6X4NA580	05.00 -					- Engine code: K432-30
164 L/480 R164LB4X2NA480, R164LB4X2NB480	05.00 -					- Engine code: K432-31
164 L/480 R164LA6X2NA480, R164LB6X2NB480, R164LB6X2NA480	05.00 -					- Engine code: K432-32
164 L/480, Platform/Chassis, 6x4	05.00 -					- Engine code: K432-33
164 L/480 R164LA4X2NA480, R164LA4X2NB480, R164LA4X2LB480, R164LA4X2LA480	05.00 -			8934.40.00	KZISZ - 5	
164 L/480 R164LA6X2/4NA480	05.00 -					
164 L/480, Truck Tractor, 6x4	05.00 -			4313.26.00	430	
164 L/580 R164LB6X2NA580, R164LB6X2NB580	05.00 -				MFZ430	
164 L/580, Platform/Chassis, 6x4	05.00 -					
164 L/580 R164LA4X2LA580, R164LA4X2NA580, R164LA4X2NB580, R164LA4X2LB580	05.00 -					
164 L/580 R164LA6X2/4NA580, 6x2	05.00 -					
164 L/580, Truck Tractor, 6x4	05.00 -					

Vehicle list



SCANIA

4 - series 09.95 - 09.04

94 D/220 P94DB4X2LZ220, P94DB4X2NZ220, P94DB4X2LA220, P94DB4X2LB220, P94DB4X2NA220, P94DB4X2NB220	08.96 -	DC 11.01 DC 11.03 DC 11.07	4300.50.09 4328.20.00 4333.30.00	430 24 MFZ430 430WGTZ	- Engine code: K432-16
94 D/220, 4x2	08.96 -	DC 9.02	4300.90.09	430 24	- Engine code: K432-16
94 D/260 P94DB4X2NZ260	08.96 -	DC 9.03	4328.20.00	MFZ430	
94 D/260, 6x2	08.96 -	DC 9.05	4333.30.00	430WGTZ	
94 D/260 P94DB6X2NA260	08.96 -	DC 9.06	8631.47.00	HHISZ-4	
94 D/260 P94DB6X2*4NB260, P94DB6X2*4LB260, P94DB6X2*4NA260, P94DB6X2*4LA260	08.96 -	DC 9.20 DC 9.21	4300.90.114 4378.20.00 4393.30.00	430 24 MFZ430 430WGTZ	- Engine code: K432-19
94 D/260 P94DA4X2LB260, P94DA4X2NB260, P94DA4X2NZ260, P94DA4X2LZ260, P94DA4X2NA260, P94DA4X2LA260	08.96 -	DSC 11.07 DSC 11.79 DSC 9.11 DSC 9.12 DSC 9.13 DSC 9.15	4300.90.113 4393.20.00 4393.30.00 8934.40.00	430 24 MFZ430 430WGTZ KZISZ - 5	- Engine code: K432-33
94 D/270 P94DB6X2NA270	08.96 -		4051.30.00	400 24 400WGVZ	- Engine code: K402-4
94 D/300 P94DB4X2NZ300	08.96 -		8631.47.00	HHISZ-4	- Engine code: K402-5 - Engine code: K432-15 - Engine code: K432-16 - Engine code: K432-17 - Engine code: K432-19 - Engine code: K442-3
94 D/300	08.96 -				
94 D/300 P94DB6X2NA300	08.96 -				
94 D/300 P94DB6X2*4NA300	08.96 -				
94 D/300 P94DA4X2NA300, P94DB4X2NZ300	08.96 -				
94 D/310 P94DA4X2NZ310, P94DA4X2NA310, P94DA4X2LA310, P94DA4X2LB310, P94DA4X2NB310, P94DA4X2LZ310	08.96 -		4333.30.00	430 24 430WGTZ	- Engine code: K432-13 - Engine code: K432-15 - Engine code: K432-17 - Engine code: K432-30 - Engine code: K432-32 - Engine code: K432-31
94 D/310, 6x2	01.98 -				
94 D/310, 6x2/4	01.98 -				
94 G/220, 6x2	01.98 -		4313.20.00	430 MFZ430	- Engine code: K432-15 - Engine code: K432-17 - Engine code: K432-30 - Engine code: K432-31 - Engine code: K432-32
94 G/260 P94GB6X2NZ260	08.96 -				
94 G/260, 6x2	01.98 -				
94 G/300	01.04 -				
94 G/310, 6x2	08.96 -				
94 G/310 P94GB6X2NZ310	08.96 -		8934.40.00	KZISZ - 5	- Engine code: K432-30 - Engine code: K432-31 - Engine code: K432-32 - Engine code: K432-33
94 G/310 P94GB6X2*4NB310, P94GB6X2*4NA310	08.96 -				
94 G/310 P94GB6X4NB310, P94GB6X4NZ310, P94GB6X4NA310	08.96 -		4313.26.00	430 MFZ430	
94 L/310, Platform/Chassis, 6x2	08.96 -				
94 L/310 P94LB6X2*4NB310, P94LB6X2*4LB310, P94LB6X2*4LA310, P94LB6X2*4NA310	08.96 -				
114 C/330 P114CB6X4HZ330	05.96 -				
114 C/340 P114CB6X4HZ340, 6x4	05.96 -				
114 C/340 P114CB8X4HZ340, 11000cc, 8x4	05.96 -				
114 C/340 P114CB8X4HZ340, 10600cc, 8x4	05.96 -				
114 C/340 P114CB8X4NZ340, P114CB8X4HZ340, 11000cc	05.96 -				
114 C/340 P114CB8X4NZ340, P114CB8X4HZ340, 10600cc	05.96 -				
114 C/340 R114CB4X4HZ340, P114CB4X4HZ340, 4x4	05.96 -				
114 C/340 R114CB6X6HZ340, P114CB6X6HZ340, 6x6	05.96 -				
114 C/340 P114CB8X4NZ340, P114CB8X4HZ340, R114CB8X4HZ340, 10600cc, 8x4	05.96 -				
114 C/340 P114CB8X4NZ340, P114CB8X4HZ340, R114CB8X4HZ340, 11000cc, 8x4	05.96 -				

Vehicle list



SCANIA

4 - series 09.95 - 09.04

114 C/340 R114CA4X4HA340, P114CA4X4HZ340, P114CA4X4HA340, R114CA4X4HZ340	05.96 -	DC 11.01 DC 11.02 DC 11.03	4300.50.09 4328.20.00 4333.30.00	430 24 MFZ430 430WGTZ	- Engine code: K432-16
114 C/360	01.00 -	DC 11.04	4300.90.09 4328.20.00 4333.30.00 8631.47.00	430 24 MFZ430 430WGTZ HHISZ-4	- Engine code: K432-16
114 C/380 P114CB6X4HZ380, 6x4	03.98 -	DC 11.07	4300.90.114 4378.20.00 4393.30.00	430 24 MFZ430 430WGTZ	- Engine code: K432-19
114 C/380 P114CB8X4HZ380, Concrete Mixer, 8x4	03.98 -	DSC 11.06 DSC 11.79	4300.90.113 4393.20.00 4393.30.00 8934.40.00	430 24 MFZ430 430WGTZ KZISZ - 5	- Engine code: K432-33
114 C/380 P114CB8X4HZ380, Dump Truck, 8x4	03.98 -		4051.30.00	400 24 400WGVZ	- Engine code: K402-4
114 C/380 P114CB4X4HZ380, R114CB4X4HZ380, Platform/Chassis, 4x4	03.98 -		8631.47.00	HHISZ-4	- Engine code: K402-5 - Engine code: K432-15 - Engine code: K432-16 - Engine code: K432-17 - Engine code: K432-19 - Engine code: K442-3
114 C/380 R114CB6X6HZ380, P114CB6X6HZ380, Platform/Chassis, 6x6	03.98 -		4333.30.00	430 24 430WGTZ	- Engine code: K432-13 - Engine code: K432-15 - Engine code: K432-17 - Engine code: K432-30 - Engine code: K432-32 - Engine code: K432-31
114 C/380 P114CA4X4HA380, R114CA4X4HA380, Truck Tractor, 4x4	03.98 -		4313.20.00	430 MFZ430	- Engine code: K432-15 - Engine code: K432-17 - Engine code: K432-30 - Engine code: K432-31 - Engine code: K432-32
114 C/380 R114CB8X4NZ380, P114CB8X4NZ380, P114CB8X4HZ380, R114CB8X4HZ380, 8x4	03.98 -		8934.40.00	KZISZ - 5	- Engine code: K432-30 - Engine code: K432-31 - Engine code: K432-32 - Engine code: K432-33
114 G/320	01.01 - 08.08		4313.26.00	430 MFZ430	
114 G/330	01.04 -				
114 G/340 P114GB6X2NB340, P114GB6X2NA340, P114GB6X2NZ340, R114GB6X2NZ340	05.96 -				
114 G/340 P114GB6X2NB340, P114GB6X2NA340, P114GB6X2NZ340, R114GB6X2NZ340	05.96 -				
114 G/340 P114GB6X2*4NA340, P114GB6X2*4NB340, 11000cc, 6x2/4	05.96 -				
114 G/340 P114GB6X2*4NA340, P114GB6X2*4NB340, 10600cc, 6x2/4	05.96 -				
114 G/340 P114GB8X2NZ340, 11000cc, 8x2	05.96 -				
114 G/340 P114GB8X2NZ340, 10600cc, 8x2	05.96 -				
114 G/340, 8x2/6	05.96 -				
114 G/340 R114GB8X2*6NA340, R114GB8X2*6NB340, P114GB8X2*6NA340, P114GB8X2*6NB340, 10600cc, 8x2/6	05.96 -				
114 G/340 R114GB8X2*6NA340, R114GB8X2*6NB340, P114GB8X2*6NA340, P114GB8X2*6NB340, 11000cc, 8x2/6	05.96 -				
114 G/340 R114GB8X4NZ340, P114GB8X4NZ340, 11000cc, 8x4	05.96 -				
114 G/340 R114GB8X4NZ340, P114GB8X4NZ340, 10600cc, 8x4	05.96 -				
114 G/340, Platform/Chassis, 6x2	03.98 -				
114 G/340 R114GA4X2NA340, P114GA4X2NA340, R114GA4X2NZ340, P114GA4X2NZ340	03.98 -				
114 G/380 P114GB6X2NB380, P114GB6X2NZ380, P114GB6X2NA380, R114GB6X2NZ380	03.98 -				
114 G/380 P114GB6X2*4NA380, P114GB6X2*4NB380	03.98 -				
114 G/380 P114GB8X2NZ380	03.98 -				
114 G/380 P114GB8X2*6NA380, P114GB8X2*6NB380, R114GB8X2*6NA380, R114GB8X2*6NB380	03.98 -				
114 G/380 R114GB8X4NZ380, P114GB8X4NZ380	03.98 -				

Vehicle list

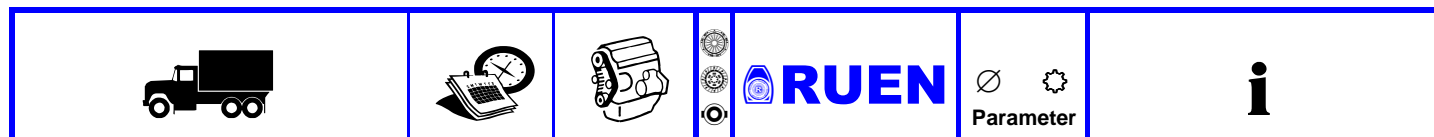

SCANIA

4 - series 09.95 - 09.04

114 G/380, Platform/Chassis, 6x2	03.98 -	DC 11.01	4300.50.09	430 24	- Engine code: K432-16
114 G/380, 8x2/6	03.98 -	DC 11.02	4328.20.00	MFZ430	
114 G/380, Truck Tractor, 4x2	01.05 -	DC 11.03	4333.30.00	430WGTZ	
114 L/340, Platform/Chassis, 6x2	05.96 -	DC 11.04	4300.90.09	430 24	- Engine code: K432-16
114 L/340 P114LB6X2*4LA340,	05.96 -	DC 12.01	4328.20.00	MFZ430	
P114LB6X2*4NB340,		DC 12.02	4333.30.00	430WGTZ	
P114LB6X2*4NA340,		DC 12.03	8631.47.00	HHISZ-4	
R114LB6X2*4LA340,		DC 12.07	4300.90.114	430 24	- Engine code: K432-19
P114LB6X2*4NB340		DC 12.09	4378.20.00	MFZ430	
114 L/340 P114LB6X2*4NA340,	05.96 -	DSC 11.07	4393.30.00	430WGTZ	
P114LB6X2*4NB340,		DSC 11.79	4300.90.113	430 24	- Engine code: K432-33
R114LB6X2*4NA340		DSC 12.02	4393.20.00	MFZ430	
114 L/340 P114LB6X2LB340,	05.96 -	DSC 12.05	4393.30.00	430WGTZ	
P114LB6X2NB340, R114LB6X2NA340,			8934.40.00	KZISZ - 5	
R114LB6X2NB340, R114LB6X2LB340,			4051.30.00	400 24	- Engine code: K402-4
P114LB6X2NA340, 11000cc, 6x2	05.96 -		8631.47.00	HHISZ-4	- Engine code: K402-5
114 L/340 P114LB6X2LB340,	05.96 -				- Engine code: K432-15
P114LB6X2NB340, R114LB6X2NA340,					- Engine code: K432-16
R114LB6X2NB340, R114LB6X2LB340,					- Engine code: K432-17
P114LB6X2NA340, 10600cc, 6x2	05.96 -				- Engine code: K432-19
114 L/340 R114LA6X2NA340, 11000cc,	05.96 -				- Engine code: K442-3
6x2					
114 L/340 R114LA6X2NA340, 10600cc,	05.96 -		4333.30.00	430 24	- Engine code: K432-13
6x2				430WGTZ	- Engine code: K432-15
114 L/340 P114LA6X2/4NA340,	05.96 -				- Engine code: K432-17
R114LA6X2/4NA340, 6x2					- Engine code: K432-30
114 L/340, Platform/Chassis, 6x2	03.98 -				- Engine code: K432-32
114 L/380 P114LB6X2*4NA380,	03.98 -				- Engine code: K432-31
R114LB6X2*4LA380,					
R114LB6X2*4NB380,			4313.20.00	430	- Engine code: K432-15
P114LB6X2*4NB380,				MFZ430	- Engine code: K432-17
P114LB6X2*4LA380,					- Engine code: K432-30
R114LB6X2*4NA380					- Engine code: K432-31
114 L/380 P114LB6X2NB380,	03.98 -				- Engine code: K432-32
P114LB6X2LB380, R114LB6X2NA380,					
R114LB6X2NB380, R114LB6X2LB380,			8934.40.00	KZISZ - 5	- Engine code: K432-30
P114LB6X2NA380					- Engine code: K432-31
114 L/380 R114LA6X2NA380	03.98 -				- Engine code: K432-32
114 L/380, 6x2	01.05 -				- Engine code: K432-33
114 L/380, Platform/Chassis, 6x2	03.98 -		4313.26.00	430	
114 L/380, Truck Tractor, 4x2	03.98 -			MFZ430	
124 /G420 R124GA4X2NZ420,	05.96 -				
R124GA4X2NA420, P124GA4X2NA420,					
P124GA4X2NZ420					
124 C/360 P124CB6X4HZ360	05.96 -				
124 C/360 P124CB8X4HZ360	05.96 -				
124 C/360 R124CB6X6HZ360	05.96 -				
124 C/360 P124CB8X4NZ360,	05.96 -				
P124CB8X4HZ360					
124 C/420 P124CB8X4HZ420	05.96 -				
124 C/420 P124CB4X4HZ420,	05.96 -				
R124CB4X4HZ420					
124 C/420 P124CB4X2HZ420	05.96 -				
124 C/420 P124CB6X4HZ420	05.96 -				
124 C/420 P124CB6X6HZ420,	05.96 -				
R124CB6X6HZ420					
124 C/420 P124CB8X4HZ420,	05.96 -				
P124CB8X4NZ420, R124CB8X4HZ420					
124 C/420 P124CA4X4HZ420,	05.96 -				
R124CA4X2HZ420					

Vehicle list



SCANIA

4 - series 09.95 - 09.04

124 C/420 P124CA4X4HA420, P124CA4X4HZ420, R124CA4X4HA420, R124CA4X4HZ420	05.96 -	DC 12.01 DC 12.03 DSC 12.01	4300.50.09 4328.20.00 4333.30.00	430 24 MFZ430 430WGTZ	- Engine code: K432-16
124 C/420 P124CA6X4HZ420, R124CA6X4HZ420	05.96 -	DSC 12.02	4300.90.09	430 24 MFZ430 430WGTZ	- Engine code: K432-16
124 C/470 P124CB8X4HZ470, R124CB8X4HZ470	01.00 -	DSC 12.05 DSC 14.13	4328.20.00 4333.30.00	430 24 MFZ430 430WGTZ	- Engine code: K432-16
124 C/470 R124CA6X4HZ470, P124CA6X4HZ470	01.00 -	DSC 14.15 DT 12.02	8631.47.00	HHISZ-4	- Engine code: K432-16
124 G/360, Platform/Chassis, 8x2/6	05.96 -	DT 12.08	4300.90.114	430 24 MFZ430 430WGTZ	- Engine code: K432-19
124 G/400, Platform/Chassis, 6x2/4	05.96 -		4378.20.00 4393.30.00	MFZ430 430WGTZ	- Engine code: K432-19
124 G/400, Platform/Chassis, 8x2/6	05.96 -		4300.90.113	430 24 MFZ430 430WGTZ	- Engine code: K432-33
124 G/420 P124GB4X2NA420, P124GB4X2NB420, P124GB4X2NZ420, R124GB4X2NA420, R124GB4X2NB420, R124GB4X2NZ420	05.96 -		4393.20.00 4393.30.00 8934.40.00	MFZ430 430WGTZ KZISZ - 5	- Engine code: K432-33
124 G/420 P124GB6X2NA420, P124GB6X2NZ420, R124GB6X2NZ420, P124GB6X2NB420	05.96 -		4051.30.00	400 24 400WGVZ	- Engine code: K402-4
124 G/420 P124GB6X2*4NA420, P124GB6X2*4NB420	05.96 -		8631.47.00	HHISZ-4	- Engine code: K402-5 - Engine code: K432-15 - Engine code: K432-16 - Engine code: K432-17 - Engine code: K432-19 - Engine code: K442-3
124 G/420 R124GA6X4NZ420	05.96 -				
124 G/420 P124GB8X2NZ420	05.96 -				
124 G/420 P124GB8X2*6NA420, R124GB8X2*6NB420, P124GB8X2*6NB420, R124GB8X2*6NB420	05.96 -		4333.30.00	430 24 430WGTZ	- Engine code: K432-13 - Engine code: K432-15 - Engine code: K432-17 - Engine code: K432-30 - Engine code: K432-32 - Engine code: K432-33
124 G/420 R124GB8X4NZ420	05.96 -				
124 G/420 R124GA6X4NZ420	05.96 -				
124 G/470 R124GA6X4NZ470	01.00 -				
124 G/470 R124GB8X4NZ470	01.00 -		4313.20.00	430 MFZ430	- Engine code: K432-15 - Engine code: K432-17 - Engine code: K432-30 - Engine code: K432-31 - Engine code: K432-32
124 L/360, Platform/Chassis, 6x2/4	09.96 -				
124 L/360, Truck Tractor, 6x2/4	09.96 -				
124 L/400, Platform/Chassis, 6x2/4	09.96 -				
124 L/400, Truck Tractor, 6x2/4	09.96 -		8934.40.00	KZISZ - 5	- Engine code: K432-30 - Engine code: K432-31 - Engine code: K432-32 - Engine code: K432-33
124 L/420 R124LA6X2/4NA420	05.96 -				
124 L/420, 6x2	09.97 -				
124 L/420, 6x2/4	09.97 -				
124 L/420 P124LB6X2NA420, R124LB6X2LB420, R124LB6X2NB420, P124LB6X2LB420, P124LB6X2NB420, R124LB6X2NA420	05.96 -		4313.26.00	430 MFZ430	
124 L/420 R124LB6X2*4LA420, P124LB6X2*4LA420, P124LB6X2*4NB420, R124LB6X2*4LB420, R124LB6X2*4NA420, P124LB6X2*4LB420	05.96 -				
124 L/420, 6x2/4	09.97 -				
124 L/440, Platform/Chassis, 6x2/4	01.01 -				
124 L/440, Truck Tractor, 6x2/4	01.01 -				
124 L/470 R124LA6X2/4NA470	01.00 -				
124 L/470 R124LA6X2NA470	01.00 -				
124 L/470, Platform/Chassis, 6x2/4	01.01 -				
124 L/470, Truck Tractor, 6x2/4	01.01 -				
144 G/460, 8x2/6	04.96 -				
144 G/530, 8x2/6	04.96 -				
144 L/460 R144LB6X2NA460, R144LB6X2NB460	11.95 -				
144 L/460, Platform/Chassis, 6x2/4	11.95 -				

Vehicle list



SCANIA

4 - series 09.95 - 09.04

144 L/530, Platform/Chassis, 6x2/4	11.95 -	DC 11.01		4300.50.09	430 24	- Engine code: K432-16
144 L/530 R144LB6X2NA530, R144LB6X2NB530	01.00 -	DC 11.02		4328.20.00	MFZ430	
164 G/480 R164GB6X4NA480, R164GB6X4NB480, R164GA6X4NZ480	01.00 -	DC 11.03		4333.30.00	430WGTZ	
164 G/480 R164GA6X4NA480, R164GA6X4NA480	01.00 -	DC 11.04		4300.90.09	430 24	- Engine code: K432-16
164 G/580 R164GB6X4NA580, R164GA6X4NZ580, R164GB6X4NB580	01.00 -	DC 12.01		4328.20.00	MFZ430	
164 L/480 R164LA6X2/4NA480	01.00 -	DC 12.03		4333.30.00	430WGTZ	
164 L/480 R164LA6X2/4NA480	01.00 -	DC 16.01		8631.47.00	HHISZ-4	
164 L/480 R164LA6X2/4NA480	01.00 -	DC 16.02		4300.90.114	430 24	- Engine code: K432-19
164 L/480 R164LA6X2/4NA480	01.00 -	DSC 11.79		4378.20.00	MFZ430	
164 L/480 R164LA6X2/4NA480	05.00 -	DSC 12.02		4393.30.00	430WGTZ	
164 L/580 R164LA6X2/4NA580	01.00 -	DSC 12.05		4300.90.113	430 24	- Engine code: K432-33
164 L/580 R164LA6X2/4NA580	01.00 -	DSC 14.13		4393.20.00	MFZ430	
164 L/580 R164LA6X2/4NA580, 6x2/4	01.00 -	DSC 14.15		4393.30.00	430WGTZ	
T 114 C/340 T114CB6X4HZ340	05.96 -	DT 12.02		8934.40.00	KZISZ - 5	
T 114 C/340 T114CA4X2HZ340, 10600cc	05.96 -			4051.30.00	400 24	- Engine code: K402-4
T 114 C/340 T114CA4X2HZ340, 11000cc	05.96 -			8631.47.00	HHISZ-4	- Engine code: K402-5
T 114 C/340 T114CB6X4HZ340, 11000cc	05.96 -					- Engine code: K432-15
T 114 C/340 T114CB6X4HZ340, 10600cc	05.96 -					- Engine code: K432-16
T 114 C/340 T114CA6X4HZ340	05.96 -					- Engine code: K432-17
T 114 C/340 T114CA6X4HZ340	05.96 -					- Engine code: K432-19
T 114 C/340 T114CA6X4HZ340	05.96 -					- Engine code: K442-3
T 114 C/340 T114CA6X4HZ340	05.96 -			4333.30.00	430 24	- Engine code: K432-13
T 114 C/340 T114CB6X4HZ340, 11000cc	03.98 -				430WGTZ	- Engine code: K432-15
T 114 C/380 T114CA4X2HZ380	03.98 -					- Engine code: K432-17
T 114 G/340 T114GA4X2NA340, T114GA4X2NZ340, 11000cc	05.96 -					- Engine code: K432-30
T 114 G/340 T114GA4X2NA340, T114GA4X2NZ340, 10600cc	05.96 -					- Engine code: K432-32
T 114 G/380 T114GA4X2NZ380, T114GA4X2NA380	03.98 -					- Engine code: K432-31
T 114 L/340 T114LA4X2LB340, T114LA4X2LA340, T114LA4X2NA340, T114LA4X2NB340, 11000cc	05.96 -			4313.20.00	430	- Engine code: K432-15
T 114 L/340 T114LA4X2LB340, T114LA4X2LA340, T114LA4X2NA340, T114LA4X2NB340, 10600cc	05.96 -				MFZ430	- Engine code: K432-17
T 114 L/380 T114LA4X2NB380, T114LA4X2NA380, T114LA4X2LA380, T114LA4X2LB380	03.98 -					- Engine code: K432-30
T 124 C/420 T124CA4X2HZ420	05.96 -					- Engine code: K432-31
T 124 G/360	03.98 - 12.05					- Engine code: K432-32
T 124 G/420 T124GA4X2NZ420, T124GA4X2NA420	05.96 -					- Engine code: K432-33
T 124 L/420 T124LA4X2LB420, T124LA4X2NB420, T124LA4X2LA420, T124LA4X2NA420	05.96 -					
T 124 L/470 T124LA4X2NA470, T124LA4X2NB470, T124LA4X2LB470, T124LA4X2LA470	01.00 -					
T 144 L/460 T144LA4X2NA460, T144LA4X2LB460, T144LA4X2NB460, T144LA4X2LA460	03.97 -					
T 144 L/530 T144LA4X2LB530, T144LA4X2LA530, T144LA4X2NB530, T144LA4X2NA530	03.97 -					

Vehicle list

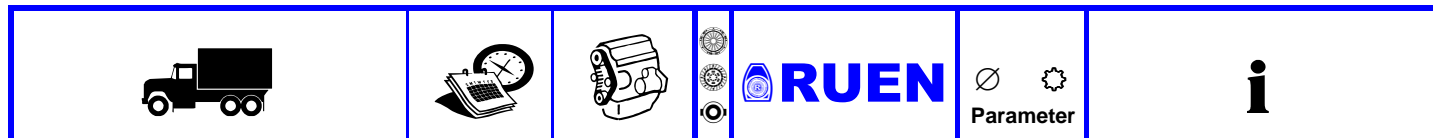

SCANIA

P, G, R, T - series

01.03 -

P 230	04.04 -	DC 11.08		4300.90.112	430 24	- Engine code: K432-20
P 230 P230DB4X2MNA, Utility truck, 4x2	07.09 -	DC 11.09		4394.20.00	MFZ430	
P 230, R 230 G230DB4X2MNA, G230LB4x2HNA	09.04 -	DC 16.03		4392.30.00	430WGTZ	
P 230, R 230	09.04 -	DC 16.08		8934.40.00	KZISZ - 5	
P 230, R 230	09.04 -	DC 16.17		4300.90.222	430 24	- Engine code: K432-26
P 270	09.04 -	DC 9.01		4394.20.00	MFZ430	
P 310, R 310	09.04 -	DC 9.04		4392.30.00	430WGTZ	
P 340 P340CB4X2HHZ	09.04 -	DC 9.11		8934.40.00	KZISZ - 5	
P 380 P380LA4X2MNA, P380LA4X2MNB, P380LA4X2MLA	09.04 -	DC 9.12		4300.90.212	430 24	- Engine code: K432-27
R 340 R340LA4X2MHA, R340LA4X2MHZ, R340LA4X2MNA, R340LA4X2MLA, R340LA4X2MNB, R340LA4X2MLB	03.04 -	DC 9.13		4394.20.00	MFZ430	- Engine code: K432-44
R 380 R380LA4X2MNA, R380LA4X2MHA, R380LA4X2MLB, R380LA4X2MHZ, R380LA4X2MLA, R380LA4X2MNB, R380LA4X2MLB	03.04 -	DC 9.16		4392.30.00	430WGTZ	
R 380 R380LA4X2MNA, R380LA4X2MHA, R380LA4X2MLB, R380LA4X2MHZ, R380LA4X2MLA, R380LA4X2MNB, R380LA4X2MLB	03.04 -	DC 9.18		8934.40.00	KZISZ - 5	
R 380 R380LA4X2MNA, R380LA4X2MHA, R380LA4X2MLB, R380LA4X2MHZ, R380LA4X2MLA, R380LA4X2MNB, R380LA4X2MLB	03.04 -	DC 9.30		4300.90.113	430 24	- Engine code: K432-33
R 380 R380LA4X2MNA, R380LA4X2MHA, R380LA4X2MLB, R380LA4X2MHZ, R380LA4X2MLA, R380LA4X2MNB, R380LA4X2MLB	03.04 -	DC 9.35		4393.20.00	MFZ430	- Engine code: K432-35
R 380 R380LA4X2MNA, R380LA4X2MHA, R380LA4X2MLB, R380LA4X2MHZ, R380LA4X2MLA, R380LA4X2MNB, R380LA4X2MLB	03.04 -	DC 9.39		4393.30.00	430WGTZ	- Engine code: K432-39
R 380 R380LA4X2MNA, R380LA4X2MHA, R380LA4X2MLB, R380LA4X2MHZ, R380LA4X2MLA, R380LA4X2MNB, R380LA4X2MLB	03.04 -	DT 12.06		8934.40.00	KZISZ - 5	
R 580 R580LB4X2MLA, R580LB4X2MNB, R580LB4X2MLB, R580LB4X2MNA	03.04 -			4300.90.111	430 24	- Engine code: K432-36
R 620 R620LB4X2MNB, R620LB4X2MLB, R620LB4X2MNA, R620LB4X2MLA	03.04 -			4393.20.00	MFZ430	- Engine code: K432-37
R 620, 6x2	09.05 -			4392.30.00	430WGTZ	
T 470	09.04 - 10.05			8934.40.00	KZISZ - 5	
				4300.90.213	430 24	- Engine code: 432-38
				4393.20.00	MFZ430	
				4392.30.00	430WGTZ	
				8934.40.00	KZISZ - 5	
				4300.90.232	430 24	- Engine code: K432-48
				4394.20.00	MFZ430	
				4392.30.00	430WGTZ	
				8934.40.00	KZISZ - 5	
				4300.90.214	430 24	- Engine code: K432-56
				4394.20.00	MFZ430	
				4394.30.00	430WGTZ	
				8934.40.00	KZISZ - 5	

Vehicle list



SCANIA

























































P, G, R, T - series 01.03 -

P, G, R, T - Serie		01.03 -			
P, G, R, T - Serie			4300.90.112 4394.20.00 4392.30.00 8934.40.00	430 24 MFZ430 430WGTZ KZISZ - 5	- Engine code: K432-20
			4300.90.222 ⊕ 4394.20.00 4392.30.00 8934.40.00	430 24 MFZ430 430WGTZ KZISZ - 5	- Engine code: K432-26
			4300.90.212 4394.20.00 4392.30.00 8934.40.00	430 24 MFZ430 430WGTZ KZISZ - 5	- Engine code: K432-27 - Engine code: K432-44
			4300.90.113 4393.20.00 4393.30.00 8934.40.00	430 24 MFZ430 430WGTZ KZISZ - 5	- Engine code: K432-33 - Engine code: K432-35 - Engine code: K432-39
			4300.90.111 4393.20.00 4392.30.00 8934.40.00	430 24 MFZ430 430WGTZ KZISZ - 5	- Engine code: K432-36 - Engine code: K432-37
			4300.90.213 4393.20.00 4392.30.00 8934.40.00	430 24 MFZ430 430WGTZ KZISZ - 5	- Engine code: K432-38
			4300.90.232 4394.20.00 4392.30.00 8934.40.00	430 24 MFZ430 430WGTZ KZISZ - 5	- Engine code: K432-48
			4392.30.00	430 24 430WGTZ	- Engine code: K432-25 - Engine code: K432-41 - Engine code: K432-45
			4393.20.00	430 MFZ430	- Engine code: K432-54
			P, G, R, T - Serie		
4300.90.112 4394.20.00 4392.30.00 8934.40.00	430 24 MFZ430 430WGTZ KZISZ - 5	- Engine code: K432-62			
4393.20.00	430 MFZ430	- Engine code: K432-55			
8934.40.00	KZISZ - 5	- Engine code: K432-55			
8948.40.00	KZIZ-5	- Engine code: K432-62			

Vehicle list

					
---	---	---	--	---	---

SCANIA

P, G, R, T - series		01.03 -			
G 230 G230DB6X2*4MLA, G230DB6X2*4MNA, G230DB6X2*4MLB, G230DB6X2*4MNB	09.07 -	DC 09.110 DC 12.10	 4300.90.112  4394.20.00  4392.30.00  8934.40.00	430 24 MFZ430 430WGTZ KZISZ - 5	- Engine code: K432-20 - Engine code: K432-62
G 230, P 230 P230DB4X2MLA, P230DB4X2MNA, G230DB4X2MNB, P230DB4X2HLB, G230DB4X2MLB, P230DB4X2HNA, G230DB4X2MNA, G230DB4X2MLA	08.06 -	DC 12.26 DC 9.11 DC 9.12 DC 9.13 DC 9.16 DC 9.17	 4300.90.222   4394.20.00  4392.30.00  8934.40.00	430 24 MFZ430 430WGTZ KZISZ - 5	- Engine code: K432-26
G 230, P 230 G230DB4X2MNB, G230DB4X2MNZ, G230DB4x2HNZ, G230DB4X2MNA, G230DB4x2HNA, G230LB4x2HNA	09.07 -	DC 9.17 DC 9.18 DC 9.30	 4300.90.212  4394.20.00  4392.30.00  8934.40.00	430 24 MFZ430 430WGTZ KZISZ - 5	- Engine code: K432-27 - Engine code: K432-44
G 230, P 230 G230 DB6X2*4MLB, 6x2	09.07 -	DC 9.35	 4394.20.00  4392.30.00  8934.40.00	430 24 MFZ430 430WGTZ KZISZ - 5	- Engine code: K432-27 - Engine code: K432-44
G 230, P 230 G230 DB6X2*4MLB, 6x2/4	09.07 -	DC 9.39	 4300.90.113  4393.20.00  4393.30.00  8934.40.00	430 24 MFZ430 430WGTZ KZISZ - 5	- Engine code: K432-33 - Engine code: K432-35 - Engine code: K432-39
G 230, P 230, Platform/Chassis, 6x4	09.07 -		 4393.20.00  4393.30.00  8934.40.00	430 24 MFZ430 430WGTZ KZISZ - 5	- Engine code: K432-33 - Engine code: K432-35 - Engine code: K432-39
G 230, P 230, Truck Tractor, 4x2	09.07 -		 4393.20.00  4393.30.00  8934.40.00	430 24 MFZ430 430WGTZ KZISZ - 5	- Engine code: K432-33 - Engine code: K432-35 - Engine code: K432-39
G 230, P 230, Truck Tractor, 6x2	09.07 -		 4393.20.00  4393.30.00  8934.40.00	430 24 MFZ430 430WGTZ KZISZ - 5	- Engine code: K432-33 - Engine code: K432-35 - Engine code: K432-39
G 230, P 230, Truck Tractor, 6x2/4	09.07 -		 4393.20.00  4393.30.00  8934.40.00	430 24 MFZ430 430WGTZ KZISZ - 5	- Engine code: K432-33 - Engine code: K432-35 - Engine code: K432-39
G 230, P 230, Truck Tractor, 6x4	09.07 -		 4393.20.00  4392.30.00  8934.40.00	430 24 MFZ430 430WGTZ KZISZ - 5	- Engine code: K432-36 - Engine code: K432-37
G 230, P 230 P230DB4X2MLA, P230DB4X2MNA, G230DB4X2MNB, P230DB4X2HLB, G230DB4X2MLB, P230DB4X2HNA, G230DB4X2MNA, G230DB4X2MLA	07.09 -		 4393.20.00  4392.30.00  8934.40.00	430 24 MFZ430 430WGTZ KZISZ - 5	- Engine code: K432-36 - Engine code: K432-37
G 270, P 270 P270DB6X2*4MNB, G270DB6X2*4MLB, G270DB6X2*4MNB, G270DB6X2*4MLA, G270DB6X2*4MNA, P270DB6X2*4MLA, P270DB6X2*4MLB	04.04 -		 4393.20.00  4392.30.00  8934.40.00	430 24 MFZ430 430WGTZ KZISZ - 5	- Engine code: K432-38
G 270, P 270, R 270 G270DB4X2MLB, P270DB4X2MLB, G270DB4X2MNA, G270DB4X2MNB, P270DB4X2HLA, P270DB4X2MNB, P270DB4X2HNA	09.04 -		 4300.90.232  4394.20.00  4392.30.00  8934.40.00	430 24 MFZ430 430WGTZ KZISZ - 5	- Engine code: K432-48
G 310, P 310 G310DB4X2MNB, P310DB4X2MLB, P310DB4X2MNB, G310DB4X2MLB, P310DB4X2HLB, P310DB4X2HLA, P310DB4X2HNA, P310DB4X2MLA	09.04 -		 4300.90.214  4394.20.00  4394.30.00  8934.40.00	430 24 MFZ430 430WGTZ KZISZ - 5	- Engine code: K432-56
G 310, P 310 G310DB6X2*4MNA, P310DB6X2*4MLA, P310DB6X2*4MNA, G310DB6X2*4MLA, G310DB6X2*4MLB, G310DB6X2*4MNB, P310DB6X2*4MLB	09.04 -		 4392.30.00	430 24 430WGTZ	- Engine code: K432-25 - Engine code: K432-41 - Engine code: K432-45 - Engine code: K432-62
G 310, P 310 G310DB4X2MNB, P310DB4X2MLB, P310DB4X2MNB, G310DB4X2MLB, P310DB4X2HLB, P310DB4X2HLA, P310DB4X2HNA, P310DB4X2MLA	07.09 -		 4393.20.00	430 MFZ430	- Engine code: K432-54 - Engine code: K432-55 - Engine code: K432-33 - Engine code: K432-35 - Engine code: K432-36 - Engine code: K432-37 - Engine code: K432-38 - Engine code: K432-39
G 340, P 340 P340CB6X4MHZ	04.04 -		 4394.20.00	430 MFZ430	- Engine code: K432-48 - Engine code: K432-56 - Engine code: K432-62
G 340, P 340 G340CB8X4HHZ, P340CB8X4HHZ	04.04 -		 8948.40.00	KZIZ-5	- Engine code: K432-40 - Engine code: K432-41 - Engine code: K432-42 - Engine code: K432-49 - Engine code: K432-62
G 340, P 340 G340CB6X4HHZ, P340CB6X4HHZ, P340CB6X4MNZ, G340CB6X4MHZ, G340CB6X4MNZ, P340LB6X4HHZ	08.04 -		 4394.20.00	430 MFZ430	- Engine code: K432-48 - Engine code: K432-56 - Engine code: K432-62
G 340, P 340, R 340 R340CB8X4MHZ, G340CB8X4MHZ, P340CB8X4MHZ, Concrete Mixer	04.04 -		 8948.40.00	KZIZ-5	- Engine code: K432-40 - Engine code: K432-41 - Engine code: K432-42 - Engine code: K432-49 - Engine code: K432-62
G 340, P 340, R 340 R340CB8X4MHZ, G340CB8X4MHZ, P340CB8X4MHZ, Dump Truck	04.04 -		 8948.40.00	KZIZ-5	- Engine code: K432-40 - Engine code: K432-41 - Engine code: K432-42 - Engine code: K432-49 - Engine code: K432-62
G 340, P 340, R 340 R340LB4X2MNA, R340LB4X2MLA, P340CB4X2HHZ, R340LB4X2MNB, G340CB4X2HHZ, R340LB4X2MLB	04.04 -		 8948.40.00	KZIZ-5	- Engine code: K432-40 - Engine code: K432-41 - Engine code: K432-42 - Engine code: K432-49 - Engine code: K432-62

Vehicle list

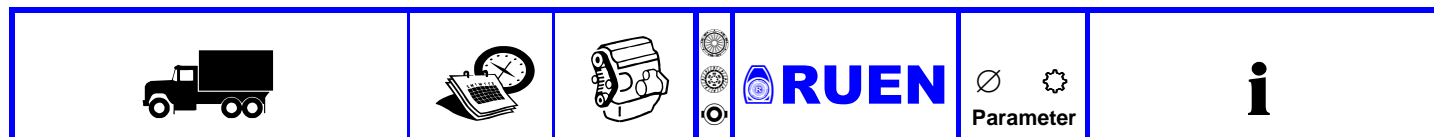

SCANIA

P, G, R, T - series 01.03 -

G 340, P 340, R 340 P340CB6X2HNA, P340LB6X2HHZ, G340CB6X2HNA	04.04 -	DC 12.10		4300.90.112	430 24	- Engine code: K432-20
		DC 12.13		4394.20.00	MFZ430	- Engine code: K432-62
G 340, R 340 R340 LA4X2MHA, R340LA4X2MNZ, R340LA4X2MHZ, R340LA4X2MNA, R340LA4X2MLA, R340LA4X2MLB	08.06 -	DC 12.17		4392.30.00	430WGTZ	
		DC 12.18		8934.40.00	KZISZ - 5	
		DC 12.24		4300.90.222	430 24	- Engine code: K432-26
G 360, P 360 P360LA6x2/2MNA	04.10 -	DC 13.05		4394.20.00	MFZ430	
G 360, P 360, R 360 R360LB4X2MLB, R360LB4X2MNB, R360LB4X2MLA, R360LB4X2MNA	04.10 -	DC 13.06		4392.30.00	430WGTZ	
		DC 13.103		8934.40.00	KZISZ - 5	
		DC 13.113		4300.90.212	430 24	- Engine code: K432-27
G 360, P 360, R 360 G360LA4X2MLA, P360LA4X2MLA, P360LA4X2MNA, P360LA4X2MLB, R360LA4X2MEB, P360LA4X2MNB	04.10 -	DC 13.114		4394.20.00	MFZ430	- Engine code: K432-44
		DC 13.115		4392.30.00	430WGTZ	
		DC 13.120		8934.40.00	KZISZ - 5	
G 380, P 380 P380CB6X4MHZ	04.04 -			4300.90.113	430 24	- Engine code: K432-33
G 380, P 380 G380CB4X2HHZ, P380CB4X2HHZ	04.04 -			4393.20.00	MFZ430	- Engine code: K432-35
				4393.30.00	430WGTZ	- Engine code: K432-39
G 380, P 380, R 380 G380CB6X4MNZ, P380CB6X4HHZ, P380CB6X4MNZ, P380LB6X4HHZ, G380CB6X4HHZ, G380CB6X4MHZ	08.04 -			8934.40.00	KZISZ - 5	
G 380, P 380, R 380 G380CB8X4MHZ, P380CB8X4MHZ, R380CB8X4MHZ, Concrete Mixer	04.04 -			4300.90.111	430 24	- Engine code: K432-36
				4393.20.00	MFZ430	- Engine code: K432-37
				4392.30.00	430WGTZ	
				8934.40.00	KZISZ - 5	
G 380, P 380, R 380 G380CB8X4MHZ, P380CB8X4MHZ, R380CB8X4MHZ, Dump Truck	04.04 -			4300.90.213	430 24	- Engine code: K432-38
				4393.20.00	MFZ430	
				4392.30.00	430WGTZ	
				8934.40.00	KZISZ - 5	
G 380, P 380, R 380 R380LA4X2MNA, G380LA4X2MLA, R380LA4X2MLB, P380LA4X2MNA, P380LA4X2MNB, R380LA4X2MLA, P380LA4X2MHZ	03.08 -			4300.90.232	430 24	- Engine code: K432-48
				4394.20.00	MFZ430	
				4392.30.00	430WGTZ	
				8934.40.00	KZISZ - 5	
G 380, P 380, R 380 P380CB6X2HNA, P380LB6X2HHZ, G380CB6X2HNA	04.04 -			4300.90.214	430 24	- Engine code: K432-56
G 380, P 380, R 380 R380LA4X2MNA, R380LA4X2MHA, R380LA4X2MHZ, R380LA4X2MNZ	04.04 -			4394.20.00	MFZ430	
				4394.30.00	430WGTZ	
				8934.40.00	KZISZ - 5	
G 380, P 380, R 380 P380CB8X4HHZ, G380CB8X4HHZ, P380LB8X4	09.05 -			4392.30.00	430 24	- Engine code: K432-25
					430WGTZ	- Engine code: K432-41
						- Engine code: K432-45
						- Engine code: K432-62
G 400, P 400, R 400 P400LA4X2MNA, P400LA4X2MLB, R400LA4X2MEB, G400LA4X2MLA, P400LA4X2MLA, P400LA4X2MNB	03.08 -					
G 400, P 400, R 400 P400CB8X4MHZ, G400CB8x4MHZ, R400CB8x4MHZ	07.09 -			4393.20.00	430	- Engine code: K432-54
G 400, P 400, R 400 R400LB6X2*4MNB, P400LB6X2*4HSA, R400LB6X2*4MNA, R400LB6X2*4MLB, R400LB6X2*4MLA	04.10 -				MFZ430	- Engine code: K432-55
						- Engine code: K432-33
						- Engine code: K432-35
						- Engine code: K432-36
						- Engine code: K432-37
						- Engine code: K432-38
						- Engine code: K432-39
G 400, P 400, R 400 R400LA4X2MLB, R400LA4X2MNA, R400LA4X2MLA, R400LA4X2MNB	04.10 -					
G 400, R 400 R400LB4X2MLA, R400LB4X2MLB, R400LB4X2MNA, R400LB4X2MNB	03.08 -			4394.20.00	430	- Engine code: K432-48
					MFZ430	- Engine code: K432-56
						- Engine code: K432-62
G 400, R 400 G400LA6X2/2MNA, R400LA6X2/2MNA	03.09 -			8948.40.00	KZIZ-5	- Engine code: K432-40
G 400, R 400 R400LB6X2*4MNA, G400LB6x2*4MNA	01.10 -					- Engine code: K432-41
G 400, R 400 R400CA6x4MHZ, G400CA6x4MHZ	01.10 -					- Engine code: K432-42
G 400, R 400 R400LA6x4HNA, G400LA6x4HNA, R400LA6x4HSZ, G400LA6x4HSZ	08.10 -					- Engine code: K432-49
G 400, R 400 G400LA6x2/4MNA	08.10 -					- Engine code: K432-62
G 410, P 410, R 410 G410CB8x4MHZ, P410CB8x4MHZ, R410CB8x4MHZ	09.13 -					

Vehicle list

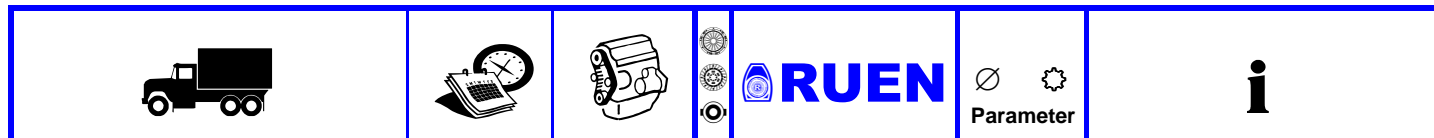

SCANIA

P, G, R, T - series

01.03 -

G 410, P 410, R 410 G410LA6x2/2MNA, R410LA6x2/2MNA, P410LA6x2/2MNA	09.13 -	DC 12.06		4300.90.112	430 24	- Engine code: K432-20
G 410, P 410, R 410 R410LA6x2/4MNA, R490LB6x2*4MNA, G410LA6x2/4MNA, P410LA6x2/4MNA, G490LB6x2*4MNA	09.13 -	DC 12.14		4394.20.00	MFZ430	- Engine code: K432-62
G 410, P 410, R410 R410LA4x2MNA, G410LA4x2MNA, P410LA4x2MNA	09.13 -	DC 12.15		4392.30.00	430WGTZ	
G 410, R 410 P410LB6x2*4MNA, G410LB6x2*4MNA	09.13 -	DC 12.22		8934.40.00	KZISZ - 5	
G 410, R 410 G410LA6x4HSZ, R410LA6x4HSZ, R410CA6x4MHZ, R410LA6x4HSA, G410CA6x4MHZ, G410LA6x4HSA	09.13 -	DC 13.10		4300.90.222	430 24	- Engine code: K432-26
G 420 G420LA6X4MHZ	03.04 -	DC 13.109		4394.20.00	MFZ430	
G 420, P 420, R 420	09.04 -	DC 13.112		4392.30.00	430WGTZ	
G 420, P 420, R 420 G420LA4X2MLA, R420LA4X2MEB	03.04 -	DC 13.115		8934.40.00	KZISZ - 5	
G 420, P 420, R 420 R420CB8X4HHZ, G420CB8X4MHZ, P420CB8X4HHZ, R420CB8X4MHZ	09.05 -	DC 13.121		4300.90.212	430 24	- Engine code: K432-27
G 420, R 420	01.08 -	DC 13.124		4394.20.00	MFZ430	- Engine code: K432-44
G 420, R 420 R420LB6X2*4MNA, G420LB6X2*4MNA	01.08 -	DC 13.147		4392.30.00	430WGTZ	
G 420, R 420 G420CA6X4MHZ, R420CA6X4MHZ	01.08 -	DT 12.06		8934.40.00	KZISZ - 5	
G 440, R 440, 4x2	01.08 -	DT 12.11		4300.90.113	430 24	- Engine code: K432-33
G 440, R 440, 6x2	01.08 -	DT 12.12		4393.20.00	MFZ430	- Engine code: K432-35
G 440, R 440, 6x4	01.08 -	DT 12.18		4393.30.00	430WGTZ	- Engine code: K432-39
G 440, R 440 G440LA4X2MLA, R440LA4X2MEB	03.08 -			8934.40.00	KZISZ - 5	
G 440, R 440 R440CB8x4MHZ, G440CB8x4MHZ	07.09 -			4300.90.111	430 24	- Engine code: K432-36
G 440, R 440 R440LB6X2*4MNB, R440LB6X2*4MLB, R440LB6X2*4MNA, R440LB6X2*4MLA	01.10 -			4393.20.00	MFZ430	- Engine code: K432-37
G 440, R 440 G440LB6x2*4MNA, R440LB6x2*4MNA	01.10 -			4392.30.00	430WGTZ	
G 440, R 440 R440CA6x4MHZ, G440CA6x4MHZ	01.10 -			8934.40.00	KZISZ - 5	
G 440, R 440 R440LA4X2MLB, G440LA4X2MLA, R440LA4X2MLA, R440LA4X2MNA, R440LA4X2MNB	04.10 -			4300.90.232	430 24	- Engine code: K432-48
G 440, R 440 G440LA6x4HNA	08.10 -			4394.20.00	MFZ430	
G 440, R 440 R440LA6x2/2MNA, G440LA6x2/2MNA	08.10 -			4392.30.00	430WGTZ	- Engine code: K432-25
G 440, R 440 R400LA6X2/4MNA, G400LA6x2/4MNA	08.10 -					- Engine code: K432-41
G 450, P 450, R 450 R450CB8x4MHZ, P450CB8x4MHZ, G450CB8x4MHZ	09.13 -					- Engine code: K432-45
G 450, P 450, R 450 P450LA4x2MNA, R450LA4x2MNA, G450LA4x2MNA	09.13 -			4393.20.00	430	- Engine code: K432-54
G 450, P 450, R 450 P450LA6x2/2MNA, G450LA6x2/2MNA, R450LA6x2/2MNA	09.13 -				MFZ430	- Engine code: K432-55
G 450, P 450, R 450 P450LA6x2/4MNA, G450LA6x2/4MNA, R450LA6x2/4MNA	09.13 -			4394.20.00	430	- Engine code: K432-56
G 450, R 450 G450LA6x4HSA, G450CA6x4MHZ, R450CA6x4MHZ, R450LA6x4HSZ, R450LA6x4HSA, G450LA6x4HSZ	01.12 -				MFZ430	- Engine code: K432-62
G 450, R 450 R450LB6x2*4MNA, G450LB6x2*4MNA	09.13 -			8948.40.00	KZIZ-5	- Engine code: K432-40
G 470, 6x4	01.10 -					- Engine code: K432-41
G 470, 8x4	01.10 -					- Engine code: K432-42
G 470, P 470, R 470	09.05 -					- Engine code: K432-49
						- Engine code: K432-62

Vehicle list



SCANIA

P, G, R, T - series 01.03 -

G 470, R 470 R470LA4X2MNA, R470LB4X2MLA, R470LA4X2MNB, R470LB4X2MNA, R470LB4X2MLB, R470LB4X2MNB, R470LA4X2MLA, R470LA4X2MLB	03.04 -	DC 13.07 DC 13.110 DC 13.111 DC 13.125	4300.90.112 4394.20.00 4392.30.00 8934.40.00	430 24 MFZ430 430WGTZ KZISZ - 5	- Engine code: K432-20 - Engine code: K432-62
G 480 G480CB10x4*6EHZ	01.12 -	DC 9.13	4300.90.222	430 24 MFZ430 430WGTZ KZISZ - 5	- Engine code: K432-26
G 480, R 480 G480CB8X4MHZ, R480CB8X4MHZ, 11716cc	04.04 -	DC 9.16 DC 9.30	4394.20.00 4392.30.00 8934.40.00	430 24 MFZ430 430WGTZ KZISZ - 5	
G 480, R 480 G480CB8X4MHZ, R480CB8X4MHZ, 12742cc	04.04 -	DC 9.35 DC 9.39	4300.90.212	430 24 MFZ430 430WGTZ KZISZ - 5	- Engine code: K432-27 - Engine code: K432-44
G 480, R 480 R480CA6X4MHZ, G480CA6X4MHZ	07.04 -	DT 12.03 DT 12.06	4394.20.00 4392.30.00 8934.40.00	430 24 MFZ430 430WGTZ KZISZ - 5	
G 480, R 480 G480LA6x2/4MNA	08.06 -	DT 12.17	4300.90.113	430 24 MFZ430 430WGTZ KZISZ - 5	- Engine code: K432-33 - Engine code: K432-35 - Engine code: K432-39
G 480, R 480 G480LB6X2*4MNA, R480LB6X2*4MNA	01.08 -		4393.20.00 4393.30.00 8934.40.00	430 24 MFZ430 430WGTZ KZISZ - 5	
G 480, R 480 G480LA6x4HNA, R480LA6x4HNA, G480LA6x4HSZ, R480LA6x4HSZ	01.08 -		4300.90.111	430 24 MFZ430 430WGTZ KZISZ - 5	- Engine code: K432-36 - Engine code: K432-37
G 480, R 480 R480CA6X4MHZ, G480CA6X4MHZ	01.08 -		4393.20.00 4392.30.00 8934.40.00	430 24 MFZ430 430WGTZ KZISZ - 5	
G 480, R 480 R480LA4X2MEB, 11716cc	03.08 -		4300.90.213	430 24 MFZ430 430WGTZ KZISZ - 5	- Engine code: K432-38
G 480, R 480 R480LA4X2MEB, 12742cc	03.08 -		4393.20.00 4392.30.00 8934.40.00	430 24 MFZ430 430WGTZ KZISZ - 5	
G 480, R 480 G480LB6X2*4MNA, R480LB6X2*4MNA	01.10 -		4300.90.232	430 24 MFZ430 430WGTZ KZISZ - 5	- Engine code: K432-48
G 480, R 480 G480LA6x4HNA, R480LA6x4HNA, G480LA6x4HSZ, R480LA6x4HSZ	08.10 -		4394.20.00 4392.30.00 8934.40.00	430 24 MFZ430 430WGTZ KZISZ - 5	
G 480, R 480 G480LA6x2/2MNA, R480LA6x2/2MNA	08.10 -		4300.90.214	430 24 MFZ430 430WGTZ KZISZ - 5	- Engine code: K432-56
G 480, R 480, P 480 R480LA4X2MLA, R480LA4X2MLB, R480LA4X2MNA, R480LA4X2MNB	04.10 -		4394.20.00 4394.30.00 8934.40.00	430 24 MFZ430 430WGTZ KZISZ - 5	
G 490, R 490 R490CB8x4MHZ, G490CB8x4MHZ	09.13 -		4392.30.00	430 24 430WGTZ	- Engine code: K432-25 - Engine code: K432-41 - Engine code: K432-45 - Engine code: K432-62
G 490, R 490 P490LB6x2*4MNA, G490LB6x2*4MNA	09.13 -		4393.20.00	430 MFZ430	- Engine code: K432-54 - Engine code: K432-55 - Engine code: K432-33 - Engine code: K432-35 - Engine code: K432-36 - Engine code: K432-37 - Engine code: K432-38 - Engine code: K432-39
G 490, R 490 R490LA4x2MNA, G490LA4x2MNA	09.13 -		4394.20.00	430 MFZ430	- Engine code: K432-48 - Engine code: K432-56 - Engine code: K432-62
G 490, R 490 R490LA6x2/2MNA, G490LA6x2/2MNA	09.13 -		8948.40.00	KZIZ-5	- Engine code: K432-40 - Engine code: K432-41 - Engine code: K432-42 - Engine code: K432-49 - Engine code: K432-62
G 490, R 490 R490LB6x2*4MNA, G490LA6x2/4MNA, G490LB6x2*4MNA, R490LA6x2/4MNA	09.13 -				
G 490, R 490 G490CA6x4MHZ, R490CA6x4MHZ, R490LA6x4HSZ, G490LA6x4HSZ, G490LA6x4HSA, R490LA6x4HSA	09.13 -				
P 230 P230DA4X2MNZ	09.04 -				
P 230 P230DB6X2*4MNA	04.06 -				
P 230 P230DB4X2HNA	09.07 -				
P 230 P230DB6X2*4MLA, P230DB6X2*4MLB, P230DB6X2*4MNB, P230DB6X2*4MNA	09.07 -				
P 230	09.07 -				
P 230 P230DB6X2*4MNA	09.07 -				
P 230 P230DB4X2HNA, P230DB4X2HNZ	01.08 -				
P 230 P230DB4X2HNA, P230DB4X2HNZ, Dump Truck, 4x2	07.09 -				
P 230 P230DB6X2*4MNA	07.09 -				
P 230 P230DB6X2*4MNB	09.09 -				

Vehicle list



SCANIA

P, G, R, T - series		01.03 -			
P 230 P230DB6X2MNA	08.12 -	DC 09.109	4300.90.112	430 24	- Engine code: K432-20
P 230, R 230, 6x2	09.05 -	DC 09.110	4394.20.00	MFZ430	- Engine code: K432-62
P 230, R 230, 6x2/4	09.05 -	DC 09.111	4392.30.00	430WGTZ	
P 230, R 230 P230DB6X2MNA	08.06 -	DC 09.113	8934.40.00	KZISZ - 5	
P 250 P250DB4x2MNA	01.10 -	DC 09.E02	4300.90.222 ⊕	430 24	- Engine code: K432-26
P 250 P250CB6x4MHZ	01.12 -	DC 9.02	4394.20.00	MFZ430	
P 250, 8x2	01.12 -	DC 9.03	4392.30.00	430WGTZ	
P 250, 8x4	01.12 -	DC 9.05	8934.40.00	KZISZ - 5	
P 250 P250DB6x2MNA	08.12 -	DC 9.06	4300.90.212	430 24	- Engine code: K432-27
P 250 P250DB4x2HNZ	09.13 -	DC 9.11	4394.20.00	MFZ430	- Engine code: K432-44
P 250 P250DB6x2*4MNA	09.13 -	DC 9.12	4392.30.00	430WGTZ	
P 260, 11020cc	04.04 -	DC 9.13	8934.40.00	KZISZ - 5	
P 260, 9000cc	04.04 -	DC 9.16	4300.90.113	430 24	- Engine code: K432-33
P 270 P270DB4X2HNA,	04.04 -	DC 9.17	4393.20.00	MFZ430	- Engine code: K432-35
P270DB4X2HNZ	04.04 -	DC 9.18	4393.30.00	430WGTZ	- Engine code: K432-39
P 270 P270DB4X2HNA	04.04 -	DC 9.29	8934.40.00	KZISZ - 5	
P 270 P270DB6X2*4MNA	04.04 -	DC 9.36	4300.90.111	430 24	- Engine code: K432-36
P 270 P270LB8X4	04.04 -	DC 9.38	4393.20.00	MFZ430	- Engine code: K432-37
P 270	04.06 -	DC 9.39	4392.30.00	430WGTZ	
P 270 P270CB6X4MHZ	08.06 -	OC 9.G05	8934.40.00	KZISZ - 5	
P 270	01.12 -	OSC 11.03	4300.90.213	430 24	- Engine code: K432-38
P 270, R 270, 6x2	04.04 -		4393.20.00	MFZ430	
P 270, R 270, 6x2/4	04.04 -		4392.30.00	430WGTZ	
P 270, R 270 P270DA4X2MNZ	09.04 -		8934.40.00	KZISZ - 5	
P 270, R 270 P270DB6X2MNA	08.06 -		4300.90.232	430 24	- Engine code: K432-48
P 280	04.04 -		4394.20.00	MFZ430	
P 280 P280DB4x2HNZ	07.09 -		4392.30.00	430WGTZ	
P 280 P280CB6x4MHZ	07.09 -		8934.40.00	KZISZ - 5	
P 280 P280DB4x2MNA, Utility truck	07.09 -		4300.90.214	430 24	- Engine code: K432-56
P 280 P280DB4x2MNA, Platform/Chassis	07.09 -		4394.20.00	MFZ430	
P 280 P280DB6x2*4MNA	07.09 -		4394.30.00	430WGTZ	
P 280 P280DB6x2*4MNb	09.09 -		8934.40.00	KZISZ - 5	
P 280 P280LB6x4MNB	09.09 -		4392.30.00	430 24	- Engine code: K432-25
P 280 P280DB6x2MNA	08.12 -			430WGTZ	- Engine code: K432-41
P 280 P280DB6x2*4MNA	09.13 -				- Engine code: K432-45
P 280 P280CB6x4MHZ	09.13 -				- Engine code: K432-62
P 300	04.04 -		4393.20.00	430	- Engine code: K432-54
P 310, Dump Truck	01.11 -			MFZ430	- Engine code: K432-55
P 310, Platform/Chassis	01.11 -				- Engine code: K432-33
P 310, 8x2	01.03 -				- Engine code: K432-35
P 310, 8x4/4	01.03 -				- Engine code: K432-36
P 310 P310LB8X4	04.04 -				- Engine code: K432-37
P 310 P310LA6X4	04.04 -				- Engine code: K432-38
P 310 P310DB6X2*4MNA, 8867cc	09.04 -				- Engine code: K432-39
P 310 P310DB6X2*4MNA, 9300cc	09.04 -				
P 310 P310LB6X4	09.04 -				
P 310	04.06 -				
P 310 P310CB6X4MHZ	08.06 -				
P310 P310DB4X2HNZ	01.08 -				
P 310	01.10 -				
G 310, P 310	01.12 -				
P 310 P310DB6X2MNA	08.12 -				
P 310, R 310, 6x2	04.04 -				
P 310, R 310, 6x2/4	04.04 -				
			4394.20.00	430	- Engine code: K432-48
				MFZ430	- Engine code: K432-56
					- Engine code: K432-62
			8948.40.00	KZIZ-5	- Engine code: K432-40
					- Engine code: K432-41
					- Engine code: K432-42
					- Engine code: K432-49
					- Engine code: K432-62

Vehicle list



SCANIA

P, G, R, T - series 01.03 -

P 310, R 310 P310LB6X2, P310DB6X2MNA	09.04 -	DC 09.108		4300.90.112	430 24	- Engine code: K432-20
P 310, R 310 P310DA4X2MNZ, P310LA4X2	09.04 -	DC 11.08		4394.20.00	MFZ430	- Engine code: K432-62
P 320 P320DB4x2HNZ	07.09 -	DC 12.10		4392.30.00	430WGTZ	
P 320 P320CB6x4MHZ	07.09 -	DC 9.11		8934.40.00	KZISZ - 5	
P 320 P320DB4x2MNA	07.09 -	DC 9.18		4300.90.222	430 24	- Engine code: K432-26
P 320 P320DB6x2*4MNA	07.09 -	DC 9.22		4394.20.00	MFZ430	
P 320 P320DB6x2*4MNB	07.09 -	DC 9.32		4392.30.00	430WGTZ	
P 320 P320LB6x4MNB	09.09 -	DC 9.37		8934.40.00	KZISZ - 5	
P 320 P320DB6x2MNA	09.09 -	DC 9.38		4300.90.212	430 24	- Engine code: K432-27
P 320 P320DB4x2MNA	08.12 -	OC 09.102		4394.20.00	MFZ430	- Engine code: K432-44
P 320 P320DB6x2*4MNA	01.13 -			4392.30.00	430WGTZ	
P 320 P320CB6x4MHZ	09.13 -			8934.40.00	KZISZ - 5	
P 340 P340CB6X4MHZ	09.13 -			4300.90.113	430 24	- Engine code: K432-33
P 340 P340CB8X4MHZ	04.04 -			4393.20.00	MFZ430	- Engine code: K432-35
P 340 P340CB4X2HHZ	04.04 -			4393.30.00	430WGTZ	- Engine code: K432-39
P 340 P340CB4X4	04.04 -			8934.40.00	KZISZ - 5	
P 340 P340CB6X2HNA	04.04 -			4300.90.111	430 24	- Engine code: K432-36
P 340 P340LB6X2*4HHA, 10600cc	04.04 -			4393.20.00	MFZ430	- Engine code: K432-37
P 340 P340LB6X2*4HHA, 11700cc	04.04 -			4392.30.00	430WGTZ	
P 340 P340CB6X4HHZ, P340CB6X4MNZ, P340CB6X4EHZ, P340LB6X4HHZ	04.04 -			8934.40.00	KZISZ - 5	
P 340 P340LB8X2HHA, 10600cc	04.04 -			4300.90.213	430 24	- Engine code: K432-38
P 340 P340LB8X2HHA, 11700cc	04.04 -			4393.20.00	MFZ430	
P 340 P340CB8X4HHZ	04.04 -			4392.30.00	430WGTZ	
P 340 P340LB8X2*6HHA	04.04 -			8934.40.00	KZISZ - 5	
P 340 P340CA4X4HHZ, 11700cc	04.04 -			4300.90.232	430 24	- Engine code: K432-48
P 340 P340CA4X4HHZ, 10600cc	04.04 -			4394.20.00	MFZ430	
P 340 P340CA6X4HHZ	04.04 -			4392.30.00	430WGTZ	
P 340	09.04 -			8934.40.00	KZISZ - 5	
P 340 P340CB8X4MHZ	10.06 -			4300.90.214	430 24	- Engine code: K432-56
P 340 P340LB8X2*6HHA	10.06 -			4394.20.00	MFZ430	
P 340	01.08 -			4394.30.00	430WGTZ	
P 340, Dump Truck	01.11 -			8934.40.00	KZISZ - 5	
P 340, Platform/Chassis	01.11 -			4392.30.00	430 24	- Engine code: K432-25
P 340, Truck Tractor	01.11 -				430WGTZ	- Engine code: K432-41
P 340, R 340 R340CB8X4MHZ	04.04 -					- Engine code: K432-45
P 340, R 340 R340CB8X4MHZ, P340CB8X4MHZ	04.04 -					- Engine code: K432-62
G 340, P 340, R 340 R340LB4X2MNA, R340LB4X2MLA, P340CB4X2HHZ, R340LB4X2MNB, R340LB4X2MLB	04.04 -					- Engine code: K432-54
P 340, R 340 P340LB8X2*6HHA, R340LB8X2*6HHA, 11700cc	04.04 -			4393.20.00	430	- Engine code: K432-55
P 340, R 340 P340LB8X2*6HHA, R340LB8X2*6HHA, 10600cc	04.04 -				MFZ430	- Engine code: K432-33
P 340, R 340 R340LB8X4*4HHA, P340LB8X4*4HHA, 11700cc	04.04 -					- Engine code: K432-35
P 340, R 340 R340LB8X4*4HHA, P340LB8X4*4HHA, 10600cc	04.04 -					- Engine code: K432-36
P 340, R 340	04.04 -					- Engine code: K432-37
G 340, P 340, R 340 P340LA4X2MNB, P340LA4X2MNA, P340CA4X2HHZ, R340LA4X2MNA, P340LA4X2MLA, P340LA4X2MLB, R340LA4X2MLA	09.04 -					- Engine code: K432-38
P 340, R 340 R340LA6X2/4MNA, P340LA6X2/4MNA	09.04 -					- Engine code: K432-39
	08.06 -			4394.20.00	430	- Engine code: K432-48
					MFZ430	- Engine code: K432-56
				8948.40.00	KZIZ-5	- Engine code: K432-62
						- Engine code: K432-40
						- Engine code: K432-41
						- Engine code: K432-42
						- Engine code: K432-49
						- Engine code: K432-62

Vehicle list

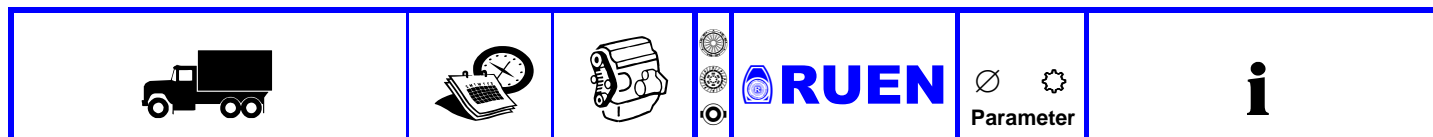

SCANIA						
P, G, R, T - series		01.03 -				
P 340, R 340 P340LA4X2MNB, P340LA4X2MHA, P340LA4X2MNA, P340CA4X2HHZ, R340LA4X2MNA, P340LA4X2MLA, P340LA4X2MLB, R340LA4X2MLA	10.06 -	DC 09.112		4300.90.112	430 24	- Engine code: K432-20
		DC 11.09		4394.20.00	MFZ430	- Engine code: K432-62
		DC 12.10		4392.30.00	430WGTZ	
		DC 12.13		8934.40.00	KZISZ - 5	
P 360 P360LB6X4HSZ	10.07 -	DC 12.17		4300.90.222	430 24	- Engine code: K432-26
		DC 12.18		4394.20.00	MFZ430	
P 360 P360DB4x2HNZ	03.08 -	DC 13.06		4392.30.00	430WGTZ	
P 360 P360CB8X4MHZ, 12742cc	07.09 -	DC 13.114		8934.40.00	KZISZ - 5	
P 360 P360CB8X4MHZ, 9300cc	07.09 -	DC 13.116				
P 360 P360LB8x2*6HSA	07.09 -			4300.90.212	430 24	- Engine code: K432-27
P 360 P360LA6X2/4MNA	09.09 -			4394.20.00	MFZ430	- Engine code: K432-44
P 360 P360LB8X2HSA	04.10 -			4392.30.00	430WGTZ	
P 360 P360LA4X2MNA	04.10 -			8934.40.00	KZISZ - 5	
P 360 P360LA6x2/2MNA	08.10 -			4300.90.113	430 24	- Engine code: K432-33
P 360 P360LA6X2/4MNA	08.10 -			4393.20.00	MFZ430	- Engine code: K432-35
P 360 P360DB6x2*4MNA	08.10 -			4393.30.00	430WGTZ	- Engine code: K432-39
P 360 P360DB4x2HNZ	09.13 -			8934.40.00	KZISZ - 5	
P 360 P360DB4x2MNA	09.13 -					
P 360 P360DB6x2MNA	09.13 -			4393.20.00	430 24	- Engine code: K432-36
P 360 P360DB6x2*4MNA	09.13 -			4392.30.00	MFZ430	- Engine code: K432-37
P 360 P360DB6x2*4MNA	09.13 -			8934.40.00	430WGTZ	
P 360 P360CB6x4MHZ	09.13 -				KZISZ - 5	
G 360, P 360, R 360 P360LB6X2HSZ, R360LB6X2MLA, R360LB6X2MNB, R360LB6X2MLB, R360LB6X2MNA	04.10 -			4300.90.213	430 24	- Engine code: K432-38
P 360, R 360 R360LB6X2*4MLA, P360LB6X2*4HSA, R360LB6X2*4MNA, R360LB6X2*4MNB, R360LB6X2*4MLB	04.10 -			4393.20.00	MFZ430	
P 360, R 360 P360LB8X2*6HSA, R360LB8X2*6HSA	04.10 -			4392.30.00	430WGTZ	- Engine code: K432-48
P 360, R 360 P360LB8X4*4HSA, R360LB8X4*4HSA	04.10 -			8934.40.00	KZISZ - 5	
P 360, R 360 R360LA4X2MLB, R360LA4X2MNA, R360LA4X2MNB, R360LA4X2MLA	04.10 -			4300.90.214	430 24	- Engine code: K432-56
P 370 P370CB8x4MHZ	09.13 -			4394.20.00	MFZ430	
P 370 P370LB6x2MNA	09.13 -			4394.30.00	430WGTZ	
P 370	09.13 -				KZISZ - 5	
P 370 P370LA4x2MNA	09.13 -					
P 370 P370LA6x2/2MNA, 23.45t	09.13 -			4392.30.00	430 24	- Engine code: K432-25
P 370 P370LA6x2/2MNA, 23.80t	09.13 -				430WGTZ	- Engine code: K432-41
P 370 P370LA6x2/4MNA	09.13 -					- Engine code: K432-45
P 380 P380CB6x4MHZ	04.04 -					- Engine code: K432-62
P 380 P380LB6X2*4HHA	04.04 -					- Engine code: K432-54
P 380 P380LB8X2HHA	04.04 -					- Engine code: K432-55
P 380 P380CB8X4HHZ	04.04 -					- Engine code: K432-33
P 380 P380CB8X4HHZ	04.04 -					- Engine code: K432-35
P 380 P380CB8X4MHZ	04.04 -					- Engine code: K432-36
P 380 P380CB8X8	04.04 -					- Engine code: K432-37
P 380 P380CA4X4HHZ, 11700cc	04.04 -					- Engine code: K432-38
P 380 P380CA4X4HHZ, 10600cc	04.04 -					- Engine code: K432-39
G 380, P 380 P380CA6X4HHZ, P380LA6X4	04.04 -			4394.20.00	430	- Engine code: K432-48
P 380 P380LA6X4MHZ, 11716cc	04.04 -				MFZ430	- Engine code: K432-56
P 380 P380LA6X4MHZ, 10600cc	04.04 -					- Engine code: K432-62
P 380 P380CB8X4MHZ	04.04 -					
P 380	04.04 -			8948.40.00	KZIZ-5	- Engine code: K432-40
P 380 P380LB8X2*6HHA	04.04 -					- Engine code: K432-41
P 380 P380CB4X4	09.05 -					- Engine code: K432-42
P 380 P380LB8X2HHA	09.05 -					- Engine code: K432-49
P 380 P380CB8X4MHZ	10.06 -					- Engine code: K432-62

Vehicle list



SCANIA

P, G, R, T - series 01.03 -

P 380 P380LB8X2*6HHA	10.06 -	DC 11.09		4300.90.112	430 24	- Engine code: K432-20
P 380, R 380 R380CB8X4MHZ	04.04 -	DC 12.13		4394.20.00	MFZ430	- Engine code: K432-62
P 380, R 380 P380CB8X4MHZ, R380CB8X4MHZ	04.04 -	DC 12.17		4392.30.00	430WGTZ	
P 380, R 380 R380LB4X2MNA	04.04 -	DC 12.18		8934.40.00	KZISZ - 5	
P 380, R 380 R380LB4X2MNB, R380LB4X2MLA, R380LB4X2MLB, R380LB4X2MNA, P380CB4X2HHZ	04.04 -	DC 13.05		4300.90.222	430 24	- Engine code: K432-26
P 380, R 380, Platform/Chassis, 6x2	04.04 -	DC 13.06		4394.20.00	MFZ430	
P 380, R 380 R380LB6X2*4MNA, P380LB6X2*4HHA	04.04 -	DC 13.113		4392.30.00	430WGTZ	
P 380, R 380 P380CB6X4HHZ, P380CB6X4MNZ, P380LB6X4HHZ, R380LB6X4MNA	04.04 -	DC 13.115		8934.40.00	KZISZ - 5	
P 380, R 380 R380LB8X2*6HHA, R380LB8X2*6HHA	04.04 -			4300.90.212	430 24	- Engine code: K432-27
P 380, R 380 P380CB6X4HHZ, P380CB6X4MNZ, P380LB6X4HHZ, R380LB6X4MNA	04.04 -			4394.20.00	MFZ430	- Engine code: K432-44
P 380, R 380 P380LB8X4*4HHA, R380LB8X4*4HHA, 11700cc	04.04 -			4392.30.00	430WGTZ	
P 380, R 380 P380LB8X4*4HHA, R380LB8X4*4HHA, 10600cc	04.04 -			8934.40.00	KZISZ - 5	
P 380, R 380, Truck Tractor, 6x2	04.04 -			4300.90.113	430 24	- Engine code: K432-33
g 380, P 380, R 380	04.04 -			4393.20.00	MFZ430	- Engine code: K432-35
P 380, R 380, Truck Tractor, 6x2/4	04.04 -			4393.30.00	430WGTZ	- Engine code: K432-39
P 380, R 380 P380LB8X4*4HHA, R380LB8X4*4HHA, 11700cc	04.04 -			8934.40.00	KZISZ - 5	
P 380, R 380 P380LB8X4*4HHA, R380LB8X4*4HHA, 10600cc	04.04 -			4300.90.111	430 24	- Engine code: K432-36
P 380, R 380, Truck Tractor, 6x2	04.04 -			4393.20.00	MFZ430	- Engine code: K432-37
g 380, P 380, R 380	04.04 -			4392.30.00	430WGTZ	
P 380, R 380, Truck Tractor, 6x2/4	04.04 -			8934.40.00	KZISZ - 5	
P 380, R 380 R380LA4X2MNA, R380LA4X2MLB, P380LA4X2MNA, P380LA4X2MNB, R380LA4X2MLA, P380LA4X2MNB, P380CA4X2HHZ	09.04 -			4300.90.213	430 24	- Engine code: K432-38
P 380, R 380 P380LA6X2/4MNA, R380LA6X2/4MNA	09.04 -			4393.20.00	MFZ430	
P 380, R 380 P380CB6X6	09.05 -			4392.30.00	430WGTZ	
P 380, R 380 P380LB8X2*6HHA, R380LB8X2*6HHA	09.05 -			8934.40.00	KZISZ - 5	
P 380, R 380 R380LA4X2MNA, R380LA4X2MLB, P380LA4X2MNA, P380LA4X2MNB, R380LA4X2MLA, P380LA4X2MNB, R380LA4X2MNB	10.06 -			4300.90.232	430 24	- Engine code: K432-48
P 380, R 380 P380LA6X2/4MNA, R380LA6X2/4MNA	10.06 -			4394.20.00	MFZ430	
P 380, R 380 P380CB6X2HNA, R380LB6X2MNA	04.04 -			4392.30.00	430WGTZ	- Engine code: K432-41
P 400 P400LB8X2*6HSA	07.09 -			8934.40.00	KZISZ - 5	- Engine code: K432-45
P 400 P400LB6X2HSZ	04.10 -			4300.90.214	430 24	- Engine code: K432-56
P 400 P400LB8X2HSA	04.10 -			4394.20.00	MFZ430	- Engine code: K432-25
P 400 P400LA6x2/2MNA	04.10 -			4394.30.00	430WGTZ	- Engine code: K432-41
P 400 P400LA6x2/2MNA, Platform/Chassis, 6x2	08.10 -			8934.40.00	KZISZ - 5	- Engine code: K432-45
P 400 P400LA6x2/2MNA, Platform/Chassis, 6x2/4	08.10 -			4300.90.214	430 24	- Engine code: K432-62
P 400, R 400 R400LB6X2MLB, R400LB6X2MNB, R400LB6X2MLA, R400LB6X2MNA, P400LB6X2HSZ	04.10 -			4393.20.00	430	- Engine code: K432-54
P 400, R 400 P400LB8X2*6HSA, R400LB8X2*6HSA	04.10 -			MFZ430		- Engine code: K432-55
P 400, R 400 R400LB8X4*4HSA, P400LB8X4*4HSA	04.10 -			4394.20.00	430	- Engine code: K432-33
G 410, P 410 P410LB6x2MNA	09.13 -			4394.20.00	MFZ430	- Engine code: K432-35
P 410 P410LB8x2*6HSA	09.13 -			4394.20.00	MFZ430	- Engine code: K432-36
P 410 P410LA6x2/2MNA	09.13 -			4394.20.00	MFZ430	- Engine code: K432-37
				4394.20.00	MFZ430	- Engine code: K432-38
				4394.20.00	MFZ430	- Engine code: K432-38
				4394.20.00	MFZ430	- Engine code: K432-39
				4394.20.00	MFZ430	- Engine code: K432-48
				4394.20.00	MFZ430	- Engine code: K432-56
				4394.20.00	MFZ430	- Engine code: K432-62
				8948.40.00	KZIZ-5	- Engine code: K432-40
				8948.40.00	KZIZ-5	- Engine code: K432-41
				8948.40.00	KZIZ-5	- Engine code: K432-42
				8948.40.00	KZIZ-5	- Engine code: K432-49
				8948.40.00	KZIZ-5	- Engine code: K432-62

Vehicle list

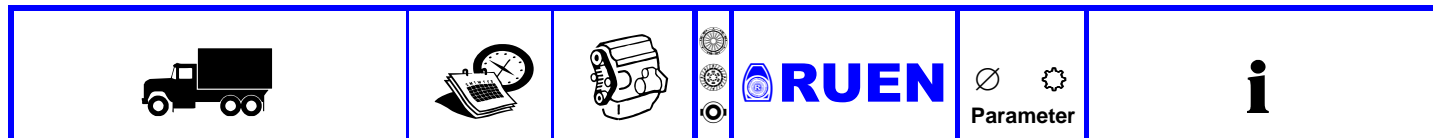

SCANIA

P, G, R, T - series		01.03 -			
P 420, G 420	01.08 -	DC 12.06	4300.90.112	430 24	- Engine code: K432-20
G 420, P 420, R 420 R420LB4X2MNA, R420LB4X2MLA, R420LB4X2MNB, R420LB4X2MLB	03.04 -	DC 12.10	4394.20.00	MFZ430	- Engine code: K432-62
		DC 12.14	4392.30.00	430WGTZ	
		DC 12.15	8934.40.00	KZISZ - 5	
P 420, R 420 R420LA4X2MNA, P420LA4X2MNA, P420LA4X2MLA, P420LA4X2MNB, R420LA4X2MLB, P420LA4X2MLA, R420LA4X2MNB	03.04 -	DC 12.22	4300.90.222	430 24	- Engine code: K432-26
		DC 12.23	4394.20.00	MFZ430	
		DC 13.06	4392.30.00	430WGTZ	
		DC 13.07	8934.40.00	KZISZ - 5	
P 420, R 420 R420LA6X2/4MNB, R420LA6X2/4MNA, R420LA6X2/4MLB, R420LA6X2/4MLA	03.04 -	DC 13.10	4300.90.212	430 24	- Engine code: K432-27
		DC 13.109	4394.20.00	MFZ430	- Engine code: K432-44
P 420, R 420 R420LA6X4, P420LA6X4, P420CA6X4HHZ	03.04 -	DC 13.110	4392.30.00	430WGTZ	
		DC 13.111	8934.40.00	KZISZ - 5	
P 420, R 420 R420LA6X2MNA	04.04 -	DC 13.112	4300.90.113	430 24	- Engine code: K432-33
P 420, R 420	09.05 -	DC 13.119	4393.20.00	MFZ430	- Engine code: K432-35
P 420	09.05 -	DC 13.124	4393.30.00	430WGTZ	- Engine code: K432-39
P 420, R 420 P420LA6X2/4MNA, R420LA6X2/4MNA	08.06 -	DC 16.03	8934.40.00	KZISZ - 5	
		DC 16.04			
P 440, R 440 R440LB8X4*4HSA, P440LB8X4*4HSA	04.10 -	DC 16.05	4300.90.111	430 24	- Engine code: K432-36
		DC 16.06	4393.20.00	MFZ430	- Engine code: K432-37
P 450 P450LB6x2MNA	09.13 -	DC 16.08	4392.30.00	430WGTZ	
P 450 P450LB8x2*6HSA	09.13 -	DC 16.09	8934.40.00	KZISZ - 5	
P 450 P450LA6x2/2MNA	09.13 -	DC 16.17	4300.90.213	430 24	- Engine code: K432-38
		DC 16.18	4393.20.00	MFZ430	
P 470, R 470 R470LA4X2MEB	03.04 -	DC 16.18	4392.30.00	430WGTZ	
P 480, R 480	04.04 -	DC 16.19	8934.40.00	KZISZ - 5	
		DC 16.22			
P 480, R 480 R480LA6X2/4MNA, R480LA6X2/4MNB, R480LA6X2/4MLA, R480LA6X2/4MLB	04.04 -	DT 12.03	4300.90.232	430 24	- Engine code: K432-48
		DT 12.06	4394.20.00	MFZ430	
P 480, R 480 R480LB8X4*4HSA, P480LB8X4*4HSA, 11716cc	04.10 -	DT 12.11	4392.30.00	430WGTZ	
P 480, R 480 R480LB8X4*4HSA, P480LB8X4*4HSA, 12742cc	04.10 -	DT 12.12	8934.40.00	KZISZ - 5	
		DT 12.14	4300.90.214	430 24	- Engine code: K432-56
P 500, R 500	03.04 -	DT 12.17	4394.20.00	MFZ430	
			4394.30.00	430WGTZ	
P 500, R 500 R500LA4X2MNA, R500LA4X2MLB, R500LA4X2HLA, R500LA4X2MNA, R500LA4X2MNB	04.04 -		8934.40.00	KZISZ - 5	
P 500, R 500 R500LA6X2MNA, P500LA6x2MNA	04.04 -		4392.30.00	430 24	- Engine code: K432-25
P 500, R 500, Dump Truck	07.09 -			430WGTZ	- Engine code: K432-41
P 500, R 500, Platform/Chassis	07.09 -				- Engine code: K432-45
P 550, Dump Truck	01.12 -				- Engine code: K432-62
P 550, Platform/Chassis	01.12 -		4393.20.00	430	- Engine code: K432-54
P 550, Truck Tractor	01.12 -			MFZ430	- Engine code: K432-55
P 560, R 560 R560LA6X2/4MNA	04.04 -				- Engine code: K432-33
P 560, R 560 R560LA4X2MNB, R560LA4X2MLA, R560LA4X2MNA, R560LA4X2MLB	11.06 -				- Engine code: K432-35
					- Engine code: K432-36
P 560, R 560 R560LA6X2MNA, P560LA6x2MNA	11.06 -		4394.20.00	430	- Engine code: K432-37
				MFZ430	- Engine code: K432-38
P 580, R 580 R580LA4X2MLA, R580LA4X2MNB, R580LA4X2HLB, R580LA4X2HNA, R580LA4X2HNB, R580LA4X2HLA, R580LA4X2MLB, R580LA4X2MNA	04.04 -		8948.40.00	KZIZ-5	- Engine code: K432-39
					- Engine code: K432-40
P 620, R 620 R620LA6X2/4MNA	08.06 -				- Engine code: K432-41
P 620, R 620 R620LA4X2MLB, R620LA4X2MNA, R620LA4X2MLA, R620LA4X2MNB	11.06 -				- Engine code: K432-42
					- Engine code: K432-49
P 620, R 620 R620LA6X2MNA	11.06 -				- Engine code: K432-62
R 340 R340LA6X2/4MNA	08.06 -				
R 360 R360LA6X2/4MLA, R360LA6X2/4MNA, R360LA6X2/4MNB, R360LA6X2/4MLB	04.10 -				

Vehicle list

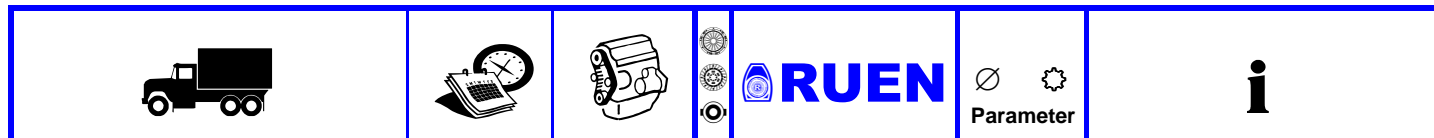

SCANIA

P, G, R, T - series 01.03 -

R 380 R380LA6X4MNA	04.04 -	DC 11.09		4300.90.112	430 24	- Engine code: K432-20
R 380	09.04 -	DC 12.13		4394.20.00	MFZ430	- Engine code: K432-62
R 380 R380LB4X2MNB, R380LB4X2MLA, R380LB4X2MLB, R380LB4X2MNA, 11700cc	04.04 -	DC 12.14 DC 12.15		4392.30.00	430WGTZ	
R 380 R380LB4X2MNB, R380LB4X2MLA, R380LB4X2MLB, R380LB4X2MNA, 11716cc	04.10 -	DC 12.18 DC 12.22		4300.90.222	430 24	- Engine code: K432-26
R 400 R400LA6X2/4MLA, R400LA6X2/4MNA, R400LA6X2/4MNB, R400LA6X2/4MLB	04.10 -	DC 13.05 DC 13.07		4394.20.00 4392.30.00 8934.40.00	430WGTZ KZISZ - 5	
R 420 R420LB6X2MNA, R420LB6X2MLA, R420LB6X2MLB, R420LB6X2MNB	03.04 -	DC 13.10 DC 13.109		4300.90.212	430 24	- Engine code: K432-27 - Engine code: K432-44
R 420 R420LB6X2*4MNA, R420LB6X2*4MNB, R420LB6X2*4MLB, R420LB6X2*4MLA	03.04 -	DC 13.110 DC 13.111		4394.20.00 4392.30.00 8934.40.00	MFZ430 430WGTZ KZISZ - 5	
R 420 R420LB8X4	03.04 -	DC 13.112 DC 13.113		4300.90.113	430 24	- Engine code: K432-33 - Engine code: K432-35 - Engine code: K432-39
R 420	03.04 -	DC 13.121 DC 13.147		4393.20.00 4393.30.00 8934.40.00	MFZ430 430WGTZ KZISZ - 5	
R 440 R440LB4X2MLB, R440LB4X2MNA, R440LB4X2MLA, R440LB4X2MNB	11.04 -	DT 12.03		4300.90.111	430 24	- Engine code: K432-36 - Engine code: K432-37
R 440 R440LB6X2MLA, R440LB6X2MNA, R440LB6X2MLB, R440LB6X2MNB	04.10 -	DT 12.06 DT 12.11		4393.20.00 4392.30.00 8934.40.00	MFZ430 430WGTZ KZISZ - 5	
R 440 R440LB8X2*6HSA	04.10 -	DT 12.12 DT 12.17		4300.90.213	430 24	- Engine code: K432-38
R 440 R440LA6X2/4MLA, R440LA6X2/4MLB, R440LA6X2/4MNB, R440LA6X2/4MNA	04.10 -			4393.20.00 4392.30.00 8934.40.00	MFZ430 430WGTZ KZISZ - 5	
R 450, Dump Truck	04.10 -			4300.90.232	430 24	- Engine code: K432-48
R 450, Platform/Chassis	09.13 -			4394.20.00 4392.30.00 8934.40.00	MFZ430 430WGTZ KZISZ - 5	
R 470 R470LB6X2MNB, R470LB6X2MLA, R470LB6X2MLB, R470LB6X2MNA	09.13 -			4300.90.214	430 24	- Engine code: K432-56
R 470, 6x2	03.04 -			4394.20.00 4394.30.00 8934.40.00	MFZ430 430WGTZ KZISZ - 5	
R 470 R470LB6X2*4MLB, R470LB6X2*4MNB, R470LB6X2*4MNA, R470LB6X2*4MLA	03.04 -			4392.30.00	430 24	- Engine code: K432-25 - Engine code: K432-41 - Engine code: K432-45 - Engine code: K432-62
R 470, 6x2/4	03.04 -				430WGTZ	
R 470 R470LA4X2MNA, R470LA4X2MNB, R470LA4X2MLA, R470LA4X2MLB	03.04 -			4393.20.00	430	- Engine code: K432-54 - Engine code: K432-55 - Engine code: K432-33 - Engine code: K432-35 - Engine code: K432-36 - Engine code: K432-37 - Engine code: K432-38 - Engine code: K432-39
R 470 R470LA6X2/4MLB, R470LA6X2/4MNA, R470LA6X2/4MLA, R470LA6X2/4MNB	03.04 -				MFZ430	
R 470 R470LA4X2MNA, R470LA4X2MNB, R470LA4X2MLA, R470LA4X2MLB	04.04 -					
R 470 R470LA6X2/4MNA	04.04 -			4394.20.00	430	- Engine code: K432-48 - Engine code: K432-56 - Engine code: K432-62
R 470 R470LA6X2MNA	04.04 -				MFZ430	
R 480 R480LB4X2MLB, R480LB4X2MNB, R480LB4X2MLA, R480LB4X2MNA	04.04 -			8948.40.00	KZIZ-5	- Engine code: K432-40 - Engine code: K432-41 - Engine code: K432-42 - Engine code: K432-49 - Engine code: K432-62
R 480 R480LB6X2MNA, R480LB6X2MNB, R480LB6X2MLA, R480LB6X2MLB	04.04 -					
R 480, 6x2	04.04 -					
R 480, 6x2/4	04.04 -					
R 480 R480LB6X2*4MLB, R480LB6X2*4MLA, R480LB6X2*4MNA, R480LB6X2*4MNB, 12742cc	04.04 -					
R 480 R480LB6X2*4MLB, R480LB6X2*4MLA, R480LB6X2*4MNA, R480LB6X2*4MNB, 11716cc	04.04 -					
R 480 R480LA4X2MLA, R480LA4X2MNA, R480LA4X2MNB	04.04 -					

Vehicle list

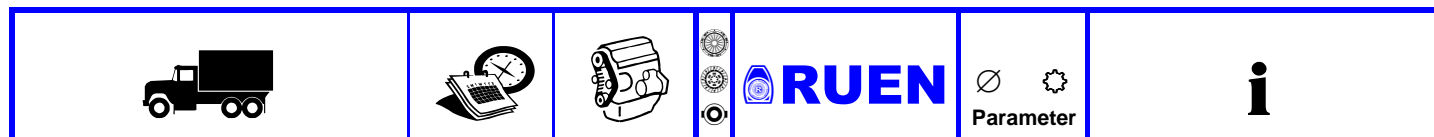

SCANIA

P, G, R, T - series 01.03 -

R 480, Platform/Chassis, 6x4	07.04 -	DC 13.07	4300.90.112	430 24	- Engine code: K432-20
R 480, Platform/Chassis, 8x4/4	07.04 -	DC 13.110	4394.20.00	MFZ430	- Engine code: K432-62
R 480, Truck Tractor, 8x4/4	07.04 -	DC 13.111	4392.30.00	430WGTZ	
R 480 R480LB4X2MLB,	04.10 -	DC 16.03	8934.40.00	KZISZ - 5	
R480LB4X2MNB, R480LB4X2MLA,		DC 16.04	4300.90.222	430 24	- Engine code: K432-26
R480LB4X2MNA		DC 16.05	4394.20.00	MFZ430	
R 480 R480LB6X2MNA,	04.10 -	DC 16.06	4392.30.00	430WGTZ	
R480LB6X2MNB, R480LB6X2MLA,		DC 16.09	8934.40.00	KZISZ - 5	
R480LB6X2MLB		DC 16.101			
R 480 R480LB8X2*6HSA, 12742cc	04.10 -	DC 16.102	4300.90.212	430 24	- Engine code: K432-27
R 480 R480LB8X2*6HSA, 11716cc	04.10 -	DC 16.18	4394.20.00	MFZ430	- Engine code: K432-44
R 480 R480LA6X2/4MNA,	04.10 -	DC 16.19	4392.30.00	430WGTZ	
R480LA6X2/4MNB		DC 16.22	8934.40.00	KZISZ - 5	
R 480, Dump Truck	10.10 -	DT 12.17	4300.90.113	430 24	- Engine code: K432-33
R 480, Truck Tractor	10.10 -		4393.20.00	MFZ430	- Engine code: K432-35
R 500 R500LB4X2MLA,	03.04 -		4393.30.00	430WGTZ	- Engine code: K432-39
R500LB4X2MNB, R500LB4X2MNA,			8934.40.00	KZISZ - 5	
R500LB4X2MLB					
R 500 R500LB6X4HHZ	03.04 -		4300.90.111	430 24	- Engine code: K432-36
R 500, 6x2	03.04 -		4393.20.00	MFZ430	- Engine code: K432-37
R 500 R500LA4X2MNA	03.04 -		4392.30.00	430WGTZ	
R 500 R500LA6X4HHZ,	03.04 -		8934.40.00	KZISZ - 5	
R500LA6X4HSZ, R500LA6X4MHZ					
R 500	03.04 -		4300.90.213	430 24	- Engine code: K432-38
R 500, Platform/Chassis	04.04 -		4393.20.00	MFZ430	
R 500 R500LA6X2/4MNA	04.04 -		4392.30.00	430WGTZ	
R 500, Truck Tractor	04.04 -		8934.40.00	KZISZ - 5	
R 500, 4x2	01.08 -		4300.90.232	430 24	- Engine code: K432-48
R 500, 6x4	01.08 -		4394.20.00	MFZ430	
R 500 R500LA6x4ESZ	03.09 -		4392.30.00	430WGTZ	
R 500 R500LA6x2/2MNA	03.09 -		8934.40.00	KZISZ - 5	
R 520, Dump Truck, 6x2/4	07.13 -		4300.90.214	430 24	- Engine code: K432-56
R 520, Platform/Chassis, 6x2/4	07.13 -		4394.20.00	MFZ430	
R 520, Platform/Chassis, 8x4/4	07.13 -		4394.30.00	430WGTZ	
R 520, Platform/Chassis, 8x4/4	07.13 -		8934.40.00	KZISZ - 5	
R 560 R560LA6X4HSZ,	03.04 -		4392.30.00	430 24	- Engine code: K432-25
R560LA6X4HHZ				430WGTZ	- Engine code: K432-41
R 560 R560LB4X2MLA,	03.04 -				- Engine code: K432-45
R560LB4X2MLB, R560LB4X2MNA,					- Engine code: K432-62
R560LB4X2MNB			4393.20.00	430	- Engine code: K432-54
R 560	04.04 -			MFZ430	- Engine code: K432-55
R 560, Platform/Chassis, 6x2	09.04 -				- Engine code: K432-33
R 560, Platform/Chassis, 6x4	09.06 -				- Engine code: K432-35
R 560, Truck Tractor, 6x2	09.06 -				- Engine code: K432-36
R 560	03.08 -				- Engine code: K432-37
R 560 R560LA6x4ESZ	03.09 -				- Engine code: K432-38
R 560 R560LA6x2/2MNA	03.09 -				- Engine code: K432-39
R 560, P 560, Dump Truck	07.09 -		4394.20.00	430	- Engine code: K432-48
R 560, P 560, Platform/Chassis	07.09 -			MFZ430	- Engine code: K432-56
R 580 R580LB6X4HHZ	03.04 -		8948.40.00	KZIZ-5	- Engine code: K432-62
R 580	03.04 -				- Engine code: K432-40
R 580 R580LA6X4MHZ,	03.04 -				- Engine code: K432-41
R580LA6X4HHZ					- Engine code: K432-42
R 580 R580LA6X2/4MNA	04.04 -				- Engine code: K432-49
R 580 R580LA6X2MNA,	04.04 -				- Engine code: K432-62
P580LA6X2MNA					
R 580, Dump Truck, 6x2	09.13 -				
R 580, Dump Truck, 6x2/4	09.13 -				



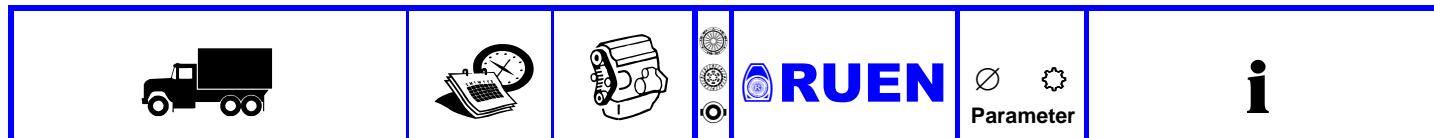



Vehicle list



SCANIA

P, G, R, T - series		01.03 -			
R 580, Dump Truck, 6x4	09.13 -	DC 16.03	4300.90.112	430 24	- Engine code: K432-20
R 580, Platform/Chassis, 6x2	09.13 -	DC 16.08	4394.20.00	MFZ430	- Engine code: K432-62
R 580, Platform/Chassis, 6x2/4	09.13 -	DC 16.102	4392.30.00	430WGTZ	
R 580, Truck Tractor, 6x2	09.13 -	DC 16.17	8934.40.00	KZISZ - 5	
R 580, Truck Tractor, 6x2/4	09.13 -	DC 16.21	4300.90.222	430 24	- Engine code: K432-26
R 580, Truck Tractor, 6x4	09.13 -	DT 16.08	4394.20.00	MFZ430	
R 580, Dump Truck	01.14 -		4392.30.00	430WGTZ	
R 580, Platform/Chassis	01.14 -		8934.40.00	KZISZ - 5	
R 580, P 580	07.09 -		4300.90.212	430 24	- Engine code: K432-27
R 620 R620LA6X4HHZ,	03.04 -		4394.20.00	MFZ430	- Engine code: K432-44
R620LA6X4HSZ			4392.30.00	430WGTZ	
R 620 R620LB8X4	03.04 -		8934.40.00	KZISZ - 5	
R 620, Platform/Chassis	10.04 -		4300.90.113	430 24	- Engine code: K432-33
R 620, Truck Tractor	10.04 -		4393.20.00	MFZ430	- Engine code: K432-35
R 620, 6x2/4	09.05 -		4393.30.00	430WGTZ	- Engine code: K432-39
R 620, Dump Truck, 6x2	11.06 -		8934.40.00	KZISZ - 5	
R 620, Dump Truck, 8x4/4	11.06 -		4300.90.111	430 24	- Engine code: K432-36
R 620, Platform/Chassis, 6x2	11.06 -		4393.20.00	MFZ430	- Engine code: K432-37
R 620, Platform/Chassis, 8x4/4	11.06 -		4392.30.00	430WGTZ	
R 620, Truck Tractor, 8x4/4	11.06 -		8934.40.00	KZISZ - 5	
R 620 R620LA4X2MNA	03.08 -		4300.90.213	430 24	- Engine code: K432-38
R 620 R620LA6x2ESZ	03.09 -		4393.20.00	MFZ430	
R 620 R620LA6x2/2MNA	03.09 -		4392.30.00	430WGTZ	
R 620 R620LA6x2/2MNA	03.09 -		8934.40.00	KZISZ - 5	
R 730, Dump Truck, 8x4/4	04.10 -		4300.90.232	430 24	- Engine code: K432-48
R 730 R730LB4X2MLA,	04.10 -		4394.20.00	MFZ430	
R730LB4X2MLB, R730LB4X2MNA,			4392.30.00	430WGTZ	
R730LB4X2MNB			8934.40.00	KZISZ - 5	
R 730, Platform/Chassis, 6x4	04.10 -		4300.90.214	430 24	- Engine code: K432-56
R 730, Platform/Chassis, 8x4/4	04.10 -		4394.20.00	MFZ430	
R 730 R730LA4X2MLB,	04.10 -		4394.30.00	430WGTZ	
R730LA4X2MNA, R730LA4X2MNB,			8934.40.00	KZISZ - 5	
R730LA4X2MLA					
R 730 R730LA6X4HSZ	04.10 -		4392.30.00	430 24	- Engine code: K432-25
R 730, Dump Truck, 6x2	10.10 -			430WGTZ	- Engine code: K432-41
R 730, Platform/Chassis, 6x2/4	10.10 -				- Engine code: K432-45
R 730, Platform/Chassis, 6x2	10.10 -				- Engine code: K432-62
R 730, Platform/Chassis, 8x4	10.10 -		4393.20.00	430	- Engine code: K432-54
R 730 R730LA6x2/2MNA	10.10 -			MFZ430	- Engine code: K432-55
R 730 R730LA6x2/4MNA	10.10 -				- Engine code: K432-33
R 730 R730LA6x2MNA	10.10 -				- Engine code: K432-35
R 730, 8x4/4	10.10 -				- Engine code: K432-36
R 730, 8x4	10.10 -				- Engine code: K432-37
R 730, 8x4	10.10 -				- Engine code: K432-38
					- Engine code: K432-39
			4394.20.00	430	- Engine code: K432-48
				MFZ430	- Engine code: K432-56
					- Engine code: K432-62
			8948.40.00	KZIZ-5	- Engine code: K432-40
					- Engine code: K432-41
					- Engine code: K432-42
					- Engine code: K432-49
					- Engine code: K432-62







Vehicle list

					
---	---	---	--	---	---













SCANIA

P, G, R, T - series







01.03 -

P 420 R 420 R 470 R 500, 6x2/4	09.04 -	DC 12.14		4325.30.00	430 24 430WGTZ	- Engine code: K423-20 - Engine code: K432-25 - Engine code: K432-26 - Engine code: K432-36 - Engine code: K432-37
	03.04 -	DC 12.15				
	09.05 -	DC 16.06				
	03.04 -	DC 16.09 DT 12.06 DT 12.11 DT 12.12			8934.40.00	KZISZ - 5
				4300.90.51  4313.20.00  4333.30.00  8934.40.00	430 24 MFZ430 430WGTZ KZISZ - 5	- Engine code: K432-33 - Engine code: K432-35 - Engine code: K432-39
				4313.20.00	430 MFZ430	- Engine code: K432-36 - Engine code: K432-37 - Engine code: K432-38

SCANIA (TÜRKIYE)









142						
142				3878.30.00	380 22 380/210GSZ	
110 - 111						
110 - 111				4201.20.00	420 G420KR	
				4235.30.00	420 10 420/210GS	
111 LBS						
111				4263.20.00	420 GMF420K	
				4235.30.00	420 10 420/210GS	
93 - 113 - 112 - 143 - K113						
112 - 113				4263.20.00	420 GMF420K	
				4261.30.00	420 22 420GSZ	
93 - 113 - 143						
143 113 - 143				4313.20.00	430 MFZ430	
				4321.30.00	430 22 430 WGTZ	
93-94 - 113 - 124 - 143 - K113						
113 - 143				4313.20.00	430 MFZ430	
				4333.30.00	430 24 430WGTZ	
94 - 124 - 144						
4 SERISI				4328.20.00	430 MFZ430	
				4333.30.00	430 24 430WGTZ	

Vehicle list

					
---	---	---	--	---	---

SCANIA (TÜRKIYE)

R SERISI (2004 - 2006)







R SERISI	01.04 - 12.06		 4300.90.51	430 24	
			 4313.20.00	MFZ430	
			 4333.30.00	430WGTZ	
			 8934.40.00	KZISZ - 5	
			 4313.20.00	430	
			 4333.30.00	430 24	
			 8934.40.00	430WGTZ	
			 8934.40.00	KZISZ - 5	

R SERISI (2006-...)



R SERISI (DC12 Mot.)	01.06 -		 8934.40.00	KZISZ - 5	
----------------------	---------	--	---	-----------	--

SISU



E

E 12			 4026.10.00	400	- This part number includes one clutch disc
			 4027.30.00	MFZ2/400X	
E 12M			 43461.30.00	400 20	
			 8995.40.00	400WGVZ	
			 43461.30.00	430 10	
			 8995.40.00	430WGTZ	
			 8995.40.00	KZIZ-6	





SK

SK 171 SK 181	10.85 -		 3860.20.00	380	
			 8500.40.00	GM380K	
			 8500.40.00	KZI - 4,5	

SL







SL 171 SL 181	10.85 -		 3860.20.00	380	
			 8500.40.00	GM380K	
			 8500.40.00	KZI - 4,5	

SM





SM Serie	08.95 -		 4303.20.00	430	- Engine code: CumminsN11, 14
			 4300.30.00	MFZ430	
			 8916.40.00	430 10	- Engine code: CumminsN11, 14
			 8916.40.00	430GTZ	
			 8916.40.00	KZIZ - 5	- Engine code: CumminsN11, 14

STEYR

Pinzgauer

Pinzgauer 712 Pinzgauer 720			 2400.20.00	240	
			 2400.30.00	MF240	
Pinzgauer 716, 717			 2400.20.00	240 10	
			 2400.20.00	240PSD	
			 2400.20.00	240	
			 2400.20.00	MF240	

SL

SL 10 H 210 , 9 G			 3804.20.00	380	- Engine code: 4F
			 3861.30.00	G380KR	
			 7951.40.00	380 10	- Engine code: 4F
			 7951.40.00	380W2GSZ	
			 7951.40.00	KZIS - 4	- Engine code: 4F







Vehicle list



STEYR







TG-A						
18 S 31 18 S 36 18 S 41	04.00 -	D 2866 LF26		4300.90.20	430 10	- Engine code: D2866LF26...LF28
	04.00 -	D 2866 LF27		4319.20.00	MFZ430	- Engine code: D2866LF32
	04.00 -	D 2866 LF28		4346.30.00	430WGTZ	- Engine code: D2866LF36...LF37
		D 2866 LF32		8916.40.00	KZIZ - 5	- GBox: ZF Ecosplit-3
		D 2866 LF36 D 2866 LF37		4028.10.00	400 MFZ2/400X	- Engine code: D2866LF26...LF28 - Engine code: D2866LF32 - Engine code: D2866LF36...LF37 - GBox: ZF Ecosplit-3
				8941.40.00	KZISZ-5	- Engine code: D2866LF26...LF28 - Engine code: D2866LF32 - Engine code: D2866LF36...LF37 - GBox: ZF Ecosplit-3
				4300.90.13	430 10	- Engine code: D2866LF26...LF28
				4319.20.00	MFZ430	- Engine code: D2866LF32
				4346.30.00	430WGTZ	- Engine code: D2866LF36...LF37
				8919.40.00	KZISZ - 5	- GBox: AS-Tronik
				4300.90.56	430 10	- Engine code: D2866LF26...LF28
				4319.20.00	MFZ430	- Engine code: D2866LF32
				4346.30.00	430WGTZ	- Engine code: D2866LF36...LF37
				8939.40.00	KZISZ - 5	- GBox: AS-Tronic
18 S 46 18 S 51	04.00 -	D 2676 LF05		4300.90.53	430 10	- Engine code: D2676LF05
	04.00 -	D 2876 LF 04		4339.20.00	MFZ430	- Engine code: D2876LF04, 07, 08
		D 2876 LF07		4386.30.00	430WGTZ	- GBox: ZF Ecosplit-3
		D 2876 LF08		8916.40.00	KZIZ - 5	
				4028.10.00	400 MFZ2/400X	- Engine code: D2676LF05 - Engine code: D2876LF04, 07, 08 - GBox: ZF Ecosplit-3
				8941.40.00	KZISZ-5	- Engine code: D2676LF05 - Engine code: D287604, 07, 08 - GBox: ZF Ecosplit-3
				4300.90.12	430 10	- Engine code: D2676LF05
				4339.20.00	MFZ430	- Engine code: D2876LF04, 07, 08
				4386.30.00	430WGTZ	- GBox: ZF Astronik
				8919.40.00	KZISZ - 5	
26 S 31 26 S 36	09.00 -	D 2866 LF26		4300.90.20	430 10	- Engine code: D2866LF26, 27, 36, 37
	09.00 -	D 2866 LF27		4319.20.00	MFZ430	- GBox: ZF Ecosplit-3
		D 2866 LF36		4346.30.00	430WGTZ	
		D 2866 LF37		8916.40.00	KZIZ - 5	
				4028.10.00	400 MFZ2/400X	- Engine code: D2866LF26, 27, 36, 37 - GBox: ZF Ecosplit-3
				8941.40.00	KZISZ-5	- Engine code: D2866LF26, 27, 36, 37 - GBox: ZF Ecosplit-3
				4300.90.13	430 10	- Engine code: D2866LF26, 27, 36, 37
				4319.20.00	MFZ430	- GBox: ZF-AS-Tronic
				4346.30.00	430WGTZ	
				8919.40.00	KZISZ - 5	
				4300.90.56	430 10	- Engine code: D2866LF26, 27, 36, 37
				4319.20.00	MFZ430	- GBox: ZF-AS-Tronic
				4346.30.00	430WGTZ	
				8939.40.00	KZISZ - 5	
6...						
6 S 10				3300.90.08	330 10	- Engine code: D0824FL,LFL
				3313.20.00	MFZ330	- To model year: 03.1996
				3309.30.00	330GSZ	
				3620.90.10	362 10	- Engine code: D0824FL,LFL
				3610.20.00	MFZ362	
				3610.30.00	362GTZ	

Vehicle list



					
---	---	---	--	---	---

STEYR





















6...

6 S 16			 3300.90.08	330 10 MFZ330 330GSZ	- Engine code: D0824LFL - To model year: 03.1996
			 3313.20.00  3309.30.00		
			 3620.90.10	362 10 MFZ362 362GTZ	- Engine code: D0824LFL
			 3610.20.00		
			 3610.30.00		











7...

7 G 1 F-K 7 GA 1 F-K			 3804.20.00	380 G380KR	
			 7951.40.00		







8...

8 S 10			 3300.90.08	330 10 MFZ330 330GSZ	- Engine code: D0824FL,LFL - To model year: 03.1996				
			 3313.20.00  3309.30.00						
			 3620.90.10			362 10 MFZ362 362GTZ	- Engine code: D0824FL,LFL		
 3610.20.00									
 3610.30.00									
8 S 15 8 S 16			 3300.90.08	330 10 MFZ330 330GSZ	- Engine code: D0824LFL - To model year: 03.1996				
			 3313.20.00  3309.30.00						
			 3620.90.10			362 10 MFZ362 362GTZ	- Engine code: D0824LFL		
 3610.20.00									
 3610.30.00									
8 S 22			 3500.90.04	350 10 MF350 350GSZ KZIS - 3	- Engine code: D0826LFL - To model year: 02.1994				
			 3573.20.00  3587.30.00  6905.40.00						
			 3573.20.00			350 MF350	- Engine code: D826LFL - From model year: 03.1994		
			 3587.30.00					350 10 350GSZ	- Engine code: D0826LFL - From model year: 03.1994
			 6905.40.00						
 6905.40.00									

9...







9 G 4 F-K 9 GNFNA-L			 3804.20.00	380 G380KR	
			 7951.40.00		
9 S 15 9 S 16			 3300.90.08	330 10 MFZ330 330GSZ	- Engine code: D0824LFL - To model year: 03.1996
			 3313.20.00  3309.30.00		
			 3620.90.10		
 3610.20.00					
 3610.30.00					
9 S 18			 3577.30.00	350 10 350WGSZ	- Engine code: WD612.71, 73
			 3163.30.00		

Vehicle list















					
---	---	---	--	---	---

STEYR















9...

9 S 22			 3500.90.04	350 10	- Engine code: D0826ifl - To model year: 02.1994
			 3573.20.00	MF350	
			 3587.30.00	350GSZ	
			 6905.40.00	KZIS - 3	
			 3573.20.00	350	- Engine code: D0826LFL - From model year: 03.1994
			 3587.30.00	350 10	- Engine code: D0826LFL - From model year: 03.1994
			 6905.40.00	KZIS - 3	- Engine code: D0826LFL - From model year: 03.1994







10...

10 S 15 10 S 16			 3300.90.08	330 10	- Engine code: D0824LFL - To model year: 03.1996
			 3313.20.00	MFZ330	
			 3309.30.00	330GSZ	
			 3620.90.10	362 10	- Engine code: D0824LFL
			 3610.20.00	MFZ362	
			 3610.30.00	362GTZ	
10 S 18			 3577.30.00	350 10	- Engine code: WD612.71, 73 350WGSZ
10 S 22			 3500.90.04	350 10	- Engine code: D0826LFL - To model year: 02.1994
			 3573.20.00	MF350	
			 3587.30.00	350GSZ	
			 6905.40.00	KZIS - 3	
			 3573.20.00	350	- Engine code: D0826LFL - From model year: 03.1994
			 3587.30.00	350 10	- Engine code: D0826LFL - From model year: 03.1994
			 6905.40.00	KZIS - 3	- Engine code: D0826LFL - From model year: 03.1994







11...

11 S 15 11 S 16	- 03.96 - 03.96		 3300.90.08	330 10	- Engine code: D0824LFL
			 3313.20.00	MFZ330	
			 3309.30.00	330GSZ	
			 3620.90.10	362 10	- Engine code: D0824LFL
			 3610.20.00	MFZ362	
			 3610.30.00	362GTZ	
11 S 15 (T72) 11 S 16 (T72)	04.96 - 04.96 -		 3950.90.02	395 10	- Engine code: D0824LFL
			 3956.20.00	MFZ395	
			 3951.30.00	395WGTZ	
			 8535.40.00	KZIZ - 4,5	
			 3620.90.10	362 10	- Engine code: D0824LFL
			 3610.20.00	MFZ362	
			 3610.30.00	362GTZ	
11 S 18			 3163.30.00	310 10	- Engine code: WD612.63 310GTD

















































12...

12 S 15 12 S 16	- 03.96 - 03.96		 3300.90.08	330 10	- Engine code: D0824LFL
			 3313.20.00	MFZ330	
			 3309.30.00	330GSZ	
			 3620.90.10	362 10	- Engine code: D0824LFL
			 3610.20.00	MFZ362	
			 3610.30.00	362GTZ	







Vehicle list

					
---	---	---	--	---	---







































STEYR

12...					
12 S 15 (T72) 12 S 16 (T72)	04.96 - 04.96 -		 3950.90.02  3956.20.00  3951.30.00  8535.40.00	395 10 MFZ395 395WGTZ KZIZ - 4,5	- Engine code: D0824LFL
			 3620.90.10  3610.20.00  3610.30.00	362 10 MFZ362 362GTZ	- Engine code: D0824LFL
12 S 18			 3577.30.00	350 10 350WGSZ	- Engine code: WD612.71, 73
12 S 21			 3857.30.00	380 10 380W2GSZ	- Engine code: WD612.75
12 S 22 12 S 26	- 01.96 - 01.96		 3950.90.02  3956.20.00  3951.30.00  8535.40.00	395 10 MFZ395 395WGTZ KZIZ - 4,5	- Engine code: D0826
13...					
13 S 15 13 S 16	- 03.96 - 03.96		 3300.90.08  3313.20.00  3309.30.00	330 10 MFZ330 330GSZ	- Engine code: D0824LFL
			 3620.90.10  3610.20.00  3610.30.00	362 10 MFZ362 362GTZ	- Engine code: D0824LFL
13 S 15 (T72) 13 S 16 (T72)	04.96 - 04.96 -		 3950.90.01  3952.20.00  3960.30.00	395 18 MF395 395GTZ	- Engine code: D0824LFL
			 3620.90.10  3610.20.00  3610.30.00	362 10 MFZ362 362GTZ	- Engine code: D0824LFL
13 S 18			 3163.30.00	310 10 310GTD	- Engine code: WD612.63
13 S 22 13 S 26	01.96 - 01.96 -		 3950.90.02  3956.20.00  3951.30.00  8535.40.00	395 10 MFZ395 395WGTZ KZIZ - 4,5	- Engine code: D0826
14...					
14 S 15 14 S 16	- 03.96 - 03.96		 3300.90.08  3313.20.00  3309.30.00	330 10 MFZ330 330GSZ	- Engine code: D0824LFL
			 3620.90.10  3610.20.00  3610.30.00	362 10 MFZ362 362GTZ	
14 S 15 (T72) 14 S 16 (T72)	04.96 - 04.96 -		 3950.90.02  3956.20.00  3951.30.00  8535.40.00	395 10 MFZ395 395WGTZ KZIZ - 4,5	- Engine code: D0824LFL
			 3620.90.10  3610.20.00  3610.30.00	362 10 MFZ362 362GTZ	- Engine code: D0824LFL
14 S 18			 3577.30.00	350 10 350WGSZ	- Engine code: WD6412.71, 73
14 S 21			 3857.30.00	380 10 380W2GSZ	- Engine code: WD612.75
14 S 22 14 S 26	01.96 - 01.96 -		 3950.90.02  3956.20.00  3951.30.00  8535.40.00	395 10 MFZ395 395WGTZ KZIZ - 4,5	- Engine code: D0826







Vehicle list

					
---	---	---	--	---	---







































STEYR

15...						
15 S 15	- 03.96			3300.90.08	330 10	- Engine code: D0824LFL
15 S 16	- 03.96		 	3313.20.00 3309.30.00	MFZ330 330GSZ	
				3620.90.10	362 10	- Engine code: D0824LFL
			 	3610.20.00 3610.30.00	MFZ362 362GTZ	
15 S 15 (T72)	04.96 -			3950.90.02	395 10	- Engine code: D0824LFL
15 S 16 (T72)	04.96 -		  	3956.20.00 3951.30.00 8535.40.00	MFZ395 395WGTZ KZIZ - 4,5	
				3620.90.10	362 10	- Engine code: D0824LFL
			 	3610.20.00 3610.30.00	MFZ362 362GTZ	
15 S 18				3577.30.00	350 10	- Engine code: WD612.71, 73
				3163.30.00	310 10	- Engine code: WD612.63
					310GTD	
15 S 21				3857.30.00	380 10	- Engine code: WD612.75
					380W2GSZ	
15 S 22	01.95 -			3950.90.02	395 10	- Engine code: D0826
15 S 26	01.95 -		  	3956.20.00 3951.30.00 8535.40.00	MFZ395 395WGTZ KZIZ - 4,5	
16...						
16 S 18				3577.30.00	350 10	- Engine code: Wd612.71, 73
					350WGSZ	
16 S 21				3857.30.00	380 10	- Engine code: WD612.75
					380W2GSZ	
17...						
17 S 18				3163.30.00	310 10	- Engine code: WD612.63
					310GTD	
18...						
18 S 26				3857.30.00	380 10	- Engine code: WD612.34
					380W2GSZ	
19...						
19 S 29	01.94 - 01.00	D 2865 LF20		4300.90.49	430 10	- Engine code: D2865LF20, 21, 24
19 S 34	01.94 - 01.00	D 2865 LF21 D 2865 LF24	  	4301.20.00 4346.30.00 8916.40.00	MFZ430 430WGTZ KZIZ - 5	
19 S 31				4250.20.00	420	- Engine code: WD615.68, 78
				4240.30.00	420 10	- Engine code: WD615.68, 78
				8508.40.00	420/210GSZ	- Engine code: WD615.68, 78
					KZI - 4,5	- Engine code: WD615.68, 78
19 S 40				4028.10.00	400	- Engine code: D2840
19 S 46				8941.40.00	MFZ2/400X	- Engine code: D2840
				4301.20.00	430	- Engine code: D2866
				4305.30.00	MFZ430	- Engine code: D2866
				8916.40.00	430 10	- Engine code: D2866
					430W2GTZ	- Engine code: D2866
					KZIZ - 5	- Engine code: D2866







Vehicle list

					
---	---	---	--	---	---

































STEYR

22...						
22 S 31			 4250.20.00	420 GFX420KR	- Engine code: WD615.68, 78	
			 4240.30.00	420 10 420/210GSZ	- Engine code: WD615.68, 78	
			 8508.40.00	KZI - 4,5	- Engine code: WD615.68, 78	
23...						
23 S 34	01.94 -		 4300.90.49	430 10 MFZ430 430WGTZ KZIZ - 5		
			 4301.20.00			
			 4346.30.00			
			 8916.40.00			
23 S 40 23 S 46	01.94 - 01.94 -		 4301.20.00	430 MFZ430	- Engine code: D2866, 2876	
			 4305.30.00	430 10 430W2GTZ	- Engine code: D2866, 2876	
			 8916.40.00	KZIZ - 5	- Engine code: D2866, 2876	
25...						
25 S 22 25 S 26	06.95 - 06.95 -		 3950.90.02	395 10 MFZ395 395WGTZ KZIZ - 4,5	- Engine code: D0826LF	
			 3956.20.00			
			 3951.30.00			
			 8535.40.00			
26...						
26 S 29			 4300.90.49	430 10 MFZ430 430WGTZ KZIZ - 5		
			 4301.20.00			
			 4346.30.00			
			 8916.40.00			
26 S 31			 4250.20.00	420 GFX420KR	- Engine code: WD615.68, 78	
			 4240.30.00	420 10 420/210GSZ	- Engine code: WD615.68, 78	
26 S 34			 4300.90.49	430 10 MFZ430 430WGTZ KZIZ - 5		
			 4301.20.00			
			 4346.30.00			
			 8916.40.00			
26 S 40 26 S 46			 4300.90.49	430 10 MFZ430 430WGTZ KZIZ - 5		
			 4301.20.00			
			 4346.30.00			
			 8916.40.00			
32...						
32 S 31			 4250.20.00	420 GFX420KR	- Engine code: WD615.68, 78	
			 4240.30.00	420 10 420/210GSZ	- Engine code: WD615.68, 78	
			 8508.40.00	KZI - 4,5	- Engine code: WD615.68, 78	
32 S 34			 4250.20.00	420 GFX420KR	- Engine code: WD815.74	
			 4257.30.00	420 10 420GSZ	- Engine code: WD815.74	
			 8508.40.00	KZI - 4,5	- Engine code: WD815.74	
33...						
33 S 40			 4300.90.49	430 10 MFZ430 430WGTZ KZIZ - 5		
			 4301.20.00			
			 4346.30.00			
			 8916.40.00			

Vehicle list

					
---	---	---	--	---	---

STEYR

33...						
33 S 46				4028.10.00	400 MFZ2/400X	- Engine code: D2840
				8941.40.00	KZISZ-5	- Engine code: D2840
				4301.20.00	430 MFZ430	- Engine code: D2876
				4305.30.00	430 10 430W2GTZ	- Engine code: D2876
				8916.40.00	KZIZ - 5	- Engine code: D2876
35...						
35 S 36	06.98 -	D 2866 LF31		4300.90.05	430 10 MFZ430	- Engine code: D2866LF31, 35
35 S 41	06.98 -	D 2866 LF35		4301.20.00	430WGTZ	
				4346.30.00	KZIZ - 5	
				8916.40.00		
41...						
41 S 36	06.98 -	D 2866 LF20		4300.90.05	430 10 MFZ430	- Engine code: D2866LF30, 31, 35
41 S 40	06.95 -	D 2866 LF31		4301.20.00	430WGTZ	- Engine code: D2876LF02, 03
41 S 41	06.98 -	D 2866 LF35		4346.30.00	KZIZ - 5	
41 S 46	08.95 -	D 2876 LF 02		8916.40.00		
		D 2876 LF 03				
42...						
42 S 40				4301.20.00	430 MFZ430	- Engine code: D2866
42 S 46				4305.30.00	430 10 430W2GTZ	- Engine code: D2866
				8916.40.00	KZIZ - 5	- Engine code: D2866
60 - 991						
780 E				3131.20.00	310 G310	- Engine code: Ladermot.
				3101.30.00	310 10 310GSZ	- Engine code: Ladermot.
791				3529.20.00	350 GF350KR	
				3577.30.00	350 10 350WGSZ	
				7951.40.00	KZIS - 4	- Engine code: WD612.00, 20, 60, 67, 70, 77, 90
880 Z				3506.20.00	350 G350	
				3588.30.00	350 10 350GSZ	
890 990				3506.20.00	350 G350	- Engine code: 614.01
				3516.30.00	350 10 350WGSZ	- Engine code: 614.01
				7951.40.00	KZIS - 4	- Engine code: 614.01
891				3529.20.00	350 GF350KR	- Engine code: WD612.60
				3577.30.00	350 10 350WGSZ	- Engine code: WD612.60
				7951.40.00	KZIS - 4	- Engine code: WD612.60
990 4x4				3506.20.00	350 G350	- Engine code: 614.20
				3516.30.00	350 10 350WGSZ	- Engine code: 614.20
				7951.40.00	KZIS - 4	- Engine code: 614.20

Vehicle list



STEYR







60 - 991

991		3819.20.00	380 GF380KR	- Engine code: WD615.00, 20
		3857.30.00	380 10 380W2GSZ	- Engine code: WD615.00, 20
		7951.40.00	KZIS - 4	- Engine code: WD615.20,20

1090 - 2891



















1090 , a		3506.20.00	350 G350	- Engine code: WD610.42
1100 , a		3506.20.00	350 G350	- Engine code: WD610.40
1108 , a		3506.20.00	350 G350	- Engine code: WD610.44
1200 , a		3506.20.00	350 G350	- Engine code: WD610.43
1290, 169kW		3819.20.00	380 GF380KR	- Engine code: wd614.60, 70
		3861.30.00	380 10 380W2GSZ	- Engine code: wd614.60, 70
		7951.40.00	KZIS - 4	- Engine code: wd614.60, 70
1290, 235kW 1490, 235kW		4296.20.00	420 GF420	- Engine code: WD815.60, V8
		7951.40.00	KZIS - 4	- Engine code: WD815.60, V8
1290 1490		4296.20.00	420 GF420	- Engine code: WD815.00, 60-320PS
		4258.30.00	420 10 420GSZ	- Engine code: WD815.00, 60-320PS
		7951.40.00	KZIS - 4	- Engine code: WD815.00, 60-320PS
1291 1491		4296.20.00	420 GF420	- Engine code: WD615.61, 65, 66, 67, 69, 71, 75, 77 - Engine code: WD815.61, 63, 71
		4240.30.00	420 10 420/210GSZ	- Engine code: WD615.61, 65, 66, 67, 69, 71, 75, 77 - Engine code: WD615.78 - GBox: ZF 16 S 130
		8508.40.00	KZI - 4,5	- Engine code: WD615.61, 65, 66, 67, 69, 71, 75, 77 - Engine code: WD615.78 - GBox: ZF 16 S 130 - Engine code: WD815.61, 63, 71 - Engine code: WD815.62, 64, 74 - Engine code: WD815.67, 68, 97
		3819.20.00	380 GF380KR	- Engine code: WD615.60, 70
		3857.30.00	380 10 380W2GSZ	- Engine code: WD615.60, 70
		7951.40.00	KZIS - 4	- Engine code: WD615.60, 70
		4250.20.00	420 GFX420KR	- Engine code: WD615.78 - GBox: ZF 16 S 130 - Engine code: WD815.62, 64, 74
		4257.30.00	420 10 420GSZ	- Engine code: WD815.61, 63, 71 - Engine code: WD815.62, 64, 74 - Engine code: WD815.67, 68, 97
		4244.20.00	420 GFX420KR	- Engine code: WD815.67, 68, 97
	1391		3529.20.00	350 GF350KR
		3577.30.00	350 10 350WGSZ	- Engine code: WD612.60
		7951.40.00	KZIS - 4	- Engine code: WD612.60

Vehicle list

					
---	---	---	--	---	---









STEYR

1090 - 2891







1490, 169kW		3819.20.00	380 GF380KR	- Engine code: WD614.60
		3861.30.00	380 10 380W2GSZ	- Engine code: WD614.60
		7951.40.00	KZIS - 4	- Engine code: WD614.60
1891		4296.20.00	420 GF420	- Engine code: WD615.61, 65, 66, 67, 69, 71, 75, 77 - Engine code: WD815.61, 63, 71
		4240.30.00	420 10 420/210GSZ	- Engine code: WD615.61, 65, 66, 67, 69, 71, 75, 77
		8508.40.00	KZI - 4,5	- Engine code: WD615.61, 65, 66, 67, 69, 71, 75, 77 - Engine code: WD815.61, 63, 71 - Engine code: WD815.62, 64, 74 - Engine code: WD815.67, 68, 97
		4257.30.00	420 10 420GSZ	- Engine code: WD815.61, 63, 71 - Engine code: WD815.62, 64, 74 - Engine code: WD815.67, 68, 97
		4250.20.00	420 GFX420KR	- Engine code: WD815.62, 64, 74
		4244.20.00	420 GFX420KR	- Engine code: WD815.67, 68, 97
1920		3819.20.00	380 GF380KR	- Engine code: WD614e
		3861.30.00	380 10 380W2GSZ	- Engine code: WD614e
		7951.40.00	KZIS - 4	- Engine code: WD614e
2891		4296.20.00	420 GF420	- Engine code: WD615.61, 65, 66, 67, 69, 71, 75, 77
		4240.30.00	420 10 420/210GSZ	- Engine code: WD615.61, 65, 66, 67, 69, 71, 75, 77 - Engine code: WD615.92, 93
		8508.40.00	KZI - 4,5	- Engine code: WD615.61, 65, 66, 67, 69, 71, 75, 77 - Engine code: WD615.92, 93 - Engine code: WD815.67, 68, 97
		4250.20.00	420 GFX420KR	- Engine code: WD315.92, 93
		4244.20.00	420 GFX420KR	- Engine code: WD815.67, 68, 97
		4257.30.00	420 10 420GSZ	- Engine code: WD815.67, 68, 97

TAM































NKW

75 A5,6 75 T3B,4B 75 T5B,BK		2802.20.00	280 G280	
		2803.30.00	280 6 280BHZ	
		6606.40.00	KFL - 555	
110 T-10 130 T11B,FE, PR, SM, SN2.9, HL, CC,CM3.2		3107.20.00	310 GF310K	
		3102.30.00	310 10 310GSZ	
		7200.40.00	FKL - 306.770L	
122 T8		3164.20.00	310 MF310	
		3130.30.00	310 10 310W2GSZ	
		6907.40.00	KZI - 3	







Vehicle list

					
---	---	---	--	---	---

TAM

NKW					
125 T10,12 125 T12 4x4 5500 5500,G 5500 DK,QG 6500 K,GO 6500 SN,BVL			 3540.20.00	350 LA350	
			 3552.30.00	350 10 350	
150 T11B 6x6 150 T11BV 6x6			 3502.20.00	350 G350KR	
			 3502.30.00	350 10 350GSZ	
			 6907.40.00	KZI - 3	
190 T15 3,5 190 T15 4,1 190 T15 4x4 3,5 190 TBK 3,5			 3802.20.00	380 G380KR	
			 3857.30.00	380 10 380W2GSZ	
			 8500.40.00	KZI - 4,5	
260 T17 260 T22 6x4 260 T26 6x4 3,2 260 T26 6x4 4,7			 4201.20.00	420 G420KR	
			 4250.30.00	420 10 420WGSZ	
2000K, N, GF, SB PIONIR			 2801.20.00	280 G280	
			 2803.30.00	280 6 280BHZ	
			 6606.40.00	KFL - 555	
60 T3 B, T4 B, T5 B 2000, 2001, H, N, HS, CB, GF			 2803.20.00	280 G280	
			 2803.30.00	280 6 280BHZ	
			 6606.40.00	KFL - 555	
5000 5000 5000 DC,HS,DVC 5000 F,K,P			 2802.20.00	280 G280	
			 2802.30.00	280 10 280BHZ	
80 T6 B,T35 E2.6, T50 F3.2, T50KR3.2,... 100 T8 B			 2821.20.00	280 MF280K	
			 2821.30.00	280 10 280GTZ	
			 6606.40.00	KFL - 555	
90 VM 50			 2821.20.00	280 MF280K	
			 2821.30.00	280 10 280GTZ	
110 T7 B4x4, BV4x4 130 T10 4x4, T11B			 3102.20.00	310 GF310K	
			 3102.30.00	310 10 310GSZ	
			 6907.40.00	KZI - 3	
170 T14, T14 4x4			 3801.20.00	380 G380KR	
			 3802.30.00	380 10 380GSZ	
			 8401.40.00	KZI - 4,5	
331 T17			 4253.20.00	420 GFX420KR	
			 4250.30.00	420 10 420WGSZ	

Vehicle list

					
---	---	---	--	---	---

TATRA









T 815

T 815				4293.30.00	420 10 420GSZ	
-------	--	--	---	-------------------	-------------------------	--

VOLVO



















F 6 S

01.80 - 12.85

F 6 S	01.78 -	TD 60		3800.90.10	380 10 GM380K 380GSZ KZA - 4	- GBox: S 6-65
				3860.20.00		
				3886.30.00		
				5902.40.00		
				3800.90.48	380 10 GM380K 380GSZ KZA - 4	- GBox: R52, R52B
				3860.20.00	380 GM380K	
	3886.30.00	380 10 380GSZ				
	7802.40.00	KZA - 4				





F 7

08.78 - 12.85







F 7, 16t, Platform/Chassis F 7, 22t, Platform/Chassis F 7, Truck Tractor F 7, Dump Truck	08.78 - 12.85	TD 70 F TD 70 FS TD 70 G		3800.90.49	380 10 G380KR 380GSZ KZA - 4	- From chassis no.: 2162 - GBox: R52
				3803.20.00		
				3886.30.00		
				7802.40.00		
				3800.90.48	380 10 GM380K 380GSZ KZA - 4	- From chassis no.: 2163
				3860.20.00		
				3886.30.00		
				7802.40.00		
				3500.90.01	350 10 GF2/350 350GSZ KZA - 4	- GBox: R52
				3511.10.00		
				3590.30.00	350 G350KR	
				3559.30.00	350 10 350GSZ	
				3590.30.00	350 10 350GSZ	- Loose clutch disc - GBox: R52
				5902.40.00	KZA - 4	- GBox: R52
	3515.10.00	350 GF2/350	- This part number includes one clutch disc - GBox: R52			
	3515.50.00	350 GF2-350	- GBox: R52			
	3515.20.00	350 GF2/350				
	8901.40.00	KZI - 5				

F 10

























08.77 - 12.94

Mot. TD 100 Volvo KF215L, Volvo KF215K	01.77 -			3890.10.00	380 GF2/380	- This part number includes one clutch disc - GBox: MR62
				3839.30.00	380 10 380GSZ	- GBox: MR62 - Loose clutch disc - GBox: MR62B
				8901.40.00	KZI - 5	- GBox: MR62 - GBox: MR62B
				3808.30.00	380 10 380GSZ	- GBox: MR62 - GBox: MR62B

Vehicle list

					
---	---	---	--	---	---

VOLVO

F 10		08.77 - 12.94			
Mot. TD 100, 101 Volvo KF116B, Volvo KF214F,H	01.77 -		 3515.20.00	350 GF2/350	
			 3500.90.03  3516.10.00  3561.30.00  8901.40.00	350 10 GF2/350 350GSZ KZI - 5	- GBox: R/SR62
Mot. TD 101, 102, 103 Volvo KFD214A, Volvo KFD117B,C	01.83 -		 4300.90.21 ⊕  4332.60.00  4323.30.00	430 10 MFZ430 430WGTZ	- GBox: R/SR1400, 1700
			 4300.90.76 ⊕  4332.60.00  4336.30.00	430 10 MFZ430 430GTZ	- GBox: R/SR1400, 1700
			 4336.30.00	430 10 430GTZ	
			 8925.40.00	KZISZ-5	
			 8946.46.00	KZIZ-5	
F 12		08.77 - 12.94			
Mot. TD 121, 122, 123 Volvo KFD214A, Volvo KFD215A	01.83 -		 8929.46.00	KZIZ-5	- GBox: R/SR1400, 1700
			 3800.90.11  3890.10.00  3839.30.00  8901.40.00	380 10 GF2/380 380GSZ KZI - 5	
Mot. TD 122, 123 Volvo KFD117D	01.87 -		 4300.90.33 ⊕  4332.60.00  4331.30.00	430 10 MFZ430 430WGTZ	- GBox: R/SR1400, 1700
			 8946.46.00	KZIZ-5	
			 8925.40.00	KZISZ-5	

Vehicle list

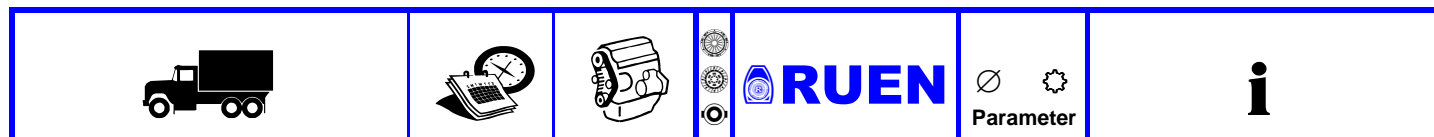































VOLVO

F 12		08.77 - 12.94			
F 12/360, 17t, 4x2	01.88 - 12.90	TD 121 F	4300.90.33 ⊕	430 10	- GBox: R/SR1400, 1700
	01.88 - 12.90	TD 122 F	4332.60.00	MFZ430	
F 12/360, 24t, 6x2	01.88 - 12.90	TD 122 FH	4331.30.00	430WGTZ	
F 12/360, 24t, 6x4	01.88 - 12.90	TD 122 FL			
F 12/360, 17t, 4x2	01.88 - 12.90	TD 122 FS			
F 12/360, 24t, 6x2	01.88 - 12.90	TD 123 ES			
F 12/360, 24t, 6x4	01.88 - 12.90				
F 12/360, 25t, 6x4	10.90 - 12.94				
F 12/360, 18t, 4x2	12.90 - 12.94				
	12.90 - 12.94				
F 12/360, 25t, 6x2	12.90 - 12.94				
F 12/360, 25t, 6x4	12.90 - 12.94				
F 12/360, 18t, 4x2	12.90 - 12.94				
F 12/360, 25t, 6x2	12.90 - 12.94				
F 12/360, 26t, 6x4	01.91 - 12.94				
F 12/370	08.77 - 12.86				
F 12/400, 17t, 4x2	01.88 - 12.90				
F 12/400, 24t, 6x2	01.88 - 12.90				
F 12/400, 24t, 6x4	01.88 - 12.90				
F 12/400, 17t, 4x2	01.88 - 12.90				
F 12/400, 24t, 6x4	01.88 - 12.90				
F 12/400, 18t, 4x2	12.90 - 12.94				
F 12/400, 25t, 6x2	12.90 - 12.94				
F 12/400, F 12/410	01.88 - 12.94				
F 12/400, F 12/410, 25t, 6x2	12.90 - 12.94				
F 12/400, F 12/410, 25t, 6x4	12.90 - 12.94				
F 12/400, F 12/410, 18t, 4x2	12.90 - 12.94				
F 12/400, F 12/410, 25t, 6x4	12.90 - 12.94				
Mot. TD 120 Volvo KF215K	01.77 -		3849.20.00	380 G380KR	- GBox: MR62B
			3808.30.00	380 10 380GSZ	- GBox: MR62B
			3839.30.00	380 10 380GSZ	- GBox: MR62B
			8901.40.00	KZI - 5	- GBox: MR62B
Mot. TD 120, 121 Volvo KF215D,G, Volvo KF215F	01.77 -		38104.30.00	380 10 380GTZ	- GBox: R/SR70,71
			38105.30.00	380 10 380GTZ	- GBox: R/SR70,71
			8901.40.00	KZI - 5	- GBox: R/SR70,71
			38101.30.00	380 10 380GVZ	- GBox: R/SR70,71 - Loose clutch disc
			3890.10.00	380 GF2/380	- GBox: SR62 - GBox: R/SR70 - This part number includes one clutch disc
			3839.30.00	380 10 380GSZ	- GBox: SR62 - GBox: R/SR70 - Loose clutch disc
			3892.20.00	380 GF2/380	- GBox: SR62 - GBox: R/SR70
			3808.30.00	380 10 380GSZ	- GBox: SR62 - GBox: R/SR70
			38102.30.00	380 10 380GVZ	- GBox: R/SR70,71
F 16		10.87 - 12.94			
Mot. TD 162, 163 Volvo KFD216A	01.87 -		8929.46.00	KZIZ-5	- To chassis no.: 382112 - GBox: SR2000

Vehicle list

					
---	---	---	--	---	---













VOLVO

F 16		10.87 - 12.94	
Mot. TD 162, 163 Volvo KFD216A			8929.46.00 KZIZ-5 - From chassis no.: 382113 - GBox: SR2000
F 86			
F 86 über 32 t Gesamtgewicht			3500.90.51 350 10 GF2/350 350GSZ KZA - 4
			3516.10.00
			3562.30.00
			5902.40.00
			3500.90.01 350 10 GF2/350 350GSZ KZA - 4
			3511.10.00
			3590.30.00
			5902.40.00
F 86			3803.20.00 380 G380KR - Engine code: TD 70 B, E - GBox: R 51
			7802.40.00 KZA - 4 - Engine code: TD 70 B, E - GBox: R 51
F 88			
F 88			3889.10.00 380 GF2/380 - GBox: MR 61
			3870.30.00 380 10 380/210GSZ - Loose clutch disc
			3892.20.00 380 GF2/380
			3848.50.00 380 GF2/380
			3871.30.00 380 10 380/70GSZ
			8901.40.00 KZI - 5
			3515.10.00 350 GF2/350 - GBox: R 61, SR 61
			3562.30.00 350 10 350GSZ - Loose clutch disc
			3516.20.00 350 G350KR
			3515.50.00 350 GF2-350
			3530.30.00 350 10 350GSZ - Contained in xxxx.10.00
			4200.90.71 420 10 G420KR 420GSZ KZI - 5
			4203.20.00
			4254.30.00
			8900.40.00
F 88 T			4200.90.71 420 10 G420KR - Chassis no.: 254 420GSZ - Chassis no.: 269 KZI - 5
			4203.20.00
			4254.30.00
			8900.40.00







Vehicle list

			 RUEN	 Parameter	
---	---	---	--	--	---





































VOLVO

F 88						
F 88 6x2 LHD 6x2, 6x4 RHD				8901.40.00	KZI - 5	- From chassis no.: 33995 - To chassis no.: 46790 - Engine code: TD 100 A - GBox: R61, SR61
				3892.20.00	380 GF2/380	- From chassis no.: 33995 - To chassis no.: 46790 - Engine code: TD 100 A - GBox: R61, SR61
				3871.30.00	380 10 380/70GSZ	- From chassis no.: 33995 - To chassis no.: 46790 - Engine code: TD 100 A - GBox: R61, SR61
				3515.10.00	350 GF2/350	- From chassis no.: 46791 - Engine code: TD 100 A - Equipment Var: 6x2, 6x4 RHD - This part number includes one clutch disc
				3590.30.00	350 10 350GSZ	- From chassis no.: 46791 - Engine code: TD 100 A - Equipment Var: 6x2, 6x4 RHD - Loose clutch disc
				3515.20.00	350 GF2/350	- From chassis no.: 46791 - Engine code: TD 100 A - Equipment Var: 6x2, 6x4 RHD
				3589.30.00	350 10 350GTZ	- From chassis no.: 46791 - Engine code: TD 100 A - Equipment Var: 6x2, 6x4 RHD
				3835.30.00	380 10 380GTZ	- From chassis no.: 33995 - To chassis no.: 46790 - Engine code: TD 100 A - GBox: R61, SR61 - Loose clutch disc
F 88 6x2,6x4 RHD				8901.40.00	KZI - 5	- From chassis no.: 33995 - To chassis no.: 40395 - Engine code: TD 100 A - GBox: R61, SR61 - From chassis no.: 42121 - To chassis no.: 46790
				3892.20.00	380 GF2/380	- From chassis no.: 33995 - To chassis no.: 40395 - Engine code: TD 100 A - GBox: R61, SR61 - From chassis no.: 42121 - To chassis no.: 46790
				3871.30.00	380 10 380/70GSZ	- From chassis no.: 33995 - To chassis no.: 40395 - Engine code: TD 100 A - GBox: R61, SR61 - From chassis no.: 42121 - To chassis no.: 46790
				3835.30.00	380 10 380GTZ	- From chassis no.: 33995 - To chassis no.: 40395 - Engine code: TD 100 A - GBox: R61, SR61 - From chassis no.: 42121 - To chassis no.: 46790 - Loose clutch disc

Vehicle list

					
---	---	---	--	---	---

VOLVO

F 89					
F 89		4200.90.71	420 10	- Engine code: TD 110, 120 A	
		4203.20.00	G420KR		
		4254.30.00	420GSZ		
		8900.40.00	KZI - 5		
		3870.30.00	380 10	- Engine code: TD 120 A	
			380/210GSZ	- Loose clutch disc	
		3892.20.00	380	- Engine code: TD 120 A	
			GF2/380		
	3871.30.00	380 10	- Engine code: TD 120 A		
		380/70GSZ			
	4203.20.00	420	- Engine code: TD 110, 120 A		
		G420KR			
	4254.30.00	420 10	- Engine code: TD 110, 120 A		
		420GSZ			
	8900.40.00	KZI - 5	- Engine code: TD 110, 120 A		
	8901.40.00	KZI - 5	- Engine code: TD 120 A		
FB - Serie					
FB 86		3803.20.00	380	- GBox: R 51	
		7802.40.00	KZA - 4	- GBox: R 51	
FB 86 über 32 t Gesamtgewicht		3500.90.51	350 10		
		3516.10.00	GF2/350		
		3562.30.00	350GSZ		
		5902.40.00	KZA - 4		
		3515.10.00	350		
			GF2/350		
	3562.30.00	350 10	- Loose clutch disc		
		350GSZ			
	3515.20.00	350			
		GF2/350			
	3515.50.00	350			
		GF2-350			
	3530.30.00	350 10	- Contained in xxxx.10.00		
		350GSZ			
FB 88		4200.90.71	420 10	- GBox: R 61, SR 61	
		4203.20.00	G420KR		
		4254.30.00	420GSZ		
		8900.40.00	KZI - 5		
FB 89		4200.90.71	420 10		
		4203.20.00	G420KR		
		4254.30.00	420GSZ		
	8900.40.00	KZI - 5			
	3849.20.00	380			
		G380KR			
	3871.30.00	380 10			
		380/70GSZ			
FB 88 T		4200.90.71	420 10	- Engine code: T 100A, B ;TD 100A	
		4203.20.00	G420KR	- GBox: R 61, SR 61	
		4254.30.00	420GSZ		
		8900.40.00	KZI - 5		



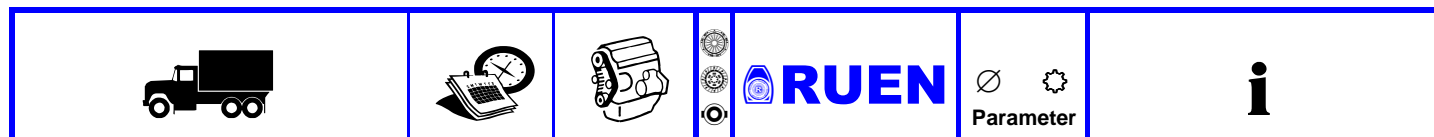



Vehicle list



































VOLVO

FE		05.06 -				
FE 240-18, Dump Truck	05.06 -	D7F300	3950.90.20	10	- GBox: ZTO 1006 / ZTO 1109	
FE 240-18, Utility truck	05.06 -	D7E240	3961.20.00	MF395		
FE 240-18, Platform/Chassis	05.06 -	D7E280	3973.30.00	395WGTZ		
FE 240-18, Truck Tractor	05.06 -	D7F240	8543.40.00	KZIS-4		
FE 240-22, 22t, Platform/Chassis	05.06 -	D7F260	8641.47.00	PHIS-6/38	- GBox: AT 2412 D	
FE 240-26, 6x2	05.06 -	D7F340				
FE 240-26, 6x4	05.06 -					
FE 240-26, 6x2	05.06 -					
FE 240-26, 6x2/4	05.06 -					
FE 240-26, 6x4	05.06 -					
FE 260-18, Utility truck	05.06 -					
FE 260-18, Platform/Chassis	05.06 -					
FE 260-18, Truck Tractor	05.06 -					
FE 260-26, Utility truck, 6x2/4	05.06 -					
FE 260-26, Platform/Chassis, 6x2	05.06 -					
FE 260-26, Platform/Chassis, 6x2/4	05.06 -					
FE 260-26, Platform/Chassis, 6x4	05.06 -					
FE 280-18, Dump Truck	05.06 -					
FE 280-18, Utility truck	05.06 -					
FE 280-18, Platform/Chassis	05.06 -					
FE 280-18, Truck Tractor	05.06 -					
FE 280-22, Platform/Chassis, 6x2	05.06 -					
FE 280-26, Dump Truck, 6x2	05.06 -					
FE 280-26, Dump Truck, 6x4	05.06 -					
FE 280-26, Utility truck, 6x2/4	05.06 -					
FE 280-26, Platform/Chassis, 6x2	05.06 -					
FE 280-26, Platform/Chassis, 6x2/4	05.06 -					
FE 280-26, Platform/Chassis, 6x4	05.06 -					
FE 300-18, Utility truck	05.06 -					
FE 300-18, Platform/Chassis	05.06 -					
FE 300-18, Truck Tractor	05.06 -					
FE 300-26, Utility truck, 6x2/4	05.06 -					
FE 300-26, Platform/Chassis, 6x2	05.06 -					
FE 300-26, Platform/Chassis, 6x2/4	05.06 -					
FE 300-26, Platform/Chassis, 6x4	05.06 -					
FE 340-18, Utility truck	05.06 -					
FE 340-18, Platform/Chassis	05.06 -					
FE 340-18, Truck Tractor	05.06 -					
FE 340-26, Utility truck, 6x2/4	05.06 -					
FE 340-26, Platform/Chassis, 6x2	05.06 -					
FE 340-26, Platform/Chassis, 6x2/4	05.06 -					
FE 340-26, Platform/Chassis, 6x4	05.06 -					
FE 320-18, Dump Truck	05.06 -	D7E320	8641.47.00	PHIS-6/38	- GBox: AT 2412 D	
FE 320-18, Utility truck	05.06 -					
FE 320-18, Platform/Chassis	05.06 -					
FE 320-18, Truck Tractor	05.06 -					
FE 320-22, Platform/Chassis	05.06 -					
FE 320-26, Dump Truck, 6x2	05.06 -					
FE 320-26, Dump Truck, 6x4	05.06 -					
FE 320-26, Utility truck, 6x2/4	05.06 -					
FE 320-26, Platform/Chassis, 6x2	05.06 -					
FE 320-26, Platform/Chassis, 6x2/4	05.06 -					
FE 320-26, Platform/Chassis, 6x4	05.06 -					







Vehicle list

					
---	---	---	--	---	---















VOLVO

FE II		05.12 -				
FE 240-18 FE 240-26	05.12 -	D7B230	 3950.90.20	10	- GBox: ZTO 1006 / ZTO 1109	
	05.12 -	D7E240	 3961.20.00	MF395		
	05.12 -	D7F240	 3973.30.00	395WGTZ		
			 8543.40.00	KZIS-4		
			 4329.30.00	430 24 430WGTZ.	- GBox: AT 2412 F	
			 8641.47.00	PHIS-6/38	- GBox: AT 2412 F	
FE 250-18 FE 250-26 FE 280-18, 7698cc, Platform/Chassis FE 280-18 FE 280-26, 7146cc, Platform/Chassis, 6x2 FE 280-26, 7698cc, Platform/Chassis, 6x2 FE 280-26, 6x4 FE 300-18, Utility truck FE 300-18, Platform/Chassis FE 300-18, Truck Tractor FE 320-18, Platform/Chassis FE 320-18, Truck Tractor FE 320-26, 6x2 FE 320-26, 6x4	05.12 -	D7E280	 3950.90.20	10	- GBox: 6S 1000	
	05.12 -	D7F300	 3961.20.00	MF395	- GBox: ZTO 1006 / 6S 1000	
	05.12 -	D8K250	 3973.30.00	395WGTZ		
	05.12 -	D8K280	 8543.40.00	KZIS-4		
	05.12 -	D8K320	 3950.90.24	395 10	- GBox: 6AS 1000 TO	
	05.12 -		 3961.20.00	MF395		
	05.12 -		 3974.30.00	395WGTZ		
	05.12 -		 8543.40.00	KZIS-4		
	05.12 -					
	05.12 -					
	05.12 -					
	05.12 -					
	05.12 -					
	05.12 -					
FE 260-18, Utility truck FE 260-18, Platform/Chassis FE 260-18, Truck Tractor FE 260-26, Utility truck, 6x2/4 FE 260-26, Platform/Chassis, 6x2 FE 260-26, Platform/Chassis, 6x4 FE 280-18, Utility truck FE 280-18, Platform/Chassis FE 280-26, Utility truck, 6x2/4	05.12 -	D7E280	 3950.90.20	10	- GBox: ZTO 1006 / ZTO 1109	
	05.12 -	D7F260	 3961.20.00	MF395		
	05.12 -		 3973.30.00	395WGTZ		
	05.12 -		 8543.40.00	KZIS-4		
	05.12 -		 4329.30.00	430 24 430WGTZ.	- GBox: AT 2412 F	
	05.12 -		 8641.47.00	PHIS-6/38	- GBox: AT 2412 F	
	05.12 -					
	05.12 -					
FE 300-26, Utility truck, 6x2/4 FE 300-26, Platform/Chassis, 6x2 FE 300-26, Platform/Chassis, 6x4 FE 340-18 FE 340-26	05.12 -	D7F300	 3950.90.20	10	- GBox: ZTO 1006 / ZTO 1109	
	05.12 -	D7F340	 3961.20.00	MF395	- GBox: 6S 1000	
	05.12 -		 3973.30.00	395WGTZ		
	05.12 -		 8543.40.00	KZIS-4		
	05.12 -		 8641.47.00	PHIS-6/38	- GBox: AT 2412 D	
FE 6						
Mot. TD 61	01.85 -		 3800.90.10	380 10	- GBox: S5-65	
			 3860.20.00	GM380K		
			 3886.30.00	380GSZ		
			 5902.40.00	KZA - 4		
FE 7						
Mot. TD 71, 73	01.85 -		 4300.90.22 ⊕	430 10	- GBox: R52B	
			 4332.60.00	MFZ430		
			 4335.30.00	430GTZ		

Vehicle list

					
---	---	---	--	---	---

VOLVO

FH		09.05 -				
400, 4x2	09.05 -	D13A400		4300.90.09	430 24	- Vehicles with double disc clutch
400, 6x2	09.05 -	D13B400		4328.20.00	MFZ430	
400, 6x4	09.05 -	D13A440		4333.30.00	430WGTZ	
440, 4x2	09.05 -	D13A480		8631.47.00	HHISZ-4	
440, 6x2	09.05 -	D13A520				
440, 6x4	09.05 -	D13B440				
480, 4x2	09.05 -	D13H440				
480, 6x2	09.05 -					
480, 6x4	09.05 -					
520, 4x2	09.05 -					
520, 6x2	09.05 -					
520, 6x4	09.05 -					
400, 6x2/4	09.05 -	D13A400		4300.90.106 ⊕	430 24	- Engine code: D13A400, D13B400
400, 8x2/4	09.05 -	D13B400		4382.60.00	MFZ430	- GBox: VT2214B, VT2514B, VTO2214B, VTO2514B
400, 8x4	09.05 -			4389.30.00	430WGTZ	
400, 4x2	09.05 -			4398.30.00	430 24	- Engine code: D13A400, D13B400
400, 6x2	09.05 -				430WGTZ	- GBox: AT2412C, AT2512C,, ATO2512C
400, 6x4	09.05 -			4300.90.118 ⊕	430 24	- Engine code: D13A400, D13B400
				4384.60.00	MFZ430	- GBox: VT2009B
				4389.30.00	430WGTZ	
				4000.90.28	400 24	- Engine code: D13A400, D13B400
				4027.10.00	MFZ2/400X	- Vehicles with double disc clutch
				4032.30.00	400WGTZ	

Vehicle list

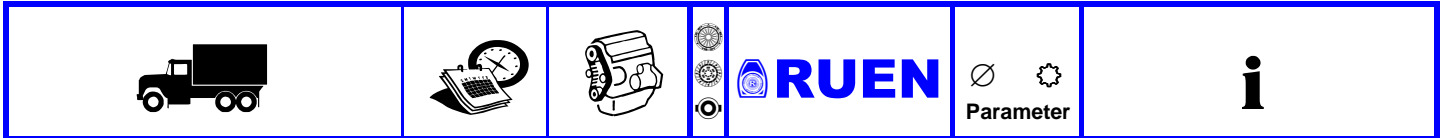

VOLVO

FH		09.05 -				
420, 4x2	01.09 -	D13C420		4300.90.129 ⊕	430 24	- Engine code: D13C
420, 6x2	01.09 -	D13C460		4382.60.00	MFZ430	- GBox: VT 2214B / VTO 2214B, VT 2514B / VTO 2514B
420, 6x2/4	01.09 -	D13C500		4398.30.00	430WGTZ	- GBox: VT 2814B / VTO 2814B
420, 6x4	01.09 -	D13C540		4000.90.29 ⊕	400 24	- GBox: VT 2214B / VTO 2214B, VT 2514B / VTO 2514B
420, 8x2	01.09 -			4047.10.00	MFZ2/400X	- GBox: VT 2814B / VTO 2814B
420, 8x2/4	01.09 -			4032.30.00	400WGTZ	- Vehicles with double disc clutch
420, 8x4/4	01.09 -			8641.47.00	PHIS-6/38	- Engine code: D13C
420, 8x4	01.09 -					- GBox: AT 2412/E /AT 2612/E, ATO 2612/E
420, 4x2	01.09 -					
420, 6x2/4	01.09 -					
420, 6x2	01.09 -					
420, 6x4	01.09 -					
460, 4x2	01.09 -					
460, 6x2	01.09 -					
460, 6x2/4	01.09 -					
460, 6x4	01.09 -					
460, 8x2/4	01.09 -					
460, 8x4	01.09 -					
460, 4x2	01.09 -					
460, 6x2	01.09 -					
460, 6x4	01.09 -					
460	01.09 -					
500, 26.00t, 6x2	01.09 -					
500, 34.00t, 6x4	01.09 -					
500, 42.00t, 8x4	01.09 -					
500, 27.00t, 6x2	01.09 -					
500, 33.10t, 6x4	01.09 -					
540	01.09 -					
	01.09 -					
	01.09 -					
	01.09 -					
	01.09 -					
	01.09 -					
	01.09 -					
	01.09 -					
	01.09 -					
	01.09 -					
	01.09 -					
	01.09 -					

Vehicle list



VOLVO

FH		09.05 -				
440	09.05 -	D13A440		4000.90.28	400 24	- Engine code: D13A440, D13B440
440, 6x2/4	09.05 -	D13A480		4027.10.00	MFZ2/400X	- Engine code: D13A480
440, 8x2/4	09.05 -	D13A520		4032.30.00	400WGTZ	- Engine code: D13A520 - Vehicles with double disc clutch
440, 8x4	09.05 -	D13B440		4300.90.106 ⊕	430 24	- Engine code: D13A440, D13B440
440, 4x2	09.05 -			4382.60.00	MFZ430	- Engine code: D13A480
440, 6x2	09.05 -			4389.30.00	430WGTZ	- Engine code: D13A520 - GBox: VT2214B, VT2514B, VTO2214B - GBox: VTO2514B
440, 6x4	09.05 -					
480, 6x2/4	09.05 -			4398.30.00	430 24	- Engine code: D13A440, D13B440
480, 8x2/4	09.05 -				430WGTZ	- Engine code: D13A480
480, 8x4	09.05 -					- Engine code: D13A520
480, 4x2	09.05 -					- GBox: AT2412C, AT2512C, ATO2512C
480, 6x2	09.05 -			8641.47.00	PHIS-6/38	- Engine code: D13A440, D13B440
480, 6x4	09.05 -					- Engine code: D13A480
520	09.05 -					- Engine code: D13A520
520, 6x2/4	09.05 -					- GBox: AT2412C, AT2512C, ATO2512C
520, 8x2/4	09.05 -					
520, 8x4	09.05 -					
520, 4x2	09.05 -					
520, 6x2	09.05 -					
520, 6x4	09.05 -					
500	09.05 -	D13B500		4000.90.29 ⊕	400 24	- GBox: VT 2214B / VTO 2214B, VT
500, 42.00t, 8x4	09.05 -	D13C500		4047.10.00	MFZ2/400X	2514B / VTO 2514B,
500, 21.00t, 4x2	09.07 -			4032.30.00	400WGTZ	- GBox: VT 2814B / VTO 2814B
500, 27.00t, 6x2/4	09.07 -					- Vehicles with double disc clutch
500, 35.00t, 8x2/4	09.07 -					

Vehicle list



VOLVO

FH II		01.12 -					
420, 18.60t, 4x2	01.12 -	D12C420	⊙	8641.47.00	PHIS-6/38	- GBox: AT 2412/E, AT 2612/E, ATO 2612/E	
420, 27t, 6x2	01.12 -	D13C420	⊙	4300.90.129 ⊕	430 24	- GBox: VT 2214B / VTO 2214B, VT 2514B / VTO 2514B	
420, 28.50t, 6x4	01.12 -	D13C460				MFZ430	- GBox: VT 2814B / VTO 2814B
420, 20.10, 21t, 4x2	05.12 -	D13C500				430WGTZ	
420, 26.10, 27t, 6x2/4	05.12 -	D13C540	⊙	4000.90.29 ⊕	400 24	- GBox: VT 2214B / VTO 2214B, VT 2514B / VTO 2514B	
420, 29, 34t, 6x4	05.12 -	D13K420				MFZ2/400X	- GBox: VT 2814B / VTO 2814B
420, 35t, 8x2/4	05.12 -	D13K460				400WGTZ	- Vehicles with double disc clutch
420, 35, 37, 42t, 8x4/4	05.12 -	D13K500					
420, 20.10t, 4x2	05.12 -	D13K540					
420, 26.10, 26.50t, 6x2/4	05.12 -						
420, 33.50t, 6x4	05.12 -						
420, 35t, 8x2/4	05.12 -						
460, 18.60t, 4x2	01.12 -						
460, 27t, 6x2	01.12 -						
460, 28.50t, 6x4	01.12 -						
460, 20.10, 21t, 4x2	05.12 -						
460, 26.10, 27t, 6x2/4	05.12 -						
460, 29, 34t, 6x4	05.12 -						
460, 35t, 8x2/4	05.12 -						
460, 35, 37, 42t, 8x4/4	05.12 -						
460, 20.10t, 4x2	05.12 -						
460, 26.10, 26.50t, 6x2/4	05.12 -						
460, 33.50t, 6x4	05.12 -						
460, 35t, 8x4/4	05.12 -						
500, 35t, 8x4	01.12 -						
500, 18.60t, 4x2	01.12 -						
500, 27t, 6x2	01.12 -						
500, 28.50t, 6x4	01.12 -						
500, 35t, 8x4	01.12 -						
500, 20.10, 21t, 4x2	05.12 -						
500, 26.10, 27t, 6x2/4	05.12 -						
500, 29, 34t, 6x4	05.12 -						
500, 35t, 8x2/4	05.12 -						
500, 35, 37, 42t, 8x4/4	05.12 -						
500, 20.10t, 4x2	05.12 -						
500, 26.10, 26.50t, 6x2/4	05.12 -						
500, 33.50t, 6x4	05.12 -						
500, 35t, 8x4/4	05.12 -						
500, 42t, Platform/Chassis	09.12 -						
500, 42t, Truck Tractor	09.12 -						
540, 18.60t, 4x2	01.12 -						
540, 27t, 6x2	01.12 -						
540, 28.50t, 6x4	01.12 -						
540, 20.10, 21t, 4x2	05.12 -						
540, 26.10, 27t, 6x2/4	05.12 -						
540, 29, 34t, 6x4	05.12 -						
540, 35t, 8x2/4	05.12 -						
540, 35, 37, 42t, 8x4/4	05.12 -						
540, 20.10t, 4x2	05.12 -						
540, 26.10, 26.50t, 6x2/4	05.12 -						
540, 33.50t, 6x4	05.12 -						
540, 35t	05.12 -						

Vehicle list

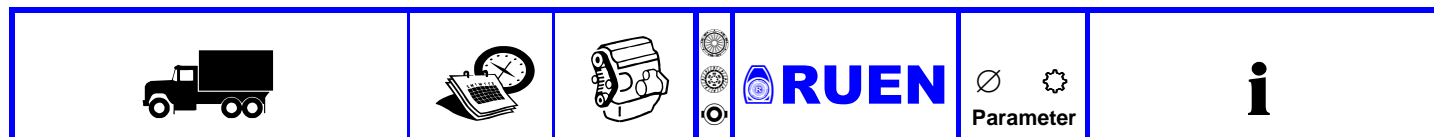

VOLVO

FH II 01.12 -

420, 29t, 6x4	05.12 -	D13C420	8641.47.00	PHIS-6/38	- GBox: AT 24112F / AT 2612F, ATO 2612F
420, 35t, 8x2	05.12 -	D13C500	4300.90.129 ⊕	430 24	- GBox: VT2214B / VTO 2214B, VT2514B / VTO 2514B
420, 35t, 8x4	05.12 -	D13K420	4382.60.00	MFZ430	
420, 37t, 8x4/4	05.12 -	D13K460	4398.30.00	430WGTZ	
420, 35t, 8x4	05.12 -	D13K500			
420, 43t	05.12 -	D13K540			
420, 35t, 8x4/4	05.12 -				
460, 29t, 6x4	05.12 -				
460, 35t, 8x2	05.12 -				
460, 35t, 8x4	05.12 -				
460, 37t, 8x4/4	05.12 -				
460, 27t, 6x2	05.12 -				
460, 35t, 8x4	05.12 -				
460, 43t	05.12 -				
500, 29t, 6x4	05.12 -				
500, 35t, 8x2	05.12 -				
500, 35t, 8x4	05.12 -				
500, 37t, 8x4/4	05.12 -				
500, 27t, 6x2	05.12 -				
500, 43t	05.12 -				
540, 29t, 6x4	05.12 -				
540, 35t, 8x2	05.12 -				
540, 35t, 8x4	05.12 -				
540, 37t, 8x4/4	05.12 -				
540, 27t, 6x2	05.12 -				
540, 43t	05.12 -				

FH 12 08.93 -

Mot. D 12 A	01.93 -		4300.90.33 ⊕	430 10	- GBox: R/SR1700, 1900
			4332.60.00	MFZ430	
			4331.30.00	430WGTZ	
			4331.30.00	430 10	- GBox: R/SR1700, 1900
			4304.26.00 ⊖	430	- GBox: R/SR1700, 1900
				MFZ430	
FH 12/340, Dump Truck, 6x4	08.93 -	D12A340	4300.90.34 ⊕	430 10	- GBox: VT2014,VT2014OD
FH 12/340, Platform/Chassis, 4x2	08.93 -	D12C340	4333.60.00	MFZ430	
FH 12/340, 25.00t, Platform/Chassis, 6x2	01.95 -	D12D340	4331.30.00	430WGTZ	
FH 12/340, 26.00t, Platform/Chassis, 6x2	08.93 -		4300.90.33 ⊕	430 10	- GBox: R/SR1700/1900
FH 12/340, Platform/Chassis, 6x4	08.93 -		4332.60.00	MFZ430	
FH 12/340, Platform/Chassis, 8x2/4	08.93 -		4331.30.00	430WGTZ	
FH 12/340, Platform/Chassis, 8x4/4	08.93 -		4047.10.00	400	- GBox: VT2214B, VTO2214B
FH 12/340, Truck Tractor, 6x2/2/4	08.93 -			MFZ2/400X	- Engine code: D12D380
			8925.40.00	KZISZ-5	- This part number includes one clutch disc
			8946.46.00	KZIZ-5	

Vehicle list

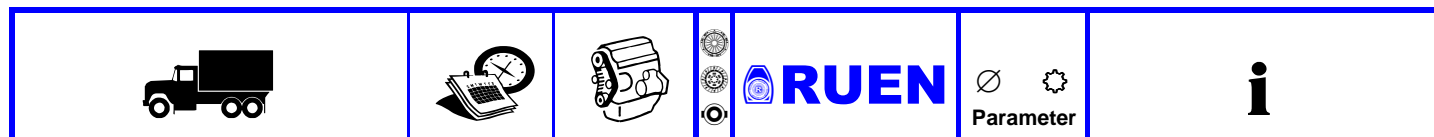

VOLVO

FH 12 08.93 -

FH 12/380, Platform/Chassis, 8x2/4	08.93 -	D12A380		4000.90.09 ⊕	400 24	
FH 12/380, Platform/Chassis, 8x4/4	08.93 -	D12C380		4027.60.00	MFZ2/400X	
FH 12/380, Platform/Chassis, 4x2	08.93 -	D12D380		4032.30.00	400WGTZ	
FH 12/380, 4x2	08.93 -			4000.90.08 ⊕	400 24	- GBox: VT2214B, VT02214B
FH 12/380, Platform/Chassis, 6x2	01.95 -			4027.10.00	MFZ2/400X	
FH 12/380, Platform/Chassis, 6x4	08.93 -			4032.30.00	400WGTZ	
FH 12/380, Dump Truck, 6x4	08.93 -			4300.90.62 ⊕	430 24	- GBox: VT2412B
FH 12/380, Truck Tractor, 6x2/2/4	08.93 -			4336.60.00	MFZ430	
FH 12/380, Truck Tractor, 6x4	08.93 -			4329.30.00	430WGTZ.	
				4300.90.34 ⊕	430 10	- GBox: VT2014,VT2012OD
				4333.60.00	MFZ430	
				4331.30.00	430WGTZ	
				4300.90.33 ⊕	430 10	- GBox: R/SR1700/1900
				4332.60.00	MFZ430	
				4331.30.00	430WGTZ	
				4300.90.35 ⊕	430 24	- GBox: VT2214B,VT02214B
				4333.60.00	MFZ430	
				4325.30.00	430WGTZ	
				4300.90.16 ⊕	430 24	- GBox: VT2009B
				4332.60.00	MFZ430	
				4325.30.00	430WGTZ	
				4047.10.00	400	- GBox: VT2214B, VTO2214B
					MFZ2/400X	- Engine code: D12D380
						- This part number includes one clutch disc
				8946.46.00	KZIZ-5	
				8925.40.00	KZISZ-5	
FH 12/420, Platform/Chassis, 4x2	08.93 -	D12A420		4000.90.09 ⊕	400 24	- GBox: VT2214B, VTO2214B
FH 12/420, 6x2	01.95 -	D12C420		4027.60.00	MFZ2/400X	
FH 12/420, Platform/Chassis, 6x2	08.93 -	D12D420		4032.30.00	400WGTZ	
FH 12/420, Platform/Chassis, 6x4	08.93 -			4300.90.62 ⊕	430 24	- GBox: VT2412B
FH 12/420, Dump Truck, 6x4	08.93 -			4336.60.00	MFZ430	
FH 12/420, Truck Tractor, 6x2/2/4	08.93 -			4329.30.00	430WGTZ.	
FH 12/420, Truck Tractor, 6x4	08.93 -			4000.90.08 ⊕	400 24	- GBox: VT2214B, VTO2214B
FH 12/420, Platform/Chassis, 8x2/4	08.93 -			4027.10.00	MFZ2/400X	
FH 12/420, Platform/Chassis, 8x4/4	08.93 -			4032.30.00	400WGTZ	
				4300.90.34 ⊕	430 10	- GBox: VT2014, VT2014OD
				4333.60.00	MFZ430	
				4331.30.00	430WGTZ	
				4300.90.33 ⊕	430 10	- GBox: R/SR1700/1900
				4332.60.00	MFZ430	
				4331.30.00	430WGTZ	
				4300.90.35 ⊕	430 24	- GBox: VT2214B, VTO2214B
				4333.60.00	MFZ430	
				4325.30.00	430WGTZ	
				4300.90.16 ⊕	430 24	- GBox: VT2009B
				4332.60.00	MFZ430	
				4325.30.00	430WGTZ	
				4047.10.00	400	- Engine code: D12D380
					MFZ2/400X	- GBox: VT2214B, VTO2214B
						- This part number includes one clutch disc
				8925.40.00	KZISZ-5	
				8946.46.00	KZIZ-5	

Vehicle list

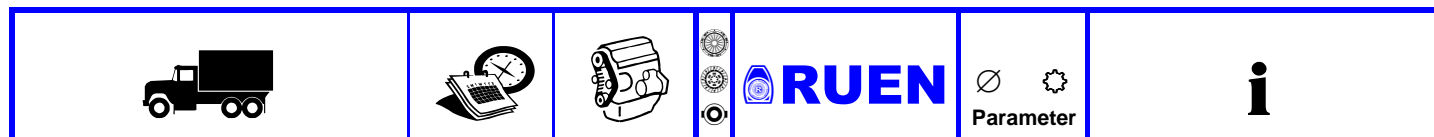

VOLVO

FH 12 08.93 -

FH 12/460, Platform/Chassis, 4x2 FH 12/460, 6x2 FH 12/460, Platform/Chassis, 6x2 FH 12/460, Platform/Chassis, 6x4 FH 12/460, Truck Tractor, 6x4 FH 12/460, Truck Tractor, 6x2/2/4 FH 12/460, Dump Truck, 6x4 FH 12/460, Platform/Chassis, 8x2/4 FH 12/460, Platform/Chassis, 8x4/4	08.98 -	D12C460		4000.90.09 ⊕ 4027.60.00 4032.30.00	400 24 MFZ2/400X 400WGTZ		
	08.98 -	D12D460		4000.90.08 ⊕ 4027.10.00 4032.30.00	400 24 MFZ2/400X 400WGTZ	- GBox: VT2514B, VTO2514B	
	08.98 -			4000.90.10 ⊕ 4027.10.00 4033.30.00	400 10 MFZ2/400X 400WGTZ	- GBox: VT2412B	
	08.98 -			4300.90.64 ⊕ 4383.60.00 4389.30.00	430 24 MFZ430 430WGTZ	- GBox: VT2514B	
	08.98 -			4300.90.23 ⊕ 4383.60.00 4380.30.00	430 10 MFZ430 430WGTZ	- GBox: VT2514	
	08.98 -			4300.90.34 ⊕ 4333.60.00 4331.30.00	430 10 MFZ430 430WGTZ	- GBox: VT2014, VT2014OD	
	08.98 -			4047.10.00	400 MFZ2/400X	- GBox: VT2214B, VTO2214B - Engine code: D12D380 - This part number includes one clutch disc	
	08.98 -			4300.90.128 4383.60.00 4389.30.00	430 24 MFZ430 430WGTZ	- Transmission type: VT2514B - Engine code: D12D460	
	FH 12/500	09.01 -	D12D500		4000.90.09 ⊕ 4027.60.00 4032.30.00	400 24 MFZ2/400X 400WGTZ	- GBox: VT2514B, VTO2514B
					4000.90.08 ⊕ 4027.10.00 4032.30.00	400 24 MFZ2/400X 400WGTZ	- GBox: VT2514B, VTO2514B
				4300.90.63 ⊕ 4385.60.00 4389.30.00	430 24 MFZ430 430WGTZ	- GBox: VT2412B	
				4047.10.00	400 MFZ2/400X	- Engine code: D12D380 - GBox: VT2214B, VTO2214B - This part number includes one clutch disc	

Vehicle list

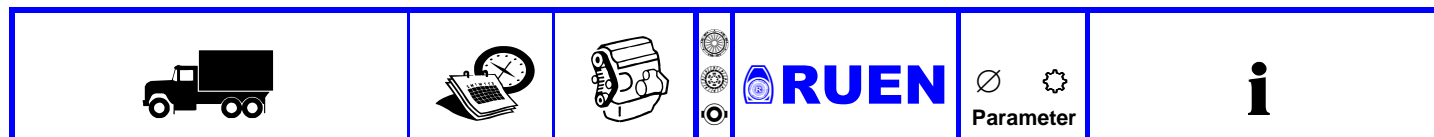

VOLVO

FH 16		08.93 -				
FH 16/470, 18.00t, 4x2	08.93 - 12.99	D16A470		4000.90.10 ⊕	400 10	- Engine code: D16A470,D16B470
FH 16/470, 26.00t, 6x2	08.93 - 12.99	D16A520		4027.10.00	MFZ2/400X	- From chassis no.: A291152, B21585, D120647
FH 16/470, 26.00t, 6x4	08.93 - 12.99	D16B520		4033.30.00	400WGTZ	
FH 16/470, 18.00t, 4x2	08.93 - 12.99			4000.90.15 ⊕	400 10	- Engine code: D16A470,D16B470
FH 16/470, 25.00t, 6x2	08.93 - 12.99			4027.60.00	MFZ2/400X	- From chassis no.: A291152, B21585, D120647
FH 16/470 4x2, 18.00t, Platform/Chassis, 4x2	08.93 -			4033.30.00	400WGTZ	
FH 16/470 4x2, 18.00t, Truck Tractor, 4x2	08.93 -					
FH 16/470 6x2, 26.00t, 6x2	08.93 -					
FH 16/470 6x2, 25.00t, 6x2	01.95 -					
FH 16/470 6x2/2/4, 26.00t, Truck Tractor, 6x2/2/4	08.93 -					
FH 16/470 6x4, 26.00t, Platform/Chassis, 6x4	08.93 -					
FH 16/470 6x4, Truck Tractor, 6x4	08.93 -					
FH 16/520, 18.00t, 4x2	08.93 - 12.02					
FH 16/520, 26.00t, 6x2	08.93 - 12.02					
FH 16/520, 26.00t, 6x4	08.93 - 12.02					
FH 16/520, 18.00t, 4x2	08.93 - 12.02					
FH 16/520, 26.00t, 6x2	08.93 - 12.02					
FH 16/520, 26.00t, 6x4	08.93 - 12.02					
FH 16/520, 26.10t, 6x2/4	08.93 - 12.02					
FH 16/520, 25.00t, 6x2	01.95 -					



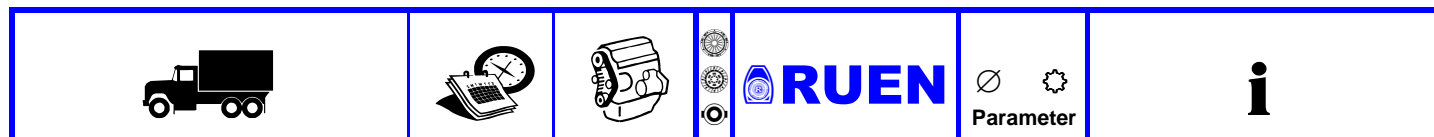



Vehicle list









VOLVO

FH 16		08.93 -			
FH 16/540, 26.10t, 6x2/4	01.09 -	D16E580	4000.90.28 4027.10.00 4032.30.00	400 24 MFZ2/400X 400WGTZ	- Engine code: D16E540, D16C550 - GBox: VT2814B, VTO2814B - Equipment Var: Abgas Japannorm 2004
FH 16/540, 35.00t, 8x2/4	01.09 -	D16C550			
FH 16/540, 35.00t, 8x2/6	01.09 -	D16C610			
FH 16/540, 37.00t, 8x4/4	01.09 -	D16E540	4000.90.08 ⊕ 4027.10.00 4032.30.00	400 24 MFZ2/400X 400WGTZ	- Engine code: D16E540, D16C550 - Engine code: D16C610 - GBox: VT2814B, VTO2814B
FH 16/540, 27.00t, Truck Tractor, 6x2	01.09 -	D16G540			
FH 16/540, FH 16/550, 21.00t, 4x2	01.03 -		4047.10.00	400 MFZ2/400X	- Engine code: D16E540, D16C550 - GBox: VT2814B, VTO2814B - This part number includes one clutch disc
FH 16/540, FH 16/550, 27.00t, 6x2	01.03 -				
FH 16/540, FH 16/550, 29.10t, 6x4	01.03 -				
FH 16/540, FH 16/550, 35.00t, 8x2	01.03 -				
FH 16/540, FH 16/550, 37.00t, 8x4	01.03 -				
FH 16/540, FH 16/550, 20.10t, 4x2	01.03 -				
FH 16/540, FH 16/550, 26.00t, 6x2	01.03 -				
FH 16/540, FH 16/550, 28.00t, 6x4	01.03 -				
FH 16/540, FH 16/550, 34.00t, 6x4	08.07 -				
FH 16/550, 35.00t, 8x4	01.03 -				
FH 16/550, 35.00t, Platform/Chassis, 6x2	05.05 -				
FH 16/550, 35.00t, Truck Tractor, 6x2	09.06 -				
FH 16/580, 21.00t, 4x2	09.06 -				
FH 16/580, 27.00t, 6x2	09.06 -				
FH 16/580, 28.00t, 6x4	09.06 -				
FH 16/580, 35.00t, 8x2	09.06 -				
FH 16/580, 37.00t, 8x4	09.06 -				
FH 16/580, 18.00t, 4x2	09.06 -				
FH 16/580, 27.00t, 6x2	09.06 -				
FH 16/580, 28.00t, 6x4	09.06 -				
FH 16/580, 26.10t, 6x2/4	01.09 -				
FH 16/580, 35.00t, 8x2/4	01.09 -				
FH 16/580, 35.00t, 8x2/6	01.09 -				
FH 16/610, 26.00t, 6x4	09.05 -				
FH 16/610, 21.00t, 4x2	01.03 -				
FH 16/610, 27.00t, 6x2	01.03 -				
FH 16/610, 29.00t, 6x4	01.03 -				
FH 16/610, 35.00t, 8x2	01.03 -				
FH 16/610, 37.00t, 8x4	01.03 -				
FH 16/610, 18.00t, 4x2	01.03 -				
FH 16/610, 26, 28t, 6x2/4	01.03 -				
FH 16/610, 34.00t, 6x4	08.07 -				
FH 16/540, FH 16/550, 26.00t, 6x2/4	01.03 -	D16G600	8641.47.00	PHIS-6/38	- Engine code: D16G - GBox: AT2812/D / ATO3112/D
FH 16/550, 26.00t, 6x4	09.05 -	D16C550			
FH 16/600, 21.00t, 4x2	09.06 -	D16E540			
FH 16/600, 26.00t, 6x2	01.09 -	D16G540			
FH 16/600, 26.10t, 6x2/4	01.09 -				
FH 16/600, 29.10t, 6x4	01.09 -				
FH 16/600, 18.60t, 4x2	01.09 -				
FH 16/600, 26.10t, 6x2/4	01.09 -				
FH 16/700, 21.00t, 4x2	01.09 -	D16G700	8641.47.00	PHIS-6/38	- Engine code: D16G - GBox: ATO 3112/D
FH 16/700, 26.00t, 6x2	01.09 -				
FH 16/700, 26.10t, 6x2/4	01.09 -				
FH 16/700, 34.00t, 6x4	01.09 -				
FH 16/700, 20.10t, 4x2	01.09 -				
FH 16/700, 26.10t, 6x2/4	01.09 -				
FH 16/700, 34.00t, 6x4	01.09 -				
FH 16/700, 41.00t, 8x4/4	01.09 -				

Vehicle list

				 Parameter	
---	---	---	--	--	---

VOLVO

FH 16		08.93 -				
FH 16/610, 18.00t, 4x2	01.03 -	D16C610	 4000.90.28	400 24	- Engine code: D16C610 - GBox: VT2814B, VTO2814B - Equipment Var: Abgas Japannorm 2004	
			 4027.10.00	MFZ2/400X		
			 4032.30.00	400WGTZ		
			 4000.90.08 ⊕	400 24	- Engine code: D16C610 - GBox: VT2814B, VTO2814B	
			 4027.10.00	MFZ2/400X		
			 4032.30.00	400WGTZ		

Vehicle list

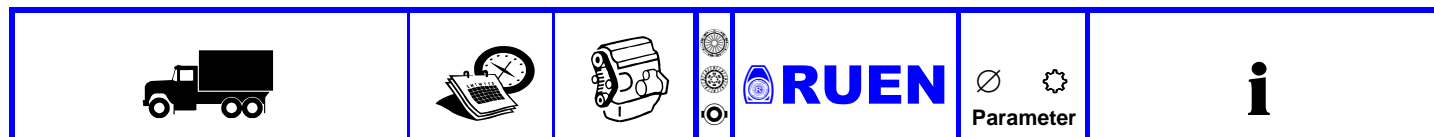

VOLVO

FH 16 II 04.09 -

FH 16/540, FH 16/550, 21t, 4x2	05.12 -	D16G600	8641.47.00	PHIS-6/38	- Engine code: D16G - GBox: AT2812/D / ATO3112/D
FH 16/540, FH 16/550, 27t, 6x2/4	05.12 -	D16G750			
FH 16/540, FH 16/550, 29, 34t, 6x4	05.12 -	D16G540			
FH 16/540, FH 16/550, 35t, 8x2/4	05.12 -	D16G700			
FH 16/540, FH 16/550, 35, 37, 42t, 8x4/4	05.12 -	D16K550			
FH 16/540, FH 16/550, 19, 20.50t, 4x2	05.12 -	D16K650			
FH 16/540, FH 16/550, 26.50t, 6x2/4	05.12 -	D16K750			
FH 16/540, FH 16/550, 28.50, 33.50t, 6x4	05.12 -				
FH 16/540, FH 16/550, 35t, 8x4/4	05.12 -				
FH 16/550, 29t, 6x4	03.14 -				
FH 16/550, 35, 37t, 8x4/4	03.14 -				
FH 16/550, 43t	03.14 -				
FH 16/550, 26.50, 27t, 6x2	03.14 -				
FH 16/600, 21t, 4x2	05.12 -				
FH 16/600, 27t, 6x2/4	05.12 -				
FH 16/600, 29, 34t, 6x4	05.12 -				
FH 16/600, 35t, 8x4/4	05.12 -				
FH 16/600, 19, 20.50t, 4x2	05.12 -				
FH 16/600, 26.50t, 6x2/4	05.12 -				
FH 16/600, 28.50, 33.50t, 6x4	05.12 -				
FH 16/600, 35t, 8x4/4	05.12 -				
FH 16/650, 29t, 6x4	03.14 -				
FH 16/650, 35, 37t, 8x4/4	03.14 -				
FH 16/650, 21t, 4x2	03.14 -				
FH 16/650, 27t, 6x2	03.14 -				
FH 16/650, 29, 34t, 6x4	03.14 -				
FH 16/650, 35t, 8x2/4	03.14 -				
FH 16/650, 35, 37, 42t, 8x4/4	03.14 -				
FH 16/650, 43t	03.14 -				
FH 16/650, 19, 20.50, 21t, 4x2	03.14 -				
FH 16/650, 26.50t, 6x2	03.14 -				
FH 16/650, 26.50t, 6x2/4	03.14 -				
FH 16/650, 29, 33.50t, 6x4	03.14 -				
FH 16/650, 35t, 8x2/4	03.14 -				
FH 16/650, 35t, 8x4/4	03.14 -				
FH 16/700, 21t, 4x2	05.12 -				
FH 16/700, 27t, 6x2/4	05.12 -				
FH 16/700, 29, 34t, 6x4	05.12 -				
FH 16/700, 35t, 8x4/4	05.12 -				
FH 16/700, 19, 20.50t, 4x2	05.12 -				
FH 16/700, 26.50t, 6x2/4	05.12 -				
FH 16/700, 28.50, 33.50t, 6x4	05.12 -				
FH 16/700, 35t, 8x4/4	05.12 -				
FH 16/750, 35t, 8x2/4	03.14 -				
FH 16/750, 42t, 8x4/4	03.14 -				
FH 16/750, 43t	03.14 -				
FH 16/750, 29t, 6x4	03.14 -				
FH 16/750, 35, 37t, 8x4/4	03.14 -				
FH 16/750, 37t, 8x4/4	03.14 -				

Vehicle list



VOLVO

FH 16 II 04.09 -

FH 16/750, 21t, 4x2	05.12 -	D16G750	8641.47.00	PHIS-6/38	- Engine code: D16G - GBox: ATO 3112/D
FH 16/750, 27t, 6x2	05.12 -	D16K750			
FH 16/750, 27t, 6x2/4	05.12 -				
FH 16/750, 29, 34t, 6x4	05.12 -				
FH 16/750, 35t, 8x4/4	05.12 -				
FH 16/750, 19, 20.50t, 4x2	05.12 -				
FH 16/750, 26.50t, 6x2/4	05.12 -				
FH 16/750, 27t, 6x2	05.12 -				
FH 16/750, 28.50, 33.50t, 6x4	05.12 -				
FH 16/750, 35t, 8x4/4	05.12 -				

FH 565 / NH 565 08.93 -

FH 565 / NH 565			4000.90.10 ⊕	400 10 MFZ2/400X 400WGTZ	
			4027.10.00 4033.30.00		
			4000.90.15 ⊕	400 10 MFZ2/400X 400WGTZ	
			4027.60.00 4033.30.00		

FL 03.00 -

FL 180-10	03.00 -	D6B	3886.30.00	380 10 380GSZ	- From chassis no.: 1921636 - To chassis no.: 1921928 - From chassis no.: 2921849 - To chassis no.: 2929187 - From chassis no.: B265000, S921941
FL 180-11	03.00 -				
FL 180-12	03.00 -				
FL 180-13	03.00 -				
FL 180-14	03.00 -				
FL 180-15	03.00 -				
FL 180-16	03.00 -				
FL 180-17	03.00 -				
FL 180-18	03.00 -				
FL 180-7,5	03.00 -				
FL 180-8	03.00 -				
FL 180-9	03.00 -				
FL 220-10	03.00 -				
FL 220-11	03.00 -				
FL 220-12	03.00 -				
FL 220-13	03.00 -				
FL 220-14	03.00 -				
FL 220-15	03.00 -				
FL 220-16	03.00 -				
FL 220-17	03.00 -				
FL 220-18	03.00 -				
FL 220-7,5	03.00 -				
FL 220-8	03.00 -				
FL 220-9	03.00 -				
FL 250-10	03.00 -				
FL 250-11	03.00 -				
FL 250-12	03.00 -				
FL 250-13	03.00 -				
FL 250-14	03.00 -				
FL 250-15	03.00 -				
FL 250-16	03.00 -				
FL 250-17	03.00 -				
FL 250-18	03.00 -				
FL 250-7,5	03.00 -				
FL 250-8	03.00 -				
FL 250-9	03.00 -				

Vehicle list

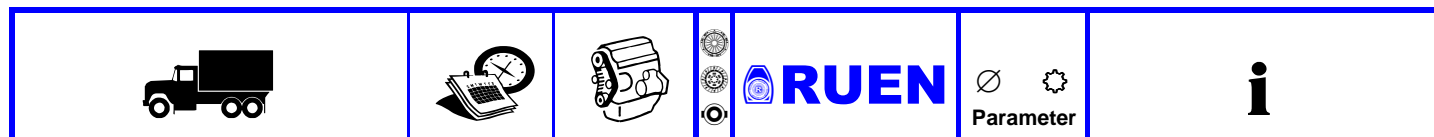

VOLVO

FL 6		09.85 - 03.00				
FL 180	06.00 -	D6B180		3886.30.00	380 10 380GSZ	- From chassis no.: 1921636 - To chassis no.: 1921928 - From chassis no.: 2921849 - To chassis no.: 2929187 - From chassis no.: B265000 - From chassis no.: S921941
FL 205G	06.00 -	D6B220				
FL 220	06.00 -	D6B250				
FL 250	06.00 -	G6B205				
FL 614, 131/132kW, Platform/Chassis	09.85 - 03.00	D6A180		3800.90.10	380 10 GM380K	- To chassis no.: 495167
FL 614, 131/132kW, Truck Tractor	09.85 - 03.00	D6A210		3860.20.00	380GSZ	
FL 614, 132kW, Dump Truck	12.95 - 03.00	D6A230		3886.30.00	KZA - 4	
FL 614, 150kW	09.85 - 03.00	TD 61 F		5902.40.00		
FL 614, 154kW, Dump Truck	12.95 - 03.00	TD 61 GB		3860.20.00	380 GM380K	- To chassis no.: B166079
FL 614, 154kW, Platform/Chassis	12.95 - 03.00	TD 61 GC				
FL 614, 154kW, Truck Tractor	12.95 - 03.00	TD 61 GS		3886.30.00	380 10 380GSZ	- To chassis no.: 1920500 - From chassis no.: B166080 - To chassis no.: B264999 - From chassis no.: 1920501 - To chassis no.: 1920635
		TD 63 E				
		TD 63 ES		5902.40.00	KZA - 4	- From chassis no.: B166080 - To chassis no.: B264999 - From chassis no.: 1920501 - To chassis no.: 1920635
FL 614, 169kW, Dump Truck	12.95 - 03.00	D6A210		3886.30.00	380 10 380GSZ	
FL 614, 169kW, Truck Tractor	12.95 - 03.00	D6A230				
FL 614, 184kW, Platform/Chassis	12.95 - 03.00	D6A250				
FL 614, 150/154kW	09.85 - 03.00	TD 61 F				
FL 614, 169kW	12.95 - 03.00	TD 63 ES				
FL 614, 184kW, Dump Truck	12.95 - 03.00	D6A180		5902.40.00	KZA - 4	
FL 614, 184kW, Truck Tractor	12.95 - 03.00	D6A210				
FL 615, 132kW, Platform/Chassis	11.91 - 03.00	D6A230				
FL 615, 132kW, Dump Truck	11.91 - 03.00	D6A250				
FL 615, 154kW, Platform/Chassis	11.91 - 03.00	TD 63 E				
FL 615, 154kW, Dump Truck	11.91 - 03.00	TD 63 ES				
FL 615, 169kW, Platform/Chassis	12.95 - 03.00					
FL 615, 169kW, Dump Truck	12.95 - 03.00					
FL 615, 184kW, Platform/Chassis	12.95 - 03.00					
FL 615, 184kW, Dump Truck	12.95 - 03.00					
FL 616	11.96 - 05.00	D6A180		5902.40.00	KZA - 4	- To chassis no.: 495167 - To chassis no.: B166079 - To chassis no.: 1920500 - GBox: R1100, S6-65 - GBox: T700, ST700 - From chassis no.: B166080 - To chassis no.: B264999 - From chassis no.: 1920501 - To chassis no.: 1920635
FL 617	11.96 - 05.00	D6A210				
FL 618, 132kW, Platform/Chassis	11.91 - 03.00	D6A230				
FL 618, 132kW, Dump Truck	11.91 - 03.00	D6A250				
FL 618, 154kW, Platform/Chassis	11.91 - 03.00	TD 61 F				
FL 618, 154kW, Dump Truck	11.91 - 03.00	TD 63 E				
FL 618, 169kW, Platform/Chassis	12.95 - 03.00	TD 63 ES				
FL 618, 169kW, Dump Truck	12.95 - 03.00			7802.40.00	KZA - 4	- To chassis no.: 495167 - To chassis no.: B166079 - To chassis no.: 1920500 - GBox: R52B
FL 618, 184kW, Platform/Chassis	12.95 - 03.00					
FL 618, 184kW, Dump Truck	12.95 - 03.00					
FL 619	09.85 - 11.94					
FL 626	11.96 - 05.00			3800.90.10	380 10 GM380K	- To chassis no.: 495167 - To chassis no.: 434812
				3860.20.00	380GSZ	
				3886.30.00	KZA - 4	
				5902.40.00		
				3800.90.48	380 10 GM380K	- To chassis no.: 495167 - To chassis no.: 434812
				3860.20.00	380GSZ	
				3886.30.00	KZA - 4	
				7802.40.00		
				3886.30.00	380 10 380GSZ	- To chassis no.: 495167 - To chassis no.: B166079 - To chassis no.: 1920500

Vehicle list

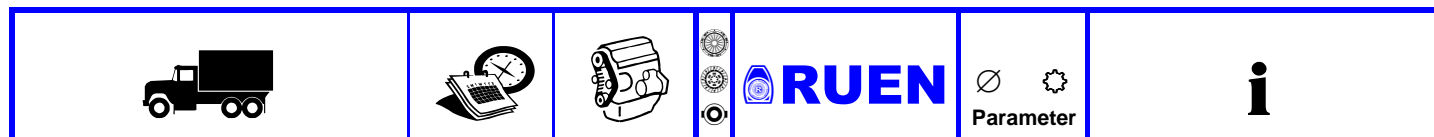

VOLVO







FL 7 09.85 - 09.98

Mot. TD 71, 73 Volvo KFD117A,B, Volvo KFD214A, Volvo KFD117A	01.85 -		4300.90.76 ⊕ 4332.60.00 4336.30.00	430 10 MFZ430 430GTZ	- To chassis no.: 900816
			4300.90.22 ⊕ 4332.60.00 4335.30.00	430 10 MFZ430 430GTZ	- GBox: R52B
Mot. TD 71, 73 Volvo KFD116A		D7A285	4055.30.00	400 10 400GVZ	- From chassis no.: 358958 - GBox: R1000,R/SR,1400,1700
FL 7/230, 4x2	09.85 - 09.98	D7B230			
FL 7/230, 6x2	09.85 - 09.98	D7B260			
FL 7/230, 4x2	09.85 - 09.98	TD 71 F			
FL 7/230, 6x2	09.85 - 09.98	TD 71 FQ			
FL 7/230, Platform/Chassis, 6x2/4	09.85 - 09.98	TD 73 E			
FL 7/230, Truck Tractor, 4x2	09.85 - 09.98	TD 73 ES			
FL 7/260, 4x2	11.91 - 09.98				
FL 7/260, 6x2	11.91 - 09.98				
FL 7/260, 4x2	11.91 - 09.98				
FL 7/260, 6x2	11.91 - 09.98				
FL 7/260, 6x2/4	11.91 - 09.98				
FL 7/260, Truck Tractor, 4x2	11.91 - 09.98				
FL 7/290, 4x2	10.93 - 09.98				
FL 7/290, 6x2	10.93 - 09.98				
FL 7/290, 6x4	10.93 - 09.98				
FL 7/290, 4x2	10.93 - 09.98				
FL 7/290, 6x2	10.93 - 09.98				
FL 7/290, 6x2/4	10.93 - 09.98				
FL 7/290, Truck Tractor, 4x2	10.93 - 09.98				

FL 10 09.85 - 09.98





















Mot. TD 101, 102, 103	01.85 -		4300.90.21 ⊕ 4332.60.00 4323.30.00	430 10 MFZ430 430WGTZ	- GBox: R/SR1400,1700
FL 10/260	01.85 - 12.89	D10A320	4300.90.76 ⊕ 4332.60.00 4336.30.00	430 10 MFZ430 430GTZ	- GBox: R/SR1400,1700
FL 10/280, Dump Truck, 4x2	09.85 - 12.90	TD 101 F			
FL 10/280, Platform/Chassis, 4x2	09.85 - 12.90	TD 101 G			
FL 10/280, Truck Tractor, 4x2	09.85 - 12.90	TD 102 F			
FL 10/280, Platform/Chassis, 6x2	09.85 - 12.90	TD 103 E			
FL 10/285	01.90 - 12.95				
FL 10/290	01.88 - 12.89				
FL 10/320	01.90 - 12.95				
FL 10/320, Dump Truck, 4x2	12.95 - 09.98				
FL 10/320, Platform/Chassis, 4x2	12.95 - 09.98				
FL 10/320, Platform/Chassis, 6x2/2/4	12.95 - 09.98				
FL 10/320, Platform/Chassis, 6x2	12.95 - 09.98				
FL 10/320, Platform/Chassis, 6x4	12.95 - 09.98				
FL 10/320, Truck Tractor, 4x2	12.95 - 09.98				

Vehicle list











					
---	---	---	--	---	---

VOLVO

FL 10 09.85 - 09.98

FL 10/320, Platform/Chassis, 8x2/4	12.95 - 09.98	D10A320	 4055.30.00	400 10 400GVZ	- GBox: R/SR1400/1700	
FL 10/320, Truck Tractor, 6x2	12.95 - 09.98	D10A320	 4300.90.76 ⊕	430 10 MFZ430 430GTZ	- GBox: R/SR1400/1700	
FL 10/320, Truck Tractor, 6x4	12.95 - 09.98		 4332.60.00			
			 4336.30.00			
			 4300.90.21 ⊕	430 10 MFZ430 430WGTZ	- GBox: R/SR1400/1700	
			 4332.60.00			
			 4323.30.00			
		 4304.26.00 ⊖	430 MFZ430	- GBox: R/SR62 - GBox: R/SR1400/1700		
		 3588.30.00	350 10 350GSZ	- GBox: R/SR62 - GBox: R/SR1400/1700 - Loose clutch disc		
		 3527.30.00	350 10 350GSZ	- GBox: R/SR1400/1700		
FL 10/360, Dump Truck, 4x2	12.95 - 09.98	D10A320	 4055.30.00	400 10 400GVZ	- GBox: R/SR1400/1700	
FL 10/360, Platform/Chassis, 4x2	12.95 - 09.98	D10A360	 4300.90.76 ⊕	430 10 MFZ430 430GTZ	- GBox: R/SR1400/1700	
FL 10/360, Platform/Chassis, 6x2	12.95 - 09.98					 4332.60.00
FL 10/360, Platform/Chassis, 6x2/4	12.95 - 09.98					 4336.30.00
FL 10/360, Platform/Chassis	12.95 - 09.98		 4300.90.21 ⊕	430 10 MFZ430 430WGTZ	- GBox: R/SR1400/1700	
FL 10/360, Platform/Chassis, 8x2/4	12.95 - 09.98					 4332.60.00
FL 10/360, Truck Tractor, 4x2	12.95 - 09.98		 4323.30.00			
FL 10/360, Truck Tractor, 6x2	12.95 - 09.98		 4304.26.00 ⊖	430 MFZ430	- GBox: R/SR62 - GBox: R/SR1400/1700	
FL 10/360, Truck Tractor, 6x4	12.95 - 09.98					 3527.30.00
FL 10H/320	12.95 - 09.98		D10A360	 3588.30.00	350 10 350GSZ	- GBox: R/SR62 - GBox: R/SR1400/1700
	12.95 - 09.98					
	12.95 - 09.98	 3588.30.00				
FL 10H/360	12.95 - 09.98					
	12.95 - 09.98					
	12.95 - 09.98					
	12.95 - 09.98					
	12.95 - 09.98					

FL 12 09.95 - 09.98

Mot. D 12 A	01.95 -	D12A380	 4300.90.33 ⊕	430 10 MFZ430 430WGTZ	- GBox: R/SR1700,1900	
FL 12/380, Platform/Chassis, 4x2	09.95 - 09.98					 4332.60.00
						 4331.30.00
		 8946.46.00	KZIZ-5			
		 8925.40.00	KZISZ-5			
FL 12/380, Platform/Chassis, 6x2	09.95 - 09.98	D12A380	 4300.90.33 ⊕	430 10 MFZ430 430WGTZ	- GBox: R/SR1700,1900	
FL 12/380, Platform/Chassis, 6x4	09.95 - 09.98	D12A420				 4332.60.00
FL 12/380, Truck Tractor, 4x2	09.95 - 09.98					 4331.30.00
FL 12/380, Truck Tractor, 6x4	09.95 - 09.98		 4304.26.00 ⊖	430 MFZ430	- GBox: R/SR1700,1900	
FL 12/420, Platform/Chassis, 4x2	09.95 - 09.98					
FL 12/420, Platform/Chassis, 6x2	09.95 - 09.98		 8946.46.00	KZIZ-5		
FL 12/420, Platform/Chassis, 6x4	09.95 - 09.98		 8925.40.00	KZISZ-5		
FL 12/420, Truck Tractor, 4x2	09.95 - 09.98					
FL 12/420, Truck Tractor, 6x4	09.95 - 09.98					
FL 12H/380, Dump Truck, 4x4	09.95 - 09.98					
FL 12H/380, Dump Truck, 6x4	09.95 - 09.98					
FL 12H/380, Dump Truck, 6x6	09.95 - 09.98					
FL 12H/380, Dump Truck, 8x4/4	09.95 - 09.98					
FL 12H/420	09.95 - 09.98					
	09.95 - 09.98					
	09.95 - 09.98					
FL 12/420	09.95 - 09.98					

Vehicle list

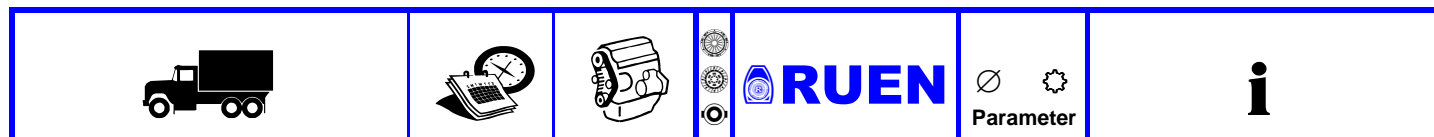

VOLVO

FL II 05.06 -

FL 240-12, Platform/Chassis	05.06 -	D7E240		3950.90.20	10	- GBox: ZTO1006, ZTO1109
FL 240-12, Dump Truck	05.06 -	D7E280		3961.20.00	MF395	
FL 240-14, Platform/Chassis	06.09 -	D7F240		3973.30.00	395WGTZ	
FL 240-14, Dump Truck	06.09 -	D7F260		8543.40.00	KZIS-4	
FL 240-15, Utility truck	05.06 -	D7F290				
FL 240-16, Platform/Chassis	05.06 -					
FL 240-16, Dump Truck	05.06 -					
FL 240-16, Utility truck	06.09 -					
FL 240-18, Platform/Chassis	05.06 -					
FL 260-12, Platform/Chassis	06.09 -					
FL 260-12, Dump Truck	06.09 -					
FL 260-14, Platform/Chassis	06.09 -					
FL 260-14, Dump Truck	06.09 -					
FL 260-15, Utility truck	06.09 -					
FL 260-16, Platform/Chassis	06.09 -					
FL 260-16, Dump Truck	06.09 -					
FL 260-18, Platform/Chassis	06.09 -					
FL 260-16, Utility truck	06.09 -					
FL 280-12, Platform/Chassis	05.06 -					
FL 280-12, Dump Truck	05.06 -					
FL 280-14, Platform/Chassis	06.09 -					
FL 280-14, Dump Truck	06.09 -					
FL 280-15, Utility truck	05.09 -					
FL 280-16, Platform/Chassis	05.09 -					
FL 280-16, Dump Truck	05.09 -					
FL 280-18, Platform/Chassis	05.09 -					
FL 290-12, Platform/Chassis	06.09 -					
FL 290-12, Dump Truck	06.09 -					
FL 290-14	06.09 -					
FL 290-16, Platform/Chassis	06.09 -					
FL 290-16, Dump Truck	06.09 -					
FL 290-16, Utility truck	06.09 -					
FL 290-18	06.09 -					

FL III 05.13 -

FL 210-10	05.13 -	D5K210		3961.20.00	395	- GBox: 6AS 800TO, 6AS 1000TO, 6S 800, 6S 1000TO
FL 210-12, Utility truck	05.13 -	D5K240			MF395	
FL 210-12, Platform/Chassis	05.13 -			8543.40.00	KZIS-4	- GBox: 6AS 800TO, 6AS 1000TO, 6S 800, 6S 1000TO
FL 210-14	05.13 -					
FL 210-16	05.13 -					
FL 240-10	05.13 -					
FL 240-12, 5132cc, Utility truck	05.13 -					
FL 240-12, 5132cc, Platform/Chassis	05.13 -					
FL 240-14, 5132cc, Platform/Chassis	05.13 -					
FL 240-16, 5132cc, Platform/Chassis	05.13 -					

Vehicle list

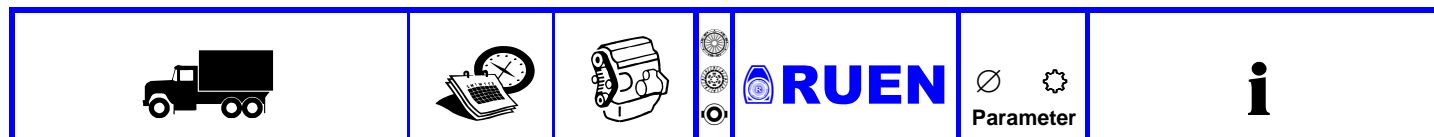

VOLVO

FL III 05.13 -

FL 240-12, 7146cc, Platform/Chassis	05.13 -	D7E240		3950.90.20	10	- GBox: ZTO 1006 / ZTO 1109
FL 240-14, 7146cc, Platform/Chassis	05.13 -	D7E280		3961.20.00	MF395	
FL 240-15	05.13 -	D7F240		3973.30.00	395WGTZ	
FL 240-16, Utility truck	05.13 -	D7F260		8543.40.00	KZIS-4	
FL 240-16, 7146cc, Platform/Chassis	05.13 -	D7F290		8641.47.00	PHIS-6/38	- GBox: AT 2412 D
FL 240-18	05.13 -					
FL 260-12	05.13 -					
FL 260-14	05.13 -					
FL 260-15	05.13 -					
FL 260-16, Utility truck	05.13 -					
FL 260-16, Platform/Chassis	05.13 -					
FL 260-18	05.13 -					
FL 280-12, 7146cc, Platform/Chassis, 4x2	05.13 -					
FL 280-14, 7146cc, Platform/Chassis, 4x2	05.13 -					
FL 280-16, 7146cc, Platform/Chassis	05.13 -					
FL 280-18, 7146cc, Platform/Chassis	05.13 -					
FL 290-12	05.13 -					
FL 290-14	05.13 -					
FL 290-16, Utility truck	05.13 -					
FL 290-16, Platform/Chassis	05.13 -					
FL 290-18	05.13 -					
FL 250-12, Platform/Chassis, 4x2	05.13 -	D8K250		3950.90.20	10	- GBox: ZF6S 1000 TO
FL 250-12, Platform/Chassis, 4x4	05.13 -	D8K280		3961.20.00	MF395	
FL 250-14, Platform/Chassis, 4x2	05.13 -			3973.30.00	395WGTZ	
FL 250-14, Platform/Chassis, 4x4	05.13 -			8543.40.00	KZIS-4	
FL 250-16, Utility truck, 4x2	05.13 -			3950.90.24	395 10	- GBox: ZF6AS 1000 TO
FL 250-16, Platform/Chassis, 4x2	05.13 -			3961.20.00	MF395	
FL 250-16, Platform/Chassis, 4x4	05.13 -			3974.30.00	395WGTZ	
FL 250-18	05.13 -			8543.40.00	KZIS-4	
FL 280-12, 7698cc, Platform/Chassis	05.13 -					
FL 280-12, 7698cc, Platform/Chassis, 4x4	05.13 -					
FL 280-14, 7698cc, Platform/Chassis	05.13 -					
FL 280-14, 7698cc, Platform/Chassis, 4x4	05.13 -					
FL 280-16, 7698cc, Platform/Chassis	05.13 -					
FL 280-16, 7698cc, Platform/Chassis, 4x4	06.13 -					
FL 280-18, 7698cc, Platform/Chassis	06.13 -					

FLC 09.96 - 09.00

FLC 140, Platform/Chassis	09.96 - 09.00	D4A140		8603.47.00	HHIS-3	
FLC 140, Dump Truck	09.96 - 09.00			3158.20.00	310 MF310	

Vehicle list



VOLVO

FM		09.05 -			
FM 420, Platform/Chassis	06.16 -	D13K420	⊙ 8641.47.00	PHIS-6/38	- GBox: AT 24112F / AT 2612F, ATO 2612F
FM 460, Platform/Chassis	06.16 -	D13K460	⊙ 4300.90.129 ⊕ ⊙ 4382.60.00 ⊙ 4398.30.00	430 24 MFZ430 430WGTZ	- GBox: VT2214B / VTO 2214B, VT2514B / VTO 2514B
FM 500, Platform/Chassis	06.16 -	D13K500			
FM 420, Truck Tractor	06.16 -				
FM 460, Truck Tractor	06.16 -				
FM 500, Truck Tractor	06.16 -				
FM 420, Platform/Chassis	06.16 -				
FM 460, Platform/Chassis	06.16 -				
FM 500, Platform/Chassis	06.16 -				
FM 420, Truck Tractor	06.16 -				
FM 460, Truck Tractor	06.16 -				
FM 500, Truck Tractor	06.16 -				
FM 420, 26.10t	06.16 -				
FM 460, 26.10t	06.16 -				
FM 500, 26.10t	06.16 -				
FM 420, 28.10t	06.16 -				
FM 460, 28.10t	06.16 -				
FM 500, 28.10t	06.16 -				
FM 420, 33.50t	06.16 -				
FM 460, 33.50t	06.16 -				
FM 500, 33.50t	06.16 -				
FM 420, 35t	06.16 -				
FM 460, 35t	06.16 -				
FM 500, 35t	06.16 -				
FM 420, 37t	06.16 -				
FM 460, 37t	06.16 -				
FM 500, 37t	06.16 -				
FM 420, 42t	06.16 -				
FM 460, 42t	06.16 -				
FM 500, 42t	06.16 -				
FM 330, 24t, Platform/Chassis, 6x2	06.16 -	D11K330	⊙ 4384.60.00	430 MFZ430	- GBox: VT 2009B
FM 370, 24t, Platform/Chassis, 6x2	06.16 -	D11K370	⊙ 8925.40.00	KZISZ-5	- GBox: VT 2009B
FM 410, 24t, Platform/Chassis, 6x2	06.16 -	D11K410			
FM 330, 23.50t, Truck Tractor, 6x2	06.16 -				
FM 370, 23.50t, Truck Tractor, 6x2	06.16 -		⊙ 4300.90.129 ⊕ ⊙ 4382.60.00 ⊙ 4398.30.00	430 24 MFZ430 430WGTZ	- GBox: VT2214B / VTO 2214B
FM 410, 23.50t, Truck Tractor, 6x2	06.16 -				
FM 330, 26.10t, 6x2	06.16 -				
FM 370, 26.10t, 6x2	06.16 -		⊙ 8946.46.00	KZIZ-5	
FM 410, 26.10t, 6x2	06.16 -				
FM 330, 35t, 8x2	06.16 -				
FM 370, 35t, 8x2	06.16 -				
FM 410, 35t, 8x2	06.16 -				
FM 330, 37t, 8x4	06.16 -				
FM 370, 37t, 8x4	06.16 -				
FM 410, 37t, 8x4	06.16 -				
FM 330, 42t	06.16 -				
FM 370, 42t	06.16 -				
FM 410, 42t	06.16 -				
FM 330, 35t	06.16 -				
FM 370, 35t	06.16 -				
FM 410, 35t	06.16 -				
FM 330, Truck Tractor	06.16 -				
FM 370, Truck Tractor	06.16 -				
FM 410, Truck Tractor	06.16 -				

Vehicle list



VOLVO

FM		09.05 -				
FM 450, 24t, Platform/Chassis, 6x2	09.05 -	D11K450		4300.90.129 ⊕	430 24	- GBox: VT2214B / VTO 2214B, VT2514B / VTO 2514B
FM 450, 23.50t, Truck Tractor, 6x2	06.16 -			4382.60.00	MFZ430	
FM 450, 26.10t, 6x2	06.16 -			4398.30.00	430WGTZ	
FM 450, 35t, 8x2	06.16 -					
FM 450, 37t, 8x4	06.16 -					
FM 450, 42t	06.16 -					
FM 450, 35t	06.16 -					
FM 450, Truck Tractor	06.16 -					
FM 300, 32t, Dump Truck, 8x4/4	09.05 -	D9A300		8641.47.00	PHIS-6/38	- Engine code: D9A300, D9B300
FM 300, 32t, Platform/Chassis, 8x4/4	09.05 -	D9B300				- GBox: AT2412C, AT2512C
FM 300, 18t, Dump Truck, 4x2	09.05 -			8925.40.00	KZISZ-5	- Engine code: D9A300, D9B300
FM 300, 26t, Dump Truck, 6x4	09.05 -					- GBox: VT2009B
FM 300, 26t, Dump Truck, 6x6	09.05 -			4333.60.00 ⊕	430	- Engine code: D9B300
FM 300, 18t, Platform/Chassis, 4x2	09.05 -			4332.60.00 ⊕	MFZ430	- GBox: VT2214B, VTO2214B
FM 300, 18t, Platform/Chassis, 4x4	09.05 -					
FM 300, 26t, Platform/Chassis, 6x2	09.05 -			4329.30.00	430 24	- Engine code: D9B300
FM 300, 32t, Platform/Chassis, 6x2/4	09.05 -				430WGTZ.	- GBox: AT2412C, AT2512C
FM 300, 26t, Platform/Chassis, 6x4	09.05 -			8946.46.00	KZIZ-5	
FM 300, 32t, Platform/Chassis, 8x2/4	09.05 -					
FM 300, 32t, Platform/Chassis, 8x2/6	09.05 -					
FM 300, 18t, Truck Tractor, 4x2	09.05 -					
FM 300, 26t, Truck Tractor, 6x2	09.05 -					
FM 300, 26t, Truck Tractor, 6x4	09.05 -					
FM 330, 21t, 4x2	09.05 -	D11C330		4000.90.28	400 24	- Engine code: D11C330
FM 330, 35t, 6x4	09.05 -	D11K330		4027.10.00	MFZ2/400X	- GBox: VT2214B, VT2514B, VTO2214B, VTO2514B
FM 330, 35t, 6x6	09.05 -			4032.30.00	400WGTZ	
FM 330, 42t, 8x4/4	09.05 -			4300.90.118 ⊕	430 24	- Engine code: D11C330
FM 330, 21t, 4x2	09.05 -			4384.60.00	MFZ430	- GBox: VT2009B
FM 330, 21t, 4x4	09.05 -			4389.30.00	430WGTZ	
FM 330, 27t, 6x2	09.05 -			4300.90.106 ⊕	430 24	- Engine code: D11C330
FM 330, 27t, 6x2/4	09.05 -			4382.60.00	MFZ430	- GBox: VT2214B, VT2514B, VTO2214B, VTO2514B
FM 330, 29t, 6x4	09.05 -			4389.30.00	430WGTZ	
FM 330, 35t, 8x2/4	09.05 -			8641.47.00	PHIS-6/38	- Engine code: D11C330
FM 330, 35t, 8x2/6	09.05 -					- GBox: AT2412D, AT2612D, ATO2612D
FM 330, 37t, 8x4/4	09.05 -			4329.30.00	430 24	- Engine code: D11C330
FM 330, 21t, 4x2	09.05 -				430WGTZ.	- GBox: AT2412D, AT2612D, ATO2612D
FM 330, 21t, 4x4	09.05 -					
FM 330, 25t, 6x2	09.05 -					
FM 330, 25t, 6x2/4	09.05 -					
FM 330, 35t, 6x6	09.05 -					
FM 330, 18.60t, Platform/Chassis, 4x2	04.12 -	D11C330		4329.30.00	430 24	- Engine code: D9B300
FM 330, 20.10t, Platform/Chassis, 4x2	04.12 -	D11K330			430WGTZ.	- GBox: AT2412C, AT2512C
FM 330, 34t, Platform/Chassis, 6x4	04.12 -			8641.47.00	PHIS-6/38	- Engine code: D9B300
FM 330, 35, 42t, Platform/Chassis, 8x4/4	04.12 -					- GBox: AT2412C, AT2512C
FM 330, 18.60, 20.10t, Truck Tractor, 4x2	04.12 -			4333.60.00 ⊕	430	- Engine code: D9B300
FM 330, 26.50t, Off-Road Vehicle, 6x2	04.12 -			4332.60.00 ⊕	MFZ430	- GBox: VT2214B, VTO2214B
FM 330, 26.50t, Truck Tractor, 6x2/4	04.12 -					- Engine code: D9B300
FM 330, 28.50, 29, 33.50t, Truck Tractor, 6x4	04.12 -					- GBox: VT2009B
FM 330, 35t, Truck Tractor, 8x4/4	04.12 -					

Vehicle list

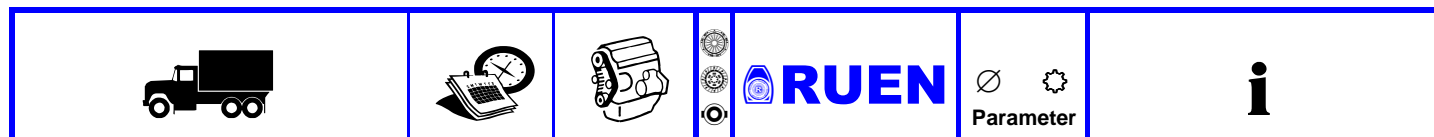

VOLVO

FM		09.05 -				
FM 340, 18t, Dump Truck, 4x2	09.05 -	D9A340		4329.30.00	430 24 430WGTZ.	- Engine code: D9B340 - GBox: AT2412C,AT2512C
FM 340, 26t, Dump Truck, 6x4	09.05 -	D9B340		8641.47.00	PHIS-6/38	- Engine code: D9B340 - GBox: AT2412C,AT2512C
FM 340, 26t, Dump Truck, 6x6	09.05 -			4300.90.35 ⊕	430 24 MFZ430	- Engine code: D9B340 - GBox: VT2214B,VTO2214B
FM 340, 32t, Dump Truck, 8x4/4	09.05 -			4333.60.00	430WGTZ	
FM 340, Platform/Chassis, 4x2	09.05 -			4325.30.00		
FM 340, Platform/Chassis, 4x4	09.05 -			4300.90.16 ⊕	430 24 MFZ430	- Engine code: D9B340 - GBox: VT2009B
FM 340, Platform/Chassis, 6x2	09.05 -			4332.60.00	430WGTZ	
FM 340, Platform/Chassis, 6x2/4	09.05 -			4325.30.00		
FM 340, Platform/Chassis, 6x4	09.05 -					
FM 340, Platform/Chassis, 8x2/4	09.05 -					
FM 340, Platform/Chassis, 8x2/6	09.05 -					
FM 340, Platform/Chassis, 8x4/4	09.05 -					
FM 340, Truck Tractor, 4x2	09.05 -					
FM 340, Truck Tractor, 4x4	09.05 -					
FM 340, Truck Tractor, 6x2	09.05 -					
FM 340, Truck Tractor, 6x4	09.05 -					
FM 360, Dump Truck, 4x2	09.05 -	D13A360		4300.90.106 ⊕	430 24 MFZ430	- Engine code: D13A360, D13B360 - GBox: VT2214B, VT2514B, VTO2214B, VTO2514B
FM 360, Dump Truck, 6x4	09.05 -	D13B360		4382.60.00	430WGTZ	
FM 360, Dump Truck, 6x6	09.05 -			4389.30.00		
FM 360, Dump Truck, 8x4/4	09.05 -			4398.30.00	430 24 430WGTZ	- Engine code: D13A360, D13B360 - GBox: AT2412C, AT2512C, ATO2512C
FM 360, Platform/Chassis, 4x4	09.05 -			8641.47.00	PHIS-6/38	- Engine code: D13A360, D13B360 - GBox: AT2412C, AT2512C, ATO2512C
FM 360, Platform/Chassis, 6x4	09.05 -			4300.90.118 ⊕	430 24 MFZ430	- Engine code: D13A360, D13B360 - GBox: VT2009B
FM 360, Platform/Chassis, 8x2/4	09.05 -			4384.60.00	430WGTZ	
FM 360, Platform/Chassis, 8x2/6	09.05 -			4389.30.00		
FM 360, Platform/Chassis, 8x4/4	09.05 -			4000.90.28	400 24 MFZ2/400X	- Engine code: D13A360, D13B360
FM 360, Truck Tractor, 4x4	09.05 -			4027.10.00	400WGTZ	
FM 360, Truck Tractor, 6x2	09.05 -			4032.30.00		
FM 360, Truck Tractor, 6x4	09.05 -					
FM 360, Truck Tractor, 6x6	09.05 -					
FM 360, Platform/Chassis, 4x2	11.05 -					
FM 360, Platform/Chassis, 6x2	11.05 -					
FM 360, Truck Tractor, 4x2	11.05 -					

Vehicle list



VOLVO

FM		09.05 -			
FM 370, Dump Truck, 4x2	09.05 -	D11C330	4000.90.28	400 24	- Engine code: D11C370
FM 370, Dump Truck, 6x4	09.05 -	D11C370	4027.10.00	MFZ2/400X	- Engine code: D11C410
FM 370, Dump Truck, 6x6	09.05 -	D11C410	4032.30.00	400WGTZ	- GBox: VT2214B, VT2514B, VTO2214B, VTO2514B
FM 370, Dump Truck, 8x4/4	09.05 -	D11K370	4329.30.00	430 24	- Engine code: D11C370
FM 370, Platform/Chassis, 4x2	09.05 -	D11K410		430WGTZ.	- Engine code: D11C410
FM 370, Platform/Chassis, 4x4	09.05 -				- GBox: AT2412D, AT2612D, ATO2612D
FM 370, Platform/Chassis, 6x2	09.05 -		4300.90.118 ⊕	430 24	- Engine code: D11C370
FM 370, Platform/Chassis, 6x2/4	09.05 -		4384.60.00	MFZ430	- Engine code: D11C410
FM 370, Platform/Chassis, 6x4	09.05 -		4389.30.00	430WGTZ	- GBox: VT2009B
FM 370, Platform/Chassis, 8x2/4	09.05 -		4300.90.106 ⊕	430 24	- Engine code: D11C370
FM 370, Platform/Chassis, 8x2/6	09.05 -		4382.60.00	MFZ430	- Engine code: D11C410
FM 370, Platform/Chassis, 8x4/4	09.05 -		4389.30.00	430WGTZ	- GBox: VT2214B, VT2514B, VTO2214B, VTO2514B
FM 370, Truck Tractor, 4x2	09.05 -		8641.47.00	PHIS-6/38	- Engine code: D11C370
FM 370, Truck Tractor, 4x4	09.05 -				- Engine code: D11C410
FM 370, Truck Tractor, 6x2	09.05 -				- GBox: AT2412D, AT2612D, ATO2612D
FM 370, Truck Tractor, 6x2/4	09.05 -				
FM 370, Truck Tractor, 6x6	09.05 -				
FM 370, Platform/Chassis, 4x2	04.12 -				
FM 370, Platform/Chassis, 6x4	04.12 -				
FM 370, Platform/Chassis, 8x4/4	04.12 -				
FM 370, Truck Tractor, 4x2	04.12 -				
FM 370, Truck Tractor, 6x2	04.12 -				
FM 370, Truck Tractor, 6x2/4	04.12 -				
FM 370, Truck Tractor, 6x4	04.12 -				
FM 370, Truck Tractor, 8x4/4	04.12 -				
FM 410, 10800cc, Dump Truck, 4x2	09.05 -				
FM 410, 10800cc, Dump Truck, 6x4	09.05 -				
FM 410, 10800cc, Dump Truck, 6x6	09.05 -				
FM 410, 10800cc, Dump Truck, 8x4/4	09.05 -				
FM 410, 10840cc, Platform/Chassis, 4x2	09.05 -				
FM 410, 10800cc, Platform/Chassis, 4x4	09.05 -				
FM 410, 10840cc, Platform/Chassis, 6x2	09.05 -				
FM 410, 10800cc, Platform/Chassis, 6x2/4	09.05 -				
FM 410, 10840cc, Platform/Chassis, 6x4	09.05 -				
FM 410, 10840cc, Platform/Chassis, 8x2/4	09.05 -				
FM 410, 10800cc, Platform/Chassis, 8x2/6	09.05 -				
FM 410, 10840cc, Platform/Chassis, 8x4/4	09.05 -				
FM 410, Truck Tractor, 4x2	09.05 -				
FM 410, Truck Tractor, 4x4	09.05 -				
FM 410, Truck Tractor, 6x2	09.05 -				
FM 410, Truck Tractor, 6x2/4	09.05 -				
FM 410, Truck Tractor, 6x6	09.05 -				
FM 410, Platform/Chassis, 4x2	04.12 -				
FM 410, Platform/Chassis, 6x4	04.12 -				
FM 410, Platform/Chassis, 8x4/4	04.12 -				
FM 410, Truck Tractor, 4x2	04.12 -				
FM 410, Truck Tractor, 6x2	04.12 -				
FM 410, Truck Tractor, 6x2/4	04.12 -				
FM 410, Truck Tractor, 6x4	04.12 -				
FM 410, Truck Tractor, 8x4/4	04.12 -				

Vehicle list



VOLVO

FM 09.05 -

FM 380, 280kW, 12800cc, 4x2	09.05 -	D13C380	4000.90.28	400 24	- Engine code: D13C380 - GBox: VT2214B, VT2514B, VTO2214B, VTO2514B
FM 380, 12800cc, 6x4	09.05 -		4027.10.00	MFZ2/400X	
FM 380, 12800cc, 6x6	09.05 -		4032.30.00	400WGTZ	
FM 380, 12800cc, 8x4/4	09.05 -		4000.90.29 ⊕	400 24	- GBox: VT 2214B / VTO 2214B, VT 2514B / VTO 2514B
FM 380, 12800cc, 4x2	09.05 -		4047.10.00	MFZ2/400X	- GBox: VT 2814B / VTO 2814B
FM 380, 12800cc, 4x4	09.05 -		4032.30.00	400WGTZ	- Vehicles with double disc clutch
FM 380, 12800cc, 28.50t	09.05 -		4398.30.00	430 24	- Engine code: D13C380 - GBox: AT2412D, AT2612D, ATO2612D
FM 380, 12800cc	09.05 -		4300.90.118 ⊕	430 24	- Engine code: D13C380 - GBox: VT2009B
	09.05 -		4384.60.00	MFZ430	
	09.05 -		4389.30.00	430WGTZ	
	09.05 -		4300.90.106 ⊕	430 24	- Engine code: D13C380 - GBox: VT2214B, VT2514B, VTO2214B, VTO2514B
	09.05 -		4382.60.00	MFZ430	
	09.05 -		4389.30.00	430WGTZ	
FM 380	09.05 -		8641.47.00	PHIS-6/38	- Engine code: D13C380 - GBox: AT2412D, AT2612D, ATO2612D
FM 380, 279kW, 9364cc, 4x2	09.05 -	D13C380	4329.30.00	430 24	- Engine code: D9B380 - GBox: AT2412C, AT2512C
FM 380, 9364cc, 6x4	09.05 -	D9B380		430WGTZ.	
FM 380, 9364cc, 6x6	09.05 -		8641.47.00	PHIS-6/38	- Engine code: D9B380 - GBox: AT2412C, AT2512C
FM 380, 9364cc, 8x4/4	09.05 -		4300.90.35 ⊕	430 24	- Engine code: D9B380 - GBox: VT2214B, VTO2214B
FM 380, 9364cc, 4x2	09.05 -		4333.60.00	MFZ430	
FM 380, 9364cc, 4x4	09.05 -		4325.30.00	430WGTZ	
FM 380, 6x2	09.05 -		4300.90.16 ⊕	430 24	- Engine code: D9B380 - GBox: VT2009B
FM 380, 6x2/4	09.05 -		4332.60.00	MFZ430	
FM 380, 9364cc, 26t	09.05 -		4325.30.00	430WGTZ	
FM 380, 9364cc	09.05 -				
	09.05 -				
	09.05 -				
	09.05 -				
	09.05 -				
	09.05 -				
	09.05 -				

Vehicle list

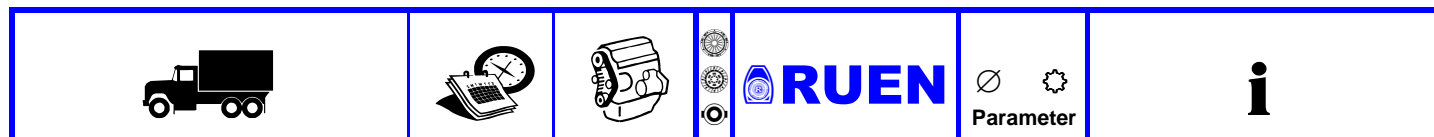

VOLVO

FM		09.05 -		
FM 380, 4x2	04.12 -	D13C380	4000.90.29 ⊕	400 24 MFZ2/400X 400WGTZ - GBox: VT 2214B / VTO 2214B, VT 2514B / VTO 2514B, - GBox: VT 2814B / VTO 2814B - Vehicles with double disc clutch
FM 380, 6x2	04.12 -	D11B390	4047.10.00	
FM 380, 6x2/4	04.12 -	D12C420	4032.30.00	
FM 380, 6x4	04.12 -	D13C420		
FM 380, 8x2/4	04.12 -	D13C460		
FM 380, 8x4/4	04.12 -	D13C500		
FM 380, 4x2	04.12 -	D13K420		
FM 380, 6x2	04.12 -	D13K460		
FM 380, 6x2/4	04.12 -	D13K500		
FM 380, 6x4	04.12 -			
FM 380, 8x4/4	04.12 -			
FM 390, Platform/Chassis, 4x2	06.08 -			
FM 390, Platform/Chassis, 6x2	06.08 -			
FM 390, Platform/Chassis, 6x4	06.08 -			
FM 390, Truck Tractor, 4x2	06.08 -			
FM 390, Truck Tractor, 6x2	06.08 -			
FM 390, Truck Tractor, 6x4	06.08 -			
FM 420, Platform/Chassis, 4x2	04.12 -			
FM 420, Platform/Chassis, 6x2	04.12 -			
FM 420, Platform/Chassis, 6x2/4	04.12 -			
FM 420, Platform/Chassis, 6x4	04.12 -			
FM 420, Platform/Chassis, 8x2/4	04.12 -			
FM 420, Platform/Chassis, 8x4/4	04.12 -			
FM 420, Truck Tractor, 4x2	04.12 -			
FM 420, Truck Tractor, 6x2	04.12 -			
FM 420, Truck Tractor, 6x2/4	04.12 -			
FM 420, Truck Tractor, 6x4	04.12 -			
FM 420, Truck Tractor, 8x4/4	04.12 -			
FM 460, Platform/Chassis, 4x2	04.12 -			
FM 460, Platform/Chassis, 6x2	04.12 -			
FM 460, Platform/Chassis, 6x2/4	04.12 -			
FM 460, Platform/Chassis, 6x4	04.12 -			
FM 460, Platform/Chassis, 8x2/4	04.12 -			
FM 460, Platform/Chassis, 8x4/4	04.12 -			
FM 460, Truck Tractor, 4x2	04.12 -			
FM 460, Truck Tractor, 6x2	04.12 -			
FM 460, Truck Tractor, 6x2/4	04.12 -			
FM 460, Truck Tractor, 6x4	04.12 -			
FM 460, Truck Tractor, 8x4/4	04.12 -			
FM 500, Platform/Chassis, 4x2	04.12 -			
FM 500, Platform/Chassis, 6x2	04.12 -			
FM 500, Platform/Chassis, 6x2/4	04.12 -			
FM 500, Platform/Chassis, 6x4	04.12 -			
FM 500, Platform/Chassis, 8x2/4	04.12 -			
FM 500, Platform/Chassis, 8x4/4	04.12 -			
FM 500, Truck Tractor, 4x2	04.12 -			
FM 500, Truck Tractor, 6x2	04.12 -			
FM 500, Truck Tractor, 6x2/4	04.12 -			
FM 500, Truck Tractor, 6x4	04.12 -			
FM 500, Truck Tractor, 8x4/4	04.12 -			

Vehicle list

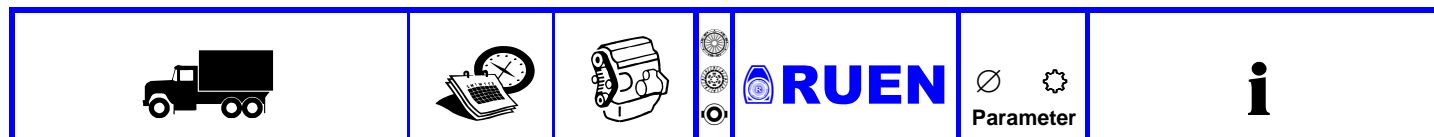

VOLVO

FM		09.05 -				
FM 400, Dump Truck, 4x2	09.05 -	D13A400 D13B400		4300.90.106 ⊕ 4382.60.00 4389.30.00	430 24 MFZ430 430WGTZ	- Engine code: D13A400, D13B400 - GBox: VT2214B, VT2514B, VTO2214B, VTO2514B
FM 400, Dump Truck, 6x4	09.05 -					
FM 400, Dump Truck, 6x6	09.05 -					
FM 400, Dump Truck, 8x4/4	09.05 -					
FM 400, Platform/Chassis, 4x2	09.05 -					
FM 400, Platform/Chassis, 4x4	09.05 -					
FM 400, Platform/Chassis, 6x2	09.05 -					
FM 400, Platform/Chassis, 6x4	09.05 -					
FM 400, Platform/Chassis, 8x2/4	09.05 -					
FM 400, Platform/Chassis, 8x2/6	09.05 -					
FM 400, Platform/Chassis, 8x4/4	09.05 -					
FM 400, Truck Tractor, 4x2	09.05 -					
FM 400, Truck Tractor, 4x4	09.05 -					
FM 400, Truck Tractor, 6x2	09.05 -					
FM 400, Truck Tractor, 6x4	09.05 -					
FM 400, Truck Tractor, 6x6	09.05 -					
FM 420, Dump Truck, 4x2	09.05 -	D13C420 D13K420		4000.90.28 4027.10.00 4032.30.00	400 24 MFZ2/400X 400WGTZ	- Engine code: D13C420 - GBox: VT2214B, VT2514B, VTO2214B, VTO2514B
FM 420, Dump Truck, 6x4	09.05 -					
FM 420, Dump Truck, 6x6	09.05 -					
FM 420, Dump Truck, 8x4/4	09.05 -					
FM 420, Platform/Chassis, 4x2	09.05 -					
FM 420, Platform/Chassis, 4x4	09.05 -					
FM 420, Platform/Chassis, 6x4	09.05 -					
FM 420, Platform/Chassis, 8x2/4	09.05 -					
FM 420, Platform/Chassis, 8x2/6	09.05 -					
FM 420, Platform/Chassis, 8x4/4	09.05 -					
FM 420, Truck Tractor, 4x2	09.05 -					
FM 420, Truck Tractor, 4x4	09.05 -					
FM 420, Truck Tractor, 6x2	09.05 -					
FM 420, Truck Tractor, 6x4	09.05 -					
FM 420, Truck Tractor, 6x6	09.05 -					
FM 420, 42t	04.12 -	D13K420 D13K460		8641.47.00	PHIS-6/38	- GBox: AT 24112F / AT 2612F, ATO 2612F
FM 420						
FM 460, 42t, Platform/Chassis	04.12 -					
				4300.90.129 ⊕ 4382.60.00 4398.30.00	430 24 MFZ430 430WGTZ	- GBox: VT2214B / VTO 2214B, VT2514B / VTO 2514B

Vehicle list



VOLVO

FM		09.05 -				
FM 440, Dump Truck, 4x2	09.05 -	D13A440	4300.90.106 ⊕	430 24	- Engine code: D13A440, D13B440	
FM 440, Dump Truck, 6x4	09.05 -	D13A480	4382.60.00	MFZ430	- Engine code: D13A480	
FM 440, Dump Truck, 6x6	09.05 -	D13B440	4389.30.00	430WGTZ	- GBox: VT2214B, VT2514B, VTO2214B, VTO2514B	
FM 440, Dump Truck, 8x4/4	09.05 -		4398.30.00	430 24	- Engine code: D13A440, D13B440	
FM 440, Platform/Chassis, 4x2	09.05 -			430WGTZ	- Engine code: D13A480	
FM 440, Platform/Chassis, 4x4	09.05 -				- GBox: AT2412C, AT2512C, ATO2512C	
FM 440, Platform/Chassis, 6x2	09.05 -		8641.47.00	PHIS-6/38	- Engine code: D13A440, D13B440	
FM 440, Platform/Chassis, 6x4	09.05 -				- Engine code: D13A480	
FM 440, Platform/Chassis, 8x2/4	09.05 -				- GBox: AT2412C, AT2512C, ATO2512C	
FM 440, Platform/Chassis, 8x4/4	09.05 -		4000.90.28	400 24	- Engine code: D13A440, D13B440	
FM 440, Truck Tractor, 4x2	09.05 -		4027.10.00	MFZ2/400X	- Engine code: D13A480	
FM 440, Truck Tractor, 4x4	09.05 -		4032.30.00	400WGTZ		
FM 440, Truck Tractor, 6x2	09.05 -		4027.60.00 ⊕	400	- Engine code: D13A440, D13B440	
FM 440, Truck Tractor, 6x4	09.05 -			MFZ2/400X	- Engine code: D13A480	
FM 440, Truck Tractor, 6x6	09.05 -					
FM 480, Dump Truck, 4x2	09.05 -					
FM 480, Dump Truck, 6x2	09.05 -					
FM 480, Dump Truck, 6x4	09.05 -					
FM 480, Dump Truck, 6x6	09.05 -					
FM 480, Dump Truck, 8x4/4	09.05 -					
FM 480, Platform/Chassis, 4x2	09.05 -					
FM 480, Platform/Chassis, 4x4	09.05 -					
FM 480, Platform/Chassis, 6x2	09.05 -					
FM 480, Platform/Chassis, 6x4	09.05 -					
FM 480, Platform/Chassis, 8x2/4	09.05 -					
FM 480, Platform/Chassis, 8x2/6	09.05 -					
FM 480, Platform/Chassis, 8x4/4	09.05 -					
FM 480, Truck Tractor, 4x2	09.05 -					
FM 480, Truck Tractor, 4x4	09.05 -					
FM 480, Truck Tractor, 6x2	09.05 -					
FM 480, Truck Tractor, 6x4	09.05 -					
FM 480, Truck Tractor, 6x6	09.05 -					







Vehicle list































VOLVO

FM		09.05 -				
FM 450, Dump Truck, 4x2	09.05 -	D11C450		4000.90.28	400 24	- Engine code: D11C450
FM 450, Dump Truck, 6x4	09.05 -	D11K450		4027.10.00	MFZ2/400X	- GBox: VT2214B, VT2514B, VTO2214B, VTO2514B
FM 450, Dump Truck, 6x6	09.05 -			4032.30.00	400WGTZ	
FM 450, Dump Truck, 8x4/4	09.05 -			4398.30.00	430 24	- Engine code: D11C450
FM 450, Platform/Chassis, 4x2	09.05 -				430WGTZ	- GBox: AT2412D, AT2612D, ATO2612D
FM 450, Platform/Chassis, 4x4	09.05 -			8641.47.00	PHIS-6/38	- Engine code: D11C450
FM 450, Platform/Chassis, 6x2	09.05 -					- GBox: AT2412D, AT2612D, ATO2612D
FM 450, Platform/Chassis, 6x2/4	09.05 -			4300.90.118 ⊕	430 24	- Engine code: D11C450
FM 450, Platform/Chassis, 6x4	09.05 -			4384.60.00	MFZ430	- Engine code: D11C450
FM 450, Platform/Chassis, 6x4	09.05 -			4389.30.00	430WGTZ	- GBox: VT2009B
FM 450, Platform/Chassis, 8x2/4	09.05 -			4300.90.106 ⊕	430 24	- Engine code: D11C450
FM 450, Platform/Chassis, 8x2/6	09.05 -			4382.60.00	MFZ430	- GBox: VT2214B, VT2514B, VTO2214B, VTO2514B
FM 450, Platform/Chassis, 8x4/4	09.05 -			4389.30.00	430WGTZ	
FM 450, Truck Tractor, 4x2	09.05 -					
FM 450, Truck Tractor, 4x4	09.05 -					
FM 450, Truck Tractor, 6x2	09.05 -					
FM 450, Truck Tractor, 6x2/4	09.05 -					
FM 450, Truck Tractor, 6x6	09.05 -					
FM 450, Platform/Chassis, 4x2	04.12 -					
FM 450, Platform/Chassis, 6x4	04.12 -					
FM 450, Platform/Chassis, 8x2/4	04.12 -					
FM 450, Platform/Chassis, 8x4/4	04.12 -					
FM 450, Truck Tractor, 4x2	04.12 -					
FM 450, Truck Tractor, 6x2	04.12 -					
FM 450, Truck Tractor, 6x2/4	04.12 -					
FM 450, Truck Tractor, 6x4	04.12 -					
FM 450, Truck Tractor, 8x4/4	04.12 -					
FM 460, Dump Truck, 4x2	09.05 -	D13B500		4000.90.28	400 24	- Engine code: D13C460
FM 460, Dump Truck, 6x4	09.05 -	D13C460		4027.10.00	MFZ2/400X	- Engine code: D13C500
FM 460, Dump Truck, 6x6	09.05 -	D13C500		4032.30.00	400WGTZ	- GBox: VT2214B, VT2514B, VTO2214B, VTO2514B
FM 460, Dump Truck, 8x4/4	09.05 -	D13K460		4000.90.29 ⊕	400 24	- GBox: VT 2214B / VTO 2214B, VT 2514B / VTO 2514B
FM 460, Platform/Chassis, 4x2	09.05 -			4047.10.00	MFZ2/400X	- GBox: VT 2814B / VTO 2814B
FM 460, Platform/Chassis, 4x4	09.05 -			4032.30.00	400WGTZ	- Vehicles with double disc clutch
FM 460, Platform/Chassis, 6x4	09.05 -			4398.30.00	430 24	- Engine code: D13C460
FM 460, Platform/Chassis, 8x2/4	09.05 -				430WGTZ	- Engine code: D13C500
FM 460, Platform/Chassis, 8x2/6	09.05 -					- GBox: AT2412D, AT2612D, ATO2612D
FM 460, Platform/Chassis, 8x4/4	09.05 -			8641.47.00	PHIS-6/38	- Engine code: D13C460
FM 460, Truck Tractor, 4x2	09.05 -					- Engine code: D13C500
FM 460, Truck Tractor, 4x4	09.05 -					- GBox: AT2412D, AT2612D, ATO2612D
FM 460, Truck Tractor, 6x2	09.05 -			4300.90.118 ⊕	430 24	- Engine code: D13C460
FM 460, Truck Tractor, 6x4	09.05 -			4384.60.00	MFZ430	- Engine code: D13C500
FM 460, Truck Tractor, 6x4	09.05 -			4389.30.00	430WGTZ	- GBox: VT2009B
FM 460, Truck Tractor, 6x6	09.05 -			4300.90.106 ⊕	430 24	- Engine code: D13C460
FM 500, Dump Truck, 4x2	09.05 -			4382.60.00	MFZ430	- Engine code: D13C500
FM 500, Dump Truck, 6x4	09.05 -			4389.30.00	430WGTZ	- GBox: VT2214B, VT2514B, VTO2214B, VTO2514B
FM 500, Dump Truck, 6x6	09.05 -					
FM 500, Dump Truck, 8x4/4	09.05 -					
FM 500, Platform/Chassis, 4x2	09.05 -					
FM 500, Platform/Chassis, 6x4	09.05 -					
FM 500, Platform/Chassis, 8x2/4	09.05 -					
FM 500, Platform/Chassis, 8x2/6	09.05 -					
FM 500, Platform/Chassis, 8x4/4	09.05 -					
FM 500, Truck Tractor, 4x2	09.05 -					
FM 500, Truck Tractor, 6x2	09.05 -					
FM 500, Truck Tractor, 6x4	09.05 -					

Vehicle list

					
---	---	---	--	---	---

VOLVO

FM 09.05 -					
FM 460 FM 500			 4300.90.129 ⊕  4382.60.00  4398.30.00	430 24 MFZ430 430WGTZ	- Engine code: D13K - GBox: VT 2814B / VTO 2814B - GBox: VT 2514B / VTO 2514B
			 8641.47.00	PHIS-6/38	- Engine code: D13K - GBox: AT 2412/E /AT 2612/E, ATO 2612/E - GBox: AT 2612/E /ATO 2612E
FM 500, Platform/Chassis	04.12 -	D13K500	 8641.47.00	PHIS-6/38	- GBox: AT 2612F / ATO 2612F
			 4300.90.129 ⊕  4382.60.00  4398.30.00	430 24 MFZ430 430WGTZ	- GBox: VT2214B / VTO 2214B
FM 520, 4x2	01.08 -	D13A520	 4300.90.106 ⊕  4382.60.00  4389.30.00	430 24 MFZ430 430WGTZ	- GBox: VT2214B, VT2514B, VTO2214B, VTO2514B
			 4398.30.00	430 24 430WGTZ	- GBox: AT2412C, AT2512C, ATO2512C
			 4000.90.28  4027.10.00  4032.30.00	400 24 MFZ2/400X 400WGTZ	
			 4027.60.00 ⊕	400 MFZ2/400X	
			 8641.47.00	PHIS-6/38	- GBox: AT2412C, AT2512C, ATO2512C
FM 7 08.98 - 12.01					
FM 7/250 FM 7/250, 25.00t, Platform/Chassis, 6x2 FM 7/250, 26.00t, Platform/Chassis, 6x2 FM 7/250, Dump Truck, 4x2 FM 7/250, Dump Truck, 6x4 FM 7/250, Truck Tractor, 4x2 FM 7/290, Platform/Chassis, 4x2 FM 7/290, 25.00t, Platform/Chassis, 6x2 FM 7/290, 26.00t, Platform/Chassis, 6x2 FM 7/290, Dump Truck, 4x2 FM 7/290, Dump Truck, 6x4 FM 7/290, Truck Tractor, 4x2	08.98 - 12.01 08.98 - 12.01 08.98 - 12.01 08.98 - 12.01 08.98 - 12.01 08.98 - 12.01 08.98 - 12.01 08.98 - 12.01 08.98 - 12.01 08.98 - 12.01 08.98 - 12.01 08.98 - 12.01	D7C250 D7C290	 4300.90.34 ⊕  4333.60.00  4331.30.00	430 10 MFZ430 430WGTZ	- GBox: VT2014,2514
			 4300.90.21 ⊕  4332.60.00  4323.30.00	430 10 MFZ430 430WGTZ	- GBox: R/SR1400
FM 9 12.01 - 09.05					
FM 9/260, Truck Tractor FM 9/260, Platform/Chassis FM 9/300, Truck Tractor FM 9/300, Platform/Chassis	12.01 - 09.05 12.01 - 09.05 12.01 - 09.05 12.01 - 09.05	D9A260 D9A300	 4332.60.00 ⊕  4333.60.00 ⊕	430 MFZ430 430 MFZ430	- GBox: VT1708B,VT2009B - GBox: VT2412B - GBox: VT2214B,VTO2214B
FM 9/340, Truck Tractor FM 9/340, Platform/Chassis FM 9/380, Truck Tractor FM 9/380, Platform/Chassis	12.01 - 09.05 12.01 - 09.05 12.01 - 09.05 12.01 - 09.05	D9A300 D9A380	 4300.90.16 ⊕  4332.60.00  4325.30.00	430 24 MFZ430 430WGTZ	- GBox: VT1708B,VT2009B

Vehicle list

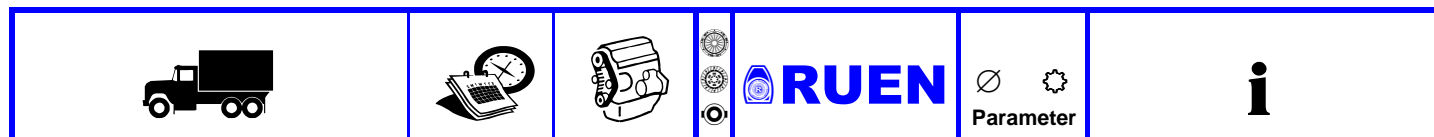

VOLVO

FM 9 12.01 - 09.05

FM 9/260, 4x4	12.01 - 09.05	D9A260		4333.60.00 ⊕	430 MFZ430	- GBox: VT2214B / VTO2214B, VT2514B
FM 9/260, Platform/Chassis, 6x2	12.01 - 09.05	D9A300				
FM 9/260, Truck Tractor, 6x2	12.01 - 09.05	D9B300				
FM 9/260, 6x4	12.01 - 09.05					
FM 9/260, 6x6	12.01 - 09.05					
FM 9/260, 8x2	12.01 - 09.05					
FM 9/260, 8x4	12.01 - 09.05					
FM 9/300, 4x4	12.01 - 09.05					
FM 9/300, Truck Tractor, 6x2	12.01 - 09.05					
FM 9/300, Platform/Chassis, 6x2	12.01 - 09.05					
FM 9/300, 6x4	12.01 - 09.05					
FM 9/300, 6x6	12.01 - 09.05					
FM 9/300, 8x2	12.01 - 09.05					
FM 9/300, 8x4	12.01 - 09.05					
FM 9/300, 8x4/4	12.01 - 09.05					
FM 9/340, Truck Tractor, 6x2	12.01 - 09.05	D9A340		4300.90.16 ⊕	430 24	- GBox: VT1708B,VT2009B
FM 9/340, Platform/Chassis, 6x2	12.01 - 09.05	D9A380		4332.60.00	MFZ430	
FM 9/340, Platform/Chassis, 6x4	12.01 - 09.05	D9B340		4325.30.00	430WGTZ	
FM 9/340, Platform/Chassis, 8x4/4	12.01 - 09.05			4300.90.35 ⊕	430 24	- GBox: VT2214B,VTO2214B
FM 9/380	12.01 - 09.05			4333.60.00	MFZ430	
	12.01 - 09.05			4325.30.00	430WGTZ	
				4304.26.00 ⊖	430 MFZ430	- GBox: VT1708B,VT2009B - GBox: VT2214B,VTO2214B

FM 10 09.98 - 12.01

FM 10/320, 4x2	04.99 - 12.01	D10B320		4300.90.21 ⊕	430 10	- GBox: S/SR1400/1700
FM 10/320, 6x2	04.99 - 12.01			4332.60.00	MFZ430	
FM 10/360, 4x2	04.99 - 12.01			4323.30.00	430WGTZ	
FM 10/360, 6x2	04.99 - 12.01					

Vehicle list

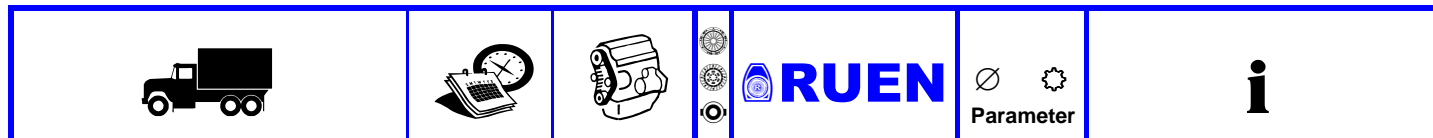

VOLVO

FM 12 09.98 - 09.05

FM 12/340, Platform/Chassis, 4x2	08.98 - 09.05	D12C340		4000.90.09 ⊕	400 24	
FM 12/340, 25.00t, Platform/Chassis, 6x2	08.98 - 09.05	D12D340		4027.60.00 4032.30.00	MFZ2/400X 400WGTZ	
FM 12/340, 26.00t, Platform/Chassis, 6x2	08.98 - 09.05			4000.90.08 ⊕	400 24	
FM 12/340, Platform/Chassis, 6x4	08.98 - 09.05			4027.10.00 4032.30.00	MFZ2/400X 400WGTZ	
FM 12/340, Platform/Chassis, 8x2/4	08.98 - 09.05			4001.50.00	400	- GBox: VT2214B, VTO2214B
FM 12/340, Platform/Chassis, 8x4/4	08.98 - 09.05			4000.90.10 ⊕	400 10	
FM 12H/340, Dump Truck, 8x4/4	08.98 - 09.05			4027.10.00 4033.30.00	MFZ2/400X 400WGTZ	
FM 12/340, Truck Tractor, 4x2	08.98 - 09.05			4300.90.34 ⊕	430 10	
FM 12/340, Truck Tractor, 6x4	08.98 - 09.05			4333.60.00 4331.30.00	MFZ430 430WGTZ	
				4300.90.33 ⊕	430 10	
				4332.60.00 4331.30.00	MFZ430 430WGTZ	
				4300.90.62 ⊕	430 24	
				4336.60.00 4329.30.00	MFZ430 430WGTZ.	
				4300.90.16 ⊕	430 24	
				4332.60.00 4325.30.00	MFZ430 430WGTZ	
				4304.26.00 ⊖	430	- GBox: VT2009B - GBox: VT2214B, VTO2214B
				4300.90.35 ⊕	430 24	
				4333.60.00 4325.30.00	MFZ430 430WGTZ	
				4047.10.00	400	- GBox: VT2214B, VTO2214B - Engine code: D12D340 - This part number includes one clutch disc
					MFZ2/400X	
FM 12/380, Platform/Chassis, 4x2	08.98 - 09.05	D12C380		4000.90.10 ⊕	400 10	
FM 12/380, 25.00t, Platform/Chassis, 6x2	08.98 - 09.05	D12D380		4027.10.00 4033.30.00	MFZ2/400X 400WGTZ	
FM 12/380, 26.00t, Platform/Chassis, 6x2	08.98 - 09.05			4300.90.34 ⊕	430 10	- GBox: VT2014, VT2014OD
FM 12/380, Platform/Chassis, 6x4	08.98 - 09.05			4333.60.00 4331.30.00	MFZ430 430WGTZ	
FM 12/380, Platform/Chassis, 8x2/4	08.98 - 09.05			4300.90.33 ⊕	430 10	
FM 12/380, Platform/Chassis, 8x4/4	08.98 - 09.05			4332.60.00 4331.30.00	MFZ430 430WGTZ	
FM 12H/380, Dump Truck, 8x4/4	08.98 - 09.05			4300.90.62 ⊕	430 24	
FM 12/380, Truck Tractor, 4x2	08.98 - 09.05			4336.60.00 4329.30.00	MFZ430 430WGTZ.	
FM 12/380, Truck Tractor, 6x4	08.98 - 09.05			4300.90.16 ⊕	430 24	
				4332.60.00 4325.30.00	MFZ430 430WGTZ	
				4304.26.00 ⊖	430	- GBox: VT2009B - GBox: VT2214B, VTO2214B
				4300.90.35 ⊕	430 24	
				4333.60.00 4325.30.00	MFZ430 430WGTZ	
				4047.10.00	400	- GBox: VT2214B, VTO2214B - Engine code: D12D340 - This part number includes one clutch disc
					MFZ2/400X	

Vehicle list

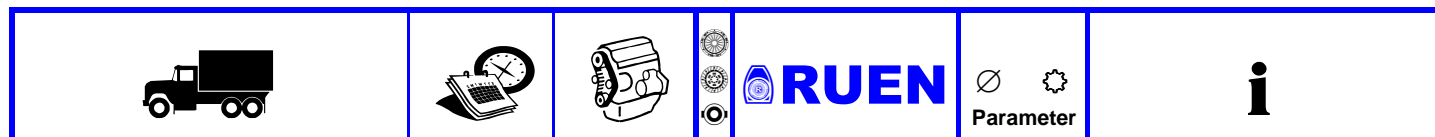

VOLVO

FM 12 09.98 - 09.05

FM 12/460, Platform/Chassis, 4x2	01.03 -			4300.90.16 ⊕	430 24	
FM 12/460, Truck Tractor, 4x2	01.03 -			4332.60.00	MFZ430	
FM 12/460, Platform/Chassis, 6x2	01.03 -			4325.30.00	430WGTZ	
FM 12/460, Platform/Chassis, 6x4	01.03 -			4300.90.35 ⊕	430 24	
FM 12/460, Truck Tractor, 6x4	01.03 -			4333.60.00	MFZ430	
FM 12/460, Platform/Chassis, 8x2/4	01.03 -			4325.30.00	430WGTZ	
FM 12/460, Platform/Chassis, 8x4/4	01.03 -			4000.90.10 ⊕	400 10	
FM 12H/460, Dump Truck, 8x4/4	01.03 -			4027.10.00	MFZ2/400X	
				4033.30.00	400WGTZ	
				4300.90.34 ⊕	430 10	
				4333.60.00	MFZ430	
				4331.30.00	430WGTZ	
				4300.90.33 ⊕	430 10	
				4332.60.00	MFZ430	
				4331.30.00	430WGTZ	
				4300.90.62 ⊕	430 24	
				4336.60.00	MFZ430	
				4329.30.00	430WGTZ.	
				4047.10.00	400	- GBox: VT2214B, VTO2214B
					MFZ2/400X	- Engine code: D12D340
						- This part number includes one clutch disc
FM 12/420, Platform/Chassis, 4x2	08.98 - 09.05	D12C420		4000.90.10 ⊕	400 10	
FM 12/420, 25.00t, Platform/Chassis, 6x2	08.98 - 09.05	D12D420		4027.10.00	MFZ2/400X	
FM 12/420, 26.00t, Platform/Chassis, 6x2	08.98 - 09.05			4033.30.00	400WGTZ	
FM 12/420, Platform/Chassis, 6x4	08.98 - 09.05			4300.90.34 ⊕	430 10	
FM 12/420, Platform/Chassis, 8x2/4	08.98 - 09.05			4333.60.00	MFZ430	
FM 12/420, Platform/Chassis, 8x4/4	08.98 - 09.05			4331.30.00	430WGTZ	
FM 12/420, Platform/Chassis, 8x4/4	08.98 - 09.05			4300.90.33 ⊕	430 10	
FM 12H/420, Dump Truck, 8x4/4	08.98 - 09.05			4332.60.00	MFZ430	
FM 12/420, Truck Tractor, 4x2	08.98 - 09.05			4331.30.00	430WGTZ	
FM 12/420, Truck Tractor, 6x4	08.98 - 09.05			4300.90.62 ⊕	430 24	
				4336.60.00	MFZ430	
				4329.30.00	430WGTZ.	
				4300.90.16 ⊕	430 24	
				4332.60.00	MFZ430	
				4325.30.00	430WGTZ	
				4304.26.00 ⊖	430	- GBox: VT2009B
					MFZ430	- GBox: VT2214B, VTO2214B
				4300.90.35 ⊕	430 24	- GBox: VT2214B, VTO2214B
				4333.60.00	MFZ430	
				4325.30.00	430WGTZ	
				4047.10.00	400	- GBox: VT2214B, VTO2214B
					MFZ2/400X	- Engine code: D12D340
						- This part number includes one clutch disc

Vehicle list



VOLVO

FMX 04.10 -

Vehicle Model	Year	Engine Code	Clutch Part Number	Clutch Size	Notes
330, Dump Truck, 4x2	04.10 -	D11C330	4000.90.28	400 24	- Engine code: D11C330
330, Dump Truck, 6x4	04.10 -		4027.10.00	MFZ2/400X	- GBox: VT2214B, VT2514B, VTO2214B,
330, Dump Truck, 6x6	04.10 -		4032.30.00	400WGTZ	VTO2514B
330, Dump Truck, 8x4/4	04.10 -		4329.30.00	430 24	- Engine code: D11C330
330, Platform/Chassis, 4x2	04.10 -			430WGTZ.	- GBox: AT2412D, AT2612D, ATO2612D
330, Platform/Chassis, 4x4	04.10 -		8641.47.00	PHIS-6/38	- Engine code: D11C330
330, Platform/Chassis, 6x2/4	04.10 -				- GBox: AT2412D, AT2612D, ATO2612D
330, Platform/Chassis, 6x2	04.10 -		4300.90.118	430 24	- Engine code: D11C330
330, Platform/Chassis, 6x4	04.10 -		4384.60.00	MFZ430	- GBox: VT2009B
330, Platform/Chassis, 6x4	04.10 -		4389.30.00	430WGTZ	
330, Platform/Chassis, 8x2	04.10 -		4300.90.106	430 24	- Engine code: D11C330
330, Platform/Chassis, 8x2/4	04.10 -		4382.60.00	MFZ430	- GBox: VT2214B, VT2514B, VTO2214B,
330, Platform/Chassis, 8x2/6	04.10 -		4389.30.00	430WGTZ	VTO2514B
330, Platform/Chassis, 8x4/4	04.10 -				
330, Platform/Chassis, 8x4	04.10 -				
330, Platform/Chassis, 8x6/4	04.10 -				
330, Truck Tractor, 4x2	04.10 -				
330, Truck Tractor, 4x4	04.10 -				
330, Truck Tractor, 6x2	04.10 -				
330, Truck Tractor, 6x2/4	04.10 -				
330, Truck Tractor, 6x4	04.10 -				
330, Truck Tractor, 6x6	04.10 -				
330, Truck Tractor, 8x4/4	04.10 -				

Vehicle list



VOLVO

FMX 04.10 -

Vehicle Model	Year	Code	Price	Parameter	Notes
370, Dump Truck, 4x2	04.10 -	D11A430	4300.90.129	430 24	- GBox: VT2214B / VTO 2214B
370, Dump Truck, 6x4	04.10 -	D11C370	4382.60.00	MFZ430	
370, Dump Truck, 6x6	04.10 -	D11C410	4398.30.00	430WGTZ	
370, Dump Truck, 8x4/4	04.10 -		4384.60.00	430 MFZ430	- GBox: VT 2009B
370, Platform/Chassis, 4x2	04.10 -		8925.40.00	KZISZ-5	- GBox: VT 2009B
370, Platform/Chassis, 4x4	04.10 -				
370, Platform/Chassis, 6x2	04.10 -				
370, Platform/Chassis, 6x2/4	04.10 -				
370, Platform/Chassis, 6x4	04.10 -				
370, Platform/Chassis, 8x2/4	04.10 -				
370, Platform/Chassis, 8x2/6	04.10 -				
370, Platform/Chassis, 8x4/4	04.10 -				
370, Platform/Chassis, 8x6/4	04.10 -				
370, Truck Tractor, 4x2	04.10 -				
370, Truck Tractor, 4x4	04.10 -				
370, Truck Tractor, 6x2	04.10 -				
370, Truck Tractor, 6x2/4	04.12 -				
370, Truck Tractor, 6x4	04.12 -				
370, Truck Tractor, 6x6	04.12 -				
370, Truck Tractor, 8x4/4	04.12 -				
410, Dump Truck, 4x2	04.10 -				
410, Dump Truck, 6x4	04.10 -				
410, Dump Truck, 6x6	04.10 -				
410, Dump Truck, 8x4/4	04.10 -				
410, Platform/Chassis, 4x2	04.10 -				
410, Platform/Chassis, 4x4	04.10 -				
410, Platform/Chassis, 6x2	04.10 -				
410, Platform/Chassis, 6x2/4	04.10 -				
410, Platform/Chassis, 6x4	04.10 -				
410, Platform/Chassis, 8x2/4	04.10 -				
410, Platform/Chassis, 8x2/6	04.10 -				
410, Platform/Chassis, 8x4/4	04.10 -				
410, Platform/Chassis, 8x6/4	04.10 -				
410, Truck Tractor, 4x2	04.10 -				
410, Truck Tractor, 4x4	04.10 -				
410, Truck Tractor, 6x2	04.10 -				
410, Truck Tractor, 6x2/4	04.10 -				
410, Truck Tractor, 6x4	04.10 -				
410, Truck Tractor, 6x6	04.10 -				
410, Truck Tractor, 8x4/4	04.10 -				
430, Platform/Chassis, 6x2/4	04.10 -				

Vehicle list

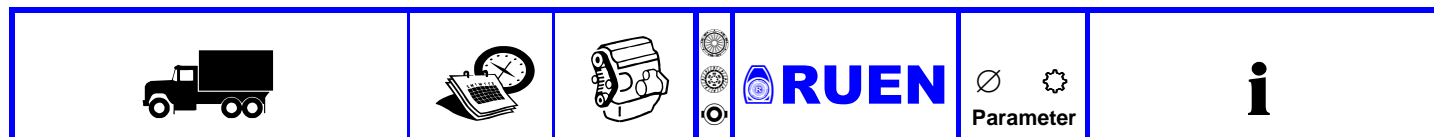

VOLVO

FMX 04.10 -

Vehicle Description	Year	Engine Code	Clutch Part Number	Clutch Specifications	Notes
380, Dump Truck, 4x2	04.10 -	D13C380	4000.90.28	400 24	- Engine code: D13C380
380, Dump Truck, 6x2	04.10 -		4027.10.00	MFZ2/400X	- GBox: VT2214B, VT2514B, VTO2214B, VTO2514B
380, Dump Truck, 6x2/4	04.10 -		4032.30.00	400WGTZ	
380, Dump Truck, 6x4	04.10 -		4000.90.29 ⊕	400 24	- GBox: VT 2214B / VTO 2214B, VT 2514B / VTO 2514B,
380, Dump Truck, 6x6	04.10 -		4047.10.00	MFZ2/400X	- GBox: VT 2814B / VTO 2814B
380, Dump Truck, 8x4	04.10 -		4032.30.00	400WGTZ	- Vehicles with double disc clutch
380, Platform/Chassis, 4x4	04.10 -		4398.30.00	430 24	- Engine code: D13C380
380, Platform/Chassis, 8x2	04.10 -			430WGTZ	- GBox: AT2412D, AT2612D, ATO2612D
			8641.47.00	PHIS-6/38	- Engine code: D13C380
					- GBox: AT2412D, AT2612D, ATO2612D
			4300.90.118 ⊕	430 24	- Engine code: D13C380
			4384.60.00	MFZ430	- GBox: VT2009B
			4389.30.00	430WGTZ	
			4300.90.106 ⊕	430 24	- Engine code: D13C380
			4382.60.00	MFZ430	- GBox: VT2214B, VT2514B, VTO2214B
			4389.30.00	430WGTZ	- GBox: VTO2514B

Vehicle list



VOLVO

FMX 04.10 -

Vehicle Model	Year	Code	Price	Configuration	Notes
380, Dump Truck, 8x4/4	04.10 -	D13C380	4000.90.29	400 24	- GBox: VT 2214B / VTO 2214B, VT 2514B / VTO 2514B
380, Platform/Chassis, 4x2	04.10 -	D13C420	4047.10.00	MFZ2/400X	- GBox: VT 2814B / VTO 2814B
380, Platform/Chassis, 6x2	04.10 -	D13C460	4032.30.00	400WGTZ	- Vehicles with double disc clutch
380, Platform/Chassis, 6x2/4	04.10 -				
380, Platform/Chassis, 6x4	04.10 -				
380, Platform/Chassis, 8x2/4	04.10 -				
380, Platform/Chassis, 8x2/6	04.10 -				
380, Platform/Chassis, 8x4/4	04.10 -				
380, Platform/Chassis, 8x6/4	04.10 -				
380, Truck Tractor, 4x2	04.10 -				
380, Truck Tractor, 4x4	04.10 -				
380, Truck Tractor, 6x2	04.10 -				
380, Truck Tractor, 6x2/4	04.10 -				
380, Truck Tractor, 6x4	04.10 -				
380, Truck Tractor, 6x6	04.10 -				
380, Truck Tractor, 8x4/4	04.10 -				
420, Dump Truck, 4x2	04.10 -				
420, Dump Truck, 6x4	04.10 -				
420, Dump Truck, 6x6	04.10 -				
420, Dump Truck, 8x4/4	04.10 -				
420, Platform/Chassis, 4x2	04.10 -				
420, Platform/Chassis, 4x4	04.10 -				
420, Platform/Chassis, 6x2	04.10 -				
420, Platform/Chassis, 6x2/4	04.10 -				
420, Platform/Chassis, 6x4	04.10 -				
420, Platform/Chassis, 8x2/4	04.10 -				
420, Platform/Chassis, 8x2/6	04.10 -				
420, Platform/Chassis, 8x4/4	04.10 -				
420, Platform/Chassis, 8x6/4	04.10 -				
420, Truck Tractor, 4x2	04.10 -				
420, Truck Tractor, 4x4	04.10 -				
420, Truck Tractor, 6x2	04.10 -				
420, Truck Tractor, 6x2/4	04.10 -				
420, Truck Tractor, 6x4	04.10 -				
420, Truck Tractor, 6x6	04.10 -				
420, Truck Tractor, 8x4/4	04.10 -				
460, Dump Truck, 4x2	04.10 -				
460, Dump Truck, 6x4	04.10 -				
460, Dump Truck, 6x6	04.10 -				
460, Dump Truck, 8x4/4	04.10 -				
460, Platform/Chassis, 4x2	04.10 -				
460, Platform/Chassis, 4x4	04.10 -				
460, Platform/Chassis, 6x2	04.10 -				
460, Platform/Chassis, 6x2/4	04.10 -				
460, Platform/Chassis, 6x4	04.10 -				
460, Platform/Chassis, 8x2/4	04.10 -				
460, Platform/Chassis, 8x2/6	04.10 -				
460, Platform/Chassis, 8x4/4	04.10 -				
460, Platform/Chassis, 8x6/4	04.10 -				

Vehicle list



VOLVO

FMX 04.10 -

460, Truck Tractor, 4x2	04.10 -	D13C460		4000.90.29 ⊕	400 24	- GBox: VT 2214B / VTO 2214B, VT 2514B / VTO 2514B
460, Truck Tractor, 4x4	04.10 -	D13C500		4047.10.00	MFZ2/400X	- GBox: VT 2814B / VTO 2814B
460, Truck Tractor, 6x2	04.10 -			4032.30.00	400WGTZ	- Vehicles with double disc clutch
460, Truck Tractor, 6x2/4	04.10 -					
460, Truck Tractor, 6x4	04.10 -					
460, Truck Tractor, 6x6	04.10 -					
460, Truck Tractor, 8x4/4	04.10 -					
500, Dump Truck, 4x2	04.10 -					
500, Dump Truck, 6x4	04.10 -					
500, Dump Truck, 6x6	04.10 -					
500, Dump Truck, 8x4/4	04.10 -					
500, Platform/Chassis, 4x2	04.10 -					
500, Platform/Chassis, 4x4	04.10 -					
500, Platform/Chassis, 6x2	04.10 -					
500, Platform/Chassis, 6x2/4	04.10 -					
500, Platform/Chassis, 6x4	04.10 -					
500, Platform/Chassis, 8x2/4	04.10 -					
500, Platform/Chassis, 8x2/6	04.10 -					
500, Platform/Chassis, 8x4/4	04.10 -					
500, Platform/Chassis, 8x6/4	04.10 -					
500, Truck Tractor, 4x2	04.10 -					
500, Truck Tractor, 4x4	04.10 -					
500, Truck Tractor, 6x2	04.10 -					
500, Truck Tractor, 6x2/4	04.10 -					
500, Truck Tractor, 6x4	04.10 -					
500, Truck Tractor, 6x6	04.10 -					
500, Truck Tractor, 8x4/4	04.10 -					
400, Truck Tractor, 6x4	04.10 -	D13B400		4300.90.106 ⊕	430 24	- Engine code: D13A400, D13B400
				4382.60.00	MFZ430	- GBox: VT2214B, VT2514B, VTO2214B, VTO2514B
				4389.30.00	430WGTZ	
				4398.30.00	430 24	- Engine code: D13A400, D13B400
				4300.90.118 ⊕	430 24	- GBox: AT2412C, AT2512C,, ATO2512C
				4384.60.00	MFZ430	- Engine code: D13A400, D13B400
				4389.30.00	430WGTZ	- GBox: VT2009B
				4000.90.28	400 24	- Engine code: D13A400, D13B400
				4027.10.00	MFZ2/400X	- Vehicles with double disc clutch
				4032.30.00	400WGTZ	
440, Truck Tractor, 6x4	04.10 -	D13A440		4000.90.28	400 24	- Engine code: D13A440, D13B440
480, Truck Tractor, 6x4	04.10 -	D13A480		4027.10.00	MFZ2/400X	- Engine code: D13A480
				4032.30.00	400WGTZ	- Vehicles with double disc clutch
				4300.90.106 ⊕	430 24	- Engine code: D13A440, D13B440
				4382.60.00	MFZ430	- Engine code: D13A480
				4389.30.00	430WGTZ	- GBox: VT2214B, VT2514B, VTO2214B, VTO2514B
				4398.30.00	430 24	- Engine code: D13A440, D13B440
					430WGTZ	- Engine code: D13A480
						- GBox: AT2412C, AT2512C, ATO2512C
				8641.47.00	PHIS-6/38	- Engine code: D13A440, D13B440
						- Engine code: D13A480
						- GBox: AT2412C, AT2512C, ATO2512C

Vehicle list



VOLVO

FMX 04.10 -

450, Dump Truck, 4x2	04.10 -	D11C450		4300.90.129 ⊕	430 24	- GBox: VT2214B / VTO 2214B, VT2514B / VTO 2514B
450, Dump Truck, 6x4	04.10 -			4382.60.00	MFZ430	
450, Dump Truck, 6x6	04.10 -			4398.30.00	430WGTZ	
450, Dump Truck, 8x4/4	04.10 -					
450, Platform/Chassis, 4x2	04.10 -					
450, Platform/Chassis, 4x4	04.10 -					
450, Platform/Chassis, 6x2	04.10 -					
450, Platform/Chassis, 6x2/4	04.10 -					
450, Platform/Chassis, 6x4	04.10 -					
450, Platform/Chassis, 8x2/4	04.10 -					
450, Platform/Chassis, 8x2/6	04.10 -					
450, Platform/Chassis, 8x4/4	04.10 -					
450, Platform/Chassis, 8x6/4	04.10 -					
450, Truck Tractor, 4x2	04.10 -					
450, Truck Tractor, 4x4	04.10 -					
450, Truck Tractor, 6x2	04.10 -					
450, Truck Tractor, 6x2/4	04.10 -					
450, Truck Tractor, 6x4	04.10 -					
450, Truck Tractor, 6x6	04.10 -					
450, Truck Tractor, 8x4/4	04.10 -					
540, Dump Truck, 4x2	04.10 -	D13C540		4300.90.129 ⊕	430 24	- GBox: VT2814B / VTO2814B
540, Dump Truck, 6x4	04.10 -			4382.60.00	MFZ430	
540, Dump Truck, 6x6	04.10 -			4398.30.00	430WGTZ	
540, Dump Truck, 8x4/4	04.10 -			8641.47.00	PHIS-6/38	- GBox: AT 2612F / ATO 2612F
540, Platform/Chassis, 4x2	04.10 -					
540, Platform/Chassis, 4x4	04.10 -					
540, Platform/Chassis, 6x2	04.10 -					
540, Platform/Chassis, 6x2/4	04.10 -					
540, Platform/Chassis, 6x4	04.10 -					
540, Platform/Chassis, 8x2/4	04.10 -					
540, Platform/Chassis, 8x2/6	04.10 -					
540, Platform/Chassis, 8x4/4	04.10 -					
540, Platform/Chassis, 8x6/4	04.10 -					
540, Truck Tractor, 4x2	04.10 -					
540, Truck Tractor, 4x4	04.10 -					
540, Truck Tractor, 6x2	04.10 -					
540, Truck Tractor, 6x2/4	04.10 -					
540, Truck Tractor, 6x4	04.10 -					
540, Truck Tractor, 6x6	04.10 -					
540, Truck Tractor, 8x4/4	04.10 -					

Vehicle list



VOLVO

FMX II 04.12 -

Vehicle Model	Year	Engine	Price	Clutch	Notes
330, Dump Truck, 4x2	04.12 -	D11K330	4300.90.129	430 24	- GBox: VT2214B / VTO 2214B
330, Dump Truck, 6x4	04.12 -	D11K370	4382.60.00	MFZ430	
330, Dump Truck, 6x6	04.12 -		4398.30.00	430WGTZ	
330, Platform/Chassis, 4x2	04.12 -		4384.60.00	430 MFZ430	- GBox: VT 2009B
330, Platform/Chassis, 4x4	04.12 -				
330, Platform/Chassis, 6x2/4	04.12 -		8925.40.00	KZISZ-5	- GBox: VT 2009B
330, Platform/Chassis, 6x4	04.12 -				
330, Dump Truck, 6x4	09.13 -				
330, Dump Truck, 6x6	09.13 -				
330, Dump Truck, 8x4/4	09.13 -				
330, Platform/Chassis, 6x2	09.13 -				
330, Platform/Chassis, 6x2/4	09.13 -				
330, Platform/Chassis, 6x4	09.13 -				
330, Platform/Chassis, 8x2/4	09.13 -				
330, Platform/Chassis, 8x2/6	09.13 -				
330, Platform/Chassis, 8x4/4	09.13 -				
330, Platform/Chassis, 8x6/4	09.13 -				
330, Truck Tractor, 4x2	09.13 -				
330, Truck Tractor, 4x4	09.13 -				
330, Truck Tractor, 6x2	09.13 -				
330, Truck Tractor, 6x2/4	09.13 -				
330, Truck Tractor, 6x4	09.13 -				
330, Truck Tractor, 6x6	09.13 -				
330, Truck Tractor, 8x4/4	09.13 -				
330, Dump Truck, 8x4	06.16 -				
330, Platform/Chassis, 6x6	06.16 -				
330, Platform/Chassis, 8x2	06.16 -				
330, Platform/Chassis, 8x4	06.16 -				
330, Truck Tractor, 4x2	06.16 -				
330, Truck Tractor, 6x2	06.16 -				
330, Truck Tractor, 8x4	06.16 -				
370, Dump Truck, 4x2	09.13 -				
370, Dump Truck, 6x4	09.13 -				
370, Dump Truck, 6x6	09.13 -				
370, Dump Truck, 8x4/4	09.13 -				
370, Platform/Chassis, 4x2	09.13 -				
370, Platform/Chassis, 4x4	09.13 -				
370, Platform/Chassis, 6x2	09.13 -				
370, Platform/Chassis, 6x2/4	09.13 -				
370, Platform/Chassis, 6x4	09.13 -				
370, Platform/Chassis, 8x2/4	09.13 -				
370, Platform/Chassis, 8x2/6	09.13 -				
370, Platform/Chassis, 8x4/4	09.13 -				
370, Platform/Chassis, 8x6/4	09.13 -				
370	09.13 -				
370, Truck Tractor, 4x2					

Vehicle list



VOLVO

FMX II

04.12 -

370, Truck Tractor, 4x4	09.13 -	D11K330		4300.90.129 ⊕	430 24	- GBox: VT2214B / VTO 2214B
370, Truck Tractor, 6x2	09.13 -	D16G750		4382.60.00	MFZ430	
370, Truck Tractor, 6x2/4	09.13 -	D11K370		4398.30.00	430WGTZ	
370, Truck Tractor, 6x4	09.13 -	D11K410		4384.60.00	430	- GBox: VT 2009B
370, Truck Tractor, 6x6	09.13 -				MFZ430	
370, Truck Tractor, 8x4/4	09.13 -			8925.40.00	KZISZ-5	- GBox: VT 2009B
370, Dump Truck, 8x4	06.16 -					
370, Platform/Chassis, 6x6	06.16 -					
370, Platform/Chassis, 8x2	06.16 -					
370, Platform/Chassis, 8x4	06.16 -					
370, Truck Tractor, 4x2	06.16 -					
370, Truck Tractor, 6x2	06.16 -					
370, Truck Tractor, 8x4	06.16 -					
380, Dump Truck	04.12 -					
410, Dump Truck, 4x2	09.13 -					
410, Dump Truck, 6x4	09.13 -					
410, Dump Truck, 6x6	09.13 -					
410, Dump Truck, 8x4/4	09.13 -					
410, Platform/Chassis, 4x2	09.13 -					
410, Platform/Chassis, 4x4	09.13 -					
410, Platform/Chassis, 6x2	09.13 -					
410, Platform/Chassis, 6x2/4	09.13 -					
410, Platform/Chassis, 6x4	09.13 -					
410, Platform/Chassis, 8x2/4	09.13 -					
410, Platform/Chassis, 8x2/6	09.13 -					
410, Platform/Chassis, 8x4/4	09.13 -					
410, Platform/Chassis, 8x6/4	09.13 -					
410, Truck Tractor, 4x2	09.13 -					
410, Truck Tractor, 4x4	09.13 -					
410, Truck Tractor, 6x2	09.13 -					
410, Truck Tractor, 6x2/4	09.13 -					
410, Truck Tractor, 6x4	09.13 -					
410, Truck Tractor, 6x6	09.13 -					
410, Truck Tractor, 8x4/4	09.13 -					
410, Dump Truck, 8x4	06.16 -					
410, Platform/Chassis, 6x6	06.16 -					
410, Platform/Chassis, 8x2	06.16 -					
410, Platform/Chassis, 8x4	06.16 -					
410, Truck Tractor, 4x2	06.16 -					
410, Truck Tractor, 6x2	06.16 -					
410, Truck Tractor, 8x4	06.16 -					

Vehicle list

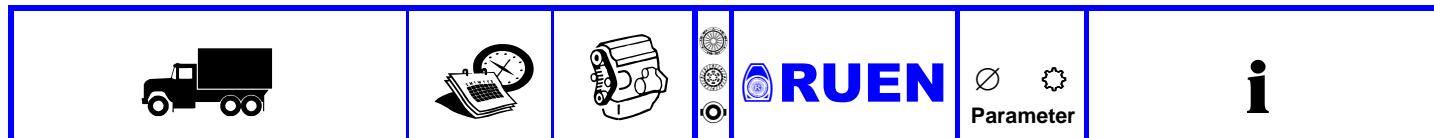

VOLVO

FMX II		04.12 -				
420, Dump Truck, 4x2	09.13 -	D13K420	8641.47.00	PHIS-6/38	- GBox: AT 24112F / AT 2612F, ATO 2612F	
420, Dump Truck, 6x4	09.13 -		4300.90.129 [⊕]	430 24	- GBox: VT2214B / VTO 2214B, VT2514B / VTO 2514B	
420, Dump Truck, 6x6	09.13 -		4382.60.00	MFZ430		
420, Dump Truck, 8x4/4	09.13 -		4398.30.00	430WGTZ		
420, Platform/Chassis, 4x2	09.13 -					
420, Platform/Chassis, 4x4	09.13 -					
420, Platform/Chassis, 6x2	09.13 -					
420, Platform/Chassis, 6x2/4	09.13 -					
420, Platform/Chassis, 6x4	09.13 -					
420, Platform/Chassis, 8x2/4	09.13 -					
420, Platform/Chassis, 8x2/6	09.13 -					
420, Platform/Chassis, 8x4/4	09.13 -					
420, Platform/Chassis, 8x6/4	09.13 -					
420, Truck Tractor, 4x2	09.13 -					
420, Truck Tractor, 4x4	09.13 -					
420, Truck Tractor, 6x2	09.13 -					
420, Truck Tractor, 6x2/4	09.13 -					
420, Truck Tractor, 6x4	09.13 -					
420, Truck Tractor, 6x6	09.13 -					
420, Truck Tractor, 8x4/4	09.13 -					
420, Dump Truck, 8x4	06.16 -					
420, Platform/Chassis, 6x6	06.16 -					
420, Platform/Chassis, 8x2	06.16 -					
420, Platform/Chassis, 8x4	06.16 -					
420, 43t, Platform/Chassis	06.16 -					
420, Truck Tractor, 4x2	06.16 -					
420, Truck Tractor, 8x4	06.16 -					
450, Dump Truck, 4x2	09.13 -	D11K450	4300.90.129 [⊕]	430 24	- GBox: VT2214B / VTO 2214B, VT2514B / VTO 2514B	
450, Dump Truck, 6x4	09.13 -		4382.60.00	MFZ430		
450, Dump Truck, 6x6	09.13 -		4398.30.00	430WGTZ		
450, Dump Truck, 8x4/4	09.13 -					
450, Platform/Chassis, 4x2	09.13 -					
450, Platform/Chassis, 4x4	09.13 -					
450, Platform/Chassis, 6x2	09.13 -					
450, Platform/Chassis, 6x2/4	09.13 -					
450, Platform/Chassis, 6x4	09.13 -					
450, Platform/Chassis, 8x2/4	09.13 -					
450, Platform/Chassis, 8x2/6	09.13 -					
450, Platform/Chassis, 8x4/4	09.13 -					
450, Platform/Chassis, 8x6/4	09.13 -					
450, Truck Tractor, 4x2	09.13 -					
450, Truck Tractor, 4x4	09.13 -					
450, Truck Tractor, 6x2	09.13 -					
450, Truck Tractor, 6x2/4	09.13 -					
450, Truck Tractor, 6x4	09.13 -					
450, Truck Tractor, 6x6	09.13 -					
450, Truck Tractor, 8x4/4	09.13 -					
450, Dump Truck, 8x4	06.16 -					
450, Platform/Chassis, 6x6	06.16 -					
450, Platform/Chassis, 8x2	06.16 -					
450, Platform/Chassis, 8x4	06.16 -					
450, Truck Tractor, 6x2	06.16 -					
450, Truck Tractor, 8x4	06.16 -					

Vehicle list

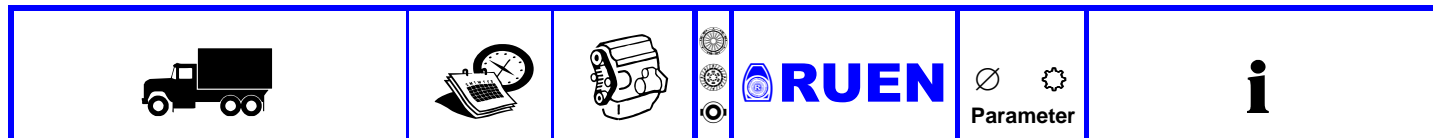

VOLVO

FMX II 04.12 -

460, Dump Truck, 4x2	09.13 -	D13K460		8641.47.00	PHIS-6/38	- GBox: AT 24112F / AT 2612F, ATO 2612F
460, Dump Truck, 6x4	09.13 -	D13K500				- GBox: AT 2612F / ATO 2612F
460, Dump Truck, 6x6	09.13 -			4300.90.129 [⊕]	430 24	- GBox: VT2214B / VTO 2214B, VT2514B / VTO 2514B
460, Dump Truck, 8x4/4	09.13 -			4382.60.00	MFZ430	
460, Platform/Chassis, 4x2	09.13 -			4398.30.00	430WGTZ	
460, Platform/Chassis, 4x4	09.13 -					
460, Platform/Chassis, 6x2	09.13 -					
460, Platform/Chassis, 6x2/4	09.13 -					
460, Platform/Chassis, 6x4	09.13 -					
460, Platform/Chassis, 8x2/4	09.13 -					
460, Platform/Chassis, 8x2/6	09.13 -					
460, Platform/Chassis, 8x4/4	09.13 -					
460, Platform/Chassis, 8x6/4	09.13 -					
460, Truck Tractor, 4x2	09.13 -					
460, Truck Tractor, 4x4	09.13 -					
460, Truck Tractor, 6x2	09.13 -					
460, Truck Tractor, 6x2/4	09.13 -					
460, Truck Tractor, 6x4	09.13 -					
460, Truck Tractor, 6x6	09.13 -					
460, Truck Tractor, 8x4/4	09.13 -					
460, Dump Truck, 8x4	06.16 -					
460, Platform/Chassis, 6x6	06.16 -					
460, Platform/Chassis, 8x2	06.16 -					
460, Platform/Chassis, 8x4	06.16 -					
460, 43t, Platform/Chassis	06.16 -					
460, Truck Tractor, 4x2	06.16 -					
460, Truck Tractor, 8x4	06.16 -					
500, Dump Truck, 4x2	09.13 -					
500, Dump Truck, 6x4	09.13 -					
500, Dump Truck, 6x6	09.13 -					
500, Dump Truck, 8x4/4	09.13 -					
500, Platform/Chassis, 4x2	09.13 -					
500, Platform/Chassis, 4x4	09.13 -					
500, Platform/Chassis, 6x2	09.13 -					
500, Platform/Chassis, 6x2/4	09.13 -					
500, Platform/Chassis, 6x4	09.13 -					
500, Platform/Chassis, 8x2/4	09.13 -					
500, Platform/Chassis, 8x2/6	09.13 -					
500, Platform/Chassis, 8x4/4	09.13 -					
500, Platform/Chassis, 8x6/4	09.13 -					
500, Truck Tractor, 4x2	09.13 -					
500, Truck Tractor, 4x4	09.13 -					
500, Truck Tractor, 6x2	09.13 -					
500, Truck Tractor, 6x2/4	09.13 -					
500, Truck Tractor, 6x4	09.13 -					
500, Truck Tractor, 6x6	09.13 -					
500, Truck Tractor, 8x4/4	09.13 -					
500, Dump Truck, 8x4	06.16 -					
500, Platform/Chassis, 6x6	06.16 -					
500, Platform/Chassis, 8x2	06.16 -					
500, Platform/Chassis, 8x4	06.16 -					
500, 43t, Platform/Chassis	06.16 -					
500, Truck Tractor, 4x2	06.16 -					
500, Truck Tractor, 8x4	06.16 -					

Vehicle list

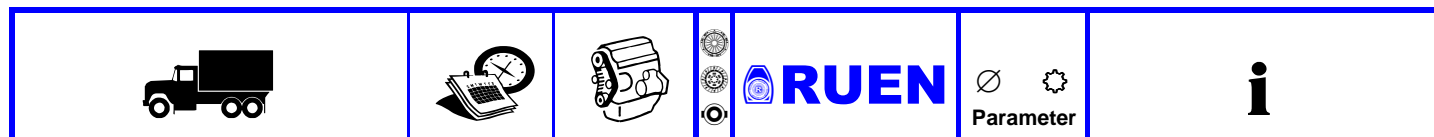

VOLVO







FMX II 04.12 -

540, Dump Truck, 4x2	09.13 -	D13K540		8641.47.00	PHIS-6/38	- GBox: AT 2612F / ATO 2612F
540, Dump Truck, 6x4	09.13 -			4300.90.129 [⊕]	430 24	- GBox: VT2814B / VTO2814B
540, Dump Truck, 6x6	09.13 -			4382.60.00	MFZ430	
540, Dump Truck, 8x4/4	09.13 -			4398.30.00	430WGTZ	
540, Platform/Chassis, 4x2	09.13 -					
540, Platform/Chassis, 4x4	09.13 -					
540, Platform/Chassis, 6x2	09.13 -					
540, Platform/Chassis, 6x2/4	09.13 -					
540, Platform/Chassis, 6x4	09.13 -					
540, Platform/Chassis, 8x2/4	09.13 -					
540, Platform/Chassis, 8x2/6	09.13 -					
540, Platform/Chassis, 8x4/4	09.13 -					
540, Platform/Chassis, 8x6/4	09.13 -					
540, Truck Tractor, 4x2	09.13 -					
540, Truck Tractor, 4x4	09.13 -					
540, Truck Tractor, 6x2	09.13 -					
540, Truck Tractor, 6x2/4	09.13 -					
540, Truck Tractor, 6x4	09.13 -					
540, Truck Tractor, 6x6	09.13 -					
540, Truck Tractor, 8x4/4	09.13 -					
540, Dump Truck, 8x4	06.16 -					
540, Platform/Chassis, 6x6	06.16 -					
540, Platform/Chassis, 8x2	06.16 -					
540, Platform/Chassis, 8x4	06.16 -					
540, 43t, Platform/Chassis	06.16 -					
540, Truck Tractor, 4x2	06.16 -					
540, Truck Tractor, 8x4	06.16 -					

G - Serie









G 88 6x2 LHD				3870.30.00	380 10 380/210GSZ	- From chassis no.: 33995 - To chassis no.: 46790 - Loose clutch disc - GBox: R61, SR61
				8901.40.00	KZI - 5	- From chassis no.: 33995 - To chassis no.: 46790 - GBox: R61, SR61
				3892.20.00	380 GF2/380	- From chassis no.: 33995 - To chassis no.: 46790 - GBox: R61, SR61
				3848.50.00	380 GF2/380	- From chassis no.: 33995 - To chassis no.: 46790 - GBox: R61, SR61
				3871.30.00	380 10 380/70GSZ	- From chassis no.: 33995 - To chassis no.: 46790 - GBox: R61, SR61
				3515.10.00	350 GF2/350	- From chassis no.: 46791 - For: 6x2, 6x4 RHD - This part number includes one clutch disc
				3515.20.00	350 GF2/350	- From chassis no.: 46791 - For: 6x2, 6x4 RHD
G 88 6x2,6x4 RHD				3892.20.00	380 GF2/380	- From chassis no.: 33995 - To chassis no.: 40395 - From chassis no.: 42121 - To chassis no.: 46790
G 89				4200.90.71	420 10	
				4203.20.00	G420KR	
				4254.30.00	420GSZ	
				8900.40.00	KZI - 5	
				3892.20.00	380 GF2/380	

Vehicle list





					
---	---	---	--	---	---

VOLVO















G - Serie

G 88			 8901.40.00	KZI - 5	- Engine code: TD 100 A - GBox: MR61
			 3892.20.00	380 GF2/380	- Engine code: TD 100 A - GBox: MR61
			 3871.30.00	380 10 380/70GSZ	- Engine code: TD 100 A - GBox: MR61
			 4200.90.71  4203.20.00  4254.30.00  8900.40.00	420 10 G420KR 420GSZ KZI - 5	- Engine code: T 100A, B ;TD 100A - GBox: R 61, SR 61
			 3835.30.00	380 10 380GTZ	- Engine code: TD 100 A - GBox: MR61 - Loose clutch disc







N 7 01.70 - 09.80

Mot. TD 70	01.73 -		 7802.40.00	KZA - 4	
			 3511.20.00	350 G350KR	- GBox: R51, 52, R52B - This part number includes one clutch disc
			 5902.40.00	KZA - 4	- GBox: R51, 52, R52B
			 3515.20.00	350 GF2/350	







N 10

Mot. TD 100 Volvo KF215B, Volvo KF116, Volvo KF214E	01.73 - 12.83		 4200.90.71  4203.20.00  4254.30.00  8900.40.00	420 10 G420KR 420GSZ KZI - 5	- GBox: R/SR61
			 3515.20.00	350 GF2/350	- GBox: R/SR61
			 3892.20.00	380 GF2/380	- GBox: MR61
Mot. TD 100 Volvo KF215L	01.73 -		 3890.10.00	380 GF2/380	- GBox: MR62 - Loose clutch disc
Mot. TD 100, 101, 102 Volvo KF116B, Volvo KF214F, H	01.73 -		 3515.20.00	350 GF2/350	
Mot. TD 100, 101, 102 Volvo KF215K	01.77 -		 3848.50.00	380 GF2/380	- GBox: MR62B
Mot. TD 101, 102 Volvo KFD117B,C	01.80 -		 4300.90.21 	430 10 MFZ430 430WGTZ	- GBox: R/SR1400, 1700
			 4332.60.00  4323.30.00		
Mot. TD 101, 102 Volvo KFD214A	01.86 -		 3527.30.00	350 10 350GSZ	- GBox: R/SR1400, 1700
			 3588.30.00	350 10 350GSZ	- GBox: R/SR1400, 1700

N 12 01.70 - 09.86







Mot. TD 120 Volvo KF215B	01.73 - 12.83		 3892.20.00	380 GF2/380	- GBox: R/SR61, MR61B
			 3849.20.00	380 G380KR	
Mot. TD 120, 121, 122	01.73 -		 3890.10.00	380 GF2/380	- GBox: R/SR62 - GBox: R/SR70 - This part number includes one clutch disc
Mot. TD 120, 121 Volvo KF215K	01.73 -		 3849.20.00	380 G380KR	- GBox: MR62B
			 3808.30.00	380 10 380GSZ	- GBox: MR62B
			 3839.30.00	380 10 380GSZ	- GBox: MR62B
			 8901.40.00	KZI - 5	- GBox: MR62B

Vehicle list





					
---	---	---	--	---	---

VOLVO







N 12 01.70 - 09.86

Mot. TD 121, 122 Volvo KF215D,G	01.83 -		 38104.30.00	380 10 380GTZ	- GBox: R/SR70,71
			 38105.30.00	380 10 380GTZ	- GBox: R/SR70,71
			 8901.40.00	KZI - 5	- GBox: R/SR70,71
			 38101.30.00	380 10 380GVZ	- GBox: R/SR70,71 - Loose clutch disc
			 38102.30.00	380 10 380GVZ	- GBox: R/SR70,71
Mot. TD 121, 122 Volvo KFD214A, Volvo KFD215A	01.86 -		 3527.30.00	350 10 350GSZ	- GBox: R/SR1400, 1700
			 3588.30.00	350 10 350GSZ	- GBox: R/SR1400, 1700



















N 88

N 88			 4200.90.71	420 10	
			 4203.20.00	G420KR	
			 4254.30.00	420GSZ	
			 8900.40.00	KZI - 5	







NB - Serie

NB 86 über 32 t Gesamtgewicht			 3511.10.00	350 GF2/350	
NB 88			 4200.90.71	420 10	
			 4203.20.00	G420KR	
			 4254.30.00	420GSZ	
			 8900.40.00	KZI - 5	
NB 86 bis 32 t Gesamtgewicht			 3803.20.00	380 G380KR	- Engine code: TD 70
			 7802.40.00	KZA - 4	- Engine code: TD 70

NH 12 01.98 -



NH 12 8x4 NH 12/380, 26t, Platform/Chassis, 6x4 NH 12/380, 17t, Truck Tractor, 4x2 NH 12/380, 26t, Truck Tractor, 6x4 NH 12/420, 17t, Truck Tractor, 4x2	05.99 - 05.99 - 05.99 - 05.99 -	D12C380 D12C420	 4000.90.08 ⊕	400 24	- Vehicles with double disc clutch
			 4027.10.00	MFZ2/400X	
			 4032.30.00	400WGTZ	
			 4300.90.33 ⊕	430 10	
			 4332.60.00	MFZ430	
			 4331.30.00	430WGTZ	
			 4300.90.62 ⊕	430 24	- Engine code: VT2412B
			 4336.60.00	MFZ430	
			 4329.30.00	430WGTZ.	
			 4300.90.63 ⊕	430 24	- Engine code: VT2412B
			 4385.60.00	MFZ430	
			 4389.30.00	430WGTZ	
			 4300.90.35 ⊕	430 24	- GBox: VT2214B/VTO2214B, VT2514B/VTO2514B
			 4333.60.00	MFZ430	
			 4325.30.00	430WGTZ	
 4300.90.64 ⊕	430 24	- GBox: VT2214B/VTO2214B, VT2514B/VTO2514B			
 4383.60.00	MFZ430				
 4389.30.00	430WGTZ				
 4047.10.00	400 MFZ2/400X	- Vehicles with double disc clutch - This part number includes one clutch disc			
4300.90.128	430 24	- Transmission type: VT2214B/VTO2214B, VT2514B/VTO2514B			
4383.60.00	MFZ430				
4389.30.00	430WGTZ				

Vehicle list

					
---	---	---	--	---	---

VOLVO

NL 10 S



Mot. TD 101, 102, 103	01.91 -		 4300.90.21 ⊕	430 10	- GBox: R/SR1400, 1700
			 4332.60.00	MFZ430	
			 4323.30.00	430WGTZ	

V..



VM 260 4x2			 3955.30.00	395 10	
				395WGTZ	

VOLVO (TÜRKİYE)



F88 - G88

F88 - G88 CIFT CEKER			 3892.20.00	380	
				GF2/380	
			 3530.30.00	350 10	
				350GSZ	
			 3531.30.00	350 10	
				350GSZ	



F10 - F12 - N10 - N12

F10... CIFT CEKER			 3515.20.00	350	
				GF2/350	
			 3527.30.00	350 10	
				350GSZ	
			 3528.30.00	350 10	
				350GSZ	



F10 - F12 - N10 - N12

F12...CIFT CEKER			 38102.30.00	380 10	
				380GVZ	
			 38101.30.00	380 10	
				380GVZ	



FH12 - FH16 - FM12

FH12 - FH16 - FM12			 4027.60.00 ⊕	400	
				MFZ2/400X	
			 4033.30.00	400 10	
				400WGTZ	
			 4031.30.00	400 8	
				400GTZ	





FH12 - FM12

FH12 - FM12			 4027.60.00 ⊕	400	
				MFZ2/400X	
			 4031.30.00	400 8	
				400GTZ	
			 4032.30.00	400 24	
				400WGTZ	







F10 - N10

F10 - N10			 4257.20.00	420	
				GMF420K	
			 4212.30.00	420 10	
				420/210GSZ	

F12 - FH12 - FL12 - FM12







F12 - FH12 - FL12 - FM12			 4300.90.33 ⊕	430 10	
				MFZ430	
			 4332.60.00	430WGTZ	
			 4331.30.00		
			 4332.60.00 ⊕	430	
				MFZ430	
			 4331.30.00	430 10	
				430WGTZ	

Vehicle list

					
---	---	---	--	---	---





VOLVO (TÜRKİYE)

FH12 - FM12

FH12 - FM12			 4300.90.35 ⊕	430 24	
			 4333.60.00	MFZ430	
			 4325.30.00	430WGTZ	
			 4333.60.00 ⊕	430	
				MFZ430	
			 4325.30.00	430 24	
				430WGTZ	
			 8931.40.00	KZISZ-5	



YAMZ

LKW



LKW			 3607.20.00	362	- GBox: ZF 6S-850
				MF362	
			 3611.30.00	362 10	- GBox: ZF 6S-850
				362GTZ	
			 4301.20.00	430	- GBox: ZF 6S-850
				MFZ430	
			 4305.30.00	430 10	- GBox: ZF 6S-850
				430W2GTZ	

ZASTAVA

Zastava 1500



Z 1500, 1500cc Z 1500 TF Z 1500 TR Z 1500 K Z 1500 FI Z 1500 Sanitet			 2001.20.00	200	
				KF 200	
			 2002.30.00	200 20	
				200CE	

Zastava 412

Z 412 Z 412 N Z 412 NE Z 412 TR Z 412 NK Z 412 FI Z 412 Sanitet			 2001.20.00	200	
				KF 200	
			 2002.30.00	200 20	
				200CE	



Zastava Daily

00.78 -

28 F8 32 F8 35 F8 40 F8	00.78 - 00.78 - 00.78 - 00.78 -		 2402.20.00	240	
				MF240	
			 2402.30.00	240 10	
				240PSD	

Zastava 30...40.8

10.78 -



30 U-8 32 U-8 32 U-8S 35 U-8 35 U-8S 40 U-8 40 U-8H 28-8 30-8, A 32-8 35-8, A 40-8, A	10.78 - 10.78 - 12.80 10.78 - 12.80 10.78 - 09.80 - 10.78 - 09.80 - 01.81 - 09.84 - 01.81 - 10.81 - 10.81 -		 2402.20.00	240	
				MF240	
			 2402.30.00	240 10	
				240PSD	

Vehicle list



					
---	---	---	--	---	---

ZASTAVA



Zastava Daily 02.90 -

35.8	02.90 -		2353.20.00	235 MFZ235	
35.10	02.90 -				
40.8	02.90 -		2354.30.00	235 10 235CBL	
45.10	08.90 -				
49.10 Turbo	08.90 -				



Zastava 617/619

Z 617 N			2514.20.00	250 H250K	
Z 617 K					
Z 619 N			2514.30.00	250 10 250CBL	
Z 619 K					
Z 624 N			5800.40.00	KZA - 2	
Z 624 K					
Z 630 N					
Z 630 K					
Z 630 N, I, L, A					



Zastava 35.8...50.8

Z 35.8 N,D,K			2514.20.00	250 H250K	
Z 35.8 NF,DF,KF					
Z 50.8 N,D,K			2514.30.00	250 10 250CBL	
Z 50.8 NF,DF,KF			6300.40.00	KZI - 2	

Zastava 635/640



Z 635 N, D, A			2810.20.00	280 H280K	
Z 640 N, D, A					
Z 645 N, D, A			2810.30.00	280 10 280CBL	
Z 650 N, D, A			6200.40.00	KZ - 4	

Zastava Turbozeta

Z 70.10 N, D			3169.20.00	310 MF310	
Z 80.10 N, D, K					
Z 83.10 N, NF, D, DF, K			3113.30.00	310 10 310GSBL	
			8508.40.00	KZI - 4,5	

ZIL

LKW

LKW			4301.20.00	430 MFZ430	
			8916.40.00	KZIZ - 5	

Arithmetical list

Reference	Parameter	Hub profile	Manufacturer	Page
1800.90.02			BARKAS	6
1801.20.00	T180120		BARKAS	6
1801.30.00	180DE2R	18,27X20,7-24Z	BARKAS	6
2000.90.19			RENAULT	470 471
2000.90.36			RENAULT	470 471
2000.90.40			RENAULT	471 472
2001.20.00	KF 200		ZASTAVA	634
2002.30.00	200CE	20,1X23,07-20Z	ZASTAVA	634
2013.30.00	200S	23x29x4	DEMAG	41
2023.20.00	DB200		RENAULT	470 471
2034.30.00	200CE	20X21,91-26Z	RENAULT	470 471
2042.20.00	CP20		RENAULT	470 471 472
2045.30.00	200D	21,38X24,14-21Z	RENAULT	470 471
2080.30.00	200VTB	21,4x24,3-21N	RENAULT	471 472
2150.90.03			MERCEDES-BENZ	351
2150.90.07			RENAULT	470
2150.90.10			FORD	45 46
2150.90.16			PEUGEOT	469
2150.90.18			FIAT	45
			PEUGEOT	469
2150.90.26			MERCEDES-BENZ	348 349 350 351
2150.90.42			RENAULT	470 471
2157.30.00	215PSD	29X23X4-10	MERCEDES-BENZ	348 349 350 351
2171.20.00	MF215K		FORD	45 46
2172.30.00	215D	23,49X26,01-23Z	FORD	45 46
2173.20.00	M215		MERCEDES-BENZ	348 349 350 351 363
2178.30.00	215CE	21,4X24,1-21Z	FIAT	45
			PEUGEOT	469
			RENAULT	470 471
2185.20.00	CP215		FIAT	45
			PEUGEOT	469 470
			RENAULT	470 471
2198.30.00	215CE	23,7X25,8-23Z	PEUGEOT	469 470
2256.30.00	225Z	26x32x4-10N	DEMAG	41
2260.20.00	KS225		DEMAG	41
2260.30.00	225BHZ	26X32X4-10	MERCEDES-BENZ	356
2262.20.00	KS225		FAUN	42
			MERCEDES-BENZ	356
2280.90.02			MERCEDES-BENZ	348 349 350 351 352 366 367
2280.90.03			MERCEDES-BENZ	349 350 351 352 353 366 367 368
2280.90.04			MERCEDES-BENZ	348 350 367 368
2281.30.00	228PSD	23X29-10Z	MERCEDES-BENZ	348 349 350 351 352 366 367 368
2282.20.00	M228KR		MERCEDES-BENZ	348 349 350 351 352 366 367 368

Arithmetical list

Reference	Parameter	Hub profile	Manufacturer	Page		
2283.20.00	M228KR		MERCEDES-BENZ	349 352 365 368	350 353 366 369	351 363 367
2306.30.00	228GSB	23X4X27-10Z	MERCEDES-BENZ	349 352 366	350 353 367	351 363 368
2307.30.00	228CB	23X4X29-10Z	MERCEDES-BENZ	348 351 367	349 352 368	350 366 369
2350.90.01			IVECO	48 51 54	49 52 55	50 53 56
2353.20.00	MFZ235		IVECO	48 51 54	49 52 55	50 53 56
			ZASTAVA	635		
2354.30.00	235CBL	23X29-10Z	IVECO	48 51 54	49 52 55	50 53 56
			ZASTAVA	635		
2400.20.00	MF240		STEYR	571		
2400.30.00	240PSD	23X29X-10Z	STEYR	571		
2400.90.01			IVECO	48	49	52
2400.90.05			MERCEDES-BENZ	461		
2400.90.06			DAF	40		
			FORD	45	46	47
2402.20.00	MF240		DAF	40		
			IVECO	48	49	52
			ZASTAVA	634		
2402.30.00	240PSD	23X29X-10Z	IVECO	48	49	52
			ZASTAVA	634		
2403.20.00	MF240		DAF	40		
			FORD	45	46	47
2413.30.00	240TD	23X26-23Z	DAF	40		
			FORD	45	46	47
2418.30.00	240CTB	26x29-26N	MERCEDES-BENZ	461	462	463
2500.90.01			MERCEDES-BENZ	367 371	369 372	370
2504.30.00	250CBL	1 1/4" SAE 10C	OTOYOL (TÜRKİYE)	468		
2507.20.00	HBX250		FAUN	41		
			MERCEDES-BENZ	366 369 372	367 370	368 371
2510.30.00	250Z	26x32-10	LIEBHERR	131	132	
2511.30.00	250Z	A26X30X4-10N	DEMAG	41		
2514.20.00	H250K		IVECO	112	125	407
			IVECO	57	88	
			OTOYOL (TÜRKİYE)	468		
			ZASTAVA	635		
2514.30.00	250CBL	1 1/4"-10Z	IVECO	112 407	121	125
			IVECO	57	88	
			ZASTAVA	635		
2517.20.00	G250K		FAUN	42		
2517.30.00	250	1 1/8"-10Z	KRUPP	131		

Arithmetical list

Reference	Parameter	Hub profile	Manufacturer	Page	
2518.20.00	G250		DEMAG	41	
			LIEBHERR	131 132	
			MAGIRUS-DEUTZ	133	
2518.30.00	250GSZ	26X32-10Z	FAUN	42	
			LIEBHERR	132	
			MAGIRUS-DEUTZ	133	
			MERCEDES-BENZ	358	
2520.20.00	G250		MERCEDES-BENZ	358	
2520.30.00	250CB	29x35-10N	RENAULT TRUCKS	486	
2521.20.00	G250		KRUPP	131	
2525.20.00	MF250		RENAULT TRUCKS	473 486 509	
			RENAULT TRUCKS	525 527 529	
2528.30.00	250BHZX	26X32-10Z	FAUN	41	
			MERCEDES-BENZ	366 367 368	
				369 370 371	
2530.20.00	G250		MERCEDES-BENZ	355 356 357	
2538.30.00	250TPZ	26x32-10N	MERCEDES-BENZ	355 356 357	
2548.30.00	250CD	26,5x28,9-26N	MERCEDES-BENZ	357	
2650.90.01			IVECO	48 49 50	
				51 52 53	
2650.90.15			IVECO	48 50 51	
				52 53 54	
2651.20.00	MF265		IVECO	48 49 50	
2654.20.00	MF270		IVECO	112 114	
			IVECO	57	
2655.30.00	*	265TB	23x29-10N	IVECO	48 49 50
					51 52 53
2656.30.00	*	270CTB	26x32-10N	IVECO	112 114
				IVECO	57
2658.20.00	MFZ265		IVECO	48 50 51	
				52 53 54	
				57	
2665.30.00	*	260 CTD	26X29-26N	MERCEDES-BENZ	461 462 463
2678.30.00	*	265VTP	23x29-10N	IVECO	48 50 51
					52 53 54
					55 56 57
2800.90.01			MERCEDES-BENZ	353 354 355	
				370 372	
2800.90.31			IVECO	50 51 52	
				53 54 55	
				56	
2800.90.32			IVECO	54 55 56	
2801.20.00	G280		MAN	253	
			TAM	581	
2802.20.00	G280		IVECO	96	
			LIEBHERR	132	
			MAGIRUS-DEUTZ	132 133	
			MAN	252 253 254	
			TAM	580 581	
2802.30.00	280BHZ	32X40-10	TAM	581	
2803.20.00	G280		TAM	581	
2803.30.00	280BHZ	26X32-6	TAM	580 581	

Arithmetical list

Reference	Parameter	Hub profile	Manufacturer	Page
2805.30.00	280BHZ	26X32-10	FAUN	41
			MERCEDES-BENZ	355 356 357 358
2808.20.00	G280		MERCEDES-BENZ	355 356 357 358
2809.20.00	H280		IVECO	113 406 407
2810.20.00	H280K		IVECO	113 115 406 407 408
			IVECO	56 57 88
			MAGIRUS-DEUTZ	134
			ZASTAVA	635
2810.30.00	280CBL	1 3/8"-10Z	IVECO	113 115 406 407 408
			IVECO	56 57 88
			MAGIRUS-DEUTZ	134
			ZASTAVA	635
2812.20.00	HVB280		FAUN	41
			MERCEDES-BENZ	353 363 364 371 372 375 376 378 380 381
2812.30.00	280Z	28X35X4-10	MERCEDES-BENZ	363 364 371 376
2813.20.00	HVB280		MERCEDES-BENZ	390
2819.30.00	280GSZ	26X32-10Z	MAGIRUS-DEUTZ	134
2820.20.00	MF280		IVECO	70 86
			MAGIRUS-DEUTZ	133
2821.20.00	MF280K		TAM	581
2821.30.00	280GTZ	32X40-10	TAM	581
2822.20.00	MF280		RENAULT TRUCKS	509 525 530
2822.30.00	280GTZ	28X35-10Z	MERCEDES-BENZ	348 353 354 355 364 370 371 372 373 374 375 376 377 378 379 380 381 390
2823.20.00	MF280		MERCEDES-BENZ	348
2826.20.00	MF280		MERCEDES-BENZ	370 372
2827.30.00	280Z	32X40-10Z	MAN	253 254
2832.30.00	280GTZ	1 3/8"-10Z	IVECO	70 86
			MAGIRUS-DEUTZ	133
2835.20.00	MFZ280		MAN	186
2837.20.00	MFZ280		MERCEDES-BENZ	353 354 355 370 372
2841.20.00	G280		KRUPP	131
			MERCEDES-BENZ	355
2844.30.00	280Z	1 1/2"-10N	KRUPP	131
2845.20.00	HVB280		MERCEDES-BENZ	353 370 372 373 374 377 378 379
2858.30.00	280GTZ	1 1/2"-10N	IVECO	61 71
2861.20.00	MFZ280		IVECO	50 51 52 53 54 55 56
2867.30.00	* 280 VBL	23x30,55x10N	IVECO	50 51 52 53 54 55 56
2953.20.00	GF295		MERCEDES-BENZ	353 375 376 378 380 382 387 390 408

Arithmetical list

Reference	Parameter	Hub profile	Manufacturer	Page		
2954.30.00	295BHZ	28X35-10Z	MERCEDES-BENZ	353	375	376
				378	380	382
				387	390	408
2955.20.00	GF295		IVECO	116		
			MAGIRUS-DEUTZ	134	135	136
3100.90.01			RENAULT TRUCKS	486	509	510
3100.90.02			MERCEDES-BENZ	513	530	
				353	354	355
3100.90.03			IVECO	57	58	59
				60	71	
			RENAULT TRUCKS	509	510	512
3100.90.12			MERCEDES-BENZ	513	515	
				375	377	378
3100.90.13			MERCEDES-BENZ	380	383	388
				390	396	397
				408		
3101.20.00	GFX310		IVECO	112	113	114
				116		
3101.30.00	310GSZ	28x35x10	MERCEDES-BENZ	373	374	376
				377	379	382
				387	395	408
3102.20.00	GF310K		STEYR	578		
3102.30.00	310GSZ	32X40-10	TAM	581		
3107.20.00	GF310K		TAM	580	581	
3108.30.00	310GSZ	10	DAF	7	9	19
			TAM	580		
3113.30.00	310GSZ	10	MAGIRUS-DEUTZ	134		
			MAGIRUS-DEUTZ	135		
			MAN	253		
3117.30.00	310GSBL	1 1/2"-10Z	IVECO	112	113	114
				115	116	
			IVECO	71	87	
			MAGIRUS-DEUTZ	135	136	
			MAN	256	259	
			OTOYOL (TÜRKİYE)	469		
			RENAULT TRUCKS	486	509	510
				513	530	531
3119.20.00	GFX310		ZASTAVA	635		
3117.30.00	310GSZ	26X32-10Z	MERCEDES-BENZ	355	356	357
3119.20.00	GFX310		MERCEDES-BENZ	358		
				378	380	382
3120.20.00	GFX310		EVOBUS	41		
			MERCEDES-BENZ	373	374	382
3122.20.00	GFX310		MERCEDES-BENZ	386	387	395
				408		
				376	377	380
3124.30.00	310GSBL	28X35-10Z	MERCEDES-BENZ	382	386	387
				408		
				370	372	373
3125.20.00	GFX310		MERCEDES-BENZ	374	376	377
				378	379	380
				382	386	387
				390	395	397
				408		
3126.20.00	GF310X		MAN	253	254	255
				258		

Arithmetical list

Reference	Parameter	Hub profile	Manufacturer	Page	
3126.30.00	310GSBL	28X35-10Z	EVOBUS	41	
			MERCEDES-BENZ	348 353 354	
				355 371 373	
				374 376 378	
				379 380 382	
				383 386 387	
				390 391 395	
397 398 408					
3127.30.00	310GSBL	1 1/2"-10C	MAN	192 193 194 195	
3130.20.00	G310K		FAUN	42	
3130.30.00	310W2GSZ	32X40-10Z	TAM	580	
3131.20.00	G310		FAUN	42	
			KRAUSS-MAFFEI AG	130	
			KRUPP	130 131	
			MAGIRUS-DEUTZ	134	
			MAGIRUS-DEUTZ	135	
			MAN	253	
			STEYR	578	
3132.30.00	310GSB	1 1/2"-10Z	IVECO	57 58 59 60 71	
			RENAULT TRUCKS	509 510 512	
				513 515	
3133.20.00	G310		MAN	252 253	
3133.30.00	310GSBL	1 1/2"- 10N	OTOYOL (TÜRKİYE)	469	
3136.30.00	310WGSZ	28X35-10	MERCEDES-BENZ	353 354 371	
				372 374 375	
				377 378 380	
				383 388 390	
				396 397 408	
3140.30.00	310W2GSZ	1 1/2"-10Z	MAGIRUS-DEUTZ	135	
3155.30.00	310Z	32X40-10	KRAUSS-MAFFEI AG	130	
			KRUPP	130 131	
			MAN	253 254 255	
				258	
3158.20.00	MF310		VOLVO	606	
3160.20.00	MF310		DAF	8 9 11	
3161.20.00	MF310		MERCEDES-BENZ	355 356 357 358	
3162.20.00	MF310		IVECO	115	
			MAGIRUS-DEUTZ	135	
			RENAULT (TÜRKİYE)	472	
3162.30.00	310GTD	1 1/2: -10N	RENAULT (TÜRKİYE)	472	
3163.30.00	310GTD	1 1/2"	STEYR	573 574 575 576	
3164.20.00	MF310		MERCEDES-BENZ	348 370 371	
				372 374 375	
				377 378 379	
				380 382 383	
				388 390 391	
				396 397 398	
				408	
				TAM	580
				IVECO	87 115
			MAGIRUS-DEUTZ		136
3166.20.00	MF310		IVECO	87 115	
3168.20.00	MF310		MAN	192 193 194	
				195 256 259	

Arithmetical list

Reference	Parameter	Hub profile	Manufacturer	Page		
3169.20.00	MF310		IVECO	112	113	114
				116		
			IVECO	71	87	
			OTOYOL (TÜRKİYE)	469		
			RENAULT TRUCKS	486	509	510
			ZASTAVA	513	530	
				635		
3173.20.00	MF310		RENAULT TRUCKS	530	531	
3176.20.00	MFZ310		MERCEDES-BENZ	353	354	355
				371	373	374
3179.20.00	MFZ310		IVECO	57	58	59
				60	71	
			RENAULT TRUCKS	509	510	512
				513	515	
3180.20.00	GMFZ310KR		MAN	186		
3184.20.00	MFZ310		MAN	186		
3189.20.00	MFZ 310		OTOYOL (TÜRKİYE)	469		
3203.40.00	KZIS - 1		MERCEDES-BENZ	351		
3205.40.00	KZIS - 0		DAF	40		
			FORD	45	46	47
				48		
3206.40.00	KZIS - 1		FORD	45	46	
3211.40.00	KZIS - 0		FIAT	45		
			PEUGEOT	469		
3212.40.00	KZI - 0		BARKAS	6		
3214.40.00	KZI/T - 1		MERCEDES-BENZ	348	349	350
				351	352	353
				363	365	366
				367	368	369
3216.40.00	KZAS - 0		RENAULT	470	471	472
3224.40.00	KZAS - 00		RENAULT	470	471	
3233.40.00	KZAS - 0B		RENAULT	470		
			RENAULT TRUCKS	473	509	
3258.30.00	325GSZ	1 3/8" SAE 10C	FORD (TÜRKİYE)	48		
3259.30.00	13" 325GS	1 1/2" SAE 10C	BMC (TÜRKİYE)	6	7	
3300.20.00	GFM330		MAGIRUS-DEUTZ	137		
			MERCEDES-BENZ	356	358	359
				360	375	377
				379	380	383
				388	389	391
				397	398	
3300.30.00	330GSZ	28X35-10	MERCEDES-BENZ	379	383	388
				391	397	398
3300.90.01			IVECO	58	59	60
				67	71	
3300.90.04			MERCEDES-BENZ	375	377	380
				388	389	
3300.90.08			MAN	187	188	189
				191	192	193
				194	195	199
				200	201	
			STEYR	572	573	574
				575	576	
3305.20.00	GMF330		MERCEDES (TÜRKİYE)	280		
			MERCEDES-BENZ	375	378	381
				383	388	389
				396		

Arithmetical list

Reference	Parameter	Hub profile	Manufacturer	Page
3309.30.00	330GSZ	1 1/2"-10	MAN	187 188 189
				191 192 193
				194 195 199
				200 201
			STEYR	572 573 574
				575 576
3310.30.00	330GSZ	36X40-20Z	MERCEDES-BENZ	358 359 360
3312.20.00	MFZ330		IVECO	58 59 60
				67 71
3313.20.00	MFZ330		MAN	187 188 189
				191 192 193
				194 195 199
				200 201
			STEYR	572 573 574
				575 576
3315.30.00	330GS	1 1/2"-10Z	IVECO	58 59 60
				67 71
3321.30.00	330GSB	35x40-20Z	MERCEDES-BENZ	358 359 360
3325.30.00	330WGSZ	28X35-10Z	MERCEDES (TÜRKİYE)	280
			MERCEDES-BENZ	375 377 378
				380 381 383
				388 389 396
3328.30.00	330WGSZ	1 1/2"-10N	MAGIRUS-DEUTZ	137
3500.90.01			VOLVO	582 585
3500.90.03			VOLVO	583
3500.90.04			MAN	190 191 192
				193 194 195
				196 197 198
				199 254
			MERCEDES-BENZ	381 382
			STEYR	573 574
3500.90.05			DAF	8 9 10
3500.90.11			MERCEDES-BENZ	388 389 390
				391 392 398
				399 405 406
				409 428
3500.90.13			MERCEDES-BENZ	390 391 404
				405
3500.90.39			DAF	10 12
3500.90.42			RENAULT TRUCKS	483 485 486
				506 509 510
				511 513 514
				515 530
3500.90.43			RENAULT TRUCKS	512
3500.90.51			VOLVO	585 587
3500.90.53			DAF	20
3502.20.00	G350KR		MERCEDES-BENZ	408
			TAM	581
3502.30.00	350GSZ	32X40-10Z	MERCEDES-BENZ	365 383 388
				389 391 393
				396 398 399
				408 409 423
			TAM	425 581
3505.20.00	G350KR		FAUN	42 43 44
			MAGIRUS-DEUTZ	133
			MAGIRUS-DEUTZ	134 135 136
				137 141 145
				409
			MERCEDES-BENZ	363 389
3506.20.00	G350		KRAUSS-MAFFEI AG	130
			MERCEDES-BENZ	364 365
			STEYR	578 579

Arithmetical list

Reference	Parameter	Hub profile	Manufacturer	Page
3510.30.00	350W2GSZ	1 3/4"-10Z	MAN	254 255 256
				257 258 259
				260 262 263
			RENAULT TRUCKS	264 266
				525
35101.30.00	350WGTZ	1 3/4"	DAF	20
3511.10.00	GF2/350		VOLVO	582 585 632
3511.20.00	G350KR		VOLVO	582 631
3512.30.00	350W2GSZ	32X40-10Z	FAUN	43
			MAGIRUS-DEUTZ	134
			MAGIRUS-DEUTZ	136 137 141
			145	
3514.30.00	350WGSZ	36X45-10Z	MAN	252
3515.10.00	GF2/350		VOLVO	582 585 586
				587 630
3515.20.00	GF2/350		VOLVO	582 583 586
				587 630 631
			VOLVO (TÜRKİYE)	633
3515.50.00	GF2-350		VOLVO	582 585 587
3516.10.00	GF2/350		VOLVO	583 585 587
3516.20.00	G350KR		VOLVO	585
3516.30.00	350WGSZ	32X40-10	MAN	252 254 256
				258 259 262
				266
			ÖSTERREICHISCHE AUTOMOBILFABRIK (ÖAF)	463 464 465
			RENAULT TRUCKS	526
			STEYR	578
3517.30.00	350WGSZ	1 3/4"-10Z	MERCEDES-BENZ	375 381 388
				390 391 392
				396 398 399
				404 405 423
35173.20.00	MF350		DAF	20
3519.30.00	350GSZ	32X40-10Z	MAGIRUS-DEUTZ	133
			MAGIRUS-DEUTZ	134 135 136
				137 138 409
3520.20.00	GF350KR		MAN	259
3521.20.00	GF350KR		DAF	7 8 9
				10 11 12
				19
			MAN	252 254 256
				258 262 265
				266
			MERCEDES-BENZ	391 393 396
				398 400 412
				413
			ÖSTERREICHISCHE AUTOMOBILFABRIK (ÖAF)	463 464 465
			RENAULT TRUCKS	526
3522.20.00	GF350KR		MERCEDES-BENZ	364 365 383
				388 389 391
				396 398 399
				408 409 425
3522.30.00	350GSZ	1 3/4"-10Z	MERCEDES-BENZ	398 423
3524.20.00	GF350KR		DAF (TÜRKİYE)	40
3527.30.00	350GSZ	2"-10Z	VOLVO	604 631 632
			VOLVO (TÜRKİYE)	633
3528.30.00	350GSZ	2"-10Z	VOLVO (TÜRKİYE)	633
3529.20.00	GF350KR		STEYR	578 579
3530.30.00	350GSZ	1 3/4"-10Z	MAN	258 259 262
			VOLVO	585 587
			VOLVO (TÜRKİYE)	633

Arithmetical list

Reference	Parameter	Hub profile	Manufacturer	Page
3531.30.00	350GSZ	1 3/4" SAE 10C	VOLVO (TÜRKİYE)	633
3536.20.00	GF350K		IVECO	93
			MAN	260
3539.20.00	GF350		MAN	254 255 256 257 258 259 260 263 264 266
3540.20.00	LA350		TAM	581
3552.30.00	350	32X40-10Z	KAELBLE	126
			KRAUSS-MAFFEI AG	130
			MAN	252
			MERCEDES-BENZ	363 364 365 396 400 412 413
			TAM	581
3559.30.00	350GSZ	1 3/4"-10Z	VOLVO	582
3561.30.00	350GSZ	2"-10Z	VOLVO	583
3562.20.00	GMF350		RENAULT TRUCKS	525
3562.30.00	350GSZ	1 3/4"-10Z	VOLVO	585 587
3563.20.00	GMF350		DAF	8 9 10 11 13
			IVECO	71 94 116 117
			MAGIRUS-DEUTZ	134 135 136 137 138 140 143
			MAN	254 255 256 257 258 262 263 266
			MERCEDES-BENZ	358 359 360
			RENAULT TRUCKS	485 525
3563.30.00	350GSZ	1 1/2"-10Z	DAF	7 8 9 10 11 19
			DAF (TÜRKİYE)	40
			MAGIRUS-DEUTZ	136
			MAN	186 257 259 262
3564.30.00	350GSZ	1 3/4"-10Z	DAF	9 10 12 21
			MAGIRUS-DEUTZ	134 135 137 138 140 143
			MERCEDES-BENZ	379
3565.20.00	GMF350		DAF	8 9 10 11 13
			MAGIRUS-DEUTZ	136
			MAN	254 255 256 257 258 259 262
			MERCEDES (TÜRKİYE)	280
			RENAULT TRUCKS	525
3566.20.00	GMF350		MERCEDES-BENZ	359 360
3568.30.00	14" 350GSZ	1 3/4" SAE 10C	BMC (TÜRKİYE)	6 7
3569.30.00	14" 350GSZ	1 3/4 SAE 10C	BMC (TÜRKİYE)	6 7
3570.20.00	GMF350		IVECO	71 86 87 88 94 115 116 117
			MAGIRUS-DEUTZ	136
3570.30.00	350Z	36X45-10Z	RENAULT TRUCKS	525
3571.30.00	350	1 1/2 -10	RENAULT TRUCKS	485

Arithmetical list

Reference	Parameter	Hub profile	Manufacturer	Page			
3573.20.00	MF350		DAF	8 9 10 12 19 21			
			MAGIRUS-DEUTZ	136			
			MAN	186 190 191 192 193 194 195 196 197 198 199 254 255 257 259 262			
			MERCEDES-BENZ	381 382			
			STEYR	573 574			
			3574.20.00	14" MF 350		BMC (TÜRKİYE)	6 7
						FORD (TÜRKİYE)	48
						RENAULT (TÜRKİYE)	472
						RENAULT TRUCKS	483 485 486 506 509 510 511 512 513 514 515 530
						3574.30.00	14" 350GSZ
FORD (TÜRKİYE)	48						
3575.30.00	350WGSZ	1 3/4"-10Z	MAN	254 255 256 257 258 259 260 262 263 264 266			
			RENAULT TRUCKS	525			
			3577.30.00	350WGSZ	1 3/4"	STEYR	573 574 575 576 578 579
						3578.30.00	14" 350GSZ
3580.20.00	GMF350		DAF	19			
			MERCEDES (TÜRKİYE)	280			
			MERCEDES-BENZ	375 379 381 384 388 389 390 391 392 396 398 399 404 405 406 409 419 423 428			
			3581.20.00	GMF350KR		DAF	9 10 12 19
						3583.20.00	GMF350
			3583.30.00	350GSZ	1 3/4"-10Z		
						IVECO	71 93 94 116 117
						LIEBHERR	132
MAGIRUS-DEUTZ	136						
MERCEDES-BENZ	381 384 385 388 389 390 391 392 396 398 399 405 406 409 419 423 428						
3585.30.00	350GSZ	1 1/2"-10Z				IVECO	71 86 87 88 94 115 116 117
						MAGIRUS-DEUTZ	136

Arithmetical list

Reference	Parameter	Hub profile	Manufacturer	Page			
3587.30.00	350GSZ	1 1/2"-10Z	MAN	190	191	192	
				193	194	195	
				196	197	198	
				199	254		
				MERCEDES-BENZ	381	382	
				RENAULT TRUCKS	481	483	485
					486	506	509
					510	511	513
					514	515	530
					531		
	STEYR	573	574				
3588.30.00	350GSZ	32X40-10	FAUN	41	42		
			MAN	252			
			ÖSTERREICHISCHE AUTOMOBILFABRIK (ÖAF)	468			
			STEYR	578			
			VOLVO	604	631	632	
3589.30.00	350GTZ	1 3/4"-10N	VOLVO	586			
3590.30.00	350GSZ	1 3/4"-10Z	VOLVO	582	585	586	
3591.30.00	350WGTZ	1 1/2"-10N	MAN	192			
			RENAULT TRUCKS	512	513	514	
3592.30.00	14" 350GSZ	1 3/4" SAE 10C	BMC (TÜRKİYE)	6			
3593.30.00	350 GSZ	1 1/2" SAE 10C	ASKAM CHRYSLER (TÜRKİYE)	1			
3594.30.00	14" 350GSZ	1 1/2" SAE 10C	BMC (TÜRKİYE)	6			
3596.30.00	350WGSZ	1 1/2"-10Z	MAN	190	191	192	
				255			
	RENAULT (TÜRKİYE)	472					
3597.30.00	350 WGTZ	1 3/4 SAE 10C	MERCEDES (TÜRKİYE)	280			
3599.30.00	350 GTZ	1 3/4" SAE 10C	MERCEDES (TÜRKİYE)	280			
3601.20.00	MF362		AVIA	6			
			MAN	187	188	190	
				191	200	203	
				227	228	229	
				230			
	MAN (TÜRKİYE)	278					
3606.20.00	MF362		MERCEDES (TÜRKİYE)	281			
			MERCEDES-BENZ	310	311	312	
				313	314	315	
				316	317	318	
				319	320	322	
				324	326	328	
				330	333	335	
				336	338	343	
				347	356	361	
				362	363	371	
				372	375	377	
				378	381	388	
				396			
3606.30.00	362WGTB	36x40-18N	MERCEDES-BENZ	356	361		
3607.20.00	MF362		DAF	20	21	22	
			IVECO	60	62	67	
				68	69		
			KAMAZ	127			
			YaMZ	634			

Arithmetical list

Reference	Parameter	Hub profile	Manufacturer	Page
3607.30.00	362WGTZ	1 1/2"-10C	DAF	20 21
			IVECO	62 67
			MAN	187 188 190
				191 200 203
				227 228 229
				230
			MAN (TÜRKİYE)	278
			MAZ	279
			RENAULT (TÜRKİYE)	472
			3608.20.00	MF362
MAZ	279			
RENAULT (TÜRKİYE)	472			
3608.30.00	362WGTZ	1 3/4"-10N	IVECO	60 68 69
			MAZ	279
3609.30.00	362 WGTZ	1 3/4"-10N	DAF	20 21
			IVECO	60 62 68 69
3610.20.00	MFZ362		MAN	151 187 188
				189 191 192
				194 195 199
				200 201 230
			232	
			MAN (TÜRKİYE)	278
STEYR	572 573 574			
	575 576			
3610.30.00	362GTZ	1 1/2"-10N	DAF	21 22
			MAN	151 187 188
				189 191 192
				194 195 199
				200 201 230
			232	
			MAN (TÜRKİYE)	278
			STEYR	572 573 574
575 576				
3611.30.00	362GTZ	1 3/4"-10N	DAF	21
			KAMAZ	127
			YaMZ	634
3612.30.00	362GTZ	1 1/2"-10N	KAMAZ	127
3613.30.00	362GTZ	1 1/2"-10	KAMAZ	127
3617.20.00	MF362		DAF	20
3617.30.00	362WGTZ	1 1/2"-10N	RENAULT TRUCKS	515 516
3619.30.00	362WGTZ	1 3/4"-10N	RENAULT TRUCKS	516
3620.20.00	MF362		RENAULT TRUCKS	515 516
3620.90.01			MERCEDES-BENZ	372 375 377
				378 381 388
				396
3620.90.02			MERCEDES-BENZ	310 311 314
				315 316 317
				318 319 320
				322 324 326
				328 330 333
				356 361 362
				363 371 375
3620.90.03			DAF	20
3620.90.05			DAF	20 21
3620.90.06			DAF	21
3620.90.07			DAF	20 21
3620.90.08			DAF	21 22

Arithmetical list

Reference	Parameter	Hub profile	Manufacturer	Page		
3620.90.09			MAN	187 227 230	188 228	190 229
3620.90.10			MAN	151 189 194 200 232	187 191 195 201	188 192 199 230
			STEYR	572 575	573 576	574
3620.90.11			MAN	187	188	190
3620.90.19			MAN	227 230	228	229
3620.90.28			RENAULT TRUCKS	515	516	
3620.90.29			RENAULT TRUCKS	516		
3620.90.30			MAN	192	230	232
3620.90.32			MERCEDES-BENZ	310 313 316 319 324 330 336 347	311 314 317 320 326 333 338	312 315 318 322 328 335 343
3620.90.42			MERCEDES-BENZ	310 313 316 319 324 330 336 347	311 314 317 320 326 333 338 356	312 315 318 322 328 335 343 361
3620.90.50			IVECO	60	68	69
3620.90.51			IVECO	60 69	62	68
3620.90.52			IVECO	62	67	
3626.30.00	362 WGTZ	36X40 -18N	MERCEDES (TÜRKİYE)	281		
3627.30.00	362WGTB	36x40-18N	MERCEDES-BENZ	310 313 316 319 324 330 336 347 362 372 378 396	311 314 317 320 326 333 338 356 363 375 381	312 315 318 322 328 335 343 361 371 377 388
3800.90.10			VOLVO	582	589	602
3800.90.11			VOLVO	583		
3800.90.14			MAN	196	197	198
3800.90.48			VOLVO	582	602	
3800.90.49			VOLVO	582		
3800.90.52			DAF	11 14	12 22	13
3801.20.00	G380KR		IVECO	95		
			TAM	581		
3802.20.00	G380KR		TAM	581		
3802.30.00	380GSZ	1 3/4"-10Z	TAM	581		
3803.20.00	G380KR		VOLVO	582 632	585	587

Arithmetical list

Reference	Parameter	Hub profile	Manufacturer	Page
3804.20.00	G380KR		IVECO	124 408 409
			KAEUBLE	126
			MAGIRUS-DEUTZ	133
			MAGIRUS-DEUTZ	137 138 139
				140 141 142
				144 146
			MAN	256 258
			ÖSTERREICHISCHE AUTOMOBILFABRIK (ÖAF)	468
		STEYR	571 573	
3805.30.00	380WGSZ	32X40-10Z	MAGIRUS-DEUTZ	136 137 138 139 141 142
3806.30.00	380W2GSZ	1 3/4"-10Z	MAN	199
			RENAULT TRUCKS	525
3807.20.00	G380KR		FAUN	42 43 44
			KAEUBLE	126 127
			KRUPP	131
			MAGIRUS-DEUTZ	136 137 138
			MERCEDES-BENZ	364 365
3808.30.00	380GSZ	2"-10Z	VOLVO	582 584 631
3810.20.00	G380KR		KRUPP	131
			MAGIRUS-DEUTZ	138
			MAGIRUS-DEUTZ	139 140 142
38101.30.00	380GVZ	2"-10Z	VOLVO	584 632
			VOLVO (TÜRKİYE)	633
38102.30.00	380GVZ	2"-10Z	VOLVO	584 632
			VOLVO (TÜRKİYE)	633
38104.30.00	380GTZ	2" -10N	VOLVO	584 632
38105.30.00	380GTZ	2" -10N	VOLVO	584 632
38106.30.00	380WGTZ	1 3/4" SAE 10C	MAN (TÜRKİYE)	278
38107.30.00	380 GTZ	1 3/4" SAE 10N	DAF (TÜRKİYE)	40
			MAN (TÜRKİYE)	278
			MERCEDES (TÜRKİYE)	281
38109.30.00	380GTZ	1 3/4"-10N	IVECO	65 66 67 71 74 77
38115.30.00	380GSZ	1 3/4"-10Z	IVECO	86 88 90 94 116 117 118 119
3812.30.00	380GSZ	36X45-10Z	FAUN	43 44
			IVECO	123
			IVECO	124
			KRUPP	131
			MAGIRUS-DEUTZ	133
			MAGIRUS-DEUTZ	138 139 140
				142 145 146
			RENAULT TRUCKS	525
38125.30.00	380GS	2"-10Z	MERCEDES-BENZ	443 452 455 457 459
3814.20.00	G380KR		MAN	253
3816.30.00	380GSZ	1 3/4"-10Z	IVECO	71 95 123
			MAGIRUS-DEUTZ	138
			MAGIRUS-DEUTZ	139 140 142
				143
			MAN	199
			ÖSTERREICHISCHE AUTOMOBILFABRIK (ÖAF)	464
3819.20.00	GF380KR		STEYR	579 580

Arithmetical list

Reference	Parameter	Hub profile	Manufacturer	Page		
3821.20.00	GF380KR		LIEBHERR	132		
			MAN (TÜRKİYE)	278		
			MERCEDES-BENZ	379	384	385
				386	392	393
				394	395	399
				400	401	405
				412	413	414
				415	420	423
				424	425	426
				436	437	
3821.30.00	380GSZ	1 3/4"-10Z	MERCEDES-BENZ	379	381	384
				385	386	389
				390	392	393
				394	396	397
				399	400	401
				402	405	406
				412	413	414
				415	420	423
				424	425	426
				429	436	437
3822.20.00	GF380KR		KAELBLE	126		
			LIEBHERR	132		
			MERCEDES (TÜRKİYE)	281		
			MERCEDES-BENZ	365	381	385
				389	390	393
				396	397	398
				399	400	401
				402	404	405
				406	409	412
				413	414	415
419	420	424				
425	426	436				
3822.30.00	380GSZ	36X45-10Z	KAELBLE	126		
			MERCEDES-BENZ	393	398	399
				400	401	402
				413	414	415
				419	420	424
425	426	436				
3827.20.00	GF380KR		MERCEDES-BENZ	405	412	413
3829.20.00	GF380KR		DAF	11	12	
3831.20.00	GF380KR		MERCEDES-BENZ	385	393	394
				401	402	420
				425	429	430
3835.20.00	GF380		MAN	256	257	258
				259	260	262
				263	264	266
				267	268	269
				271	273	275
			RENAULT TRUCKS	525	526	
3835.30.00	380GTZ	1 3/4"-10N	VOLVO	586	631	
3839.30.00	380GSZ	2"-10Z	VOLVO	582	583	584
3848.50.00	GF2/380		LIEBHERR	132		
			MAN	261	264	265
				266	267	268
				270	272	274
				275	276	277
VOLVO	585	630	631			
3849.20.00	G380KR		VOLVO	584	587	631
3852.30.00	380GS	1 3/4"-10Z	DAF	11	12	13
3854.30.00	380GVZ	2"-10N	MERCEDES-BENZ	407	412	419
				422	439	445
				448	449	455
				459	460	

Arithmetical list

Reference	Parameter	Hub profile	Manufacturer	Page
3855.30.00	380GS	2"-10Z	MERCEDES (TÜRKİYE)	281
			MERCEDES-BENZ	403 404 417
				421 427 440
				450 451 452
				453
3856.10.00	GF2/380		MAN	261 264 265
				266 268 270
				272 274 275
				276
3856.20.00	G380KR		MAN	261 264 265
				266 268 270
				272 274 275
				276
3857.10.00	GF2/380		MERCEDES-BENZ	403 404 418
				421 427 428
				431 438 440
				441 442 446
				450 451 454
				457 458
3857.20.00	G380KR		MAN	258
			MERCEDES-BENZ	403 404 418
				421 427 428
				431 438 440
				441 442 446
				450 451 454
				457 458
3857.30.00	380W2GSZ	1 3/4"-10Z	MAGIRUS-DEUTZ	141 143 144
				412
			MAN	193 194 195
				196 197 198
				256 257 258
				259 260 262
				263 264 266
				267 268 269
				271 273 275
			STEYR	575 576 579
			TAM	581
3857.50.00	GF2/380		MERCEDES-BENZ	403 404 418
				427 428 431
				438 440 441
				442 446 450
				451 454 457
				458
3860.20.00	GM380K		SISU	571
			VOLVO	582 589 602
3861.20.00	GM380		MAN	271
3861.30.00	380W2GSZ	36X45-10Z	MAGIRUS-DEUTZ	139 140 142
				145 146
			MAN	255 256 258
				260 263 265
				266 269
			ÖSTERREICHISCHE AUTOMOBILFABRIK (ÖAF)	464 465 466
			RENAULT TRUCKS	525 526 527
			STEYR	571 579 580
3863.20.00	GM380		RENAULT TRUCKS	509 515
3866.20.00	GM380K		RENAULT TRUCKS	473 480 482
				484 485 504
				506 510 512
				526 527 529
				530 531
3868.20.00	15" GM380		ASKAM CHRYSLER (TÜRKİYE)	1
			BMC (TÜRKİYE)	6
3870.30.00	380/210GSZ	1 3/4"-10Z	KAMAZ	128 129
			LIEBHERR	132
			MAN	261 264 267
				274 277
			VOLVO	585 587 630

Arithmetical list

Reference	Parameter	Hub profile	Manufacturer	Page		
3871.30.00	380/70GSZ	1 3/4"-10Z	LIEBHERR	132		
			MAN	193	194	195
				196	197	198
				202	260	261
				264	267	274
				277		
			MERCEDES-BENZ	405	412	413
				424	438	
			VOLVO	585	586	587
				630	631	
3872.30.00	380GSZ	42x52-10N	MERCEDES-BENZ	425 436		
3877.20.00	GMF380		MAN	257 259 260 262		
3878.20.00	GMF380		DAF	11 12 13 14 22		
			DAF (TÜRKİYE)	40		
			MAN	193	194	195
				196	197	198
199						
3878.30.00	380/210GSZ	41X45-22Z	SCANIA	534 535		
			SCANIA (TÜRKİYE)	570		
3879.20.00	GMF380		DAF	11 13 14		
			MAN	193	194	195
				196	197	198
				199		
ÖSTERREICHISCHE AUTOMOBILFABRIK (ÖAF)	464					
3882.10.00	GF2/380		MERCEDES (TÜRKİYE)	281		
			MERCEDES-BENZ	403	404	417
				421	427	440
				450	451	452
453						
3882.20.00	GF2/380		MERCEDES (TÜRKİYE)	281		
			MERCEDES-BENZ	403	404	417
				418	419	420
				421	427	428
				440	443	450
				451	452	453
				455	457	459
3882.30.00	380GSZ	2"-10Z	MERCEDES (TÜRKİYE)	281		
3882.50.00	GF2/380		MERCEDES-BENZ	403	404	417
				418	419	421
				427	428	431
				438	440	441
				442	443	446
				450	451	452
				453	454	455
				457	458	459
3883.30.00	380GSZ	2"-10	MERCEDES-BENZ	403	404	417
				421	427	440
				450	451	452
				453		
3884.30.00	15" 380GSZ	1 3/4" SAE 10C	ASKAM CHRYSLER (TÜRKİYE)	1		
			BMC (TÜRKİYE)	6		
3885.30.00	380GSZ	1 3/4"-10Z	LIEBHERR	132		
3886.30.00	380GSZ	1 3/4"-10Z	VOLVO	582 589 601 602		
3887.10.00	GF2/380		MERCEDES-BENZ	404 418 419 428		
3888.30.00	380WGSZ	1 3/4"-10Z	MERCEDES-BENZ	404 405 409		
3889.10.00	GF2/380		LIEBHERR	132		
			MAN	261 267 274		
			VOLVO	585		
3889.30.00	380GSZ	2"-10Z	MERCEDES-BENZ	404 418 419 428 455		
3890.10.00	GF2/380		VOLVO	582 583 584 631		

Arithmetical list

Reference	Parameter	Hub profile	Manufacturer	Page			
3891.30.00	380GS	2"-10Z	MERCEDES-BENZ	404 407 412			
				417 418 419			
				422 428 439			
				445 448 449			
				455 459 460			
3892.20.00	GF2/380		LIEBHERR	132			
				MAN	261 264 267		
					274 277		
				VOLVO	584 585 586		
					587 630 631		
		VOLVO (TÜRKİYE)	633				
3892.30.00	380GSZ	2"-10Z	MERCEDES-BENZ	403 404 418			
				421 427 428			
				431 438 440			
				441 442 443			
				446 450 451			
				452 454 455			
				457 458 459			
3893.10.00	GF2/380		MERCEDES-BENZ	443 452 455			
				457 459			
3894.30.00	380GSZ	1 3/4"-10Z	MAN	261 264 265			
				266 268 270			
				272 274 275			
				276			
3895.20.00	G380KR		FAUN	43 44			
				IVECO	71 86 88		
					90 94 116		
			117 118 119				
			123				
			MAGIRUS-DEUTZ	133			
			MAGIRUS-DEUTZ	139 140 141			
	142 143 145						
3896.30.00	380WGSZ	1 3/4"-10Z	MAN	261 264 265			
				266 268 270			
				272 274 275			
				276			
3897.30.00	380GSZ	1 3/4"-10Z	DAF	11 12 13			
				14 22			
			MERCEDES-BENZ	395 425 430			
3899.30.00	380GSZ	32X40-10Z	MAGIRUS-DEUTZ	133			
			MAGIRUS-DEUTZ	138			
			MAN	253			
3903.40.00	KZIS-0		FIAT	44 45			
3950.90.01			MAN	200 201 203			
				MERCEDES-BENZ	310 311 312		
			313 314 315				
			316 317 318				
			319 320 322				
			324 326 328				
			330 331 333				
			335 336 337				
			338 339 340				
			341 342 343				
			344 347				
			STEYR		575		
			3950.90.02				MAN
				199 200 201			
202 203 204							
224 228 230							
231 232							
STEYR	574 575 576						
	577						

Arithmetical list

Reference	Parameter	Hub profile	Manufacturer	Page		
3950.90.03			MERCEDES-BENZ	312	313	314
				315	317	318
				319	320	321
				322	323	324
				325	326	327
				328	329	330
				331	332	333
				334	336	337
				338	339	340
				341	342	343
				344	347	
3950.90.06		38,2x44,5-10N	DAF	20	21	22
3950.90.07			DAF	20	21	22
3950.90.08			DAF	22	24	25
				26	27	
3950.90.09			DAF	21		
3950.90.12			RENAULT TRUCKS	510	517	
3950.90.15			MAN	224	228	229
				230	231	232
3950.90.20	395		RENAULT TRUCKS	476	481	516
			VOLVO	521	588	589
				606	605	
3950.90.21			MERCEDES-BENZ	312	313	314
				315	317	318
				319	320	322
				324	326	328
				330	333	335
				336	338	339
				343	347	
3950.90.24			RENAULT TRUCKS	476	481	
			VOLVO	589	606	
3950.90.25			MAN	224	228	229
				230	232	
3950.90.31			MERCEDES-BENZ	310	311	312
				313	314	315
				316	317	318
				319	320	322
				324	326	328
				330	331	333
				335	336	337
				338	339	340
				342	343	344
				347		
3950.90.32			RENAULT TRUCKS	515		
3950.90.33			MERCEDES-BENZ	312	313	314
				315	317	318
				319	320	321
				322	323	324
				325	326	327
				328	329	330
				331	332	333
				334	335	336
				337	338	339
				340	341	342
				343	344	347
3950.90.34			MERCEDES-BENZ	310	311	312
				313	314	315
				316	317	318
				319	320	322
				324	326	328
				330	331	333
				335	336	337
				338	339	340
342	343	344				
347						

Arithmetical list

Reference	Parameter	Hub profile	Manufacturer	Page		
3950.90.35			MERCEDES-BENZ	310	311	312
				313	314	315
				316	317	318
				319	320	322
				324	326	328
				330	333	335
				336	338	339
343	347					
3950.90.36			MERCEDES-BENZ	312	313	335
				338	339	343
				347		
3950.90.37			MERCEDES-BENZ	312	313	314
				315	317	318
				319	320	322
				324	326	328
				330	333	335
				336	338	339
				343	347	
3950.90.38			MERCEDES-BENZ	312	313	314
				315	317	318
				319	320	321
				322	323	324
				325	326	327
				328	329	330
				331	332	333
				334	335	336
				337	338	339
				340	341	342
				343	344	347
3950.90.39			MERCEDES-BENZ	312	313	335
				338	339	343
				347		
3950.90.40			MERCEDES-BENZ	312	313	314
				315	317	318
				319	320	322
				324	326	328
				330	333	335
				336	338	339
				343	347	
3950.90.42			MERCEDES-BENZ	312	313	314
				315	317	318
				319	320	322
				324	326	328
				330	333	335
				336	338	339
				343	347	
3951.20.00	MF395		KAMAZ	128	129	130
			MAZ	279	280	
			MERCEDES (TÜRKİYE)	281		
			MERCEDES-BENZ	312	313	314
				315	317	318
				319	320	321
				322	323	324
				325	326	327
				328	329	330
				331	332	333
				334	335	336
				337	338	339
				340	341	342
			343	344	347	
356	357	361				
3951.30.00	395WGTZ	1 3/4"-10Z	MAN	151	187	198
				199	200	201
				202	203	204
				224	228	229
				230	231	232
			MAN (TÜRKİYE)	278		
			MAZ	279	280	
			STEYR	574	575	576
			577			

Arithmetical list

Reference	Parameter	Hub profile	Manufacturer	Page			
3952.20.00	MF395		MAN	200 201 203			
			MERCEDES-BENZ	310 311 312			
				313 314 315			
				316 317 318			
				319 320 322			
				324 326 328			
				330 331 333			
				335 336 337			
				338 339 340			
				341 342 343			
				344 347			
			STEYR	575			
			3952.30.00	395WGTZ	1 1/2-10N	DAF	20 21 22
			3953.20.00	MF395		DAF	20 21 22
							24 25 26
	27 28						
IVECO	60 65 67						
70							
	KAMAZ	127					
	KAMAZ	128					
3953.30.00	395WGTZ	1 3/4"-10N	DAF	20 21 22			
				24 25 26			
				27			
3954.30.00	395WGTZ	1 3/4"-10N	DAF	21			
			KAMAZ	127			
3955.30.00	395WGTZ	1 3/4"-10N	FORD	48			
			VOLVO	633			
3956.20.00	MFZ395		MAN	151 187 198			
				199 200 201			
				202 203 204			
				224 228 229			
				230 231 232			
			MAN (TÜRKİYE)	278			
			STEYR	574 575 576			
				577			
3957.20.00	MFZ395		RENAULT TRUCKS	510 517			
3957.30.00	395WGTZ	1 3/4"-10N	MAN	229			
3960.30.00	395GTZ	36X40-18Z	MAN	200 201 203			
			MERCEDES-BENZ	310 311 312			
				313 314 315			
				316 317 318			
				319 320 322			
				324 326 328			
				330 331 333			
				335 336 337			
				338 339 340			
				341 342 343			
				344 347			
			STEYR	575			
			3961.20.00	MF395		RENAULT TRUCKS	476 480 481
							515 516 521
						VOLVO	588 589 605
				606			
3961.30.00	395GTZ	36X40-18	MERCEDES (TÜRKİYE)	281			
			MERCEDES-BENZ	311 312 313			
				314 315 317			
				318 319 320			
				321 322 323			
				324 325 326			
				327 328 329			
				330 331 332			
				333 334 335			
				336 337 338			
				339 340 341			
				342 343 344			
				347			

Arithmetical list

Reference	Parameter	Hub profile	Manufacturer	Page
3962.20.00	15.5" MF 395		ASKAM CHRYSLER (TÜRKİYE)	1
			BMC (TÜRKİYE)	7
			FORD (TÜRKİYE)	48
3962.30.00	395GTZ	1 3/4"-10	KAMAZ	128 129 130
			RENAULT TRUCKS	510 517
3965.30.00	15.5" 395GTZ	1 3/4" SAE 10C	ASKAM CHRYSLER (TÜRKİYE)	1
			BMC (TÜRKİYE)	7
			FORD (TÜRKİYE)	48
			KAMAZ	127
3971.30.00	395WGTZ	36x40-18N	MERCEDES-BENZ	312 313 314
				315 317 318
				319 320 322
				324 326 328
				330 333 335
				336 338 339
				343 347
3972.20.00	MF395		MAN	224 228 229
				230 232
			MERCEDES-BENZ	361
3973.30.00	395WGTZ	1 3/4"-10N	RENAULT TRUCKS	476 481 515
				516 521
			VOLVO	588 589 605
3974.30.00	395WGTZ	1 3/4" -10N	RENAULT TRUCKS	476 481
			VOLVO	589 606
4000.90.01	ΔVHD		MAN	165 166 167
				168 169 170
				171 173 174
				175 179 180
				181 182 183
				184
			MERCEDES-BENZ	435
			ÖSTERREICHISCHE AUTOMOBILFABRIK (ÖAF)	467
4000.90.03			MERCEDES-BENZ	297 408 411
				412 419 422
				431 434 435
				436 440 441
				442 443 444
				445 447 448
				449 450 453
				454 455 456
				460
			4000.90.04	
MERCEDES-BENZ	282 283 284			
	285 286 287			
	288 289 290			
	291 292 293			
	294 295 296			
	297 298 299			
	300 301 302			
	303 304 305			
	306 307 308			
	309 310 341			
	344 345			
4000.90.07				
				496 497 498
				499 500 501
				517 518 519
				520
4000.90.08	⊕		VOLVO	595 596 598
				599 618 632
4000.90.09	⊕		VOLVO	595 596 618
4000.90.10	⊕		VOLVO	596 597 601
				618 619

Arithmetical list

Reference	Parameter	Hub profile	Manufacturer	Page					
4000.90.12			RENAULT TRUCKS	489	490	491			
				492	493	495			
				496	500	501			
				502	517	518			
				519	520	521			
				522	523				
4000.90.13			RENAULT TRUCKS	490	491	492			
				497	501				
4000.90.15	⊕		VOLVO	597	601				
4000.90.17			MERCEDES-BENZ	282	283	284			
				285	286	287			
				288	289	290			
				291	292	293			
				294	295	296			
				297	298	299			
				300	301	302			
				303	304	305			
				306	307	308			
				309	310	344			
				345					
4000.90.18		MFZ2/400X	MERCEDES-BENZ	286					
4000.90.19	⊕		RENAULT TRUCKS	479	497	501			
				502	503	504			
				509					
4000.90.20			RENAULT TRUCKS	500	501				
4000.90.28			VOLVO	590	592	598			
				599	608	609			
				610	611	613			
				614	615	616			
				620	622	624			
4000.90.29	⊕		VOLVO	591	592	593			
				611	612	613			
				615	622	623			
				624					
4000.90.60	⊕		SCANIA	535	536	537			
				538	539	540			
4000.90.61	⊕		IVECO	67					
				SCANIA	535	536	537		
					538	539	540		
4001.10.00		MFZ2/400X	MAN	165	166	167			
				168	169	170			
				171	173	174			
				175	179	180			
				181	182	183			
			184						
			MERCEDES-BENZ	435					
				ÖSTERREICHISCHE AUTOMOBILFABRIK (ÖAF)	467				
			4001.20.00		MFZ2/400X	MERCEDES (TÜRKİYE)	281		
							MERCEDES-BENZ	410	419
RENAULT (TÜRKİYE)	472								
RENAULT TRUCKS	494	495					498		
499									
SISU	571								
4001.50.00		MFZ2/400X	VOLVO	618					
4005.30.00		400GVZ	1 3/4"-10N	IVECO	74	75	77		
					83	97	101		
					103	104			
4006.30.00		400GVZ	2"-10N	IVECO	74	76	77		
					84				
4007.30.00		400WGTZ	2"-10N	IVECO	74	75	76		
					77	83	84		
					85	97	98		
					103	104	105		
					108				
4008.30.00		400 WGVZ	1 3/4" SAE 10C	MAN	175	177	179		
					180	182	183		
					184	185	277		

Arithmetical list

Reference	Parameter	Hub profile	Manufacturer	Page				
4009.30.00	400WGVZ	2"-10Z	MAN	176 177 178				
				179 180 181				
				182 183 184				
				185 186 199				
				277				
4010.10.00	MFZ2/400X		MERCEDES (TÜRKİYE)	281				
				MERCEDES-BENZ	297 408 410			
					411 412 419			
					422 431 434			
					435 436 440			
					441 442 443			
					444 445 447			
					448 449 450			
					453 454 455			
					456 460			
4010.30.00	400WGVZ	2"-10Z	MAN	165 166 167				
				168 169 170				
				171 173 174				
				175 179 180				
				181 182 183				
				184				
				MERCEDES-BENZ	435			
ÖSTERREICHISCHE AUTOMOBILFABRIK (ÖAF)	467							
4011.30.00	400GVZ	73X83-6N	MAN	179 180 181 183 184				
4020.30.00	400GVZ	2"-10Z	MERCEDES (TÜRKİYE)	281				
				MERCEDES-BENZ	410 419			
4021.10.00	MFZ2/400X		MERCEDES-BENZ	286				
4021.30.00	400GVZ	2"-10Z	MERCEDES (TÜRKİYE)	281				
				MERCEDES-BENZ	297 408 410			
					411 412 419			
					422 431 434			
					435 436 440			
					441 442 443			
					444 445 447			
					448 449 450			
					453 454 455			
					456 460			
4022.10.00	MFZ2/400X		MERCEDES-BENZ	282 283 284				
				285 286 287				
				288 289 290				
				291 292 293				
				294 295 296				
				297 298 299				
				300 301 302				
				303 304 305				
				306 307 308				
				309 310 344				
				345				
				4025.10.00	MFZ2/400X		MERCEDES (TÜRKİYE)	281
								MERCEDES-BENZ
285 286 287								
288 289 290								
291 292 293								
294 295 296								
297 298 299								
300 301 302								
303 304 305								
306 307 308								
309 310 341								
344 345								
4025.30.00	400WGTZ	45x50-18N	MERCEDES (TÜRKİYE)					
				MERCEDES-BENZ	282 283 284			
					285 286 287			
					288 289 290			
					291 292 293			
					294 295 296			
					297 298 299			
					300 301 302			
					303 304 305			
					306 307 308			
					309 310 341			
					344 345			

Arithmetical list

Reference	Parameter	Hub profile	Manufacturer	Page			
⊗ 4026.10.00	MFZ2/400X		RENAULT (TÜRKİYE)	472			
			RENAULT TRUCKS	489 490 491			
				492 493 494			
				495 496 497			
				498 499 500			
				501 502 517			
				518 519 520			
				521 522 523			
			SISU	571			
			⊗ 4026.30.00	400GTZ	68x80-8Z	MAN	165
MAN (TÜRKİYE)	278						
⊗ 4026.50.00	MFZ2/400X		RENAULT TRUCKS	498			
⊗ 4027.10.00	⊕ MFZ2/400X		VOLVO	590 592 595			
				596 597 598			
				599 601 608			
				609 610 611			
				613 614 615			
				616 618 619			
				620 622 624			
				632			
⊗ 4027.30.00	400WGVZ	50X55-20Z	RENAULT (TÜRKİYE)	472			
			RENAULT TRUCKS	479 490 491			
				492 496 497			
				498 499 500			
				501 502 503			
				504 509 517			
				518 519 520			
			SISU	571			
			⊗ 4027.60.00	⊕ MFZ2/400X		VOLVO	595 596 597
							601 613 614
	616 618						
VOLVO (TÜRKİYE)	633						
⊗ 4028.10.00	MFZ2/400X					MAN	149 150 151
							154 156 157
				158 159 160			
				161 162 163			
				164 165 204			
				206 207 209			
				210 211 212			
				213 214 225			
				226 227 233			
				234 235 236			
				237 238 239			
				240 241 242			
				243 244 245			
				246 247 248			
	249 250 251						
	252						
	MAN (TÜRKİYE)	278					
	STEYR	572 576 578					
⊗ 4028.30.00	400GTZ	73X83-6N	RENAULT (TÜRKİYE)	472			
			RENAULT TRUCKS	494 495 498			
			SISU	499 571			
⊗ 4029.10.00	MFZ2/400X		RENAULT TRUCKS	500 501			
⊗ 4029.30.00	400GTZ	2"-10N	RENAULT (TÜRKİYE)	472			
			RENAULT TRUCKS	489 490 491			
				492 493 494			
				495 496 497			
				498 499 500			
				501 502 517			
				518 519 520			
				521 522 523			
⊗ 4031.30.00	400GTZ	68x80-8Z	VOLVO (TÜRKİYE)	633			

Arithmetical list

Reference	Parameter	Hub profile	Manufacturer	Page						
⊗ 4032.30.00	400WGTZ	46X50-24Z	VOLVO	590	591	592				
				593	595	596				
				598	599	608				
				609	610	611				
				612	613	614				
				615	616	618				
				620	622	623				
				624	632					
							VOLVO (TÜRKİYE)	633		
				⊗ 4033.30.00	400WGTZ	2"-10N	VOLVO	596	597	601
618	619									
			VOLVO (TÜRKİYE)					633		
⊗ 4036.10.00	⊕ MFZ2/400X		RENAULT TRUCKS	479	497	501				
				502	503	504				
				509						
⊗ 4036.30.00	400 WGTZ	2"-10N	MAN	149	150	161				
				162	163	164				
				165	204	207				
				209	210	211				
				212	213	214				
				225	226	227				
				233	234	235				
				236	237	238				
				239	240	241				
				242	243	244				
				245	246	247				
				248	249	250				
				251	252					
							MAN (TÜRKİYE)	278		
⊗ 4037.30.00	400WGTZ	50x55-20N	RENAULT TRUCKS	500	501					
⊗ 4047.10.00	MFZ2/400X		VOLVO	591	592	593				
				594	595	596				
				598	611	612				
				613	615	618				
				619	622	623				
				624	632					
⊗ 4051.30.00	400WGVZ	46x50-24N	SCANIA	535	536	537				
				538	539	540				
				541	542	543				
				544	545	546				
				547	548	549				
				550	551	552				
				553	554	555				
⊗ 4052.30.00	400GVZ	41x45-22N	IVECO	67						
							SCANIA	535	536	537
				538	539	540				
⊗ 4055.30.00	400GVZ	2"-10N	VOLVO	603	604					
⊗ 4060.26.00	MFZ400X		SCANIA	536	537	538				
				539	540					
⊗ 4060.60.00	⊕ MFZ400X		IVECO	67						
							SCANIA	535	536	537
				538	539	540				
⊗ 4200.90.02			DAF	35	37					
⊗ 4200.90.03			MAN	261	264	265				
				266	267	268				
				270	272	274				
				275	276	277				
⊗ 4200.90.16			MERCEDES-BENZ	400	401	402				
				403	415	416				
				420	421	422				
				423	424	426				
				427	429	437				
				438	440	445				
				446	447	450				
				451	452	453				
⊗ 4200.90.17			MERCEDES-BENZ	438	458					
⊗ 4200.90.22			DAF	16	17	27				
⊗ 4200.90.49			IVECO	117	118	119				
				121	123	124				
				125						

Arithmetical list

Reference	Parameter	Hub profile	Manufacturer	Page
4200.90.71			VOLVO	585 587 630 631 632
4200.90.77			DAF	15 18 35
4200.90.78			DAF	16 17 18 34
4200.90.81			DAF	22 23
4200.90.82			DAF	27 35
4200.90.83			DAF	30 35 36 37
4200.90.84	●		SCANIA	532 533 534 535 536 537 538 539 540
4201.20.00	G420KR		DAF	14
			FAUN	42 43 44
			KAELBLE	126 127
			KRUPP	131
			ÖSTERREICHISCHE AUTOMOBILFABRIK (ÖAF)	468
			PERLINI	469
			SCANIA	531 532 533
			SCANIA (TÜRKİYE)	570
			TAM	581
4203.20.00	G420KR		VOLVO	585 587 630 631 632
4203.30.00	420GS	36X45-10Z	ÖSTERREICHISCHE AUTOMOBILFABRIK (ÖAF)	468
			RENAULT TRUCKS	526 527
4205.20.00	G420KR		DAF	7 8 14 19 20 28 40
4208.30.00	420GS	1 3/4"-10Z	DAF	7 8 14 19 20 28 40
			IVECO	124 125 408
			IVECO	88 89 90 94 95 117 118 119 120 121 122 123
			MAGIRUS-DEUTZ	142 143 146 147 148
			SCANIA	531 532 533
4209.30.00	420GS	1 3/4"-10Z	SCANIA	531 532 533
4210.30.00	420/210GSZ	1 3/4"-10Z	DAF	17 19
42105.30.00	420 WGTZ	1 3/4" SAE 10C	MAN (TÜRKİYE)	278
42106.30.00	420WGTZ	46x50-24N	SCANIA	535 536 537 538 539 540
4211.20.00	G420KR		SCANIA	534
4211.30.00	420/210GSZ	41X45-22N	SCANIA	533 534 535 536 537 538 539 540
4212.30.00	420/210GSZ	2"-10N	MERCEDES (TÜRKİYE)	281 282
			VOLVO (TÜRKİYE)	633
4222.20.00	GF420KR		DAF	15
			MAGIRUS-DEUTZ	140 143 145 146
			MAN	256 257 260 263 266 269 271
			MERCEDES-BENZ	424
			ÖSTERREICHISCHE AUTOMOBILFABRIK (ÖAF)	464 465 466
			RENAULT TRUCKS	526 527
4222.30.00	420BH	36x45-10N	RENAULT TRUCKS	527

Arithmetical list

Reference	Parameter	Hub profile	Manufacturer	Page			
4224.20.00	GF420KR		MAGIRUS-DEUTZ	144 145 146			
			MAN	260 261 267			
				268 271 272			
				273 274			
4225.20.00	GF420KR		MERCEDES-BENZ	400 402 403			
				415 416 420			
				421 424 425			
				426 427			
			MERCEDES-BENZ	429 431 437			
				438 440 441			
				445 446 447			
				450 451 452			
4226.20.00	GF420KR		MAGIRUS-DEUTZ	140 143 145			
				146 147			
			MERCEDES-BENZ	384 385 386			
				392 393 394			
				395 400 413			
				414 423 424			
				437			
			RENAULT TRUCKS	526 527			
			4231.30.00	420GSZ	36X45-10N	MERCEDES-BENZ	403 416 421
							425 426
4232.30.00	420GSZ	1 3/4"-10Z	MERCEDES (TÜRKİYE)	281			
4234.20.00	GF420KR		DAF	15			
			MERCEDES-BENZ	384 385 386			
				392 393 394			
				395 414 423			
				437			
	ÖSTERREICHISCHE AUTOMOBILFABRIK (ÖAF)	464 465					
4234.30.00	420/210GSZ	1 3/4"-10Z	MERCEDES-BENZ	400 413			
			ÖSTERREICHISCHE AUTOMOBILFABRIK (ÖAF)	466			
4235.20.00	GF420KR		IVECO	120 121 123			
			IVECO	124 125			
			MAGIRUS-DEUTZ	144 145 146			
				147			
			MAN	257 259 260			
				261 263 264			
				265 266 267			
				268 269 270			
				271 272 273			
				274 275			
			MAN (TÜRKİYE)	278			
			MERCEDES (TÜRKİYE)	281			
			MERCEDES-BENZ	400 401 402			
				403 415 416			
				420 421 422			
	423 424 425						
	426 427 429						
	437 438 440						
	445 446 447						
	450 451 452						
	453 458						
4235.30.00	420/210GS	1 3/4"-10Z	MAGIRUS-DEUTZ	146			
			MAN	264 269			
			SCANIA (TÜRKİYE)	570			
4236.20.00	GF420KR		IVECO	124 125 126			
				407 408			
			IVECO	95 112 117			
				118 119 121			
	122 123						
4236.30.00	420/210GSZ	36X45-10Z	MAGIRUS-DEUTZ	140 143 144			
				145 146 147			
				148			

Arithmetical list

Reference	Parameter	Hub profile	Manufacturer	Page		
4237.20.00	GF420KR		IVECO	88	89	90
				94	95	123
				125		
			MAGIRUS-DEUTZ	141	142	143
				144		
4237.30.00	420GSZ	36x45-10N	IVECO	120	121	123
4240.30.00	420/210GSZ	1 3/4"-10Z	STEYR	576	577	579
				580		
4244.20.00	GFX420KR		MAN	261	264	265
				266	267	268
				270	272	274
				275	276	277
			MAN (TÜRKİYE)	278		
			MERCEDES (TÜRKİYE)	282		
			MERCEDES-BENZ	402	403	404
				417	418	421
				422	426	427
				430	440	441
	445	446	450			
	451	454	457			
				458		
			STEYR	579	580	
4244.30.00	420/210GSZ	1 3/4"-10Z	DAF	15	16	17
				18	19	22
				23	27	35
			FAUN	43		
			MERCEDES-BENZ	406	407	415
				432	437	
4247.30.00	420GSZ	42X52-10Z	IVECO	124	125	
			MAGIRUS-DEUTZ	146	147	
4248.20.00	GFX420KR		DAF	16	17	27
4248.30.00	420W2GSZ	36X45-10Z	DAF	17		
4249.30.00	420W2GSZ	1 3/4"-10Z	MAGIRUS-DEUTZ	139	141	144
4250.20.00	GFX420KR		KALBLE	127		
			MAGIRUS-DEUTZ	145	148	
			MERCEDES-BENZ	403	416	421
				426	440	
			STEYR	576	577	579
				580		
4250.30.00	420WGSZ	1 3/4"-10Z	IVECO	92	112	119
				122		
			MAN	257	259	260
				261	263	264
				265	266	267
				268	269	270
				271	272	273
				274	275	
			MAN (TÜRKİYE)	278		
			TAM	581		
4253.20.00	GFX420KR		ASTRA	1		
			IVECO	124	125	
			IVECO	71	88	89
				91		
			TAM	581		
4254.30.00	420GSZ	1 3/4"-10Z	VOLVO	585	587	630
				631	632	
4255.30.00	420GS	1 3/4"-10Z	DAF	14	15	
4256.20.00	GMF420K		DAF	15	16	17
				18	19	27
				30	34	35
				36	37	
			DAF (TÜRKİYE)	40	41	
4256.30.00	420GS	1 3/4" SAE 10C	DAF (TÜRKİYE)	40		

Arithmetical list

Reference	Parameter	Hub profile	Manufacturer	Page					
⊗ 4257.20.00	GMF420K		DAF	15	17	18			
				19	22	23			
			VOLVO (TÜRKİYE)	40					
				633					
⊗ 4257.30.00	420GSZ	1 3/4"-10Z	MAGIRUS-DEUTZ	144					
			MERCEDES-BENZ	400	401	402			
				403	415	416			
				420	421	422			
				423	424	426			
				427	429	433			
				437	438	440			
				445	446	447			
				450	451	452			
						453			
			STEYR	577	579	580			
⊗ 4258.30.00	420GSZ	1 3/4"-10Z	MAN (TÜRKİYE)	278					
			MERCEDES-BENZ	425	426	438			
				457	458				
			STEYR	579					
⊗ 4259.30.00	420GSZ	2"-10Z	DAF	27	30	35			
				36	37	40			
⊗ 4260.30.00	420GSZ	42X52-10	MERCEDES-BENZ	421	422	426			
				427	430	440			
				441	445	446			
				450	451	454			
				457	458				
⊗ 4261.20.00	GMF420K		SCANIA	531	532				
⊗ 4261.30.00	420GSZ	41X45-22Z	SCANIA	531	532	533			
				534	535	536			
				537	538	539			
				540					
						570			
			SCANIA (TÜRKİYE)						
⊗ 4263.20.00	GMF420K		SCANIA	532	533	534			
				535	536	537			
				538	539	540			
						570			
			SCANIA (TÜRKİYE)						
⊗ 4265.30.00	420GSZ	1 3/4"-10Z	IVECO	117	118	119			
				121	123	124			
				125					
⊗ 4266.30.00	420/210GSZ	2"-10Z	ASTRA	1					
			MERCEDES-BENZ	402	403	404			
				417	418				
⊗ 4268.20.00	GMF420K		IVECO	90					
⊗ 4268.30.00	420GSZ	1 3/4"-10Z	DAF	40					
			IVECO	124	125	408			
			IVECO	71	88	89			
				90	91	92			
				93	94	95			
				112	117	118			
				119	120	121			
				122	123				
						IVECO-FIAT (TÜRKİYE)	126		
						MAGIRUS-DEUTZ	142	143	145
							146	147	148
						MAN	260	273	
			⊗ 4269.20.00	GMF420K		ENASA	41		
⊗ 4272.30.00	420WGSZ	1 3/4"-10Z	MAGIRUS-DEUTZ	141	144	147			
⊗ 4277.20.00	GFX420KR		IVECO-FIAT (TÜRKİYE)	126					
			MAGIRUS-DEUTZ	148					
⊗ 4278.20.00	GFX420KR		IVECO	89	90	92			
				93	94	95			
				112	117	118			
				119	120	121			
				122	123	124			
						125			

Arithmetical list

Reference	Parameter	Hub profile	Manufacturer	Page
⊗ 4278.30.00	420W2GSZ	1 3/4"-10Z	DAF	15 19
⊗ 4281.30.00	420WGVZ	1 3/4"-10Z	MAN	261 264 265 266 267 268 270 272 274 275 276 277
			MAN (TÜRKİYE)	278
⊗ 4283.30.00	420WGSZ	36X45-10Z	MAN	256 260 263 266 269 271
			ÖSTERREICHISCHE AUTOMOBILFABRIK (ÖAF)	464 465 466
			RENAULT TRUCKS	526 527
⊗ 4286.30.00	420WGTZ	2"-10N	MAN	177 178 179 180 181 182 183 184 186 199 261 262 267 268 269 271 272 273 275 276 277
⊗ 4287.30.00	420GVZ	1 3/4"-10Z	DAF	15 16 17 18 34
			MERCEDES-BENZ	403 417 418 427 440 441
⊗ 4289.30.00	420GSZ	1 3/4"-10Z	IVECO	88 89
			MERCEDES-BENZ	400 401 413 414 415 423 424 425 437
⊗ 4290.30.00	420GSZ	1 3/4"-10Z	MERCEDES-BENZ	384 385 386 392 393 394 395 400 413 414 423
⊗ 4291.30.00	420GSZ	1 3/4"-10N	ENASA	41
			RENAULT TRUCKS	482 483 484 505 506 507
⊗ 4292.30.00	420GSZ	2"-10N	ENASA	41
⊗ 4293.30.00	420GSZ	42x52-10	KAROSA	130
			LIAZ	131
			TATRA	582
⊗ 4296.20.00	GF420		STEYR	579 580
⊗ 4297.30.00	420GSZ	1 3/4"-10Z	ASTRA	1
			MERCEDES-BENZ	413 424
			RENAULT TRUCKS	526 527
⊗ 4298.20.00	GF420		IVECO	90 91 120 125
			MAGIRUS-DEUTZ	139 141 142 143 144 146 147 412
			MERCEDES-BENZ	426 429 438
⊗ 4298.30.00	420GSZ	1 3/4"-10Z	MERCEDES-BENZ	402 415 416 420 426 437
			RENAULT TRUCKS	473
⊗ 4299.20.00	GFX420K		IVECO	119 120 123
			MAGIRUS-DEUTZ	145 147 148
⊗ 4299.30.00	420GSZ	2"-10	IVECO	124 126
			MAGIRUS-DEUTZ	148
⊗ 4300.20.00	MFZ430		ENASA	41
			IVECO	95
			MERCEDES (TÜRKİYE)	282
⊗ 4300.30.00	430GTZ	2"-10Z	KAMAZ	129
			SISU	571
⊗ 4300.50.03			DAF	24 25

Arithmetical list

Reference	Parameter	Hub profile	Manufacturer	Page			
4300.50.09			SCANIA	541 542 543			
				544 545 546			
				547 548 549			
				550 551 552			
				553 554 555			
4300.90.01			MERCEDES-BENZ	407 410 411			
				412 417 421			
				422 430 431			
				433			
			MERCEDES-BENZ	434 435 436			
				438 439 440			
				441 442 443			
				444 445 446			
				447 448 449			
				452 453 454			
				455 456 457			
458 459 460							
4300.90.02			IVECO	72 73 75			
				77 79 80			
				81 82 111			
				122 124			
4300.90.03			DAF	23 24 25			
				26 27 28			
				30 31 35			
				37 38			
4300.90.04			ASTRA	1 2 3			
				4			
			IVECO	71 72 73			
				74 75 76			
				78 79 80			
				81 82 86			
				96 99 102			
				103 106 109			
				110 111 120			
				122 124			
4300.90.05			MAN	151 152 153			
				154 155 156			
				157 158 159			
				160 165 166			
				167 168 169			
				170 171 172			
				173 174 175			
				184 185 198			
				261 267 276			
				277			
			ÖSTERREICHISCHE AUTOMOBILFABRIK (ÖAF)	464 465 466			
				467 468			
			STEYR	578			
			4300.90.051			MAN	164 165 176
							177 178 179
180 181 182							
183 184							
4300.90.06	⊕		IVECO	110 111 112			
				121 122 123			
4300.90.07			MERCEDES-BENZ	410 411 412			
				419 422 431			
				434 435 440			
				441 442 443			
				444 448 449			
				450 454 455			
				456 459 460			
4300.90.09			SCANIA	541 542 543			
				544 545 546			
				547 548 549			
				550 551 552			
				553 554 555			
			VOLVO	590			
4300.90.10	⊕		SCANIA	534 535 536			
				537 538 539			
				540			

Arithmetical list

Reference	Parameter	Hub profile	Manufacturer	Page						
4300.90.101			MAN	207	208	210				
				211	212	213				
				221	222	223				
				224	226	238				
				239	240	241				
244	247	249								
4300.90.102			MAN	207	208	210				
				211	212	213				
				221	222	223				
				224	226	227				
				238	239	240				
				241	242	243				
				244	246	247				
				249	250	251				
252										
4300.90.103			MAN	207	208	210				
				211	212	213				
				221	222	223				
				224	226	238				
239	244									
4300.90.104			MAN	207	208	210				
				211	212	213				
				221	222	223				
224	226									
4300.90.105			MAN	207	208	210				
				211	212	213				
				221	222	223				
				224	226	227				
				238	239	242				
				243	244	246				
250	251	252								
4300.90.106	⊕		VOLVO	590	592	608				
				609	610	611				
				613	614	615				
				616	620	622				
				624						
4300.90.109			ASTRA	5						
			IVECO	97	100	102				
				103	104	106				
				107	108					
4300.90.11	⊕		SCANIA	535	536	537				
				538	539	540				
4300.90.110			ASTRA	5						
			IVECO	103	106	107				
				108	110					
4300.90.111			SCANIA	556	557	558				
				559	560	561				
				562	563	564				
				565	566	567				
				568	569					
4300.90.112			SCANIA	556	557	558				
				559	560	561				
				562	563	564				
				565	566	567				
				568	569					
4300.90.113			SCANIA	541	542	543				
				544	545	546				
				547	548	549				
				550	551	552				
				553	554	555				
				556	557	558				
				559	560	561				
				562	563	564				
				565	566	567				
				568	569					
				4300.90.114			SCANIA	541	542	543
								544	545	546
								547	548	549
550	551	552								
553	554	555								
4300.90.116			RENAULT TRUCKS	502	522	523				
4300.90.117			RENAULT TRUCKS	495	500	502				

Arithmetical list

Reference	Parameter	Hub profile	Manufacturer	Page
4300.90.118	⊕		VOLVO	590 608 609
				610 611 613
				615 620 622
				624
4300.90.119			RENAULT TRUCKS	499
4300.90.12			STEYR	572
4300.90.128			VOLVO	596 632
4300.90.129	⊕		RENAULT TRUCKS	477 478 481
				487 488 528
				529
			VOLVO	591 593 594
				607 608 613
				616 621 625
				626 627 628
629 630				
4300.90.13			MAN	204 206 210
				212 213 225
				226 227 233
				234 235 236
			237 240 241	
			247 248 249	
			STEYR	572
			4300.90.14	
4300.90.15	⊕		MERCEDES (TÜRKIYE) MERCEDES-BENZ	281
				282 283 284
				286 287 288
				289 290 291
				292 293 294
				295 297 298
				299 300 301
				302 303 304
				306 307 308
				309 340 341
				344 345
4300.90.16	⊕		VOLVO	595 609 611
				616 617 618
				619 632
4300.90.17			DAF	33
			RENAULT TRUCKS	495 496 517
4300.90.171			DAF	26 32
4300.90.175			IVECO	99 100 101
				103 104
4300.90.176			ASTRA	2 3 4
			IVECO	71 72 73
				74 75 76
				78 79 80
				81 82 86
				99 102 103
106 109 110				
4300.90.177			IVECO	83 86
4300.90.178			IVECO	100 101 102
				104
4300.90.179			IVECO	102 103
4300.90.18			MERCEDES-BENZ	384 385 386
				392 393 406
				409 414 415
				420 428 429
				431 432 433
4300.90.181	■		DAF	22 23 24
				25 26 27
				30 31 33
				37 38
4300.90.188	■		DAF	24 26 32
				33 39
4300.90.189	■		DAF	24 26 27
				28 29 32
				33 39

Arithmetical list

Reference	Parameter	Hub profile	Manufacturer	Page
4300.90.20			MAN	204 206 210
				212 213 225
			STEYR	226
				572
4300.90.202			MAN	252
4300.90.21	⊕		VOLVO	583 603 604
				616 617 631
				633
4300.90.212			SCANIA	556 557 558
				559 560 561
				562 563 564
				565 566 567
				568 569
4300.90.213			SCANIA	556 557 558
				559 560 561
				562 563 564
				565 566 567
				568 569
4300.90.214			SCANIA	556 557 558
				559 560 561
				562 563 564
				565 566 567
				568 569
4300.90.22	⊕		VOLVO	589 603
4300.90.222	⊕		SCANIA	556 557 558
				559 560 561
				562 563 564
				565 566 567
				568 569
4300.90.23	⊕		RENAULT TRUCKS	519
			VOLVO	596
4300.90.232			SCANIA	556 557 558
				559 560 561
				562 563 564
				565 566 567
				568 569
4300.90.24	⊕		SCANIA	535 536 537
				538 539 540
4300.90.28			MERCEDES-BENZ	407 416 429
				438 439
4300.90.29			MERCEDES-BENZ	393 394 395
				407 409 410
				420 428 431
				432 433
4300.90.30			MERCEDES-BENZ	385 386 394
				395 402 406
				407 414 415
				416 418 421
				429 430 432
				438 439 443
				444 446 452
				453 454 455
				456 458 459
				460
4300.90.33	⊕		VOLVO	583 584 594
				595 604 618
			VOLVO (TÜRKİYE)	619 632
				633
4300.90.334		10	DAF	28
4300.90.34	⊕		VOLVO	594 595 596
				616 618 619
4300.90.349			RENAULT TRUCKS	474 475 496
				500 502 503
				504
4300.90.35	⊕		VOLVO	595 609 611
				617 618 619
			VOLVO (TÜRKİYE)	632
				634

Arithmetical list

Reference	Parameter	Hub profile	Manufacturer	Page			
4300.90.350	⊕		RENAULT TRUCKS	474	475	479	
				504	505	506	
				507	508	509	
4300.90.36	⊕		IVECO	93	110	111	
4300.90.37	⊕		IVECO	110	111	112	
				120	121	122	
4300.90.38			RENAULT TRUCKS	497			
4300.90.381	⊕		MERCEDES-BENZ	285	286	288	
				289	291	292	
				293	296	297	
				298	303	304	
				305	307	308	
4300.90.382	⊕		MERCEDES-BENZ	285	286	289	
				292	293	296	
4300.90.39			RENAULT TRUCKS	489	491	492	
				493	495	519	
				520			
4300.90.40			RENAULT TRUCKS	490	491	492	
				496	497	500	
				501	517	518	
				519	520		
4300.90.41			RENAULT TRUCKS	490	518	519	
4300.90.42	⊕		IVECO	92	93		
4300.90.44			KAMAZ	127			
			KAMAZ	128	129		
4300.90.46	⊕		RENAULT TRUCKS	496	500	503	
4300.90.47	⊕		RENAULT TRUCKS	474	475		
4300.90.48	⊕		RENAULT TRUCKS	474	475	478	
				479	504	505	
				506	507	508	
				509			
4300.90.49			MAN	151	152	153	
				154	155	156	
				157	158	159	
				160	164	165	
				171	172	173	
				175	176	178	
				180	181	184	
				198	199	270	
				ÖSTERREICHISCHE AUTOMOBILFABRIK (ÖAF)	464	465	466
				467			
4300.90.50	⊕		MERCEDES-BENZ	283	287	289	
				290	293	295	
4300.90.51			SCANIA	570			
			SCANIA (TÜRKİYE)	571			
4300.90.52			MAN	205	209	213	
				215	216	217	
				218	219	220	
				227	233	234	
				235	236	237	
				245	246	247	
				248	249		
4300.90.53			STEYR	572			
4300.90.54			RENAULT TRUCKS	493			
4300.90.55			RENAULT TRUCKS	489	490	491	
				492	493		

Arithmetical list

Reference	Parameter	Hub profile	Manufacturer	Page	
4300.90.56			MAN	204 205 206	
				209 210 213	
				215 216 217	
				218 219 220	
				225 226 227	
				233 234 235	
				236 237 240	
				241 245 246	
				247 248 249	
					STEYR
4300.90.60			RENAULT TRUCKS	489 490 491	
				492 493 517	
				518 520	
4300.90.61	⊕		RENAULT TRUCKS	490 491 492	
				496 497 500	
				501 517 518	
				519 520	
4300.90.62	⊕		RENAULT TRUCKS	498 499	
				VOLVO	595 618 619
4300.90.63	⊕		RENAULT TRUCKS	498 499	
				VOLVO	596 632
4300.90.64	⊕		VOLVO	596 632	
4300.90.65			KAMAZ	127	
				KAMAZ	128 129 130
4300.90.68			ASTRA	3	
				IVECO	97 98 99
					100 101 102
					103 104 105
106					
4300.90.69			DAF	24 25 32	
				33 39 40	
4300.90.72			DAF	24 32 33	
				34 39 40	
4300.90.74			RENAULT TRUCKS	489	
4300.90.75	⊕		RENAULT TRUCKS	505 506 507	
				509	
4300.90.76	⊕		VOLVO	583 603 604	
4300.90.78	⊕		MERCEDES-BENZ	331 332 334	
				339 341	
4300.90.89			DAF	24 28 29	
				36	
4300.90.90	⊕		MERCEDES-BENZ	282 283 284	
				286 287 288	
				289 290 291	
				292 293 294	
				295 297 298	
				299 300 301	
				302 303 304	
				306 307 308	
				309 339 340	
				341 344 345	
4300.90.91			RENAULT TRUCKS	491 493 494	
				499 521 522	
				523	
4300.90.94			ASTRA	3	
				IVECO	98 100 101
					102 103 105
					110
4300.90.97			DAF	38	
4300.90.98			RENAULT TRUCKS	521	
4300.90.99			RENAULT TRUCKS	474 475 496	
				497 500 501	
				502 503 504	

Arithmetical list

Reference	Parameter	Hub profile	Manufacturer	Page			
4301.20.00	MFZ430		ASTRA	1	2	3	
				4			
			DAF	23	24	25	
				26	27	28	
				29	30	31	
				32	33	34	
				35	36	37	
				38	39	40	
			IVECO	124	409		
			IVECO	71	72	73	
				74	75	76	
				77	78	79	
				80	81	82	
				86	96	99	
				102	103	106	
				109	110	111	
				120	122	124	
			IVECO-FIAT (TÜRKİYE)	126			
			KAMAZ	128	129		
			MAN	151	152	153	
				154	155	156	
				157	158	159	
				160	164	165	
				166	167	168	
				169	170	171	
				172	173	174	
				175	176	177	
				178	179	180	
				181	182	183	
				184	185	198	
				199	230	232	
				261	267	270	
	276	277					
MAN (TÜRKİYE)	278						
MAZ	279	280					
ÖSTERREICHISCHE AUTOMOBILFABRIK (ÖAF)	464	465	466				
	467	468					
RENAULT (TÜRKİYE)	473						
STEYR	576	577	578				
YaMZ	634						
ZIL	635						
4302.30.00	430GTZ	41X45-22Z	SCANIA	534	535	536	
				537	538	539	
				540			
4303.20.00	MFZ430		ASTRA	3			
			DAF	24	25	33	
				38			
			DAF (TÜRKİYE)	41			
			IVECO	97	98	99	
				100	101	102	
				103	104	105	
	106	110					
	SISU	571					

Arithmetical list

Reference	Parameter	Hub profile	Manufacturer	Page	
4304.20.00	MFZ430		BMC (TÜRKİYE)	6 7	
			KAMAZ	127	
			KAMAZ	128 129 130	
			MERCEDES (TÜRKİYE)	282	
			MERCEDES-BENZ	384 385 386	
				392 393 406	
				407 409 410	
				411 412 414	
				415 417 420	
				421 422 428	
				429 432 436	
				439 440 442	
				443 444 445	
				446 447 448	
				449 452 453	
				454 455 456	
	457 458 459				
	460				
4304.26.00	MFZ430		VOLVO	594 604 617 618 619	
4304.30.00	430WGTZ	1 3/4"-10Z	MERCEDES-BENZ	385 386 394	
				395 402 406	
				407 414 415	
				416 417 418	
				421 429 430	
				432 438 439	
				443 444 446	
				452 453 454	
				455 456 458	
				459 460	
4305.20.00	MFZ430		MERCEDES-BENZ	385 386 393	
				394 395 402	
				406 407 409	
				410 414 415	
				416 418 420	
				421 428 429	
				430 432 438	
				439 443 444	
				446 452 453	
				454 455 456	
				458 459 460	
					499
4305.30.00	430W2GTZ	2"-10Z	MAN	153 225	
			MAZ	279 280	
			MERCEDES (TÜRKİYE)	282	
			MERCEDES-BENZ	408	
			RENAULT TRUCKS	491 493 498 499	
			STEYR	576 577 578	
			YaMZ	634	
4306.30.00	430WGTZ	2"-10Z	MAN	227	
			MAN (TÜRKİYE)	278 279	
			MERCEDES (TÜRKİYE)	282	
			MERCEDES-BENZ	409	
			RENAULT (TÜRKİYE)	472 473	
			RENAULT TRUCKS	490 499 518 519	
4307.20.00	MFZ430		MERCEDES-BENZ	408 410 411	
				412 419 422	
				431 434 435	
				440 441 442	
				443 444 448	
				449 450 454	
				455 456 459	
				460	
4308.20.00	MFZ430		BMC (TÜRKİYE)	7	

Arithmetical list

Reference	Parameter	Hub profile	Manufacturer	Page				
⊗ 4309.26.00	●	MFZ430	IVECO	92 93 110				
				111 112 119				
				120 121 122				
				123 125				
				MAGIRUS-DEUTZ 148				
⊗ 4309.30.00	430WGVZ	55,75x50-20Z	RENAULT TRUCKS	473 529				
⊗ 4310.30.00	430WGVZ	2"-10Z	ENASA	41				
⊗ 4310.60.00	⊕	MFZ430	IVECO	110 111 112				
				119 120 121				
				122 123 125				
				MAGIRUS-DEUTZ 148				
				⊗ 43100.20.00	■**	MFZ430E	DAF	22 23 24
25 26 27								
28 29 30								
31 32 33								
37 38 39								
⊗ 43104.20.00	MFZ430		DAF	28				
⊗ 4311.20.00		MFZ430	DAF	33				
				RENAULT (TÜRKİYE) 472				
				RENAULT TRUCKS 473 489 490				
				491 492 493				
				494 495 496				
				497 499 500				
				501 517 518				
				519 520 521				
				522 523				
				⊗ 4311.26.00	●	MFZ430	RENAULT TRUCKS	474 475 478
				496 497 500				
				501 502 503				
				504				
⊗ 4311.30.00		430W2GTZ 50X55-20Z	RENAULT (TÜRKİYE)	472				
				RENAULT TRUCKS 473 474 475				
				478 479 482				
				483 484 490				
				491 492 495				
				496 497 498				
				500 501 502				
				503 504 505				
				506 507 508				
				509 517 518				
				519 520 523				
				524 525				
				⊗ 4312.30.00		430W2GTZ 1 3/4"-10Z	MERCEDES (TÜRKİYE)	282
RENAULT (TÜRKİYE) 473								
RENAULT TRUCKS 474 475 489								
490 491 492								
493 505 507								
517 518 520								
⊗ 4313.20.00		MFZ430	SCANIA	534 535 536				
				537 538 539				
				540 541 542				
				543 544 545				
				546 547 548				
				549 550 551				
				552 553 554				
				555 570				
				SCANIA (TÜRKİYE) 570 571				
				⊗ 4313.26.00		MFZ430	SCANIA	534 535 536
537 538 539								
540 541 542								
543 544 545								
546 547 548								
549 550 551								
552 553 554								
555								
⊗ 4313.30.00		430WGTZ 2"-10Z	RENAULT TRUCKS					489 491 492
								493 495 519
				520				

Arithmetical list

Reference	Parameter	Hub profile	Manufacturer	Page	
⊗ 43134.30.00	430WGTZ	2" -10N	DAF	24 26 27	
				28 29 32	
				33 39	
⊗ 4314.30.00	430WGTZ	1 3/4"-10Z	MAN	198	
⊗ 4316.30.00	430WGTZ	1 3/4"-10Z	KAMAZ	127	
			KAMAZ	128 129	
			MAZ	280	
			MERCEDES-BENZ	384 385 386	
				392 393 406	
				409 414 415	
			420 428 429		
			431 432 433		
⊗ 4317.30.00	17" 430WGTZ	1 3/4 10N	BMC (TÜRKİYE)	6 7	
⊗ 4318.30.00	430WGTZ	45X50-18Z	MERCEDES (TÜRKİYE)	281 282	
			MERCEDES-BENZ	282 283 284	
				286 287 288	
				289 290 291	
				292 293 294	
				295 297 298	
				299 300 301	
				302 303 304	
				306 307 308	
				309 340 341	
				344 345	
			⊗ 4318.60.00	⊕ MFZ430	
	290 293 295				
	299 300 301				
	331 332 334				
	339 341 345				
	346				
⊗ 4319.20.00	MFZ430		MAN	204 205 206	
				209 210 212	
				213 215 216	
				217 218 219	
				220 225 226	
				227 233 234	
				235 236 237	
				240 241 245	
				246 247 248	
				249	
				MAN (TÜRKİYE)	279
				STEYR	572
			⊗ 4321.30.00	430 WGTZ	41X45X22N
⊗ 4323.30.00	430WGTZ	2" -10Z	VOLVO	583 603 604	
				616 617 631	
				633	
⊗ 4325.30.00	430WGTZ	46X50-24Z	SCANIA	570	
			VOLVO	595 609 611	
				616 617 618	
				619 632	
				VOLVO (TÜRKİYE)	634
⊗ 4326.30.00	430WGTZ	2"-10Z	ASTRA	1 2 3	
				4	
			IVECO	71 72 73	
				74 75 76	
				78 79 80	
				81 82 86	
				92 93 95	
				96 99 102	
				103 106 109	
				110 111 112	
				119 120 121	
				122 123 124	
				IVECO-FIAT (TÜRKİYE)	126
				RENAULT TRUCKS	497

Arithmetical list

Reference	Parameter	Hub profile	Manufacturer	Page					
⊗ 4327.30.00	430GTZ	2"-10Z	IVECO	72	73	75			
				77	79	80			
				81	82	83			
				86	93	110			
				111	112	120			
				121	122	123			
				124					
					IVECO-FIAT (TÜRKİYE)	126			
					MAGIRUS-DEUTZ	148			
					RENAULT TRUCKS	473	478	490	
						491	496	500	
						503	505	506	
						507	509		
⊗ 4328.20.00	MFZ430		SCANIA	541	542	543			
				544	545	546			
				547	548	549			
				550	551	552			
				553	554	555			
					SCANIA (TÜRKİYE)	570			
	VOLVO	590							
⊗ 4328.30.00	17" 430WGTZ	2" SAE - 10N	BMC (TÜRKİYE)	7					
⊗ 4329.30.00	430WGTZ.	46x50-24Z	RENAULT TRUCKS	491	494	498			
				499	520	521			
				522	523				
					VOLVO	589	595	608	
						609	610	611	
						618	619	620	
		632							
⊗ 4329.60.00	⊕ MFZ430		MERCEDES (TÜRKİYE)	281	282				
					MERCEDES-BENZ	282	283	284	
						285	286	287	
						288	289	290	
						291	292	293	
						294	295	296	
						297	298	299	
						300	301	302	
						303	304	305	
						306	307	308	
						309	340	341	
						344	345		
				⊗ 4330.60.00	⊕ MFZ430		SCANIA	534	535
537	538	539							
540									
⊗ 4331.30.00	430WGTZ	2"-10Z	ASTRA	3					
				IVECO	97	98	99		
					100	101	102		
					103	104	105		
					106	110			
						VOLVO	583	584	594
							595	596	604
							616	618	619
							632		
						VOLVO (TÜRKİYE)	633		
⊗ 4331.60.00	⊕ MFZ430		SCANIA	535	536	537			
				538	539	540			
⊗ 4332.30.00	430GTZ	2"-10N	DAF	24	25	32			
				33	39	40			
					KAMAZ	127			
					KAMAZ	128	129	130	
⊗ 4332.60.00	⊕ MFZ430		VOLVO	583	584	589			
				594	595	603			
				604	608	609			
				611	616	617			
				618	619	631			
				632	633				
					VOLVO (TÜRKİYE)	633			

Arithmetical list

Reference	Parameter	Hub profile	Manufacturer	Page	
⊗ 4333.30.00	430WGTZ	46X50-24Z	SCANIA	535 536 537	
				538 539 540	
				541 542 543	
				544 545 546	
				547 548 549	
			550 551 552		
			553 554 555		
			570		
			SCANIA (TÜRKİYE)	570 571	
			VOLVO	590	
⊗ 4333.60.00 ⊕	MFZ430		VOLVO	594 595 596	
				608 609 611	
				616 617 618	
				619 632	
				VOLVO (TÜRKİYE)	634
⊗ 4334.30.00	430GTZ	2"-10Z	DAF	22 23 24	
				25 26 27	
				28 30 31	
				33 35 37	
			38		
			DAF (TÜRKİYE)	41	
			IVECO	100 101 102	
			104		
⊗ 4334.60.00 ⊕	MFZ430		IVECO	92 93 110	
				111 121 122	
				MAGIRUS-DEUTZ	148
⊗ 4335.30.00	430GTZ	1 3/4"-10Z	KAMAZ	128 130	
			VOLVO	589 603	
⊗ 4335.60.00 ⊕	MFZ430		RENAULT TRUCKS	473 474 475	
				478 479 496	
				500 503 504	
				505 506 507	
				508 509 529	
⊗ 4336.30.00	430GTZ	2"-10N	VOLVO	583 603 604	
⊗ 4336.60.00 ⊕	MFZ430		RENAULT TRUCKS	498 499	
			VOLVO	595 618 619	
				632	
⊗ 4338.30.00	430WGTZ	2"- 10N	DAF	24 26 28	
				29 32 33	
				34 36 39	
				40	
⊗ 4339.20.00	MFZ430		STEYR	572	
⊗ 4339.30.00	430WGTZ	1 3/4" -10N	IVECO	98 99 100	
				101 103 104	
				105	
⊗ 4340.60.00	MFZ430		MERCEDES-BENZ	282 283 284	
				286 287 288	
				289 290 291	
				292 293 294	
				295 297 298	
				299 300 301	
				302 303 304	
				306 307 308	
				309 339 340	
				341 344 345	
⊗ 4341.20.00	MFZ430		DAF	19	
			IVECO	83 86	
⊗ 4342.30.00	430GTZ	50x55-20N	RENAULT TRUCKS	473 474 475	
				482 483 484	
				485 505 506	
				507 529 530	
⊗ 4343.30.00	430GTZ	2"-10N	RENAULT TRUCKS	473 474 479	
				482 483 484	
				485 496 502	
				503 504 505	
				506 507 523	
				524 525 529	

Arithmetical list

Reference	Parameter	Hub profile	Manufacturer	Page	
⊗ 4346.30.00	430WGTZ	2" -10N	DAF	33	
			MAN	151 152 153	
				154 155 156	
				157 158 159	
				160 164 165	
				166 167 168	
				169 170 171	
				172 173 174	
				175 176 178	
				180 181 184	
				185 198 199	
			MERCEDES-BENZ	204 205 206	
				209 210 212	
				213 215 216	
				217 218 219	
				220 225 226	
				227 233 234	
				235 236 237	
				393 394 395	
				407 409 410	
				411 412 416	
			ÖSTERREICHISCHE AUTOMOBILFABRIK (ÖAF)	417 419 420	
				421 422 428	
				429 430 432	
				436 439 440	
				442 443 444	
				445 446 447	
				448 449 450	
				452 453 454	
				455 456 457	
				458 459 460	
			RENAULT TRUCKS	464 465 466	
				467 468	
489 490 491					
492 493 494					
495 496 499					
517 519 521					
522 523					
STEYR	572 576 577				
	578				
⊗ 43460.30.00	430WGTZ	2" -10N		MAN	152 164 165
				176 178 184	
⊗ 43461.30.00	430WGTZ	2" -10N	KAMAZ	129	
			MAN	164 165 176	
				177 178 179	
				180 181 182	
				183 184 205	
				206 207 209	
				210 211 212	
				213 215 216	
				217 218 219	
				220 221 222	
				223 224 225	
			226 227 233		
			234 235 236		
			237 238 239		
			240 241 242		
			243 244 245		
			246 247 248		
			249 250 251		
			ÖSTERREICHISCHE AUTOMOBILFABRIK (ÖAF)	465	
				RENAULT TRUCKS	489 491 492
					493
			SISU	571	
			⊗ 4349.60.00	MFZ430	
292 293 296					
297 303 305					
307 309					

Arithmetical list

Reference	Parameter	Hub profile	Manufacturer	Page		
⊗ 4350.30.00	430WGTZ	45x50-18N	MERCEDES-BENZ	282	283	284
				286	287	288
				289	290	291
				292	293	294
				295	297	298
				299	300	301
				302	303	304
				306	307	308
				309	339	340
				341	344	345
				⊗ 4351.30.00	430WGTZ	45x50-18N
289	291	292				
293	296	297				
298	303	304				
305	307	308				
309	331	332				
⊗ 4352.30.00	430WGTZ	45x50-18N	MERCEDES-BENZ	285	286	289
				292	293	296
				297	303	305
				307	309	
⊗ 4356.30.00	430WGTZ	1 3/4"-10N	MAN	230	232	
⊗ 4366.30.00	430WGTZ	1 3/4"-10N	DAF	29		
⊗ 4371.20.00	MFZ430		DAF	24	25	26
				27	28	29
				32	33	36
				39		
⊗ 4378.20.00	MFZ430		SCANIA	541	542	543
				544	545	546
				547	548	549
				550	551	552
				553	554	555
⊗ 4380.30.00	430WGTZ	2"-10N	RENAULT TRUCKS	519		
			VOLVO	596		
⊗ 4382.60.00	⊕ MFZ430		RENAULT TRUCKS	477	478	481
				487	488	528
				529		
				590	591	592
				593	594	607
			VOLVO	608	609	610
				611	613	614
				615	616	620
				621	622	624
				625	626	627
				628	629	630
⊗ 4383.60.00	⊕ MFZ430		RENAULT TRUCKS	519		
			VOLVO	596	632	
⊗ 4384.60.00	MFZ430		VOLVO	590	607	608
				609	610	611
				613	615	620
				621	622	624
				626	627	
⊗ 4385.60.00	MFZ430		RENAULT TRUCKS	498	499	
			VOLVO	596	632	
⊗ 4386.20.00	MFZ430		MAN	207	208	210
				211	212	213
				221	222	223
				224	226	227
				238	239	240
				241	242	243
				244	246	247
				249	250	251
				252		

Arithmetical list

Reference	Parameter	Hub profile	Manufacturer	Page			
⊗ 4386.30.00	430WGTZ	2"-10N	MAN	207	208	210	
				211	212	213	
				221	222	223	
				224	226	227	
				238	239	240	
				241	242	243	
				244	246	247	
				249	250	251	
				252			
				STEYR	572		
				⊗ 4387.20.00	MFZ430		MAN
⊗ 4387.30.00	430WGTZ	2"-10N	MAN	252			
⊗ 4389.30.00	430WGTZ	46x50-24N	RENAULT TRUCKS	498	499		
				VOLVO	590	592	596
					608	609	610
					611	613	614
					615	616	620
					622	624	632
⊗ 4390.20.00	MFZ430		ASTRA	5			
				IVECO	97	100	102
					103	104	106
					107	108	110
				RENAULT TRUCKS	499		
⊗ 4390.30.00	430WGTZ	2" -10N	ASTRA	5			
				IVECO	97	100	102
					103	104	106
					107	108	110
⊗ 4392.30.00	430WGTZ	46x50-24N	SCANIA	556	557	558	
				559	560	561	
				562	563	564	
				565	566	567	
				568	569		
⊗ 4393.20.00	MFZ430		SCANIA	541	542	543	
				544	545	546	
				547	548	549	
				550	551	552	
				553	554	555	
				556	557	558	
				559	560	561	
				562	563	564	
				565	566	567	
				568	569		
⊗ 4393.30.00	430WGTZ	46x50-24N	SCANIA	541	542	543	
				544	545	546	
				547	548	549	
				550	551	552	
				553	554	555	
				556	557	558	
				559	560	561	
				562	563	564	
				565	566	567	
				568	569		
⊗ 4394.20.00	MFZ430		SCANIA	556	557	558	
				559	560	561	
				562	563	564	
				565	566	567	
				568	569		
⊗ 4394.30.00	430WGTZ	46x50-24N	SCANIA	556	557	558	
				559	560	561	
				562	563	564	
				565	566	567	
				568	569		
⊗ 4395.20.00	MFZ430		RENAULT TRUCKS	495	500	502	
				522	523		

Arithmetical list

Reference	Parameter	Hub profile	Manufacturer	Page		
⊗ 4398.30.00	430WGTZ	46x50-24N	RENAULT TRUCKS	477	478	481
				487	488	493
				494	495	500
				502	520	522
				528	529	
				590	591	592
			VOLVO	593	594	607
				608	609	611
				613	614	615
				616	621	622
				624	625	626
				627	628	629
				630		
⊗ 4399.30.00	430WGTZ	2" -10N	RENAULT TRUCKS	495	499	500
				502	522	523
⊗ 4500.40.00	KZIZ - 3		IVECO	48	49	50
				51	52	53
				54	55	56
				57		
⊗ 4502.40.00	KZI - 1		IVECO	48	49	50
				51	52	53
⊗ 5501.40.00	KZISZ - 3		IVECO	57	58	59
				60	61	63
				64	67	71
			RENAULT TRUCKS	509	510	512
				513	514	515
⊗ 5700.40.00	KZIZ - 3		MERCEDES-BENZ	353	354	355
				370	371	372
				373	374	
⊗ 5800.40.00	KZA - 2		IVECO	113	115	406
			MAGIRUS-DEUTZ	134		
			ZASTAVA	635		
⊗ 5902.40.00	KZA - 4		VOLVO	582	585	587
				589	602	631
⊗ 6200.40.00	KZ - 4		ZASTAVA	635		
⊗ 6300.40.00	KZI - 2		ZASTAVA	635		
⊗ 6301.40.00	KZI - 2		IVECO	115	407	
			IVECO	57		
⊗ 6606.40.00	KFL - 555		TAM	580	581	
⊗ 6901.40.00	KZI - 3		MERCEDES-BENZ	353	367	369
				370	371	372
				373	374	375
				377	378	379
				380	381	382
				383	388	389
				390	391	392
				396	397	398
				408	425	
⊗ 6904.40.00	KZI-3		IVECO	86	87	88
				93		

Arithmetical list

Reference	Parameter	Hub profile	Manufacturer	Page				
⊙ 6905.40.00	KZIS - 3		AVIA	6				
			DAF	8	9	10		
				21				
			IVECO	70	71	115		
				116				
			MAGIRUS-DEUTZ	133				
			MAGIRUS-DEUTZ	134	135	136		
				137	138	141		
				142	144			
			MAN	186	190	191		
				192	193	194		
				195	196	197		
				198	199	254		
				255	256	257		
				259	262			
				MERCEDES-BENZ	381	382		
				RENAULT (TÜRKİYE)	472			
	RENAULT TRUCKS	486	509	510				
		513	530					
	STEYR	573	574					
⊙ 6907.40.00	KZI - 3		MERCEDES-BENZ	388	390	397		
			TAM	580	581			
⊙ 6908.40.00	KZ - 3		MERCEDES-BENZ	367	368	369		
				370	371	372		
				373	374	377		
				378	379	380		
				382	383	390		
				391	397	398		
⊙ 6909.40.00	KZI - 3		IVECO	115				
			MERCEDES-BENZ	353	364	366		
				367	368	369		
				370	371	372		
				373	374	375		
				376	377	378		
				380	382	387		
				390	395	408		
⊙ 6915.40.00	KZI - 4		MERCEDES-BENZ	383	389	396		
				398	399	408		
				409	423			
⊙ 7200.40.00	FKL - 306.770L		TAM	580				
⊙ 7201.40.00	KZI - 3		MAZ	279				
⊙ 7451.40.00	KZIS-4		KAMAZ	127				
			KAMAZ	128				
⊙ 7802.40.00	KZA - 4		VOLVO	582	585	587		
				602	631	632		
⊙ 7903.40.00	KZI-4		IVECO	112	113	114		
				116				
⊙ 7904.40.00	Kzi-3		MAZ	279				
⊙ 7951.40.00	KZIS - 4		DAF	11	12	13		
				14	15	17		
				18	19	20		
				21	22	23		
				24	25	26		
				27	40			
			IVECO	124				
			IVECO	86	123			
			MAGIRUS-DEUTZ	138	139	140		
				142	145	146		
			MAN	199				
			RENAULT TRUCKS	525	526	527		
			STEYR	571	573	578		
				579	580			
			⊙ 8302.40.00	KZI - 4		MERCEDES-BENZ	358	359
⊙ 8401.40.00	KZI - 4,5		TAM	581				

Arithmetical list

Reference	Parameter	Hub profile	Manufacturer	Page									
⊙ 8500.40.00	KZI - 4,5		LIEBHERR	132									
			MERCEDES-BENZ	379 384 385 386 392 393 394 395 399 400 401 402 403 405 412 413 414 415 416 420 421 422 423 424 425 426 427 429									
			MERCEDES-BENZ	429 430 431 432 436 437 438 440 445 446 447 450 451 452 453 458									
			SISU	571									
			TAM	581									
			⊙ 8502.40.00	KZI - 4		MERCEDES-BENZ	393 399 400 401 413 414 419 420 424 425 436						
						⊙ 8503.40.00	KZI - 4,5		MERCEDES-BENZ	414 415 436			
									⊙ 8505.40.00	KZI - 4,5		DAF	10 11 12 15 16 17 18 29 34 35
												FAUN	42 43 44
			KRUPP	131									
			LIEBHERR	132									
			MAGIRUS-DEUTZ	133									
			MAGIRUS-DEUTZ	135 141									
			MAN	193 194 195 196 197 198 252 254 255 256 257 258 259 260 261 262 263 264 265 266 267 268 269 270 271 272 273 274 275 276 277									
			ÖSTERREICHISCHE AUTOMOBILFABRIK (ÖAF)	463 464 465 466 468									
			RENAULT TRUCKS	485									
			⊙ 8508.40.00	KZI - 4,5		IVECO	116						
						STEYR	576 577 579 580						
						ZASTAVA	635						
			⊙ 8509.40.00	KZI - 4,5		MERCEDES-BENZ	379 384 392 399 423						
⊙ 8510.40.00	KZI - 4,5					IVECO	86 90 112 117 118 119 121 122						
			⊙ 8511.40.00	KZI - 4,5		MERCEDES-BENZ	384 385 386 392 393 394 395 401 402 423 425						
						MERCEDES-BENZ	429 430 431 436 437 441						
⊙ 8512.40.00	KZI - 4,5					IVECO	86 117 118 119 120 121 122						
						MAGIRUS-DEUTZ	142 143 145 147 148						

Arithmetical list

Reference	Parameter	Hub profile	Manufacturer	Page		
8513.40.00	KZI - 4,5		MERCEDES-BENZ	402 403 404		
				417 418 421		
				422 426 427		
				430 440 441		
				445 446 450		
				451 454 457		
				458		
8514.40.00	KZI - 4,5		ASTRA	1		
				DAF	7 8 12	
					14 15 16	
					17 19 20	
					27 28 40	
					124 125	
				IVECO	60 62 65	
					67 68 69	
					70 71 88	
					89 90 91	
					92 93 94	
					95 116 117	
					118 119 120	
				Kaelble	121 122 123	
					126 127	
				MAGIRUS-DEUTZ	134 136 137	
					138 139 140	
					141 142 143	
					144 145 146	
					147 148 412	
					MAN	224 228 229
						230 232
				404		
8516.40.00	KZI - 4,5		MAN	260 261 263		
				264 265 266		
				267 268 270		
				271 272 273		
				274 275 276		
				277		
				8520.40.00	KZI - 4,5	
418 419 421						
427 428 431						
438 440 441						
442 443 446						
450 451 452						
453 454 455						
457 458 459						
8525.40.00	KZIS-3		RENAULT TRUCKS	483 485 486		
				506 509 510		
				511 512 513		
				514 515 516		
				530		
8526.40.00	KZI-4		RENAULT TRUCKS	483 515		
8529.40.00	KZI - 4,5		MERCEDES-BENZ	375 381 385		
				388 389 390		
				391 392 396		
				397 398 399		
				404 405 406		
				409 419 420		
				423 428		
8532.40.00	KZI - 4,5		IVECO	117 118 119		
				121 123 124		
				125		
8533.40.00	KZI - 4,5		KAMAZ	127		
				128 129 130		
			MAN	254 255 256		
				257 258 259		
				260 262 263		
				264 266 269		
				270		
			MAZ	280		
			RENAULT TRUCKS	525		

Arithmetical list

Reference	Parameter	Hub profile	Manufacturer	Page		
8535.40.00	KZIZ - 4,5		MAN	151	187	198
				199	200	201
				202	203	204
			RENAULT TRUCKS	224	228	230
				231	232	
				510	517	
STEYR	574	575	576			
	577					
8536.40.00	KZIS-4		MERCEDES-BENZ	372	375	377
				378	381	388
				396		
8537.40.00	KZI-4.5		MAZ	279	280	
8538.40.00	KZI-4,5		MAGIRUS-DEUTZ	142	143	
8539.40.00	KZI-4.5		MAZ	279	280	
8540.40.00	KZIS-4		MERCEDES-BENZ	361	362	363
8541.40.00	KZIS-4		DAF	20		
			IVECO	60		
8542.40.00	KZIS-4		DAF	20	21	22
				28		
			IVECO	98	104	105
8543.40.00	KZIS-4		RENAULT TRUCKS	476	480	481
				516	521	
			VOLVO	588	589	605
			606			
8544.40.00			RENAULT TRUCKS	515		
8601.47.00			MERCEDES-BENZ	310	311	312
				313	314	315
				316	317	318
				319	320	322
				324	326	328
				330	333	335
				336	338	339
				343	347	
8602.47.00			MERCEDES-BENZ	312	313	314
				315	317	318
				319	320	322
				324	326	328
				330	333	335
				336	338	339
				343	347	
8603.47.00	HHIS-3		MAN	187	188	190
			MERCEDES-BENZ	310	311	312
				313	314	315
				316	317	318
				319	320	321
				322	323	324
				325	326	327
				328	329	330
				331	332	333
				334	335	336
				337	338	339
				340	341	342
				343	344	347
8604.47.00			MERCEDES-BENZ	312	313	335
				338	339	343
				347		
8631.47.00	HHISZ-4		SCANIA	541	542	543
				544	545	546
				547	548	549
				550	551	552
				553	554	555
			VOLVO	590		
8632.47.00	Fill Medium: Mine		MAN	227	228	229
				230		
8633.47.00	HHISZ-3		MAN	192	230	232

Arithmetical list

Reference	Parameter	Hub profile	Manufacturer	Page					
8641.47.00	PHIS-6/38		RENAULT TRUCKS	477	478	481			
				487	488	491			
				493	494	495			
				500	502	520			
				521	522	523			
							528	529	
						VOLVO	588	589	591
							592	593	594
							598	600	601
							606	607	608
							609	610	611
							613	614	615
							616	620	622
							624	625	628
							629	630	
8653.47.00	HHIS-3		MERCEDES-BENZ	310	311	312			
				313	314	315			
				316	317	318			
				319	320	321			
				322	323	324			
				325	326	327			
				328	329	330			
				331	332	333			
				334	335	336			
				337	338	339			
				340	341	342			
				343	344	347			
					356	357	361		
8900.40.00	KZI - 5		VOLVO	585	587	630			
				631	632				
8901.40.00	KZI - 5		VOLVO	582	583	584			
				585	586	587			
				630	631	632			
8905.40.00	KZIZ - 5		MERCEDES-BENZ	393	394	395			
				407	408	409			
				410	411	412			
				416	417	419			
				420	421	422			
				428	429	430			
				431	432	433			
				435	436	438			
				439	440	442			
				443	444	445			
				446	447	448			
				449	450	452			
				453	454	455			
				456	457	458			
					459	460			

Arithmetical list

Reference	Parameter	Hub profile	Manufacturer	Page			
8916.40.00	KZIZ - 5		DAF	22	23	24	
				25	26	27	
				28	30	31	
				32	33	34	
				35	37	38	
				39	40		
			DAF (TÜRKİYE)	41			
			KAMAZ	127			
			KAMAZ	128	129	130	
			MAN	151	152	153	
				154	155	156	
				157	158	159	
				160	164	165	
				166	167	168	
				169	170	171	
				172	173	174	
				175	176	177	
				178	179	180	
				181	182	183	
				184	185	186	
				198	199	204	
				205	206	207	
				208	209	210	
			211	212	213		
			215	216	217		
			218	219	220		
			MAN (TÜRKİYE)	278	279		
			MAZ	279	280		
			MERCEDES-BENZ	435			
			ÖSTERREICHISCHE AUTOMOBILFABRIK (ÖAF)	464	465	466	
				467	468		
			SISU	571			
			STEYR	572	576	577	
578							
ZIL	635						
8917.40.00	KZIZ - 5		MERCEDES-BENZ	384	385	386	
				392	393	394	
				395	402	406	
				407	409	414	
				415	416	417	
				418	420	421	
				428	429		
				MERCEDES-BENZ	430	431	432
					433	434	435
					438	439	441
					443	444	446
					452	453	454
					455	456	458
					459	460	
				8918.40.00	KZISZ - 5		MERCEDES (TÜRKİYE)

Arithmetical list

Reference	Parameter	Hub profile	Manufacturer	Page		
8919.40.00	KZISZ - 5		ASTRA	1	2	3
				4	5	
			DAF	33		
			IVECO	65	66	67
				71	72	73
				74	75	76
				77	78	79
				80	81	82
				83	84	85
				86	95	96
				97	98	99
				100	101	102
				103	104	105
				106	107	108
				109	110	111
			120	122	124	
			IVECO-FIAT (TÜRKİYE)	126		
			MAN	204	205	206
				207	208	209
				210	211	212
				213	221	222
				223	224	225
				226	227	228
				229	230	231
				232	233	234
				235	236	237
				238	239	240
				241	242	243
				244	247	248
249	250	251				
MAN (TÜRKİYE)	279					
RENAULT (TÜRKİYE)	472					
RENAULT TRUCKS	495	496	517			
	518	519				
STEYR	572					
8922.40.00	KZISZ-5		MERCEDES-BENZ	442		
8923.40.00	KZIZ - 5		SCANIA	535		
8923.46.00	KZIZ-5		SCANIA	536	537	538
				539	540	
8924.40.00	KZIZ5		MAGIRUS-DEUTZ	148		
8924.46.00	KZIZ5		IVECO	110	111	112
				119	120	121
				122	123	125
8925.40.00	KZISZ-5		VOLVO	583	594	595
				604	607	608
				621	626	627
8928.40.00	KZIZ - 5		MERCEDES (TÜRKİYE)	281		
			MERCEDES-BENZ	297	408	411
				412	419	422
				436	440	441
				442	443	444
				445	447	448
				449	450	453
				454	455	456
				460		
				8929.46.00	KZIZ-5	
8930.40.00	KZI/Z-5		IVECO	92	93	110
				111	121	122
			MAGIRUS-DEUTZ	148		
8931.40.00	KZISZ-5		VOLVO (TÜRKİYE)	634		
8932.40.00	KZISZ - 5		RENAULT (TÜRKİYE)	472		
			RENAULT TRUCKS	490	491	492
				496	497	500
				501	517	518
				519	520	

Arithmetical list

Reference	Parameter	Hub profile	Manufacturer	Page
8933.40.00	KZISZ - 5		RENAULT (TÜRKİYE)	472 473
			RENAULT TRUCKS	489 490 491
				492 493 494
				495 498 499
				500 502 518
				519 520 521
				522 523
8934.40.00	KZISZ - 5		SCANIA	541 542 543
				544 545 546
				547 548 549
				550 551 552
				553 554 555
				556 557 558
				559 560 561
				562 563 564
				565 566 567
				568 569 570
				SCANIA (TÜRKİYE)
8935.40.00	KZISZ - 5		KAMAZ	128 130
			MAZ	280
8936.40.00	KZISZ - 5		IVECO	60 70
			RENAULT TRUCKS	473 474 475
				478 479 482
				483 484 485
				495 496 498
				500 502 503
				504 505 506
				507 523 524
	525 529 530			
8936.46.00	KZISZ-5		RENAULT TRUCKS	474 475 496
				500 502 503
				504
8937.40.00	KZISZ-5		RENAULT (TÜRKİYE)	472
			RENAULT TRUCKS	489 490 491
				492 493 496
				497 498 499
				500 501 517
				518 519 520
8938.46.00			RENAULT TRUCKS	474 475 496
				497 500 501
				502 503 504
				529

Arithmetical list

Reference	Parameter	Hub profile	Manufacturer	Page				
8939.40.00	KZISZ - 5		ASTRA	2	3	4		
				5				
			DAF	24	25	26		
				27	28	29		
				32	33	36		
				38	39	40		
			IVECO	71	72	73		
				74	75	76		
				78	79	80		
				81	82	86		
				97	98	99		
				100	101	102		
				103	104	105		
				106	107	108		
				109	110			
			KAMAZ	128				
			MAN	204	205	206		
				207	208	209		
				210	211	212		
				213	215	216		
				217	218	219		
				220	221	222		
				223	224	225		
				226	227	228		
				229	230	231		
				232	233	234		
				235	236	237		
				238	239	240		
				241	242	243		
				244	245	246		
	247	248	249					
	250	251	252					
		STEYR	572					
8940.40.00	KZISZ-5		RENAULT (TÜRKİYE)	472				
			RENAULT TRUCKS	489	490	491		
				492	493			
8941.40.00	KZISZ-5		MAN	149	150	151		
				154	156	157		
				158	159	160		
				161	162	163		
				164	165	204		
				206	207	209		
				210	211	212		
				213	214	225		
				226	227	233		
				234	235	236		
				237	238	239		
				240	241	242		
				243	244	245		
				246	247	248		
				249	250	251		
						252		
					RENAULT (TÜRKİYE)	472		
					RENAULT TRUCKS	489	490	491
						492	493	494
						495	496	498
			499	500	501			
			502	517	518			
			519	520	521			
			522	523				
		STEYR	572	576	578			
8946.46.00	KZIZ-5		VOLVO	583	594	595		
				604	607	608		
8947.40.00	KZISZ-5		MERCEDES-BENZ	286				
8948.40.00	KZIZ-5		SCANIA	557	558	559		
				560	561	562		
				563	564	565		
				566	567	568		
				569				
8949.40.00			RENAULT TRUCKS	502	521	522		
				523				

Arithmetical list

Reference	Parameter	Hub profile	Manufacturer	Page		
8950.40.00	KZIZ-6		DAF	22		
			KAMAZ	129		
			MAN	165	182	205
				206	207	209
				210	211	212
				213	215	216
				217	218	219
				220	221	222
				223	224	225
				226	227	233
				234	235	236
				237	238	239
			240	241	242	
			243	244	245	
			246	247	248	
			249	250	251	
252						
	ÖSTERREICHISCHE AUTOMOBILFABRIK (ÖAF)	465				
8995.40.00	KZIZ-6		RENAULT TRUCKS	489	491	492
				493		
			SISU	571		
9101.40.00	KZI - 5		DAF	15	17	18
				19	27	30
				35	36	37
9302.40.00	KZI-6		MERCEDES-BENZ	406	407	412
				419	422	439
				445	448	449
				455	459	460

Cross reference list

OEM reference	RUEN reference	Parameter
ASKAM CHRYSLER (TÜRKİYE)		
27900	3868.20.00	15" GM380
27901	3884.30.00	15" 380GSZ
32306	3965.30.00	15.5" 395GTZ
32307	3962.20.00	15.5" MF 395
35507T	3593.30.00	350 GSZ

AUWARTER		
0401.424.41	4278.30.00	420W2GSZ
040114800	4255.30.00	420GS
0421.010.00	4244.20.00	GFX420KR
04210100099	4244.20.00	GFX420KR
11009966	4244.20.00	GFX420KR
11009994	4278.30.00	420W2GSZ
20280	4278.30.00	420W2GSZ
20295	4244.20.00	GFX420KR

BMC (TÜRKİYE)		
52RS006175	3962.20.00	15.5" MF 395
52RS006176	3965.30.00	15.5" 395GTZ
52RS011979	4304.20.00	MFZ430
52RS011980	4328.30.00	17" 430WGTZ
52RS014668	4308.20.00	MFZ430
52RS015966	4304.20.00	MFZ430
52RS015967	4317.30.00	17" 430WGTZ
52RS020390	43460.30.00	430WGTZ
57RS308621	3574.20.00	14" MF 350
D001014	3578.30.00	14" 350GSZ
D02967	8935.40.00	KZISZ - 5
D040396	3574.30.00	14" 350GSZ
D040463	3574.20.00	14" MF 350
D060053	3868.20.00	15" GM380
D060113	4300.20.00	MFZ430
D060281	4316.30.00	430WGTZ
D060450	3259.30.00	13" 325GS
D062827	3568.30.00	14" 350GSZ
D063827	3569.30.00	14" 350GSZ
D2122	3592.30.00	14" 350GSZ
D213016222	3594.30.00	14" 350GSZ
HB8104YR	3884.30.00	15" 380GSZ

BOVA		
239354	43460.30.00	430WGTZ
267748	43460.30.00	430WGTZ

CITROËN		
95 632 809	2185.20.00	CP215

CLAAS		
712 611.0	2262.20.00	KS225

DACIA		
11 00 004 720	2045.30.00	200D
11 00 014 731	2045.30.00	200D

DAF		
0291 228	3953.30.00	395WGTZ
0376 491	4256.20.00	GMF420K
066 0306	3878.20.00	GMF380
096 006	3581.20.00	GMF350KR
1140537	4208.30.00	420GS
	43460.30.00	430WGTZ

OEM reference	RUEN reference	Parameter
117 379	4244.30.00	420/210GSZ
117 380	4255.30.00	420GS
117 405	4248.20.00	GFX420KR
117 8753	4226.20.00	GF420KR
1204205	4303.20.00	MFZ430
1230549	4256.20.00	GMF420K
1239659	4300.30.00	430GTZ
1250710	8916.40.00	KZIZ - 5
1272115	4300.30.00	430GTZ
1287597	4300.30.00	430GTZ
1303975	8916.40.00	KZIZ - 5
1329549	4303.20.00	MFZ430
1362752	8916.40.00	KZIZ - 5
1375593	3953.30.00	395WGTZ
1375597	3953.20.00	MF395
1393177	43100.20.00	MFZ430E
1393177R	43100.20.00	MFZ430E
1458592	43100.20.00	MFZ430E
1458592R	43100.20.00	MFZ430E
160795	3107.20.00	GF310K
161 852	4205.20.00	G420KR
161 854	3829.20.00	GF380KR
1625967	4200.90.02	
1625968	4300.50.03	
1625968	4300.90.03	
1625968R	4300.50.03	
1625971	4300.90.181	
1625971R	4300.90.181	
1628626	4300.50.03	
1628627	4300.90.181	
1628627R	4300.90.181	
165 495	4208.30.00	420GS
165 499	4209.30.00	420GS
166 5428	4371.20.00	MFZ430
1663216	43100.20.00	MFZ430E
1663218	4338.30.00	430WGTZ
1663220	43134.30.00	430WGTZ
1664346	8916.40.00	KZIZ - 5
1685711	43134.30.00	430WGTZ
1686642	8939.40.00	KZISZ - 5
1697725	8939.40.00	KZISZ - 5
1700508R	3953.20.00	MF395
1703740	3953.20.00	MF395
1703740R	3953.20.00	MF395
1705377	3953.30.00	395WGTZ
1706757R	4300.90.69	
1706758R	4300.90.189	
1714246R	4300.90.181	
1714249R	4300.90.188	
1714759R	4300.90.189	
1736890	3950.90.07	
1736890R	3950.90.07	
1746150	8939.40.00	KZISZ - 5
1780332	8916.40.00	KZIZ - 5
1789280R	4300.50.03	
1789281	4300.90.181	
1789281R	4300.90.181	
1789294R	4300.50.03	
1789295R	4300.50.03	
1810168	8916.40.00	KZIZ - 5
1814035	4300.90.72	
1814035R	4300.90.72	
1815768R	4300.50.03	
1815769R	4300.90.181	

Cross reference list

OEM reference	RUEN reference	Parameter
DAF >>		
1816434R	4300.90.188	
1816435R	4300.90.89	
1816436R	4300.90.69	
1818190R	3953.20.00	MF395
1820661R	4300.90.89	
1820662R	4300.90.97	
1822487	8939.40.00	KZISZ - 5
1829974R	8939.40.00	KZISZ - 5
1830316	8939.40.00	KZISZ - 5
1836353R	3950.90.08	
1843938R	3953.20.00	MF395
1846414	43134.30.00	430WGTZ
1846414R	43134.30.00	430WGTZ
1846416	4338.30.00	430WGTZ
1851348R	4300.50.03	
1851349R	4300.90.181	
1851350R	4300.90.72	
1851351R	4300.50.03	
1851352R	4300.90.188	
1858564	43104.20.00	MFZ430
1912687	8939.40.00	KZISZ - 5
1912689	8916.40.00	KZIZ - 5
1935390	4300.50.03	
1935391R	4300.90.181	
1935392R	4300.90.72	
1935393R	4300.50.03	
1935394R	4300.90.188	
19353963R	4300.50.03	
1935396R	4300.90.89	
1935397R	4300.90.69	
1935399R	4300.90.97	
1935399R	8939.40.00	KZISZ - 5
252 683	3564.30.00	350GSZ
259 814	3524.20.00	GF350KR
286 877	3573.20.00	MF350
331 815	3563.30.00	350GSZ
504039135	3953.20.00	MF395
616 542	3852.30.00	380GS
661 066	3885.30.00	380GSZ
666 432	4210.30.00	420/210GSZ
679 884	4268.20.00	GMF420K
740 784	4244.30.00	420/210GSZ
740 802	4255.30.00	420GS
ATRB563	3953.20.00	MF395
ATRC239	35173.20.00	MF350
ATRC342	35101.30.00	350WGTZ

DAF (TÜRKİYE)

0376491	3878.20.00	GMF380
0740784	4244.30.00	420/210GSZ
1329549	4303.20.00	MFZ430
1348144	3563.30.00	350GSZ
1362752	8916.40.00	KZIZ - 5
138933	4334.30.00	430GTZ
1395705	4256.30.00	420GS
500908	3524.20.00	GF350KR

DAVID BROWN

K89322	2517.30.00	250
--------	------------	-----

EICHER

175 522.M91	2802.20.00	G280
-------------	------------	------

OEM reference	RUEN reference	Parameter
3141 909.M1	3300.20.00	GFM330
707 465	2262.20.00	KS225
707 652	2518.20.00	G250
707 829	3131.20.00	G310
707 840	2262.20.00	KS225
708 772	2256.30.00	225Z

ENASA

773 008	4310.30.00	430WGVZ
---------	------------	---------

EOBUS

0.072.505.004	43100.20.00	MFZ430E
8.383.219.000	4253.20.00	GFX420KR
8.383.244.000	4253.20.00	GFX420KR

FENDT

F 015.100.100.230	2262.20.00	KS225
F 181.10.101.040	3130.20.00	G310K
F 181.100.100.060	3133.20.00	G310
X 805.230.103.010	2510.30.00	250Z

FIAT

4 456 2120 EB	2353.20.00	MFZ235
7 588 805	3903.40.00	KZIS-0
7 681 283	3903.40.00	KZIS-0

FORD

1475 197	2403.20.00	MF240
1518 419	2403.20.00	MF240
5 010 155	2150.90.10	
5 011 070	2150.90.10	
5 013 615	2150.90.10	
5 050 664	2150.90.10	
6055 852	2171.20.00	MF215K
6076 152	2172.30.00	215D
6107851	2171.20.00	MF215K
6107852	2171.20.00	MF215K
83BB 7563 CA	2171.20.00	MF215K
83BB 7563 DA	2171.20.00	MF215K
85BB 7563 AA	2171.20.00	MF215K

FORD (TÜRKİYE)

3C467550AA	3965.30.00	15.5" 395GTZ
3C467563CA	3962.20.00	15.5" MF 395
AM84DB7550CB	3258.30.00	325GSZ
AM90CT7550B1A	3574.30.00	14" 350GSZ
AM93CT7563AA	3574.20.00	14" MF 350

FORD NEW HOLLAND

4045 02 48	3520.20.00	GF350KR
4107 05	3107.20.00	GF310K

HYUNDAI

41200-8D000	43100.20.00	MFZ430E
-------------	-------------	---------

IKARUS

082.14.1045-005	4222.20.00	GF420KR
1299 393 670	8500.40.00	KZI - 4,5

IMR-BEOGRAD

707 644	2802.30.00	280BHZ
800 196	2802.20.00	G280
815 643	2802.20.00	G280

Cross reference list

OEM reference	RUEN reference	Parameter
IMT-BEOGRAD-MASSEY FERGUSON		
514 00 260	4201.20.00	G420KR
INDOS		
000 24 75	2803.20.00	G280
190 00J	2801.20.00	G280
203 10 33	2802.30.00	280BHZ
8751-52-01.30	2802.20.00	G280
IVECO		
0126 6638	3552.30.00	350
0190 3834	4300.90.06	
0190 3838	4300.90.06	
0190 3881	4299.20.00	GFX420K
0190 4749	2350.90.01	
0190 4755	3300.90.01	
0190 4779	4300.90.02	
0190 4780	4300.90.04	
0190 4788	4300.90.06	
0190 4794	2400.90.01	
0190 4797	2350.90.01	
0190 5703	4300.90.04	
0190 5717	4300.90.02	
0190 8504	3300.90.01	
0190 8520	2350.90.01	
0190 8522	2400.90.01	
0190 8534	4300.90.06	
0190 8537	3300.90.01	
0190 8552	2350.90.01	
0190 8555	2350.90.01	
0190 8559	3300.90.01	
01903832	3328.30.00	330WGSZ
01903841	2651.20.00	MF265
01903841	2655.30.00	265TB
01903890	3328.30.00	330WGSZ
01903907	2654.20.00	MF270
01903907	2656.30.00	270CTB
01903914	2650.90.01	
01904704	3328.30.00	330WGSZ
01904705	3328.30.00	330WGSZ
01904710	2654.20.00	MF270
01904710	2656.30.00	270CTB
01904718	2650.90.01	
01904760	2650.90.15	
01904771	3328.30.00	330WGSZ
01904772	3328.30.00	330WGSZ
01904785	4005.30.00	400GVZ
01904795	2650.90.01	
01904798	2650.90.15	
01908521	2650.90.01	
01908523	2650.90.15	
01908543	2800.90.31	
01908544	2650.90.15	
01908545	2654.20.00	MF270
01908545	2656.30.00	270CTB
01908553	2800.90.31	
01908574	2650.90.15	
0244 23 06	3899.30.00	380GSZ
0244 23 07	3899.30.00	380GSZ
0244 2557	3812.30.00	380GSZ
0244 3805	2819.30.00	280GSZ
0247 6483	4250.20.00	GFX420KR
0247 7328	3536.20.00	GF350K

OEM reference	RUEN reference	Parameter
0247 9048	8514.40.00	KZI - 4,5
0247 9856	2955.20.00	GF295
0445 9822	4277.20.00	GFX420KR
0460 7799	2514.30.00	250CBL
0469 2717	4277.20.00	GFX420KR
0472 4694	8512.40.00	KZI - 4,5
0475 7082	8510.40.00	KZI - 4,5
0476 6075	3816.30.00	380GSZ
0478 7649	3169.20.00	MF310
0478 7652	3169.20.00	MF310
0483 9133	3816.30.00	380GSZ
049 99 161	4265.30.00	420GSZ
0855 8284	2810.30.00	280CBL
0856 6183	2514.30.00	250CBL
0857 8611	2810.30.00	280CBL
0858 2397	2810.30.00	280CBL
0858 8630	2810.30.00	280CBL
08586808	2656.30.00	270CTB
08586809	2654.20.00	MF270
08587332	2656.30.00	270CTB
08597015	2656.30.00	270CTB
08598464	2656.30.00	270CTB
08598873	2858.30.00	280GTZ
127 2055	3801.20.00	G380KR
127 8622	3804.20.00	G380KR
1447 9854	2955.20.00	GF295
190.00-J	2801.20.00	G280
244 2308	3810.20.00	G380KR
244 2557	3812.30.00	380GSZ
244 2558	3812.30.00	380GSZ
244 2563	3810.20.00	G380KR
244 2596	3861.30.00	380W2GSZ
244 3712	3805.30.00	380WGSZ
244 3713	3805.30.00	380WGSZ
244 3714	3805.30.00	380WGSZ
244 3844	3861.30.00	380W2GSZ
2443797KZ	3512.30.00	350W2GSZ
247 5334	4236.30.00	420/210GSZ
247 6075	3502.30.00	350GSZ
247 6666	4247.30.00	420GSZ
247 7181	4236.30.00	420/210GSZ
247 7896A	4236.30.00	420/210GSZ
247 7898	3804.20.00	G380KR
247 7898	3805.30.00	380WGSZ
247 7930	3812.30.00	380GSZ
296 0741	3861.30.00	380W2GSZ
2991656	2650.90.15	
2992012	2650.90.15	
2992026	2800.90.31	
2992215	2800.90.31	
2992474	2350.90.01	
2992556	2650.90.15	
2992580	2800.90.31	
2992630	2800.90.31	
2992631	2650.90.15	
2994017	2350.90.01	
2994018	2650.90.15	
2994020	2800.90.31	
2994026	2650.90.15	
2994027	2800.90.31	
2994034	2650.90.15	
2994036	2800.90.31	
2994037	2650.90.15	
2994040	2650.90.01	

Cross reference list

OEM reference	RUEN reference	Parameter
IVECO >>		
2994069	2350.90.01	
2995559	2800.90.31	
2995704	2650.90.15	
2995705	2800.90.31	
2995706	2650.90.15	
2995724	2800.90.32	
2995776	2800.90.31	
2996089	2800.90.31	
2996321	2800.90.32	
2996525	3620.90.52	
4200 3033	3814.20.00	G380KR
4200 3325	3805.30.00	380WGSZ
4200 3473	8514.40.00	KZI - 4,5
4200 3474	8514.40.00	KZI - 4,5
4200 3736	3804.20.00	G380KR
4201 4240	4298.20.00	GF420
4201 4394	4237.20.00	GF420KR
4202 6780	4278.20.00	GFX420KR
4203 7237	3570.20.00	GMF350
4203 7967	3166.20.00	MF310
4206 1041	3581.20.00	GMF350KR
4206 1357	3585.30.00	350GSZ
4206 3184	8514.40.00	KZI - 4,5
42061411	3328.30.00	330WGSZ
4210 0567KZ	4268.30.00	420GSZ
4210 2097	4301.20.00	MFZ430
4210 2099	4301.20.00	MFZ430
4210 2148	3140.30.00	310W2GSZ
4210 2161	3805.30.00	380WGSZ
4210 2170	4247.30.00	420GSZ
4210 3036	4300.90.04	
42102151	3328.30.00	330WGSZ
42102151/U-E	3328.30.00	330WGSZ
42102151/V-E	3328.30.00	330WGSZ
42102151/V-S	3328.30.00	330WGSZ
42102156	3512.30.00	350W2GSZ
42102168	4005.30.00	400GVZ
42102970	4006.30.00	400GVZ
42103321	4005.30.00	400GVZ
42104649	4006.30.00	400GVZ
42104709	3328.30.00	330WGSZ
42104991	4005.30.00	400GVZ
42112970	4006.30.00	400GVZ
42159115	2820.20.00	MF280
445 9152	4226.20.00	GF420KR
445 9836	2832.30.00	280GTZ
445 9883	2820.20.00	MF280
460 5181	5800.40.00	KZA - 2
469 9160	4236.20.00	GF420KR
472 4654	8512.40.00	KZI - 4,5
4739151	4265.30.00	420GSZ
500055597	3620.90.51	
500055599	3620.90.50	
500059758	3620.90.52	
500059774	4300.90.94	
500059776	4390.30.00	430WGTZ
500059778	4300.90.110	
500059780	4300.90.94	
500059786	4300.90.179	
500059788	4300.90.109	
5003 92642	4300.90.02	
5003 92643	4300.90.02	

OEM reference	RUEN reference	Parameter
500335096	4300.90.177	
500335105	4300.90.04	
500371281	4300.90.04	
504004160	4300.90.04	
504029031	43460.30.00	430WGTZ
504039135	7451.40.00	KZIS-4
504059764	2350.90.01	
504061486	2350.90.01	
504080319	2350.90.01	
504122591	2800.90.31	
504148901	4300.90.94	
504148902	4300.90.94	
504148904	4300.90.178	
504148905	4300.90.110	
504148906	4300.90.110	
504149340	4339.30.00	430WGTZ
504149351	4390.30.00	430WGTZ
504149354	4390.30.00	430WGTZ
504213753	8514.40.00	KZI - 4,5
504221984	4300.90.94	
504221985	4300.90.178	
504225011	4300.90.110	
504225016	4390.30.00	430WGTZ
504225031	4300.90.94	
504225038	4300.90.94	
504225051	4300.90.110	
504229179	8514.40.00	KZI - 4,5
504229188	8514.40.00	KZI - 4,5
504237890	4300.90.68	
504237892	4300.90.109	
504256059	4390.30.00	430WGTZ
504264336	4300.90.94	
504264337	4300.90.109	
504285997	4300.90.68	
504285998	4300.90.179	
504286000	4300.90.109	
51.07-52-01.04	2518.20.00	G250
5107-52-01-03	2518.30.00	250GSZ
5801555056	3620.90.51	
5801558431	4339.30.00	430WGTZ
58017 29653	3620.90.50	
5801712140	4390.30.00	430WGTZ
70704 0185	2514.20.00	H250K
7704 0185	2514.30.00	250CBL
7709 7510	2810.30.00	280CBL
8602 1252	3162.20.00	MF310
8602 1253	3162.20.00	MF310
8751-52-11.01	3540.20.00	LA350
8751-52-11.03	3522.30.00	350GSZ
8751-52-11.35	3522.30.00	350GSZ
8751-52-12.20	3131.20.00	G310
9380 1198	2402.30.00	240PSD
93801297	2651.20.00	MF265
93801299	2655.30.00	265TB
93808507	2655.30.00	265TB
93808508	2651.20.00	MF265
93808930	2651.20.00	MF265
93809013	2651.20.00	MF265
93811556	2655.30.00	265TB
93812451	2658.20.00	MFZ265
93812507	2678.30.00	265VTP
93812508	2658.20.00	MFZ265
9840 0708	3179.20.00	MFZ310
9840 0713	3179.20.00	MFZ310

Cross reference list

OEM reference	RUEN reference	Parameter
IVECO >>		
9840 0725	3312.20.00	MFZ330
9840 0726	3312.20.00	MFZ330
98401893	2858.30.00	280GTZ
98419240	2858.30.00	280GTZ
98436159	4006.30.00	400GVZ
98448583	2678.30.00	265VTP
98471641	2650.90.15	
98471692	2678.30.00	265VTP
98481323	2858.30.00	280GTZ
98481325	2858.30.00	280GTZ
98481328	2858.30.00	280GTZ
98490360	2858.30.00	280GTZ
98495997	4005.30.00	400GVZ
98495998	4006.30.00	400GVZ
98496859	2858.30.00	280GTZ
98499254	4006.30.00	400GVZ
99430262	4005.30.00	400GVZ
99430263	4006.30.00	400GVZ
99473296	2658.20.00	MFZ265

IVECO-FIAT (TÜRKİYE)		
019038887	4268.30.00	420GSZ
01904730	4327.30.00	430GTZ
01904751	4301.20.00	MFZ430
01904785	8919.40.00	KZISZ - 5
01908524	4326.30.00	430WGTZ

JOHN DEERE		
AZ 35261	3160.20.00	MF310
AZ 36712	3300.20.00	GFM330

KAELBLE		
59 286	3552.30.00	350

KLOCKNER-HUMBOLDT-DEUTZ (KOLN)		
0127 8622	3804.20.00	G380KR
1-1116-300-570.10	2802.20.00	G280

LIAZ		
4421-7050-570.9	3860.20.00	GM380K

LIEBHERR		
5031-18808	4386.20.00	MFZ430

MAGIRUS-DEUTZ		
01260500	3505.20.00	G350KR
01260638	3505.20.00	G350KR
01261333	3804.20.00	G380KR
01262431	3804.20.00	G380KR
01266503	3505.20.00	G350KR
01266566	3804.20.00	G380KR
0127 2047 /U-E	3505.20.00	G350KR
01271852	3807.20.00	G380KR
01271976	3807.20.00	G380KR
01272035	3505.20.00	G350KR
01272040	3505.20.00	G350KR
01272042	3505.20.00	G350KR
01272047	3505.20.00	G350KR
01272048	3505.20.00	G350KR
01278622	3804.20.00	G380KR
01903816	3895.20.00	G380KR

OEM reference	RUEN reference	Parameter
01903848	3505.20.00	G350KR
01903849	3505.20.00	G350KR
01903850	3505.20.00	G350KR
01903873	3804.20.00	G380KR
01903874	3804.20.00	G380KR
01903875	3804.20.00	G380KR
01903876	3804.20.00	G380KR
01903877	3804.20.00	G380KR
01903878	3804.20.00	G380KR
01903879	4298.20.00	GF420
01903890	3300.20.00	GFM330
01903890	3328.30.00	330WGSZ
01903925	3895.20.00	G380KR
01903946	3804.20.00	G380KR
01903948	3505.20.00	G350KR
01903950	3804.20.00	G380KR
01903950	3805.30.00	380WGSZ
01903952	3804.20.00	G380KR
01903952	3805.30.00	380WGSZ
01903955	3505.20.00	G350KR
01903956	3804.20.00	G380KR
01903957	4298.20.00	GF420
01904705	3300.20.00	GFM330
01904705	3328.30.00	330WGSZ
01904713	3804.20.00	G380KR
01904715	3804.20.00	G380KR
01904716	3804.20.00	G380KR
01904772	3300.20.00	GFM330
01904772	3328.30.00	330WGSZ
01904791	4298.20.00	GF420
02442309	3807.20.00	G380KR
02443712	3805.30.00	380WGSZ
02475546	6905.40.00	KZIS - 3
02475547	6905.40.00	KZIS - 3
02477898	3804.20.00	G380KR
02565803	6905.40.00	KZIS - 3
04626605	3804.20.00	G380KR
04695659	3804.20.00	G380KR
04695660	3804.20.00	G380KR
04733573	4298.20.00	GF420
42003033	3804.20.00	G380KR
42003325	3805.30.00	380WGSZ
42003396	6905.40.00	KZIS - 3
42003397	6905.40.00	KZIS - 3
42003734	3807.20.00	G380KR
42003736	3804.20.00	G380KR
42003737	3804.20.00	G380KR
42003852	4298.20.00	GF420
42016352	3300.20.00	GFM330
42026352	3300.20.00	GFM330
42026354	3300.20.00	GFM330
42026354/KZ	3300.20.00	GFM330
42061921	6905.40.00	KZIS - 3
42066352	3300.20.00	GFM330
42102161	3805.30.00	380WGSZ
42532403	4298.20.00	GF420
61146805	3505.20.00	G350KR
61146808	3804.20.00	G380KR
61751945	3804.20.00	G380KR
8739-47-13.10	3505.20.00	G350KR
8739-47-21.10	3804.20.00	G380KR
8751-52-51.36	3505.20.00	G350KR
8751-52-51.64	3505.20.00	G350KR
8751-52-51.65	3505.20.00	G350KR

Cross reference list

OEM reference	RUEN reference	Parameter
MAGIRUS-DEUTZ >>		
8751-52-51.92	3804.20.00	G380KR
MAN		
30.30305.0048	4225.20.00	GF420KR
32.30305.0027	4387.20.00	MFZ430
36.30550.0001	8919.40.00	KZISZ - 5
81.30000.6532	3950.90.02	
81.30000.6577	4300.90.101	
81.30000.6587	4301.20.00	MFZ430
81.30000.6587	4356.30.00	430WGTZ
81.30000.6587	8916.40.00	KZIZ - 5
81.30000.6593	4300.90.101	
81.30000.6600	4301.20.00	MFZ430
81.30000.6600	4356.30.00	430WGTZ
81.30000.6600	8916.40.00	KZIZ - 5
81.30000.6601	4301.20.00	MFZ430
81.30000.6602	4301.20.00	MFZ430
81.30000.6602	43460.30.00	430WGTZ
81.30000.6621	4300.90.101	
81.30000.6634	4300.90.101	
81.30005.9006	3950.90.02	
81.30005.9013	4300.90.05	
81.30005.9013	4300.90.051	
81.30005.9020	4300.90.051	
81.30005.9021	4300.90.05	
81.30005.9021	4300.90.051	
81.30005.9026	4300.90.101	
81.30005.9027	4300.90.101	
81.30005.9029	4300.90.051	
81.30005.9039	3620.90.19	
81.30301.0001	3610.30.00	362GTZ
81.30301.0008	2827.30.00	280Z
81.30301.0074	3155.30.00	310Z
81.30301.0098	3514.30.00	350WGSZ
81.30301.0106	4283.30.00	420WGSZ
81.30301.0112	4250.30.00	420WGSZ
81.30301.0116	4249.30.00	420W2GSZ
81.30301.0128	3510.30.00	350W2GSZ
81.30301.0148	4250.30.00	420WGSZ
81.30301.0150	3871.30.00	380/70GSZ
81.30301.0151	3870.30.00	380/210GSZ
81.30301.0183	3894.30.00	380GSZ
81.30301.0206	4287.30.00	420GVZ
81.30301.0228	3806.30.00	380W2GSZ
81.30301.0228	3857.30.00	380W2GSZ
81.30301.0250	4281.30.00	420WGVZ
81.30301.0279	3587.30.00	350GSZ
81.30301.0284	38115.30.00	380GSZ
81.30301.0293	3510.30.00	350W2GSZ
81.30301.0299	4010.30.00	400WGVZ
81.30301.0300	4011.30.00	400GVZ
81.30301.0342	4249.30.00	420W2GSZ
81.30301.0350	3309.30.00	330GSZ
81.30301.0364	4009.30.00	400WGVZ
81.30301.0375	3596.30.00	350WGSZ
81.30301.0378	3951.30.00	395WGTZ
81.30301.0380	3309.30.00	330GSZ
81.30301.0393	3610.30.00	362GTZ
81.30301.0395	3610.30.00	362GTZ
81.30301.0416	4386.30.00	430WGTZ
81.30301.0438	4356.30.00	430WGTZ
81.30301.0440	43460.30.00	430WGTZ

OEM reference	RUEN reference	Parameter
81.30301.0448	4386.30.00	430WGTZ
81.30301.0449	3607.30.00	362WGTZ
81.30301.0456	4356.30.00	430WGTZ
81.30301.0457	4356.30.00	430WGTZ
81.30301.0470	3607.30.00	362WGTZ
81.30301.0475	3610.30.00	362GTZ
81.30301.0478	4386.30.00	430WGTZ
81.30301.0490	3607.30.00	362WGTZ
81.30301.0491	3607.30.00	362WGTZ
81.30301.0492	3607.30.00	362WGTZ
81.30301.0497	4356.30.00	430WGTZ
81.30301.0498	4356.30.00	430WGTZ
81.30301.0500	43460.30.00	430WGTZ
81.30301.0509	43460.30.00	430WGTZ
81.30301.0520	3607.30.00	362WGTZ
81.30301.0522	4386.30.00	430WGTZ
81.30301.0524	3951.30.00	395WGTZ
81.30301.0526	4386.30.00	430WGTZ
81.30301.0529	3607.30.00	362WGTZ
81.30301.0538	4386.30.00	430WGTZ
81.30301.0556	3607.30.00	362WGTZ
81.30301.0557	3951.30.00	395WGTZ
81.30301.0558	3951.30.00	395WGTZ
81.30301.0578	43461.30.00	430WGTZ
81.30301.0580	3957.30.00	395WGTZ
81.30301.0582	43460.30.00	430WGTZ
81.30301.0583	43460.30.00	430WGTZ
81.30301.0588	43461.30.00	430WGTZ
81.30301.0601	3951.30.00	395WGTZ
81.30301.0622	43461.30.00	430WGTZ
81.30301.0625	43460.30.00	430WGTZ
81.30301.0627	43461.30.00	430WGTZ
81.30301.0628	43461.30.00	430WGTZ
81.30301.0669	43461.30.00	430WGTZ
81.30301.6005	3588.30.00	350GSZ
81.30301.6099	43461.30.00	430WGTZ
81.30301.9110	4248.30.00	420W2GSZ
81.30301.9378	3951.30.00	395WGTZ
81.30301.9393	3610.30.00	362GTZ
81.30301.9438	4356.30.00	430WGTZ
81.30301.9457	4356.30.00	430WGTZ
81.30301.9473	4386.30.00	430WGTZ
81.30301.9492	3607.30.00	362WGTZ
81.30301.9557	3951.30.00	395WGTZ
81.30301.9575	4386.30.00	430WGTZ
81.30301.9627	43461.30.00	430WGTZ
81.30301.9669	43461.30.00	430WGTZ
81.30305.0184	3312.20.00	MFZ330
81.30305.0006	3131.20.00	G310
81.30305.0046	3835.20.00	GF380
81.30305.0078	4224.20.00	GF420KR
81.30305.0079	3835.20.00	GF380
81.30305.0099	2835.20.00	MFZ280
81.30305.0111	4235.20.00	GF420KR
81.30305.0112	3168.20.00	MF310
81.30305.0113	4244.20.00	GFX420KR
81.30305.0113	4253.20.00	GFX420KR
81.30305.0117	4253.20.00	GFX420KR
81.30305.0120	3877.20.00	GMF380
81.30305.0124	4244.20.00	GFX420KR
81.30305.0138	4301.20.00	MFZ430
81.30305.0139	4301.20.00	MFZ430
81.30305.0158	4301.20.00	MFZ430
81.30305.0162	3573.20.00	MF350

Cross reference list

OEM reference	RUEN reference	Parameter
MAN >>		
81.30305.0164	3856.10.00	GF2/380
81.30305.0165	4301.20.00	MFZ430
81.30305.0166	4300.20.00	MFZ430
81.30305.0179	4301.20.00	MFZ430
81.30305.0182	4301.20.00	MFZ430
81.30305.0184	3313.20.00	MFZ330
81.30305.0191	4301.20.00	MFZ430
81.30305.0193	4301.20.00	MFZ430
81.30305.0194	4301.20.00	MFZ430
81.30305.0201	3610.20.00	MFZ362
81.30305.0217	43100.20.00	MFZ430E
81.30305.0229	4386.20.00	MFZ430
81.30305.0232	3601.20.00	MF362
81.30305.0233	3956.20.00	MFZ395
81.30305.0236	3972.20.00	MF395
81.30305.0237	43100.20.00	MFZ430E
81.30305.0239	4386.20.00	MFZ430
81.30305.0249	3855.30.00	380GS
81.30305.6007	2802.20.00	G280
81.30305.6020	4205.20.00	G420KR
81.30305.6024	4222.20.00	GF420KR
81.30305.6028	4224.20.00	GF420KR
81.30305.6053	3856.10.00	GF2/380
81.30305.9104	3180.20.00	GMFZ310KR
81.30305.9113	4253.20.00	GFX420KR
81.30305.9191	4301.20.00	MFZ430
81.30305.9193	4301.20.00	MFZ430
81.30305.9194	4301.20.00	MFZ430
81.30305.9201	3610.20.00	MFZ362
81.30305.9219	4386.20.00	MFZ430
81.30305.9229	4386.20.00	MFZ430
81.30305.9232	3601.20.00	MF362
81.30305.9233	3956.20.00	MFZ395
81.30305.9236	3972.20.00	MF395
81.30401.7009	3520.20.00	GF350KR
81.30550.0041	8505.40.00	KZI - 4,5
81.30550.0050	8505.40.00	KZI - 4,5
81.30550.0074	8633.47.00	HHISZ-3
81.30550.0079	8633.47.00	HHISZ-3
81.30550.0082	8535.40.00	KZIZ - 4,5
81.30550.0096	8919.40.00	KZISZ - 5
81.30550.0101	8919.40.00	KZISZ - 5
81.30550.0102	8919.40.00	KZISZ - 5
81.30550.0103	8916.40.00	KZIZ - 5
81.30550.0109	8916.40.00	KZIZ - 5
81.30550.0110	8916.40.00	KZIZ - 5
81.30550.0114	8919.40.00	KZISZ - 5
81.30550.0115	8632.47.00	Fill Medium: Minerz
81.30550.0116	8916.40.00	KZIZ - 5
81.30550.0118	8936.40.00	KZISZ - 5
81.30550.0118	8939.40.00	KZISZ - 5
81.30550.0249	8936.40.00	KZISZ - 5
81.30550.0249	8939.40.00	KZISZ - 5
81.30550.0250	8632.47.00	Fill Medium: Minerz
81.30550.0251	8936.40.00	KZISZ - 5
81.30550.0251	8939.40.00	KZISZ - 5
81.30550.0255	8936.40.00	KZISZ - 5
81.30550.0255	8939.40.00	KZISZ - 5
81.30550.0264	8936.40.00	KZISZ - 5
81.30550.0264	8939.40.00	KZISZ - 5
81.30550.0270	8936.40.00	KZISZ - 5
81.30550.0270	8939.40.00	KZISZ - 5

OEM reference	RUEN reference	Parameter
81.30716.6105	8632.47.00	Fill Medium: Minerz
81.32412.0006	8936.40.00	KZISZ - 5
81.32412.0006	8939.40.00	KZISZ - 5
81.99164.1328	3896.30.00	380WGSZ
8130301.0249	4250.30.00	420WGSZ
8130305.0166	4300.20.00	MFZ430
82.30005.9004	4300.90.101	
82.30301.0045	4387.30.00	430WGTZ
82.30305.0027	4387.20.00	MFZ430
88.30301.0009	3530.30.00	350GSZ
88.30304.0003	3804.20.00	G380KR
88.30305.0002	3807.20.00	G380KR
88.30305.0003	3804.20.00	G380KR
88.30305.9003	3804.20.00	G380KR
90.44562.01	3804.20.00	G380KR
90.90445.6201	3804.20.00	G380KR
VA.30000.9434	4300.90.051	
VA.30000.9876	4300.90.101	

MAN (TÜRKİYE)

81.30301.0139	4036.30.00	400 WGTZ
81.30301.0228	38106.30.00	380WGTZ
81.30301.0247	3597.30.00	350 WGTZ
81.30301.0250	4281.30.00	420WGVZ
81.30301.0300	4026.30.00	400GTZ
81.30301.0378	3951.30.00	395WGTZ
81.30301.0393	3610.30.00	362GTZ
81.30301.0492	3607.30.00	362WGTZ
81.30301.0505	4306.30.00	430WGTZ
81.30305.0124	4244.20.00	GFX420KR
81.30305.0193	4301.20.00	MFZ430
81.30305.0198	3956.20.00	MFZ395
81.30305.0200	4028.10.00	MFZ2/400X
81.30305.0201	3610.20.00	MFZ362
81.30305.0220	4319.20.00	MFZ430
81.30305.0252	3601.20.00	MF362
81.30401.7013	3505.20.00	G350KR
81.30550.0104	8919.40.00	KZISZ - 5
81.30550.0109	8916.40.00	KZIZ - 5

MANITOU

33472	2517.20.00	G250K
90395	2802.20.00	G280

MASSEY FERGUSON

1603 572 M1	2260.20.00	KS225
417 404 M1	2256.30.00	225Z
945 522 M91	2802.20.00	G280
975 522 M91	2802.20.00	G280

MERCEDES (TÜRKİYE)

000 250 63 03	2528.30.00	250BHZX
001 250 00 04	3522.20.00	GF350KR
001 250 75 04	2507.20.00	HBX250
001 250 97 03	3519.30.00	350GSZ
002 250 41 15	8918.40.00	KZISZ - 5
002 250 96 04	3101.20.00	GFX310
003 250 22 04	3822.20.00	GF380KR
003 250 28 04	3821.20.00	GF380KR
003 250 48 04	3565.20.00	GMF350
003 250 61 04	4244.20.00	GFX420KR
003 250 70 04	4235.20.00	GF420KR
003 250 99 04	3305.20.00	GMF330
004 250 24 04	3580.20.00	GMF350

Cross reference list

OEM reference	RUEN reference	Parameter
MERCEDES (TÜRKİYE) >>		
004 250 89 04	4300.20.00	MFZ430
005 250 66 04	4329.60.00	MFZ430
005 250 84 04	4304.20.00	MFZ430
005 250 88 04	4010.10.00	MFZ2/400X
006 250 82 03	3325.30.00	330WGSZ
007 250 15 04	3951.20.00	MF395
007 250 51 04	4025.10.00	MFZ2/400X
007 250 74 03	3599.30.00	350 GTZ
008 250 08 03	3597.30.00	350 WGTZ
008 250 74 03	4212.30.00	420/210GSZ
010 250 89 03	4021.30.00	400GVZ
010 250 92 03	4020.30.00	400GVZ
011 250 02 03	38107.30.00	380 GTZ
011 250 02 03	4232.30.00	420GSZ
017 250 47 03	4306.30.00	430WGTZ
018 250 99 03	4306.30.00	430WGTZ
019 250 61 03	4025.30.00	400WGTZ
019 250 64 04	3606.20.00	MF362
019 250 91 03	3626.30.00	362 WGTZ
019 250 97 03	3961.30.00	395GTZ
020 250 15 03	4318.30.00	430WGTZ
020 250 93 03	4026.30.00	400GTZ
022 250 48 01	4000.90.04	
022 250 57 01	4300.90.15	

MERCEDES-BENZ		
000 250 32 03	3522.30.00	350GSZ
000 250 38 15	8509.40.00	KZI - 4,5
000 250 40 15	6908.40.00	KZ - 3
000 250 41 04	3807.20.00	G380KR
000 250 42 15	6901.40.00	KZI - 3
000 250 46 15	6901.40.00	KZI - 3
000 250 63 04	2953.20.00	GF295
000 250 70 15	8529.40.00	KZI - 4,5
000 250 73 15	8513.40.00	KZI - 4,5
000 250 74 15	8500.40.00	KZI - 4,5
000 250 75 15	8520.40.00	KZI - 4,5
000 250 76 15	8511.40.00	KZI - 4,5
000 250 77 15	8500.40.00	KZI - 4,5
000 250 78 15	6907.40.00	KZI - 3
000 250 81 04	2530.20.00	G250
000 250 82 03	2954.30.00	295BHZ
000 250 87 04	2812.20.00	HVB280
000 250 92 15	9302.40.00	KZI-6
000 250 99 04	2507.20.00	HBX250
000 254 03 20	8603.47.00	HHIS-3
000 254 04 20	8603.47.00	HHIS-3
000 254 30 20	8603.47.00	HHIS-3
001 250 01 04	3521.20.00	GF350KR
001 250 03 04	3120.20.00	GFX310
001 250 16 04	3522.20.00	GF350KR
001 250 38 03	2954.30.00	295BHZ
001 250 55 03	3822.30.00	380GSZ
001 250 67 03	3822.30.00	380GSZ
001 250 69 03	2538.30.00	250TPZ
001 250 74 04	3522.20.00	GF350KR
001 250 75 04	2507.20.00	HBX250
001 250 79 15	8905.40.00	KZIZ - 5
001 250 85 04	4235.20.00	GF420KR
001 250 87 04	2530.20.00	G250
001 250 90 04	3122.20.00	GFX310
001 250 97 01	4300.90.15	

OEM reference	RUEN reference	Parameter
002 250 19 15	8603.47.00	HHIS-3
002 250 21 15	8603.47.00	HHIS-3
002 250 22 15	8603.47.00	HHIS-3
002 250 24 15	8653.47.00	HHIS-3
002 250 25 15	8653.47.00	HHIS-3
002 250 27 15	8603.47.00	HHIS-3
002 250 28 15	8653.47.00	HHIS-3
002 250 29 15	8603.47.00	HHIS-3
002 250 30 15	8653.47.00	HHIS-3
002 250 31 04	3821.20.00	GF380KR
002 250 31 15	6908.40.00	KZ - 3
002 250 31 15	8603.47.00	HHIS-3
002 250 33 03	4231.30.00	420GSZ
002 250 35 03	2528.30.00	250BHZX
002 250 38 04	4235.20.00	GF420KR
002 250 43 03	2538.30.00	250TPZ
002 250 51 15	8603.47.00	HHIS-3
002 250 52 15	8653.47.00	HHIS-3
002 250 55 15	8601.47.00	
002 250 58 15	8602.47.00	
002 250 60 15	8604.47.00	
002 250 61 04	3101.20.00	GFX310
002 250 62 15	8653.47.00	HHIS-3
002 250 65 15	8540.40.00	KZIS-4
002 250 66 15	8603.47.00	HHIS-3
002 250 72 15	8653.47.00	HHIS-3
002 250 73 04	2283.20.00	M228KR
002 250 73 15	8601.47.00	
002 250 74 03	2528.30.00	250BHZX
002 250 74 15	8602.47.00	
002 250 75 04	3580.20.00	GMF350
002 250 75 15	8604.47.00	
002 250 76 15	8653.47.00	HHIS-3
002 250 84 04	2845.20.00	HVB280
002 250 87 04	3300.20.00	GFM330
002 250 93 03	3892.30.00	380GSZ
002 250 94 04	3120.20.00	GFX310
002 250 96 04	3101.20.00	GFX310
002 250 97 03	3821.30.00	380GSZ
002 250 97 04	3119.20.00	GFX310
003 250 91 04	2282.20.00	M228KR
003 250 00 04	4235.20.00	GF420KR
003 250 10 04	2507.20.00	HBX250
003 250 11 04	2812.20.00	HVB280
003 250 12 04	2845.20.00	HVB280
003 250 14 04	3807.20.00	G380KR
003 250 16 04	3522.20.00	GF350KR
003 250 22 04	3822.20.00	GF380KR
003 250 24 04	3827.20.00	GF380KR
003 250 25 04	3821.20.00	GF380KR
003 250 33 03	2954.30.00	295BHZ
003 250 33 04	4234.20.00	GF420KR
003 250 34 04	3521.20.00	GF350KR
003 250 37 04	2283.20.00	M228KR
003 250 37 15	8947.40.00	KZISZ-5
003 250 39 03	2538.30.00	250TPZ
003 250 42 03	3117.30.00	310GSZ
003 250 44 04	2173.20.00	M215
003 250 47 04	2400.20.00	MF240
003 250 48 04	3563.20.00	GMF350
003 250 59 04	3300.20.00	GFM330
003 250 61 04	4253.20.00	GFX420KR
003 250 62 03	3522.30.00	350GSZ
003 250 70 04	4235.20.00	GF420KR

Cross reference list

OEM reference	RUEN reference	Parameter
MERCEDES-BENZ >>		
003 250 71 04	3831.20.00	GF380KR
003 250 75 15	8947.40.00	KZISZ-5
003 250 79 03	4234.30.00	420/210GSZ
003 250 79 03	4257.30.00	420GSZ
003 250 83 04	3857.20.00	G380KR
003 250 84 03	3300.30.00	330GSZ
003 250 84 04	3565.20.00	GMF350
003 250 86 03	3124.30.00	310GSBL
003 250 86 04	4253.20.00	GFX420KR
003 250 90 04	4253.20.00	GFX420KR
003 250 93 04	2837.20.00	MFZ280
003 250 94 04	3176.20.00	MFZ310
003 250 96 04	2823.20.00	MF280
003 250 98 04	3164.20.00	MF310
003 250 99 04	3305.20.00	GMF330
004 250 00 04	4296.20.00	GF420
004 250 17 03	2281.30.00	228PSD
004 250 23 03	2805.30.00	280BHZ
004 250 24 04	3580.20.00	GMF350
004 250 35 04	3887.10.00	GF2/380
004 250 47 03	2805.30.00	280BHZ
004 250 51 04	3176.20.00	MFZ310
004 250 54 04	3882.20.00	GF2/380
004 250 55 04KZ	3882.10.00	GF2/380
004 250 71 04	3857.10.00	GF2/380
004 250 88 04	4305.20.00	MFZ430
004 250 90 03	3519.30.00	350GSZ
004 250 96 03	3892.30.00	380GSZ
004 250 98 04	3882.10.00	GF2/380
005 250 10 03	2281.30.00	228PSD
005 250 11 04	3882.20.00	GF2/380
005 250 20 03	2400.30.00	240PSD
005 250 40 03	3583.30.00	350GSZ
005 250 64 04	4329.60.00	MFZ430
005 250 66 04	4329.60.00	MFZ430
005 250 70 03	2538.30.00	250TPZ
005 250 83 04	4305.20.00	MFZ430
005 250 84 04	4304.20.00	MFZ430
005 250 89 03	2538.30.00	250TPZ
005 250 95 03	2822.30.00	280GTZ
005 259 49 03	3899.30.00	380GSZ
006 250 46 03	3897.30.00	380GSZ
006 250 47 04	4025.10.00	MFZ2/400X
006 250 48 04	4025.10.00	MFZ2/400X
006 250 49 04	4025.10.00	MFZ2/400X
006 250 76 03	4298.30.00	420GSZ
006 250 78 03	3117.30.00	310GSZ
006 250 82 03	3325.30.00	330WGSZ
006 250 86 04	4025.10.00	MFZ2/400X
006 250 87 03	4272.30.00	420WGSZ
006 250 87 04	4025.10.00	MFZ2/400X
006 250 88 04	4025.10.00	MFZ2/400X
006 250 95 03	3891.30.00	380GS
007 250 03 03	3889.30.00	380GSZ
007 250 09 03	3897.30.00	380GSZ
007 250 10 03	3897.30.00	380GSZ
007 250 12 03	4297.30.00	420GSZ
007 250 23 04	3952.20.00	MF395
007 250 24 04	3952.20.00	MF395
007 250 28 04	4025.10.00	MFZ2/400X
007 250 29 04	4025.10.00	MFZ2/400X
007 250 30 04	4025.10.00	MFZ2/400X

OEM reference	RUEN reference	Parameter
007 250 32 04	4025.10.00	MFZ2/400X
007 250 33 04	4025.10.00	MFZ2/400X
007 250 34 04	4025.10.00	MFZ2/400X
007 250 38 03	3822.30.00	380GSZ
007 250 40 04	43100.20.00	MFZ430E
007 250 43 03	4258.30.00	420GSZ
007 250 44 04	4025.10.00	MFZ2/400X
007 250 47 04	4025.10.00	MFZ2/400X
007 250 50 03	3882.30.00	380GSZ
007 250 50 04	43100.20.00	MFZ430E
007 250 51 04	4025.10.00	MFZ2/400X
007 250 55 03	3888.30.00	380WGSZ
007 250 57 04	4340.60.00	MFZ430
007 250 61 04	4329.60.00	MFZ430
007 250 62 04	43100.20.00	MFZ430E
007 250 69 03	4290.30.00	420GSZ
007 250 74 03	3583.30.00	350GSZ
007 250 80 04	4340.60.00	MFZ430
007 250 82 04	4025.10.00	MFZ2/400X
007 250 85 03	2306.30.00	228GSB
007 250 86 03	2306.30.00	228GSB
007 250 95 04	43100.20.00	MFZ430E
007 250 99 03	3136.30.00	310WGSZ
008 250 06 03	3325.30.00	330WGSZ
008 250 08 03	3517.30.00	350WGSZ
008 250 10 04	4025.10.00	MFZ2/400X
008 250 13 04	4022.10.00	MFZ2/400X
008 250 16 03	3855.30.00	380GS
008 250 19 04	4025.10.00	MFZ2/400X
008 250 24 04	4329.60.00	MFZ430
008 250 25 04	4340.60.00	MFZ430
008 250 30 04	4329.60.00	MFZ430
008 250 32 04	4340.60.00	MFZ430
008 250 35 04	4025.10.00	MFZ2/400X
008 250 36 04	4025.10.00	MFZ2/400X
008 250 38 04	4022.10.00	MFZ2/400X
008 250 39 04	4022.10.00	MFZ2/400X
008 250 42 04	4025.10.00	MFZ2/400X
008 250 46 03	3575.30.00	350WGSZ
008 250 72 03	3126.30.00	310GSBL
008 250 92 04	4021.10.00	MFZ2/400X
008 250 93 04	4021.10.00	MFZ2/400X
009 250 01 03	3854.30.00	380GVZ
009 250 02 03	3854.30.00	380GVZ
009 250 05 04	4022.10.00	MFZ2/400X
009 250 08 04	4329.60.00	MFZ430
009 250 09 04	4340.60.00	MFZ430
009 250 10 04	4349.60.00	MFZ430
009 250 12 04	4022.10.00	MFZ2/400X
009 250 13 03	3124.30.00	310GSBL
009 250 13 03 KZ	3126.30.00	310GSBL
009 250 14 04	4025.10.00	MFZ2/400X
009 250 15 04	4025.10.00	MFZ2/400X
009 250 21 03	4305.30.00	430W2GTZ
009 250 23 04	4025.10.00	MFZ2/400X
009 250 25 04	4025.10.00	MFZ2/400X
009 250 26 03	2307.30.00	228CB
009 250 27 03	2307.30.00	228CB
009 250 30 03	2307.30.00	228CB
009 250 56 03	3117.30.00	310GSZ
009 250 57 03	3310.30.00	330GSZ
009 250 58 03	2538.30.00	250TPZ
009 250 59 03	2538.30.00	250TPZ
009 250 83 04	4329.60.00	MFZ430

Cross reference list

OEM reference	RUEN reference	Parameter
MERCEDES-BENZ >>		
009 250 85 04	4022.10.00	MFZ2/400X
010 250 07 04	4329.60.00	MFZ430
010 250 09 04	4349.60.00	MFZ430
010 250 10 04	4329.60.00	MFZ430
010 250 11 04	4340.60.00	MFZ430
010 250 13 03	4289.30.00	420GSZ
010 250 13 04	4022.10.00	MFZ2/400X
010 250 15 04	4025.10.00	MFZ2/400X
010 250 17 04	4025.10.00	MFZ2/400X
010 250 26 03	2281.30.00	228PSD
010 250 65 03	3854.30.00	380GVZ
010 250 66 03	3854.30.00	380GVZ
010 250 67 03	3854.30.00	380GVZ
010 250 77 03	3855.30.00	380GS
010 250 80 03	3854.30.00	380GVZ
011 250 65 03	3854.30.00	380GVZ
011 250 66 03	3854.30.00	380GVZ
011 250 67 03	3854.30.00	380GVZ
012 250 26 03	4272.30.00	420WGSZ
013 250 21 03	4305.30.00	430W2GTZ
013 250 57 03	3583.30.00	350GSZ
015 250 19 03	2548.30.00	250CD
015 250 46 03	3961.30.00	395GTZ
015 250 63 03	3961.30.00	395GTZ
015 250 68 03	3854.30.00	380GVZ
016 250 81 03	3960.30.00	395GTZ
016 250 82 03	3960.30.00	395GTZ
016 250 83 03	3960.30.00	395GTZ
016 250 84 03	3961.30.00	395GTZ
018 250 18 03	3960.30.00	395GTZ
018 250 91 01	4300.90.15	
018 250 92 03	3627.30.00	362WGTB
018 250 94 01	3620.90.02	
018 250 95 01	3950.90.01	
018 250 97 01	4000.90.04	
018 250 99 01	4300.90.15	
019 250 00 01	4300.90.15	
019 250 02 01	4300.90.381	
019 250 13 04	4022.10.00	MFZ2/400X
019 250 94 03	3960.30.00	395GTZ
019 250 95 03	3961.30.00	395GTZ
019 250 96 03	3960.30.00	395GTZ
019 250 97 03	3960.30.00	395GTZ
019 250 99 03	3961.30.00	395GTZ
020 250 00 03	3961.30.00	395GTZ
020 250 02 03	3960.30.00	395GTZ
020 250 03 03	3960.30.00	395GTZ
020 250 44 03	4351.30.00	430WGTZ
020 250 46 03	4351.30.00	430WGTZ
020 250 49 03	4352.30.00	430WGTZ
020 250 56 01	4300.90.15	
020 250 58 03	43460.30.00	430WGTZ
020 250 76 03	3971.30.00	395WGTZ
020 250 85 01	4300.90.15	
020 250 87 01	4300.90.381	
020 250 89 01	4300.90.15	
020 250 91 01	4300.90.381	
020 250 93 01	4300.90.381	
020 250 94 01	4300.90.90	
020 250 94 03	4025.30.00	400WGTZ
020 250 98 01	4025.30.00	400WGTZ
021 250 07 01	4000.90.04	

OEM reference	RUEN reference	Parameter
021 250 08 01	4300.90.15	
021 250 10 03	3960.30.00	395GTZ
021 250 19 01	4300.90.90	
021 250 20 01	4300.90.90	
021 250 21 01	4300.90.90	
021 250 22 01	4300.90.90	
021 250 25 01	3952.20.00	MF395
021 250 26 01	3950.90.21	
021 250 27 01	3950.90.21	
021 250 34 01	3620.90.02	
021 250 35 01	3620.90.02	
021 250 36 01	3950.90.01	
021 250 37 01	3950.90.01	
021 250 37 03	4351.30.00	430WGTZ
021 250 38 03	4351.30.00	430WGTZ
021 250 44 01	4300.90.381	
021 250 45 01	4300.90.381	
021 250 46 01	4300.90.381	
021 250 47 01	4300.90.381	
021 250 48 01	4300.90.382	
021 250 52 01	4340.60.00	MFZ430
021 250 53 01	4340.60.00	MFZ430
021 250 54 01	4300.90.90	
021 250 55 01	4300.90.90	
021 250 59 03	3960.30.00	395GTZ
021 250 60 01	4300.90.381	
021 250 60 03	3627.30.00	362WGTB
021 250 61 03	3627.30.00	362WGTB
021 250 64 01	4300.90.381	
021 250 64 03	3960.30.00	395GTZ
021 250 65 01	4300.90.381	
021 250 65 03	3960.30.00	395GTZ
021 250 66 01	4025.30.00	400WGTZ
021 250 66 03	3961.30.00	395GTZ
021 250 67 01	4025.30.00	400WGTZ
021 250 67 03	3961.30.00	395GTZ
021 250 68 01	4000.90.04	
021 250 68 03	3960.30.00	395GTZ
021 250 72 01	4300.90.90	
021 250 73 01	4300.90.90	
021 250 75 01	4000.90.17	
021 250 78 03	4351.30.00	430WGTZ
021 250 88 03	4351.30.00	430WGTZ
021 250 89 01	3950.90.01	
021 250 89 03	4351.30.00	430WGTZ
021 250 92 03	4351.30.00	430WGTZ
021 250 93 03	4351.30.00	430WGTZ
021 250 94 01	4300.90.15	
021 250 94 03	4352.30.00	430WGTZ
021 250 96 01	4300.90.381	
021 250 97 01	4300.90.15	
021 250 98 01	4300.90.90	
021 250 99 01	4300.90.90	
022 250 09 01	4300.90.15	
022 250 14 01	4300.90.381	
022 250 15 01	4300.90.15	
022 250 16 01	4300.90.90	
022 250 17 01	4300.90.381	
022 250 23 01	4340.60.00	MFZ430
022 250 26 01	4300.90.90	
022 250 30 01	4300.90.382	
022 250 32 03	3971.30.00	395WGTZ
022 250 39 01	4300.90.381	
022 250 43 01	4000.90.17	

Cross reference list

OEM reference	RUEN reference	Parameter
MERCEDES-BENZ >>		
022 250 44 01	4000.90.17	
022 250 48 01	4000.90.04	
022 250 49 01	4025.30.00	400WGTZ
022 250 52 01	4000.90.04	
022 250 57 01	4300.90.15	
022 250 58 01	3950.90.01	
022 250 59 01	3950.90.01	
022 250 60 01	3950.90.21	
022 250 61 01	3950.90.21	
022 250 81 01	3606.20.00	MF362
022 250 81 03	3960.30.00	395GTZ
022 250 82 03	3960.30.00	395GTZ
022 250 84 03	3971.30.00	395WGTZ
022 250 85 03	3971.30.00	395WGTZ
022 250 87 03	3961.30.00	395GTZ
022 250 88 03	3961.30.00	395GTZ
023 250 06 03	4352.30.00	430WGTZ
023 250 60 01	4000.90.18	MFZ2/400X
023 250 61 01	4000.90.18	MFZ2/400X
024 250 05 01	4300.90.15	
024 250 06 01	4300.90.15	
024 250 08 01	4300.90.15	
024 250 09 01	4300.90.381	
024 250 10 01	4300.90.381	
024 250 12 01	4300.90.381	
024 250 14 01	4300.90.381	
024 250 15 01	4300.90.381	
024 250 17 01	4300.90.381	
024 250 17 03	3627.30.00	362WGTB
024 250 21 01	4340.60.00	MFZ430
024 250 21 03	3627.30.00	362WGTB
024 250 22 01	4340.60.00	MFZ430
024 250 22 04	4300.90.90	
024 250 24 01	4340.60.00	MFZ430
024 250 25 01	4300.90.90	
024 250 26 01	4300.90.90	
024 250 28 01	4300.90.90	
024 250 37 01	4300.90.381	
024 250 38 01	4300.90.381	
024 250 40 01	4300.90.381	
024 250 41 01	4025.30.00	400WGTZ
024 250 42 01	4025.30.00	400WGTZ
024 250 44 01	4025.30.00	400WGTZ
024 250 45 01	4000.90.04	
024 250 46 01	4000.90.04	
024 250 48 01	4000.90.04	
024 250 49 01	4000.90.04	
024 250 51 01	4000.90.17	
024 250 52 01	4000.90.17	
024 250 56 01	4300.90.382	
024 250 57 01	4300.90.382	
024 250 72 03	4025.30.00	400WGTZ
024 250 73 03	4025.30.00	400WGTZ
024 250 75 01	4300.90.15	
025 250 23 01	3620.90.02	
025 250 25 01	3620.90.02	
025 250 41 03	4318.30.00	430WGTZ
025 250 41 03	4350.30.00	430WGTZ
025 250 42 03	4318.30.00	430WGTZ
025 250 42 03	4350.30.00	430WGTZ
025 250 44 03	4351.30.00	430WGTZ
025 250 45 03	4351.30.00	430WGTZ

OEM reference	RUEN reference	Parameter
025 250 46 03	4351.30.00	430WGTZ
025 250 47 03	4351.30.00	430WGTZ
025 250 50 03	4352.30.00	430WGTZ
025 250 84 01	4300.90.15	
025 250 85 01	4300.90.15	
025 250 87 01	4000.90.17	
026 250 09 03	4318.30.00	430WGTZ
026 250 09 03	4350.30.00	430WGTZ
026 250 10 03	4318.30.00	430WGTZ
026 250 10 03	4350.30.00	430WGTZ
026 250 11 03	4351.30.00	430WGTZ
026 250 12 03	4351.30.00	430WGTZ
026 250 13 03	4352.30.00	430WGTZ
026 250 14 03	4352.30.00	430WGTZ
026 250 36 01	4300.90.15	
026 250 37 01	4300.90.90	
026 250 41 01	4300.90.381	
026 250 42 01	4300.90.381	
026 250 43 01	4300.90.15	
026 250 44 01	4300.90.15	
026 250 45 01	4300.90.15	
026 250 48 01	4300.90.382	
026 250 49 01	4300.90.15	
026 250 50 01	4340.60.00	MFZ430
026 250 51 01	4300.90.90	
026 250 52 01	4300.90.90	
026 250 53 01	4300.90.15	
026 250 64 01	4300.90.381	
026 250 65 01	4300.90.381	
026 250 67 01	4300.90.382	
026 250 68 01	4300.90.15	
026 250 69 01	4300.90.15	
026 250 70 01	4340.60.00	MFZ430
026 250 78 01	4000.90.17	
026 250 79 01	4000.90.17	
026 250 81 01	4000.90.17	
026 250 85 01	4000.90.17	
026 250 91 01	4300.90.15	
026 250 92 01	4300.90.15	
026 250 93 01	4300.90.381	
026 250 94 01	4300.90.381	
026 250 95 01	4300.90.381	
026 250 96 01	4300.90.381	
026 250 97 01	4300.90.382	
026 250 98 01	4300.90.382	
027 250 01 01	4300.90.90	
027 250 02 01	4300.90.90	
027 250 09 01	4318.30.00	430WGTZ
027 250 09 01	4350.30.00	430WGTZ
027 250 10 01	4318.30.00	430WGTZ
027 250 10 01	4350.30.00	430WGTZ
027 250 11 01	4300.90.15	
027 250 12 01	4300.90.15	
027 250 13 01	4300.90.90	
027 250 14 01	4300.90.90	
027 250 16 01	4000.90.17	
027 250 17 01	4000.90.17	
028 250 12 01	4300.90.381	
028 250 13 01	4300.90.381	
028 250 14 01	4300.90.15	
028 250 15 01	4300.90.15	
028 250 18 01	4300.90.382	
028 250 19 01	4300.90.382	
028 250 20 01	4300.90.15	

Cross reference list

OEM reference	RUEN reference	Parameter
MERCEDES-BENZ >>		
028 250 21 01	4300.90.15	
028 250 24 01	4300.90.90	
028 250 25 01	4300.90.90	
028 250 26 01	4300.90.90	
028 250 27 01	4300.90.90	
028 250 34 01	4318.30.00	430WGTZ
028 250 34 01	4350.30.00	430WGTZ
028 250 35 01	4318.30.00	430WGTZ
028 250 35 01	4350.30.00	430WGTZ
304 252 05	3522.30.00	350GSZ
305 250 06 15	6915.40.00	KZI - 4
317 250 02 04	3807.20.00	G380KR
327 250 11 15	6915.40.00	KZI - 4
340 250 02 15	6909.40.00	KZI - 3
352 250 01 15	6909.40.00	KZI - 3
352 250 05 15	6909.40.00	KZI - 3
381 250 04 15	6901.40.00	KZI - 3
5024072	3102.20.00	GF310K
695 250 70 04	3580.20.00	GMF350
695 250 71 03	3583.30.00	350GSZ
A 000 250 41 04	3807.20.00	G380KR
A 000 250 81 04	2530.20.00	G250
A 000 250 92 15	9302.40.00	KZI-6
A 000 254 03 20	8603.47.00	HHIS-3
A 000 254 04 20	8603.47.00	HHIS-3
A 000 254 30 20	8603.47.00	HHIS-3
A 001 250 69 03	2538.30.00	250TPZ
A 001 250 87 04	2530.20.00	G250
A 001 250 97 01	4300.90.15	
A 002 250 19 15	8603.47.00	HHIS-3
A 002 250 21 15	8603.47.00	HHIS-3
A 002 250 22 15	8603.47.00	HHIS-3
A 002 250 24 15	8653.47.00	HHIS-3
A 002 250 25 15	8653.47.00	HHIS-3
A 002 250 27 15	8603.47.00	HHIS-3
A 002 250 28 15	8653.47.00	HHIS-3
A 002 250 29 15	8603.47.00	HHIS-3
A 002 250 30 15	8653.47.00	HHIS-3
A 002 250 31 15	8603.47.00	HHIS-3
A 002 250 43 03	2538.30.00	250TPZ
A 002 250 51 15	8603.47.00	HHIS-3
A 002 250 52 15	8653.47.00	HHIS-3
A 002 250 55 15	8601.47.00	
A 002 250 58 15	8602.47.00	
A 002 250 60 15	8604.47.00	
A 002 250 62 15	8653.47.00	HHIS-3
A 002 250 65 15	8540.40.00	KZIS-4
A 002 250 66 15	8603.47.00	HHIS-3
A 002 250 72 15	8653.47.00	HHIS-3
A 002 250 73 15	8601.47.00	
A 002 250 74 15	8602.47.00	
A 002 250 75 15	8604.47.00	
A 002 250 76 15	8653.47.00	HHIS-3
A 003 250 14 04	3807.20.00	G380KR
A 003 250 37 15	8947.40.00	KZISZ-5
A 003 250 39 03	2538.30.00	250TPZ
A 003 250 75 15	8947.40.00	KZISZ-5
A 005 250 64 04	4329.60.00	MFZ430
A 005 250 66 04	4329.60.00	MFZ430
A 005 250 70 03	2538.30.00	250TPZ
A 005 250 89 03	2538.30.00	250TPZ
A 006 250 47 04	4025.10.00	MFZ2/400X

OEM reference	RUEN reference	Parameter
A 006 250 48 04	4025.10.00	MFZ2/400X
A 006 250 49 04	4025.10.00	MFZ2/400X
A 006 250 86 04	4025.10.00	MFZ2/400X
A 006 250 87 04	4025.10.00	MFZ2/400X
A 006 250 88 04	4025.10.00	MFZ2/400X
A 007 250 23 04	3952.20.00	MF395
A 007 250 24 04	3952.20.00	MF395
A 007 250 28 04	4025.10.00	MFZ2/400X
A 007 250 29 04	4025.10.00	MFZ2/400X
A 007 250 30 04	4025.10.00	MFZ2/400X
A 007 250 32 04	4025.10.00	MFZ2/400X
A 007 250 33 04	4025.10.00	MFZ2/400X
A 007 250 34 04	4025.10.00	MFZ2/400X
A 007 250 40 04	43100.20.00	MFZ430E
A 007 250 44 04	4025.10.00	MFZ2/400X
A 007 250 47 04	4025.10.00	MFZ2/400X
A 007 250 50 04	43100.20.00	MFZ430E
A 007 250 51 04	4025.10.00	MFZ2/400X
A 007 250 57 04	4340.60.00	MFZ430
A 007 250 61 04	4329.60.00	MFZ430
A 007 250 62 04	43100.20.00	MFZ430E
A 007 250 80 04	4340.60.00	MFZ430
A 007 250 81 04	4329.60.00	MFZ430
A 007 250 82 04	4025.10.00	MFZ2/400X
A 007 250 95 04	43100.20.00	MFZ430E
A 008 250 10 04	4025.10.00	MFZ2/400X
A 008 250 13 04	4022.10.00	MFZ2/400X
A 008 250 19 04	4025.10.00	MFZ2/400X
A 008 250 24 04	4329.60.00	MFZ430
A 008 250 25 04	4340.60.00	MFZ430
A 008 250 30 04	4329.60.00	MFZ430
A 008 250 32 04	4340.60.00	MFZ430
A 008 250 35 04	4025.10.00	MFZ2/400X
A 008 250 36 04	4025.10.00	MFZ2/400X
A 008 250 38 04	4022.10.00	MFZ2/400X
A 008 250 39 04	4022.10.00	MFZ2/400X
A 008 250 42 04	4025.10.00	MFZ2/400X
A 008 250 92 04	4021.10.00	MFZ2/400X
A 008 250 93 04	4021.10.00	MFZ2/400X
A 009 250 01 03	3854.30.00	380GVZ
A 009 250 02 03	3854.30.00	380GVZ
A 009 250 05 04	4022.10.00	MFZ2/400X
A 009 250 08 04	4329.60.00	MFZ430
A 009 250 09 04	4340.60.00	MFZ430
A 009 250 10 04	4349.60.00	MFZ430
A 009 250 12 04	4022.10.00	MFZ2/400X
A 009 250 14 04	4025.10.00	MFZ2/400X
A 009 250 15 04	4025.10.00	MFZ2/400X
A 009 250 16 04	4025.10.00	MFZ2/400X
A 009 250 23 04	4025.10.00	MFZ2/400X
A 009 250 25 04	4025.10.00	MFZ2/400X
A 009 250 58 03	2538.30.00	250TPZ
A 009 250 59 03	2538.30.00	250TPZ
A 009 250 83 04	4329.60.00	MFZ430
A 009 250 85 04	4022.10.00	MFZ2/400X
A 010 250 07 04	4329.60.00	MFZ430
A 010 250 09 04	4349.60.00	MFZ430
A 010 250 10 04	4329.60.00	MFZ430
A 010 250 11 04	4340.60.00	MFZ430
A 010 250 13 04	4022.10.00	MFZ2/400X
A 010 250 15 04	4025.10.00	MFZ2/400X
A 010 250 17 04	4025.10.00	MFZ2/400X
A 010 250 65 03	3854.30.00	380GVZ
A 010 250 66 03	3854.30.00	380GVZ

Cross reference list

OEM reference	RUEN reference	Parameter
MERCEDES-BENZ >>		
A 010 250 67 03	3854.30.00	380GVZ
A 010 250 80 03	3854.30.00	380GVZ
A 011 250 65 03	3854.30.00	380GVZ
A 011 250 66 03	3854.30.00	380GVZ
A 011 250 67 03	3854.30.00	380GVZ
A 015 250 19 03	2548.30.00	250CD
A 015 250 46 03	3961.30.00	395GTZ
A 015 250 63 03	3961.30.00	395GTZ
A 015 250 68 03	3854.30.00	380GVZ
A 016 250 81 03	3960.30.00	395GTZ
A 016 250 82 03	3960.30.00	395GTZ
A 016 250 83 03	3960.30.00	395GTZ
A 016 250 84 03	3961.30.00	395GTZ
A 018 250 18 03	3960.30.00	395GTZ
A 018 250 91 01	4300.90.15	
A 018 250 92 03	3627.30.00	362WGTB
A 018 250 94 01	3620.90.02	
A 018 250 94 03	43460.30.00	430WGTTZ
A 018 250 95 01	3950.90.01	
A 018 250 97 01	4000.90.04	
A 018 250 99 01	4300.90.15	
A 019 250 00 01	4300.90.15	
A 019 250 02 01	4300.90.381	
A 019 250 13 04	4022.10.00	MFZ2/400X
A 019 250 66 03	43460.30.00	430WGTTZ
A 019 250 94 03	3960.30.00	395GTZ
A 019 250 95 03	3961.30.00	395GTZ
A 019 250 96 03	3960.30.00	395GTZ
A 019 250 97 03	3960.30.00	395GTZ
A 019 250 99 03	3961.30.00	395GTZ
A 020 250 00 03	3961.30.00	395GTZ
A 020 250 02 03	3960.30.00	395GTZ
A 020 250 03 03	3960.30.00	395GTZ
A 020 250 44 03	4351.30.00	430WGTTZ
A 020 250 46 03	4351.30.00	430WGTTZ
A 020 250 49 03	4352.30.00	430WGTTZ
A 020 250 56 01	4300.90.15	
A 020 250 76 03	3971.30.00	395WGTTZ
A 020 250 85 01	4300.90.15	
A 020 250 87 01	4300.90.381	
A 020 250 89 01	4300.90.15	
A 020 250 91 01	4300.90.381	
A 020 250 93 01	4300.90.381	
A 020 250 94 01	4300.90.90	
A 020 250 94 03	4025.30.00	400WGTTZ
A 020 250 98 01	4025.30.00	400WGTTZ
A 021 250 07 01	4000.90.04	
A 021 250 08 01	4300.90.15	
A 021 250 10 03	3960.30.00	395GTZ
A 021 250 19 01	4300.90.90	
A 021 250 20 01	4300.90.90	
A 021 250 21 01	4300.90.90	
A 021 250 22 01	4300.90.90	
A 021 250 25 01	3952.20.00	MF395
A 021 250 26 01	3950.90.21	
A 021 250 27 01	3950.90.21	
A 021 250 34 01	3620.90.02	
A 021 250 35 01	3620.90.02	
A 021 250 36 01	3950.90.01	
A 021 250 37 01	3950.90.01	
A 021 250 37 03	4351.30.00	430WGTTZ
A 021 250 38 03	4351.30.00	430WGTTZ

OEM reference	RUEN reference	Parameter
A 021 250 44 01	4300.90.381	
A 021 250 45 01	4300.90.381	
A 021 250 46 01	4300.90.381	
A 021 250 47 01	4300.90.381	
A 021 250 48 01	4300.90.382	
A 021 250 52 01	4340.60.00	MFZ430
A 021 250 53 01	4340.60.00	MFZ430
A 021 250 54 01	4300.90.90	
A 021 250 55 01	4300.90.90	
A 021 250 59 03	3960.30.00	395GTZ
A 021 250 60 01	4300.90.381	
A 021 250 60 03	3627.30.00	362WGTTB
A 021 250 61 03	3627.30.00	362WGTTB
A 021 250 64 01	4300.90.381	
A 021 250 64 03	3960.30.00	395GTZ
A 021 250 65 01	4300.90.381	
A 021 250 65 03	3960.30.00	395GTZ
A 021 250 66 01	4025.30.00	400WGTTZ
A 021 250 66 03	3961.30.00	395GTZ
A 021 250 67 01	4025.30.00	400WGTTZ
A 021 250 67 03	3961.30.00	395GTZ
A 021 250 68 01	4000.90.04	
A 021 250 68 03	3960.30.00	395GTZ
A 021 250 72 01	4300.90.90	
A 021 250 73 01	4300.90.90	
A 021 250 75 01	4000.90.17	
A 021 250 78 03	4351.30.00	430WGTTZ
A 021 250 88 03	4351.30.00	430WGTTZ
A 021 250 89 01	3950.90.01	
A 021 250 89 03	4351.30.00	430WGTTZ
A 021 250 92 03	4351.30.00	430WGTTZ
A 021 250 93 03	4351.30.00	430WGTTZ
A 021 250 94 01	4300.90.15	
A 021 250 94 03	4352.30.00	430WGTTZ
A 021 250 96 01	4300.90.381	
A 021 250 97 01	4300.90.15	
A 021 250 98 01	4300.90.90	
A 021 250 99 01	4300.90.90	
A 022 250 09 01	4300.90.15	
A 022 250 14 01	4300.90.381	
A 022 250 15 01	4300.90.15	
A 022 250 16 01	4300.90.90	
A 022 250 17 01	4300.90.381	
A 022 250 23 01	4340.60.00	MFZ430
A 022 250 26 01	4300.90.90	
A 022 250 30 01	4300.90.382	
A 022 250 32 03	3971.30.00	395WGTTZ
A 022 250 39 01	4300.90.381	
A 022 250 43 01	4000.90.17	
A 022 250 44 01	4000.90.17	
A 022 250 48 01	4000.90.04	
A 022 250 49 01	4025.30.00	400WGTTZ
A 022 250 52 01	4000.90.04	
A 022 250 58 01	3950.90.01	
A 022 250 59 01	3950.90.01	
A 022 250 60 01	3950.90.21	
A 022 250 61 01	3950.90.21	
A 022 250 81 01	3606.20.00	MF362
A 022 250 81 03	3960.30.00	395GTZ
A 022 250 82 03	3960.30.00	395GTZ
A 022 250 84 03	3971.30.00	395WGTTZ
A 022 250 85 03	3971.30.00	395WGTTZ
A 022 250 87 03	3961.30.00	395GTZ
A 022 250 88 03	3961.30.00	395GTZ

Cross reference list

OEM reference	RUEN reference	Parameter
MERCEDES-BENZ >>		
A 023 250 06 03	4352.30.00	430WGTZ
A 023 250 60 01	4000.90.18	MFZ2/400X
A 023 250 61 01	4000.90.18	MFZ2/400X
A 024 250 05 01	4300.90.15	
A 024 250 06 01	4300.90.15	
A 024 250 08 01	4300.90.15	
A 024 250 09 01	4300.90.381	
A 024 250 10 01	4300.90.381	
A 024 250 12 01	4300.90.381	
A 024 250 14 01	4300.90.381	
A 024 250 15 01	4300.90.381	
A 024 250 17 01	4300.90.381	
A 024 250 17 03	3627.30.00	362WGTB
A 024 250 21 01	4340.60.00	MFZ430
A 024 250 21 03	3627.30.00	362WGTB
A 024 250 22 01	4340.60.00	MFZ430
A 024 250 22 04	4300.90.90	
A 024 250 24 01	4340.60.00	MFZ430
A 024 250 25 01	4300.90.90	
A 024 250 26 01	4300.90.90	
A 024 250 28 01	4300.90.90	
A 024 250 37 01	4300.90.381	
A 024 250 38 01	4300.90.381	
A 024 250 40 01	4300.90.381	
A 024 250 41 01	4025.30.00	400WGTZ
A 024 250 42 01	4025.30.00	400WGTZ
A 024 250 44 01	4025.30.00	400WGTZ
A 024 250 45 01	4000.90.04	
A 024 250 46 01	4000.90.04	
A 024 250 48 01	4000.90.04	
A 024 250 49 01	4000.90.04	
A 024 250 51 01	4000.90.17	
A 024 250 52 01	4000.90.17	
A 024 250 56 01	4300.90.382	
A 024 250 57 01	4300.90.382	
A 024 250 72 03	4025.30.00	400WGTZ
A 024 250 73 03	4025.30.00	400WGTZ
A 024 250 75 01	4300.90.15	
A 025 250 23 01	3620.90.02	
A 025 250 25 01	3620.90.02	
A 025 250 41 03	4318.30.00	430WGTZ
A 025 250 41 03	4350.30.00	430WGTZ
A 025 250 42 03	4318.30.00	430WGTZ
A 025 250 42 03	4350.30.00	430WGTZ
A 025 250 44 03	4351.30.00	430WGTZ
A 025 250 45 03	4351.30.00	430WGTZ
A 025 250 46 03	4351.30.00	430WGTZ
A 025 250 47 03	4351.30.00	430WGTZ
A 025 250 50 03	4352.30.00	430WGTZ
A 025 250 84 01	4300.90.15	
A 025 250 85 01	4300.90.15	
A 025 250 87 01	4000.90.17	
A 026 250 09 03	4318.30.00	430WGTZ
A 026 250 09 03	4350.30.00	430WGTZ
A 026 250 10 03	4318.30.00	430WGTZ
A 026 250 10 03	4350.30.00	430WGTZ
A 026 250 11 03	4351.30.00	430WGTZ
A 026 250 12 03	4351.30.00	430WGTZ
A 026 250 13 03	4352.30.00	430WGTZ
A 026 250 14 03	4352.30.00	430WGTZ
A 026 250 36 01	4300.90.15	
A 026 250 37 01	4300.90.90	

OEM reference	RUEN reference	Parameter
A 026 250 41 01	4300.90.381	
A 026 250 42 01	4300.90.381	
A 026 250 43 01	4300.90.15	
A 026 250 44 01	4300.90.15	
A 026 250 45 01	4300.90.15	
A 026 250 48 01	4300.90.382	
A 026 250 49 01	4300.90.15	
A 026 250 50 01	4340.60.00	MFZ430
A 026 250 51 01	4300.90.90	
A 026 250 52 01	4300.90.90	
A 026 250 53 01	4300.90.15	
A 026 250 64 01	4300.90.381	
A 026 250 65 01	4300.90.381	
A 026 250 67 01	4300.90.382	
A 026 250 68 01	4300.90.15	
A 026 250 69 01	4300.90.15	
A 026 250 70 01	4340.60.00	MFZ430
A 026 250 78 01	4000.90.17	
A 026 250 79 01	4000.90.17	
A 026 250 81 01	4000.90.17	
A 026 250 85 01	4000.90.17	
A 026 250 91 01	4300.90.15	
A 026 250 92 01	4300.90.15	
A 026 250 93 01	4300.90.381	
A 026 250 94 01	4300.90.381	
A 026 250 95 01	4300.90.381	
A 026 250 96 01	4300.90.381	
A 026 250 97 01	4300.90.382	
A 026 250 98 01	4300.90.382	
A 027 250 01 01	4300.90.90	
A 027 250 02 01	4300.90.90	
A 027 250 09 01	4318.30.00	430WGTZ
A 027 250 09 01	4350.30.00	430WGTZ
A 027 250 10 01	4318.30.00	430WGTZ
A 027 250 10 01	4350.30.00	430WGTZ
A 027 250 11 01	4300.90.15	
A 027 250 12 01	4300.90.15	
A 027 250 13 01	4300.90.90	
A 027 250 14 01	4300.90.90	
A 027 250 16 01	4000.90.17	
A 027 250 17 01	4000.90.17	
A 028 250 12 01	4300.90.381	
A 028 250 13 01	4300.90.381	
A 028 250 14 01	4300.90.15	
A 028 250 15 01	4300.90.15	
A 028 250 18 01	4300.90.382	
A 028 250 19 01	4300.90.382	
A 028 250 20 01	4300.90.15	
A 028 250 21 01	4300.90.15	
A 028 250 24 01	4300.90.90	
A 028 250 25 01	4300.90.90	
A 028 250 26 01	4300.90.90	
A 028 250 27 01	4300.90.90	
A 028 250 34 01	4318.30.00	430WGTZ
A 028 250 34 01	4350.30.00	430WGTZ
A 028 250 35 01	4318.30.00	430WGTZ
A 028 250 35 01	4350.30.00	430WGTZ
A 317 250 02 04	3807.20.00	G380KR

NEOPLAN

0421.035.300	43460.30.00	430WGTZ
11010031	43460.30.00	430WGTZ

OTOKAR (TÜRKİYE)

Cross reference list

OEM reference	RUEN reference	Parameter
---------------	----------------	-----------

OTOKAR (TÜRKİYE) >>

13C0022005AC	3133.30.00	310GSBL
--------------	------------	---------

OTOYOL (TÜRKİYE)

30379	3133.30.00	310GSBL
46613084	3169.20.00	MF310
52795	3133.30.00	310GSBL
60148673	3113.30.00	310GSBL
8566183-V	2504.30.00	250CBL
98400708	3189.20.00	MFZ 310
HA2526	2514.20.00	H250K

PEUGEOT

2004 40	2185.20.00	CP215
2054.49	2198.30.00	215CE
2055.17	2198.30.00	215CE

RENAULT

20569137	4385.60.00	MFZ430
3192783	4385.60.00	MFZ430
7420 707 020	4385.60.00	MFZ430
7700 587 482	2034.30.00	200CE
7700 722 064	2185.20.00	CP215
7700 743 120	2034.30.00	200CE
7700 743 123	2023.20.00	DB200
7700 850 865	2023.20.00	DB200
85000251	4385.60.00	MFZ430

RENAULT (TÜRKİYE)

5000 677 165	4027.30.00	400WGVZ
5000 677 197	6905.40.00	KZIS - 3
5000 677 294	4028.30.00	400GTZ
5010 244 023	3162.20.00	MF310
5010 244 093	4026.10.00	MFZ2/400X
5010 244 144	3162.30.00	310GTD
5010 244 202	8937.40.00	KZIS-5
5010 244 203	4311.20.00	MFZ430
5010 244 204	8932.40.00	KZISZ - 5
5010 244 225	8940.40.00	KZISZ-5
5010 244 310	3574.20.00	14" MF 350
5010 245 447	4312.30.00	430W2GTZ
5010 245 448	4311.30.00	430W2GTZ
5010 245 921	8933.40.00	KZISZ - 5
5010 452 025	8941.40.00	KZISZ-5
5010 452 026	4029.30.00	400GTZ
5010 452 572	3896.30.00	380WGSZ
5010 452 822	8919.40.00	KZISZ - 5
5010 545 038	4306.30.00	430WGTZ
5010 545 852	4301.20.00	MFZ430

RENAULT TRUCKS

0001 144 060	4313.30.00	430WGTZ
0001 144 060	4343.30.00	430GTZ
0001 151 423	4313.30.00	430WGTZ
0001 151 423	4343.30.00	430GTZ
0001 151 857	3574.20.00	14" MF 350
0003 272 816	2525.20.00	MF250
0003 722 816	2525.20.00	MF250
0023 618 127	3173.20.00	MF310
23 618 037	3812.30.00	380GSZ
23 618 133	3866.20.00	GM380K
23 618 136	2822.20.00	MF280
23 618 190	3866.20.00	GM380K

OEM reference	RUEN reference	Parameter
---------------	----------------	-----------

23618 158	4298.30.00	420GSZ
5000 0041 314	3562.20.00	GMF350
5000 055 186	2525.20.00	MF250
5000 055 986	2525.20.00	MF250
5000 057 463	2520.30.00	250CB
5000 059 526	4312.30.00	430W2GTZ
5000 240 959	3835.20.00	GF380
5000 249 083	3574.20.00	14" MF 350
5000 251 352	3520.20.00	GF350KR
5000 273 555	3155.30.00	310Z
5000 278 449	3514.30.00	350WGSZ
5000 296 267	2520.30.00	250CB
5000 455 001	3563.20.00	GMF350
5000 534 738	3866.20.00	GM380K
5000 534 850	3562.20.00	GMF350
5000 534 850	3574.20.00	14" MF 350
5000 534 976	3570.30.00	350Z
5000 613 478	2822.20.00	MF280
5000 660 946	4342.30.00	430GTZ
5000 660 956	3574.20.00	14" MF 350
5000 667 054	4311.30.00	430W2GTZ
5000 677 001	4342.30.00	430GTZ
5000 677 053	4313.30.00	430WGTZ
5000 677 053	4343.30.00	430GTZ
5000 677 054	4342.30.00	430GTZ
5000 677 055	4313.30.00	430WGTZ
5000 677 055	4343.30.00	430GTZ
5000 677 135	4342.30.00	430GTZ
5000 677 138	4342.30.00	430GTZ
5000 677 154	4311.30.00	430W2GTZ
5000 677 165	4027.30.00	400WGVZ
5000 677 199	3173.20.00	MF310
5000 677 200	4342.30.00	430GTZ
5000 677 232	4036.10.00	MFZ2/400X
5000 677 243	4311.30.00	430W2GTZ
5000 677 249	4312.30.00	430W2GTZ
5000 677 250	4342.30.00	430GTZ
5000 677 251	4342.30.00	430GTZ
5000 677 254	4313.30.00	430WGTZ
5000 677 254	4343.30.00	430GTZ
5000 677 285	4313.30.00	430WGTZ
5000 677 285	4343.30.00	430GTZ
5000 677 295	4027.30.00	400WGVZ
5000 677 313	8938.46.00	
5000 677 328	4311.30.00	430W2GTZ
5000 788 292	4311.30.00	430W2GTZ
5000 788 292	4342.30.00	430GTZ
5000 788 573	3574.20.00	14" MF 350
5000 788 792	4342.30.00	430GTZ
5000 789 974	3574.20.00	14" MF 350
5000 789 975	3574.20.00	14" MF 350
5000 789 976	3574.20.00	14" MF 350
5000 790 959	4342.30.00	430GTZ
5000 826 290	2525.20.00	MF250
5000 826 314	3574.20.00	14" MF 350
5000 841 290	2525.20.00	MF250
5001 014 737	3574.20.00	14" MF 350
5001 677 232	4036.10.00	MFZ2/400X
5001 811 639	2650.90.15	
5001 821 908	4036.10.00	MFZ2/400X
5001 824 450	4313.30.00	430WGTZ
5001 824 450	4343.30.00	430GTZ
5001 824 733	4311.26.00	MFZ430
5001 825 886	4000.90.19	

Cross reference list

OEM reference	RUEN reference	Parameter
RENAULT TRUCKS >>		
5001 825 887	4000.90.19	
5001 825 889	4036.10.00	MFZ2/400X
5001 825 897	4000.90.19	
5001 830 909	4300.90.99	
5001 830 920	2525.20.00	MF250
5001 830 942	3500.90.42	
5001 843 357	4000.90.20	
5001 845 014	3500.90.42	
5001 848 241	3500.90.43	
5001 865 164	2650.90.15	
5001 865 764	3574.20.00	14" MF 350
5001 865 764	8526.40.00	KZI-4
5001 866 091	3500.90.42	
5001 866 103	4300.90.99	
5001 866 104	4300.90.99	
5001 866 621	8995.40.00	KZIZ-6
5001 867 227	4300.90.91	
5001 867 502	2650.90.15	
5001 867 644	3961.20.00	MF395
5001 868 260	2650.90.15	
5001 868 266	3500.90.43	
5001 868 271	4300.90.99	
5001 868 273	3500.90.42	
5001 868 279	3620.90.28	
5001 868 531	4300.90.117	
5001 872 322	3950.90.20	395
5001 872 324	3950.90.20	395
5010 244 091	4312.30.00	430W2GTZ
5010 244 091	4342.30.00	430GTZ
5010 244 304	4029.10.00	MFZ2/400X
5010 244 310	3574.20.00	14" MF 350
5010 244 390	8995.40.00	KZIZ-6
5010 245 267	2650.90.15	
5010 452 422	3961.20.00	MF395
5010 452 423	8544.40.00	
5010 545 582	4390.20.00	MFZ430
5010 545 747	3617.30.00	362WGTZ
5010 545 831	3973.30.00	395WGTZ
5010 545 836	4386.20.00	MFZ430
5010 545 851	4399.30.00	430WGTZ
5010 545 852	4313.20.00	MFZ430
5010 545 984	3620.20.00	MF362
5010 545 988	8543.40.00	KZIS-4
5010 613 151	3973.30.00	395WGTZ
5010 613 228	2650.90.15	
5010 613 658	4399.30.00	430WGTZ
5010 613 659	4395.20.00	MFZ430
5010 639 242	2650.90.15	
5516 021 253	3173.20.00	MF310
5800 207 048	3806.30.00	380W2GSZ
5800 207 049	4250.30.00	420WGSZ
5800 207 052	4224.20.00	GF420KR
74 21 071 024	8949.40.00	
7420 811 639	2650.90.15	
7420 846 567	3619.30.00	362WGTZ
7420 959 262	3973.30.00	395WGTZ
7420 981 951	3961.20.00	MF395
7421 074 314	4395.20.00	MFZ430
7421 188 863	8543.40.00	KZIS-4
7421 274 770	3974.30.00	395WGTZ
7421 580 956	8641.47.00	PHIS-6/38
7421 580 968	8641.47.00	PHIS-6/38

OEM reference	RUEN reference	Parameter
7421 916 049	3973.30.00	395WGTZ
7422 429 963	8641.47.00	PHIS-6/38
7485 003 687	8641.47.00	PHIS-6/38
7485 003 692	3620.90.29	
7485 003 694	4300.90.116	
7485 013 168	8641.47.00	PHIS-6/38
7485 013 826	3950.90.20	395
7485 013 829	3950.90.24	
7485 020 473	8641.47.00	PHIS-6/38
SCANIA		
0364378	4302.30.00	430GTZ
110 2488	4302.30.00	430GTZ
1102425	4263.20.00	GMF420K
1111148	4333.30.00	430WGTZ
1113870	4313.20.00	MFZ430
1123296	8631.47.00	HHISZ-4
130 2903	3878.30.00	380/210GSZ
130 4781	4302.30.00	430GTZ
131 8603	4302.30.00	430GTZ
1321253	4333.30.00	430WGTZ
1321254	4313.20.00	MFZ430
1321258	4333.30.00	430WGTZ
1321259	4313.20.00	MFZ430
1324883	4333.30.00	430WGTZ
1335280	4060.60.00	MFZ400X
1335281	4060.26.00	MFZ400X
1335282	4052.30.00	400GVZ
1340192	4333.30.00	430WGTZ
1341687	4328.20.00	MFZ430
1349349	4051.30.00	400WGVZ
1355282	4052.30.00	400GVZ
1356981	4060.26.00	MFZ400X
136 7172	4302.30.00	430GTZ
1361679	4313.20.00	MFZ430
1365486	4313.20.00	MFZ430
1368697	4333.30.00	430WGTZ
1370793	4313.20.00	MFZ430
1370794	4313.20.00	MFZ430
138 7021	4302.30.00	430GTZ
1382331	4328.20.00	MFZ430
1386931	4333.30.00	430WGTZ
1390374	4051.30.00	400WGVZ
1393161	8923.46.00	KZIZ-5
1393184	4060.60.00	MFZ400X
1393332	8631.47.00	HHISZ-4
1407430	8923.46.00	KZIZ-5
1407912	4378.20.00	MFZ430
1407913	4393.20.00	MFZ430
1412319	4333.30.00	430WGTZ
1413177	4051.30.00	400WGVZ
1434649	8631.47.00	HHISZ-4
1436695	4393.30.00	430WGTZ
1444110	4333.30.00	430WGTZ
1479576	8931.40.00	KZISZ-5
1479576	8934.40.00	KZISZ - 5
1496761	4392.30.00	430WGTZ
1499770	8931.40.00	KZISZ-5
1499770	8934.40.00	KZISZ - 5
1510032	4333.30.00	430WGTZ
1513718	4393.20.00	MFZ430
1513719	4313.20.00	MFZ430
1513720	4313.20.00	MFZ430
1521513	8948.40.00	KZIZ-5

Cross reference list

OEM reference	RUEN reference	Parameter
SCANIA >>		
1522377	8631.47.00	HHISZ-4
1522424	4393.20.00	MFZ430
1545062	8923.46.00	KZIZ-5
1548626	8948.40.00	KZIZ-5
1571220	4313.20.00	MFZ430
1574912	4392.30.00	430WGTZ
1728165	8931.40.00	KZISZ-5
1728165	8934.40.00	KZISZ - 5
1749124	4393.30.00	430WGTZ
1749125	8931.40.00	KZISZ-5
1749125	8934.40.00	KZISZ - 5
1851631	8931.40.00	KZISZ-5
1851631	8934.40.00	KZISZ - 5
1898019	4393.30.00	430WGTZ
1914989	4382.60.00	MFZ430
1914989	4394.20.00	MFZ430
1914991	4394.30.00	430WGTZ
2009984	4392.30.00	430WGTZ
2009987	4392.30.00	430WGTZ
2023015	4382.60.00	MFZ430
2023015	4394.20.00	MFZ430
2085861	4392.30.00	430WGTZ
2112315	4392.30.00	430WGTZ
2113315	4392.30.00	430WGTZ
2163969	4382.60.00	MFZ430
2163969	4394.20.00	MFZ430
2164195	8931.40.00	KZISZ-5
2164195	8934.40.00	KZISZ - 5
2189770	4394.30.00	430WGTZ
2274550	8931.40.00	KZISZ-5
2274550	8934.40.00	KZISZ - 5
2302249	4392.30.00	430WGTZ
234 680	4261.20.00	GMF420K
234 682	4263.20.00	GMF420K
254 902	4201.20.00	G420KR
264 078	4235.30.00	420/210GS
304 398	4261.30.00	420GSZ
314820	3878.30.00	380/210GSZ
315 428	4211.30.00	420/210GSZ
315 794	3878.30.00	380/210GSZ
327 557	4263.20.00	GMF420K
327557	4263.20.00	GMF420K
327577	4263.20.00	GMF420K
329439	4263.20.00	GMF420K
382499	4313.20.00	MFZ430
382576	4313.20.00	MFZ430
550501	4000.90.60	
550502	4000.90.61	
571 254	4302.30.00	430GTZ
571 268	4302.30.00	430GTZ
571 282	4302.30.00	430GTZ
571 289	4302.30.00	430GTZ
571217	4313.20.00	MFZ430
571218	4313.20.00	MFZ430
571220	4313.20.00	MFZ430
571221	4313.20.00	MFZ430
571222	4060.26.00	MFZ400X
571223	4052.30.00	400GVZ
571224	4051.30.00	400WGVZ
571226	4313.20.00	MFZ430
571227	4313.20.00	MFZ430
571268	4333.30.00	430WGTZ

OEM reference	RUEN reference	Parameter
571269	4378.20.00	MFZ430
571270	4393.30.00	430WGTZ
571271	4333.30.00	430WGTZ
571289	4328.20.00	MFZ430
571291	4051.30.00	400WGVZ
571296	4051.30.00	400WGVZ
571300	4333.30.00	430WGTZ
571310	4393.30.00	430WGTZ
571315	4393.20.00	MFZ430
571324	4393.20.00	MFZ430
571802	4000.90.60	
571803	4000.90.61	
572923	4394.30.00	430WGTZ
572943	4300.90.111	
572944	4300.90.212	
572947	4300.90.213	
572948	4300.90.111	
572949	4300.90.212	
572953	4300.90.113	
572954	4300.90.222	
572955	4300.90.09	
574859	4382.60.00	MFZ430
574859	4394.20.00	MFZ430
574864	4382.60.00	MFZ430
574864	4394.20.00	MFZ430
574865	4382.60.00	MFZ430
574865	4394.20.00	MFZ430
574867	4382.60.00	MFZ430
574867	4394.20.00	MFZ430
574868	4382.60.00	MFZ430
574868	4394.20.00	MFZ430
574908	4393.30.00	430WGTZ
574912	4392.30.00	430WGTZ
574914	4300.90.213	
574915	4300.90.111	
574916	4300.90.212	
574917	4300.90.112	
574918	4392.30.00	430WGTZ
574920	4300.90.232	
574923	4394.30.00	430WGTZ
574926	4392.30.00	430WGTZ
574981	4300.90.111	
574982	4300.90.214	
574983	4300.90.09	
6490375	4208.30.00	420GS

SCANIA (TÜRKİYE)

1102425	4263.20.00	GMF420K
1103482	4235.30.00	420/210GS
1104305	4261.20.00	GMF420K
1302903	3878.30.00	380/210GSZ
1304781	4321.30.00	430 WGTZ
1321259	4313.20.00	MFZ430
1324883	4333.30.00	430WGTZ
1341687	4328.20.00	MFZ430
1513720	4313.20.00	MFZ430
1728165	8934.40.00	KZISZ - 5
254902	4201.20.00	G420KR
394884	4263.20.00	GMF420K

STEYR

609 B16 0001	3131.20.00	G310
61200160010	3529.20.00	GF350KR
614160002	3506.20.00	G350

Cross reference list

OEM reference	RUEN reference	Parameter
---------------	----------------	-----------

STEYR



815 00 16 17	4240.30.00	420/210GSZ
81500160011	4258.30.00	420GSZ
81560160006	4250.20.00	GFX420KR
99114160020	4257.30.00	420GSZ

TAM

0002-158	2803.30.00	280BHZ
002-475	2803.20.00	G280
110-T10	7200.40.00	FKL - 306.770L
205 1104	6606.40.00	KFL - 555
247 5800	8500.40.00	KZI - 4,5
25010256	2803.20.00	G280
502 40 64	3102.30.00	310GSZ
5052220	3502.30.00	350GSZ
5095182	3502.20.00	G350KR
5190118	3802.20.00	G380KR
5190126	3802.30.00	380GSZ
525 3497	3857.30.00	380W2GSZ
533 6236	4250.30.00	420WGSZ
5409179	2821.30.00	280GTZ
55 992 16	6907.40.00	KZI - 3
5539630	2821.20.00	MF280K
5567 290	3130.30.00	310W2GSZ
5579 934	4253.20.00	GFX420KR
5582684	3166.20.00	MF310
5590 384	4268.30.00	420GSZ
5590 386	4236.20.00	GF420KR
5594 669	4235.20.00	GF420KR
5599 216	6907.40.00	KZI - 3
5601 007	3140.30.00	310W2GSZ
8751.52.01.06	2802.30.00	280BHZ
8751.52.51.36	3505.20.00	G350KR
8751-52-0130	2802.20.00	G280
8751-52-11.01	3540.20.00	LA350

TEMSA (TÜRKİYE)

81.30301.0492	3607.30.00	362WGTZ
81.30301.0505	4306.30.00	430WGTZ
81.30305.0232	3608.30.00	362WGTZ
81.30550.0109	8916.40.00	KZIZ - 5

VAN HOOL

100.901.513	4386.30.00	430WGTZ
10744609	43100.20.00	MFZ430E
10744649	43100.20.00	MFZ430E
109 96 028	43100.20.00	MFZ430E
10901513	4386.30.00	430WGTZ
11430376	4386.30.00	430WGTZ
518 312	4386.20.00	MFZ430

VOLVO

1521246	4055.30.00	400GVZ
1521719	4384.60.00	MFZ430
1526046	3528.30.00	350GSZ
1526047	3527.30.00	350GSZ
1527 693	8901.40.00	KZI - 5
1527474	3515.20.00	GF2/350
1655 334	38102.30.00	380GVZ
1655 335	38101.30.00	380GVZ
1655164	3590.30.00	350GSZ
1655406	3511.10.00	GF2/350
1655407	3516.10.00	GF2/350

OEM reference	RUEN reference	Parameter
---------------	----------------	-----------

1655648	3528.30.00	350GSZ
1655649	3527.30.00	350GSZ
1667928	3808.30.00	380GSZ
1667928	3839.30.00	380GSZ
1667929	3839.30.00	380GSZ
1667930	3561.30.00	350GSZ
1668 718	4203.20.00	G420KR
1668616	4305.20.00	MFZ430
1668667	4055.30.00	400GVZ
20504343	4386.20.00	MFZ430
20717563	4027.10.00	MFZ2/400X
20717564	4032.30.00	400WGTZ
20733540	4382.60.00	MFZ430
20733546	4382.60.00	MFZ430
20744252	4027.10.00	MFZ2/400X
20748154	4384.60.00	MFZ430
20754422	4382.60.00	MFZ430
21593944	4389.30.00	430WGTZ
21615276	4047.10.00	MFZ2/400X
267 042	3889.10.00	GF2/380
267 156	8901.40.00	KZI - 5
267 158	8900.40.00	KZI - 5
267 160	4211.20.00	G420KR
267 171	4257.20.00	GMF420K
267 236	3561.30.00	350GSZ
267 248	3860.20.00	GM380K
267 417	4254.30.00	420GSZ
267 444	3890.10.00	GF2/380
267 445	3849.20.00	G380KR
267 446	3839.30.00	380GSZ
267 490	3861.20.00	GM380
267142	3515.10.00	GF2/350
267143	3516.20.00	G350KR
267236	3561.30.00	350GSZ
267249	3886.30.00	380GSZ
3018128	4254.30.00	420GSZ
3018129	3515.20.00	GF2/350
3018130	3562.30.00	350GSZ
346 319	4203.20.00	G420KR
346 320	4254.30.00	420GSZ
348 842	8900.40.00	KZI - 5
354925	3530.30.00	350GSZ
355023	3886.30.00	380GSZ
355027	3803.20.00	G380KR
355156	3562.30.00	350GSZ
355176	3527.30.00	350GSZ
355177	3527.30.00	350GSZ
382860	3511.20.00	G350KR
3952874	3158.20.00	MF310
8112340	4055.30.00	400GVZ
8113237	3158.20.00	MF310
85000503	4300.90.106	
85000503	4382.60.00	MFZ430
85000510	4300.90.118	
85000511	4384.60.00	MFZ430
85000537	4382.60.00	MFZ430
85000773	4000.90.28	
85000775	4032.30.00	400WGTZ
85003904	4389.30.00	430WGTZ
85013892	4000.90.29	

VOLVO (TÜRKİYE)

1655687	38102.30.00	380GVZ
1667927	38101.30.00	380GVZ

Cross reference list

OEM reference	RUEN reference	Parameter
---------------	----------------	-----------

OEM reference	RUEN reference	Parameter
---------------	----------------	-----------

VOLVO (TÜRKİYE) >>

1667931	4212.30.00	420/210GSZ
1668372	3528.30.00	350GSZ
1668373	3527.30.00	350GSZ
20366591	4032.30.00	400WGTZ
20569126	4332.60.00	MFZ430
267171	4257.20.00	GMF420K
3018130	3531.30.00	350GSZ
3018131	3530.30.00	350GSZ
3191766	4325.30.00	430WGTZ
3191991	4331.30.00	430WGTZ
3192201	4333.60.00	MFZ430
8113812	4300.90.33	
8171496	4033.30.00	400WGTZ
8171497	4031.30.00	400GTZ
85000560	4300.90.35	

VW(VAG)

061 141 025A	2835.20.00	MFZ280
061 141 025D	3180.20.00	GMFZ310KR

WARTBURG

353.0.08.501.1	1801.20.00	T180120
530.0.08.500.0	1801.30.00	180DE2R

ZASTAVA

08566184	2514.20.00	H250K
162 47 59	2514.30.00	250CBL
1624760	2514.20.00	H250K
4 661 18 92	2514.30.00	250CBL
466 12 145	2810.30.00	280CBL
466 13 085	3113.30.00	310GSBL
46612180	2810.20.00	H280K
46613084	3169.20.00	MF310
8584017	2810.20.00	H280K
859 90 98	3113.30.00	310GSBL

Comparison list by manufacturer

Comparison refer.	RUEN reference	Parameter
-------------------	----------------	-----------

BORG&BEG

HA 2526	2514.20.00	H250K
HB 3113	2517.30.00	250
HB 5495	3179.20.00	MFZ310
HB4522	2172.30.00	215D
HE4521	2171.20.00	MF215K
HE5475	2353.20.00	MFZ235

LUK

122 0026 12	2171.20.00	MF215K
125 0002 20	2507.20.00	HBX250
128 0011 50	2810.20.00	H280K
128 0219 20	2837.20.00	MFZ280
131 0030 20	3101.20.00	GFX310
131 0223 50	3169.20.00	MF310
133 0205 20	3305.20.00	GMF330
135 0201 20	3580.20.00	GMF350
142 0028 20	4235.20.00	GF420KR
320 0178 10	2034.30.00	200CE
322 0148 10	2172.30.00	215D
323 0062 16	2281.30.00	228PSD
323 0127 16	2307.30.00	228CB
325 0002 26	2528.30.00	250BHZX
328 0110 50	2810.30.00	280CBL
331 0001 26	3124.30.00	310GSBL
335 0002 26	3519.30.00	350GSZ
338 0003 26	3821.30.00	380GSZ
338 0124 26	3896.30.00	380WGSZ
338 0125 26	3894.30.00	380GSZ
338 0139 20	3878.30.00	380/210GSZ
342 0011 26	4258.30.00	420GSZ
500 0008 20	6908.40.00	KZ - 3
500 0173 20	6901.40.00	KZI - 3

SACHS

1861 088 007	4203.30.00	420GS
1861 985 105	4286.30.00	420WGTZ
1898 917 585	3591.30.00	350WGTZ
3151 101 031	8514.40.00	KZI - 4,5
3482 000 187	3951.20.00	MF395
3482 112 032	4060.26.00	MFZ400X
3482 125 533	3601.20.00	MF362
1861 560 234	4286.30.00	420WGTZ
1878 002 730	4350.30.00	430WGTZ
1861 351 338	3806.30.00	380W2GSZ
1861 351 340	3806.30.00	380W2GSZ
1861 486 231	3806.30.00	380W2GSZ
1861 489 131	3835.30.00	380GTZ
1861 669 003	3806.30.00	380W2GSZ
1862 147 032	3806.30.00	380W2GSZ
1862 308 031	38109.30.00	380GTZ
1862 390 031	4007.30.00	400WGTZ
1862 491 031	3591.30.00	350WGTZ
1878 001 154	4249.30.00	420W2GSZ
1878 005 367	3512.30.00	350W2GSZ
1878 006 854	4392.30.00	430WGTZ
1878 039 831	43460.30.00	430WGTZ
1878 047 333	3607.30.00	362WGTZ
1878 048 741	3627.30.00	362WGTB
1881 041 656	3807.20.00	G380KR
3100 008 104	8938.46.00	
3151 169 031	8916.40.00	KZIZ - 5
3151 221 001	7451.40.00	KZIS-4
3400 117 101	4300.90.99	
3400 117 631	4000.90.20	

Comparison refer.	RUEN reference	Parameter
-------------------	----------------	-----------

3400 122 001	4300.50.09	
3400 700 304	4300.90.03	
3400 700 355	4000.90.17	
3400 700 371	4300.90.112	
3400 700 438	4300.90.116	
3400 700 446	4300.90.90	
3400 700 461	4300.90.110	
3400 700 463	4300.90.106	
3400 700 611	4300.90.112	
3400 710 004	4300.90.09	
3400 710 008	3620.90.42	
3400 710 011	3620.90.19	
3482 036 332	3184.20.00	MFZ310
3482 123 832	3952.20.00	MF395
3482 124 001	3574.20.00	14" MF 350
3499 377 832	3562.20.00	GMF350
1800 125 001	3500.90.51	
1800 125 201	2500.90.01	
1800 125 301	4200.90.16	
1800 125 301	4200.90.17	
1800 125 501	4200.90.03	
1850 280 049	2402.20.00	MF240
1850 280 683	2810.20.00	H280K
1850 280 784	2514.20.00	H250K
1850 281 829	2810.30.00	280CBL
1850 281 917	2514.30.00	250CBL
1850 282 653	5800.40.00	KZA - 2
1850 480 049	2402.20.00	MF240
1850 480 076	2185.20.00	CP215
1850 481 008	2402.30.00	240PSD
1859 170 204	3515.50.00	GF2-350
1859 212 001	3848.50.00	GF2/380
1859 250 100	3882.50.00	GF2/380
1859 250 101	3857.50.00	GF2/380
1859 250 102	3857.50.00	GF2/380
1860 039 027	2256.30.00	225Z
1860 049 056	2013.30.00	200S
1860 056 124	2517.30.00	250
1860 062 037	2812.30.00	280Z
1861 034 003	3552.30.00	350
1861 034 047	3552.30.00	350
1861 034 147	3552.30.00	350
1861 060 003	2802.30.00	280BHZ
1861 060 003	2803.30.00	280BHZ
1861 206 111	4203.30.00	420GS
1861 206 112	4208.30.00	420GS
1861 206 113	4209.30.00	420GS
1861 206 211	4203.30.00	420GS
1861 206 212	4208.30.00	420GS
1861 206 242	4208.30.00	420GS
1861 219 009	3822.30.00	380GSZ
1861 219 157	3822.30.00	380GSZ
1861 224 033	2518.30.00	250GSZ
1861 224 034	2518.30.00	250GSZ
1861 224 048	2518.30.00	250GSZ
1861 234 001	3588.30.00	350GSZ
1861 234 010	3588.30.00	350GSZ
1861 244 101	2518.30.00	250GSZ
1861 274 003	3502.30.00	350GSZ
1861 274 004	3502.30.00	350GSZ
1861 274 233	3502.30.00	350GSZ
1861 279 031	2954.30.00	295BHZ
1861 279 133	2954.30.00	295BHZ
1861 279 135	2954.30.00	295BHZ
1861 288 105	3519.30.00	350GSZ
1861 288 135	3519.30.00	350GSZ

Comparison list by manufacturer

Comparison refer.	RUEN reference	Parameter
SACHS >>		
1861 288 136	3519.30.00	350GSZ
1861 291 033	2528.30.00	250BHZX
1861 291 036	2528.30.00	250BHZX
1861 291 136	2528.30.00	250BHZX
1861 296 033	2819.30.00	280GSZ
1861 296 034	2819.30.00	280GSZ
1861 303 232	3124.30.00	310GSBL
1861 303 243	3126.30.00	310GSBL
1861 303 246	3124.30.00	310GSBL
1861 303 248	3124.30.00	310GSBL
1861 303 248	3126.30.00	310GSBL
1861 321 139	3812.30.00	380GSZ
1861 325 105	3563.30.00	350GSZ
1861 325 106	3564.30.00	350GSZ
1861 325 135	3563.30.00	350GSZ
1861 325 141	3564.30.00	350GSZ
1861 325 142	3563.30.00	350GSZ
1861 329 139	3812.30.00	380GSZ
1861 350 201	3512.30.00	350W2GSZ
1861 350 231	3512.30.00	350W2GSZ
1861 350 233	3512.30.00	350W2GSZ
1861 351 305	3805.30.00	380WGSZ
1861 351 341	3806.30.00	380W2GSZ
1861 351 342	3805.30.00	380WGSZ
1861 380 133	3530.30.00	350GSZ
1861 380 238	3530.30.00	350GSZ
1861 380 238	3589.30.00	350GTZ
1861 384 231	3117.30.00	310GSZ
1861 384 334	3117.30.00	310GSZ
1861 409 132	4203.30.00	420GS
1861 410 002	4231.30.00	420GSZ
1861 410 006	4258.30.00	420GSZ
1861 410 009	4234.30.00	420/210GSZ
1861 410 015	4257.30.00	420GSZ
1861 410 016	4258.30.00	420GSZ
1861 410 046	4232.30.00	420GSZ
1861 410 046	4258.30.00	420GSZ
1861 410 047	4231.30.00	420GSZ
1861 410 048	4257.30.00	420GSZ
1861 413 134	3872.30.00	380GSZ
1861 433 401	2400.30.00	240PSD
1861 435 333	3861.30.00	380W2GSZ
1861 435 334	3861.30.00	380W2GSZ
1861 437 002	3559.30.00	350GSZ
1861 437 034	3561.30.00	350GSZ
1861 437 104	3561.30.00	350GSZ
1861 437 106	3562.30.00	350GSZ
1861 437 236	3562.30.00	350GSZ
1861 437 337	3561.30.00	350GSZ
1861 438 203	3514.30.00	350WGSZ
1861 438 204	3516.30.00	350WGSZ
1861 438 233	3514.30.00	350WGSZ
1861 438 234	3516.30.00	350WGSZ
1861 438 235	3514.30.00	350WGSZ
1861 443 102	4248.30.00	420W2GSZ
1861 460 138	3885.30.00	380GSZ
1861 470 133	3899.30.00	380GSZ
1861 470 234	3899.30.00	380GSZ
1861 480 331	4283.30.00	420WGSZ
1861 480 335	4283.30.00	420WGSZ
1861 482 034	4255.30.00	420GS
1861 486 202	3806.30.00	380W2GSZ
1861 486 231	3857.30.00	380W2GSZ
1861 486 232	3806.30.00	380W2GSZ

Comparison refer.	RUEN reference	Parameter
1861 486 233	3806.30.00	380W2GSZ
1861 486 234	3806.30.00	380W2GSZ
1861 488 131	3871.30.00	380/70GSZ
1861 488 140	3871.30.00	380/70GSZ
1861 489 101	3870.30.00	380/210GSZ
1861 489 133	3835.30.00	380GTZ
1861 489 139	3835.30.00	380GTZ
1861 489 235	3510.30.00	350W2GSZ
1861 494 103	3821.30.00	380GSZ
1861 494 140	3821.30.00	380GSZ
1861 498 202	3510.30.00	350W2GSZ
1861 498 232	3510.30.00	350W2GSZ
1861 498 235	3510.30.00	350W2GSZ
1861 515 332	2281.30.00	228PSD
1861 521 231	4249.30.00	420W2GSZ
1861 521 234	4249.30.00	420W2GSZ
1861 526 003	4291.30.00	420GSZ
1861 526 014	4291.30.00	420GSZ
1861 526 037	4298.30.00	420GSZ
1861 526 046	4286.30.00	420WGTZ
1861 527 002	4244.30.00	420/210GSZ
1861 527 033	4244.30.00	420/210GSZ
1861 531 002	3522.30.00	350GSZ
1861 535 001	3102.30.00	310GSZ
1861 543 535	2157.30.00	215PSD
1861 545 131	4286.30.00	420WGTZ
1861 545 133	4286.30.00	420WGTZ
1861 557 103	2306.30.00	228GSB
1861 557 233	2306.30.00	228GSB
1861 557 235	2306.30.00	228GSB
1861 557 236	2306.30.00	228GSB
1861 557 237	2307.30.00	228CB
1861 560 204	4268.30.00	420GSZ
1861 560 232	4286.30.00	420WGTZ
1861 560 234	4268.30.00	420GSZ
1861 569 031	4236.30.00	420/210GSZ
1861 569 038	4236.30.00	420/210GSZ
1861 571 101	3300.30.00	330GSZ
1861 571 131	3300.30.00	330GSZ
1861 571 236	3300.30.00	330GSZ
1861 572 431	4299.30.00	420GSZ
1861 577 037	3113.30.00	310GSBL
1861 577 037	3162.30.00	310GTD
1861 577 136	3113.30.00	310GSBL
1861 579 131	3816.30.00	380GSZ
1861 584 036	3839.30.00	380GSZ
1861 584 108	3835.30.00	380GTZ
1861 584 137	3839.30.00	380GSZ
1861 594 034	3321.30.00	330GSB
1861 598 103	4261.30.00	420GSZ
1861 598 133	4261.30.00	420GSZ
1861 599 102	3852.30.00	380GS
1861 600 033	3108.30.00	310GSZ
1861 611 031	2805.30.00	280BHZ
1861 611 131	2805.30.00	280BHZ
1861 620 233	2307.30.00	228CB
1861 620 234	2307.30.00	228CB
1861 632 032	2822.30.00	280GTZ
1861 635 031	3886.30.00	380GSZ
1861 635 035	3886.30.00	380GSZ
1861 639 004	4250.30.00	420WGSZ
1861 639 006	4250.30.00	420WGSZ
1861 639 031	4250.30.00	420WGSZ
1861 639 032	4250.30.00	420WGSZ
1861 639 035	4250.30.00	420WGSZ
1861 639 107	4250.30.00	420WGSZ

Comparison list by manufacturer

Comparison refer.	RUEN reference	Parameter
SACHS >>		
1861 639 148	4250.30.00	420WGSZ
1861 640 031	3527.30.00	350GSZ
1861 640 135	3527.30.00	350GSZ
1861 641 031	3528.30.00	350GSZ
1861 641 135	3528.30.00	350GSZ
1861 642 131	2832.30.00	280GTZ
1861 642 133	2832.30.00	280GTZ
1861 643 134	4289.30.00	420GSZ
1861 646 133	3808.30.00	380GSZ
1861 653 102	3140.30.00	310W2GSZ
1861 663 001	4240.30.00	420/210GSZ
1861 663 002	4247.30.00	420GSZ
1861 663 033	4247.30.00	420GSZ
1861 667 034	3310.30.00	330GSZ
1861 669 001	3806.30.00	380W2GSZ
1861 669 002	3806.30.00	380W2GSZ
1861 670 002	4261.30.00	420GSZ
1861 672 031	4254.30.00	420GSZ
1861 672 033	4254.30.00	420GSZ
1861 678 002	3577.30.00	350WGSZ
1861 680 002	4261.30.00	420GSZ
1861 680 036	4261.30.00	420GSZ
1861 680 037	4261.30.00	420GSZ
1861 680 038	4235.30.00	420/210GS
1861 680 107	4261.30.00	420GSZ
1861 680 149	4261.30.00	420GSZ
1861 695 031	3589.30.00	350GTZ
1861 695 032	3589.30.00	350GTZ
1861 699 101	3892.30.00	380GSZ
1861 699 103	3835.30.00	380GTZ
1861 699 109	3835.30.00	380GTZ
1861 699 131	3892.30.00	380GSZ
1861 714 133	3575.30.00	350WGSZ
1861 715 032	4272.30.00	420WGSZ
1861 715 035	4272.30.00	420WGSZ
1861 724 003	4278.30.00	420W2GSZ
1861 724 104	4278.30.00	420W2GSZ
1861 724 137	4278.30.00	420W2GSZ
1861 732 031	2400.30.00	240PSD
1861 742 032	3585.30.00	350GSZ
1861 748 101	3894.30.00	380GSZ
1861 748 132	3894.30.00	380GSZ
1861 749 101	3896.30.00	380WGSZ
1861 749 102	3896.30.00	380WGSZ
1861 749 132	3896.30.00	380WGSZ
1861 760 034	4212.30.00	420/210GSZ
1861 760 034	4266.30.00	420/210GSZ
1861 762 101	4211.30.00	420/210GSZ
1861 762 133	4211.30.00	420/210GSZ
1861 775 035	2281.30.00	228PSD
1861 777 037	3563.30.00	350GSZ
1861 777 041	3563.30.00	350GSZ
1861 777 043	3564.30.00	350GSZ
1861 778 002	3328.30.00	330WGSZ
1861 778 003	3328.30.00	330WGSZ
1861 778 031	3328.30.00	330WGSZ
1861 787 004	3583.30.00	350GSZ
1861 787 031	3583.30.00	350GSZ
1861 787 034	3583.30.00	350GSZ
1861 792 235	2157.30.00	215PSD
1861 799 101	3878.30.00	380/210GSZ
1861 799 131	3878.30.00	380/210GSZ
1861 799 133	3878.30.00	380/210GSZ
1861 840 133	2538.30.00	250TPZ

Comparison refer.	RUEN reference	Parameter
1861 852 001	4210.30.00	420/210GSZ
1861 852 032	4210.30.00	420/210GSZ
1861 856 132	2281.30.00	228PSD
1861 857 132	2172.30.00	215D
1861 860 131	4299.30.00	420GSZ
1861 861 031	3816.30.00	380GSZ
1861 861 032	3816.30.00	380GSZ
1861 862 233	3871.30.00	380/70GSZ
1861 863 233	3835.30.00	380GTZ
1861 863 233	3870.30.00	380/210GSZ
1861 866 032	3585.30.00	350GSZ
1861 869 042	2045.30.00	200D
1861 874 031	3328.30.00	330WGSZ
1861 874 032	3328.30.00	330WGSZ
1861 876 033	4287.30.00	420GVZ
1861 876 134	4287.30.00	420GVZ
1861 903 002	4291.30.00	420GSZ
1861 903 032	4291.30.00	420GSZ
1861 903 033	4291.30.00	420GSZ
1861 903 034	4292.30.00	420GSZ
1861 906 032	38101.30.00	380GVZ
1861 907 132	38102.30.00	380GVZ
1861 911 232	4281.30.00	420WGVZ
1861 911 245	4281.30.00	420WGVZ
1861 911 303	4281.30.00	420WGVZ
1861 912 034	3897.30.00	380GSZ
1861 912 035	3897.30.00	380GSZ
1861 919 031	2822.30.00	280GTZ
1861 919 032	2822.30.00	280GTZ
1861 919 033	2822.30.00	280GTZ
1861 919 034	2822.30.00	280GTZ
1861 919 134	2822.30.00	280GTZ
1861 923 002	3888.30.00	380WGSZ
1861 923 003	3806.30.00	380W2GSZ
1861 923 032	3888.30.00	380WGSZ
1861 923 103	3806.30.00	380W2GSZ
1861 927 232	4343.30.00	430GTZ
1861 932 003	3835.30.00	380GTZ
1861 932 005	3835.30.00	380GTZ
1861 936 031	2281.30.00	228PSD
1861 936 042	2281.30.00	228PSD
1861 936 142	2281.30.00	228PSD
1861 936 142	2306.30.00	228GSB
1861 941 032	4297.30.00	420GSZ
1861 941 033	4297.30.00	420GSZ
1861 942 033	3806.30.00	380W2GSZ
1861 957 231	3590.30.00	350GSZ
1861 958 231	3589.30.00	350GTZ
1861 961 033	3597.30.00	350 WGTZ
1861 962 033	3517.30.00	350WGSZ
1861 963 033	3325.30.00	330WGSZ
1861 964 034	3136.30.00	310WGSZ
1861 971 141	4309.30.00	430WGVZ
1861 971 141	4342.30.00	430GTZ
1861 980 033	4287.30.00	420GVZ
1861 986 135	4244.30.00	420/210GSZ
1861 986 135	4256.30.00	420GS
1861 986 140	4259.30.00	420GSZ
1861 988 031	4335.30.00	430GTZ
1861 988 034	4335.30.00	430GTZ
1861 992 432	4327.30.00	430GTZ
1861 996 034	38101.30.00	380GVZ
1861 996 137	38101.30.00	380GVZ
1861 997 034	38102.30.00	380GVZ
1861 997 137	38102.30.00	380GVZ
1861 997 137	38105.30.00	380GTZ

Comparison list by manufacturer

Comparison refer.	RUEN reference	Parameter
SACHS >>		
1861 999 221	2821.30.00	280GTZ
1861 999 398	3130.30.00	310W2GSZ
1862 039 015	2805.30.00	280BHZ
1862 060 032	2827.30.00	280Z
1862 088 131	2260.30.00	225BHZ
1862 108 031	4346.30.00	430WGTZ
1862 108 034	4346.30.00	430WGTZ
1862 109 034	4346.30.00	430WGTZ
1862 122 031	3889.30.00	380GSZ
1862 122 131	3889.30.00	380GSZ
1862 122 132	3889.30.00	380GSZ
1862 122 134	3889.30.00	380GSZ
1862 123 131	3891.30.00	380GS
1862 126 032	4247.30.00	420GSZ
1862 133 032	4290.30.00	420GSZ
1862 133 033	4290.30.00	420GSZ
1862 135 003	3855.30.00	380GS
1862 135 035	3855.30.00	380GS
1862 138 032	3882.30.00	380GSZ
1862 157 037	4009.30.00	400WGVZ
1862 176 034	4302.30.00	430GTZ
1862 188 032	4305.30.00	430W2GTZ
1862 190 105	4021.30.00	400GVZ
1862 190 139	4025.30.00	400WGTZ
1862 193 105	4020.30.00	400GVZ
1862 208 001	4343.30.00	430GTZ
1862 208 032	4310.30.00	430WGVZ
1862 208 032	4343.30.00	430GTZ
1862 215 032	4305.30.00	430W2GTZ
1862 216 032	4304.30.00	430WGTZ
1862 216 032	4312.30.00	430W2GTZ
1862 217 032	4346.30.00	430WGTZ
1862 217 033	4346.30.00	430WGTZ
1862 217 235	4346.30.00	430WGTZ
1862 217 335	4346.30.00	430WGTZ
1862 217 337	4346.30.00	430WGTZ
1862 220 032	4286.30.00	420WGTZ
1862 226 131	4356.30.00	430WGTZ
1862 226 346	4356.30.00	430WGTZ
1862 226 511	4356.30.00	430WGTZ
1862 227 034	4281.30.00	420WGVZ
1862 235 001	38115.30.00	380GSZ
1862 236 031	3587.30.00	350GSZ
1862 243 033	3854.30.00	380GVZ
1862 243 035	3854.30.00	380GVZ
1862 268 031	4289.30.00	420GSZ
1862 273 031	4211.30.00	420/210GSZ
1862 273 131	4211.30.00	420/210GSZ
1862 283 133	4305.30.00	430W2GTZ
1862 299 032	3136.30.00	310WGSZ
1862 302 031	4011.30.00	400GVZ
1862 303 031	4010.30.00	400WGVZ
1862 305 033	3854.30.00	380GVZ
1862 305 034	3854.30.00	380GVZ
1862 307 031	2858.30.00	280GTZ
1862 307 032	2858.30.00	280GTZ
1862 307 132	2858.30.00	280GTZ
1862 308 031	3821.30.00	380GSZ
1862 310 132	3315.30.00	330GS
1862 315 101	4300.30.00	430GTZ
1862 317 031	4005.30.00	400GVZ
1862 317 032	4006.30.00	400GVZ
1862 326 031	4321.30.00	430 WGTZ
1862 326 032	4333.30.00	430WGTZ

Comparison refer.	RUEN reference	Parameter
1862 347 131	2413.30.00	240TD
1862 349 031	4055.30.00	400GVZ
1862 353 041	2520.30.00	250CB
1862 356 031	3806.30.00	380W2GSZ
1862 356 031	3888.30.00	380WGSZ
1862 364 031	4009.30.00	400WGVZ
1862 364 133	4008.30.00	400 WGVZ
1862 379 031	4027.30.00	400WGVZ
1862 379 032	4029.30.00	400GTZ
1862 385 201	3163.30.00	310GTD
1862 418 031	4356.30.00	430WGTZ
1862 419 101	4346.30.00	430WGTZ
1862 438 031	3309.30.00	330GSZ
1862 438 032	3309.30.00	330GSZ
1862 441 031	43460.30.00	430WGTZ
1862 441 131	43460.30.00	430WGTZ
1862 449 031	2858.30.00	280GTZ
1862 450 031	4052.30.00	400GVZ
1862 454 031	4051.30.00	400WGVZ
1862 461 031	4333.30.00	430WGTZ
1862 461 132	4333.30.00	430WGTZ
1862 491 031	3596.30.00	350WGSZ
1862 494 031	4356.30.00	430WGTZ
1862 506 131	3951.30.00	395WGTZ
1862 514 031	4037.30.00	400WGTZ
1862 519 034	4318.30.00	430WGTZ
1862 519 034	4350.30.00	430WGTZ
1862 519 137	4305.30.00	430W2GTZ
1862 519 139	4318.30.00	430WGTZ
1862 519 139	4350.30.00	430WGTZ
1862 519 240	4318.30.00	430WGTZ
1862 519 240	4350.30.00	430WGTZ
1862 519 259	4305.30.00	430W2GTZ
1862 528 032	3610.30.00	362GTZ
1862 529 032	4351.30.00	430WGTZ
1862 530 231	4323.30.00	430WGTZ
1862 541 031	3610.30.00	362GTZ
1862 541 032	3610.30.00	362GTZ
1862 588 003	4293.30.00	420GSZ
1862 588 004	4293.30.00	420GSZ
1862 722 001	2810.30.00	280CBL
1862 722 001	2832.30.00	280GTZ
1862 757 001	2157.30.00	215PSD
1862 768 001	1801.30.00	180DE2R
1862 811 001	2656.30.00	270CTB
1862 867 004	2034.30.00	200CE
1862 909 141	2178.30.00	215CE
1862 930 001	2198.30.00	215CE
1862 935 001	2178.30.00	215CE
1862 936 142	2281.30.00	228PSD
1862 954 142	2080.30.00	200VTB
1862 967 001	2655.30.00	265TB
1862 967 002	2514.30.00	250CBL
1862 977 001	2402.30.00	240PSD
1864 040 017	2844.30.00	280Z
1864 087 036	3155.30.00	310Z
1864 202 035	2510.30.00	250Z
1864 202 035	2517.30.00	250
1864 246 437	2510.30.00	250Z
1864 279 033	2954.30.00	295BHZ
1864 351 006	3570.30.00	350Z
1864 454 101	3571.30.00	350
1878 000 036	3952.30.00	395WGTZ
1878 000 055	4316.30.00	430WGTZ
1878 000 055	4356.30.00	430WGTZ
1878 000 104	3812.30.00	380GSZ

Comparison list by manufacturer

Comparison refer.	RUEN reference	Parameter
SACHS >>		
1878 000 104	3822.30.00	380GSZ
1878 000 105	38107.30.00	380 GTZ
1878 000 105	3821.30.00	380GSZ
1878 000 105	3852.30.00	380GS
1878 000 105	3885.30.00	380GSZ
1878 000 105	3897.30.00	380GSZ
1878 000 116	4305.30.00	430W2GTZ
1878 000 117	4351.30.00	430WGTZ
1878 000 205	4332.30.00	430GTZ
1878 000 206	4335.30.00	430GTZ
1878 000 294	3954.30.00	395WGTZ
1878 000 296	3953.30.00	395WGTZ
1878 000 299	4318.30.00	430WGTZ
1878 000 299	4350.30.00	430WGTZ
1878 000 300	4032.30.00	400WGTZ
1878 000 611	3132.30.00	310GSB
1878 000 634	4325.30.00	430WGTZ
1878 000 635	4031.30.00	400GTZ
1878 000 841	3596.30.00	350WGSZ
1878 000 884	2198.30.00	215CE
1878 000 948	4329.30.00	430WGTZ.
1878 000 957	38115.30.00	380GSZ
1878 000 957	3816.30.00	380GSZ
1878 000 959	3816.30.00	380GSZ
1878 000 961	3886.30.00	380GSZ
1878 000 964	3871.30.00	380/70GSZ
1878 000 965	3808.30.00	380GSZ
1878 000 967	3835.30.00	380GTZ
1878 000 967	3870.30.00	380/210GSZ
1878 000 968	3892.20.00	GF2/380
1878 001 030	4313.30.00	430WGTZ
1878 001 030	4346.30.00	430WGTZ
1878 001 070	3564.30.00	350GSZ
1878 001 070	3583.30.00	350GSZ
1878 001 070	3599.30.00	350 GTZ
1878 001 071	3563.30.00	350GSZ
1878 001 074	3502.30.00	350GSZ
1878 001 074	3519.30.00	350GSZ
1878 001 074	3588.30.00	350GSZ
1878 001 077	3585.30.00	350GSZ
1878 001 077	3587.30.00	350GSZ
1878 001 078	3564.30.00	350GSZ
1878 001 079	3530.30.00	350GSZ
1878 001 079	3589.30.00	350GTZ
1878 001 080	3527.30.00	350GSZ
1878 001 082	3561.30.00	350GSZ
1878 001 083	3531.30.00	350GSZ
1878 001 083	3559.30.00	350GSZ
1878 001 136	4297.30.00	420GSZ
1878 001 138	4208.30.00	420GS
1878 001 144	3510.30.00	350W2GSZ
1878 001 144	3517.30.00	350WGSZ
1878 001 144	3597.30.00	350 WGTZ
1878 001 145	3591.30.00	350WGTZ
1878 001 145	3596.30.00	350WGSZ
1878 001 147	3575.30.00	350WGSZ
1878 001 152	3806.30.00	380W2GSZ
1878 001 152	38106.30.00	380WGTZ
1878 001 152	3857.30.00	380W2GSZ
1878 001 154	4249.30.00	420W2GSZ
1878 001 155	4283.30.00	420WGSZ
1878 001 215	4325.30.00	430WGTZ
1878 001 501	3612.30.00	362GTZ
1878 001 729	3571.30.00	350

Comparison refer.	RUEN reference	Parameter
1878 001 938	4386.30.00	430WGTZ
1878 002 019	4025.30.00	400WGTZ
1878 002 023	4026.30.00	400GTZ
1878 002 024	4025.30.00	400WGTZ
1878 002 071	3611.30.00	362GTZ
1878 002 072	2354.30.00	235CBL
1878 002 139	4386.30.00	430WGTZ
1878 002 437	4033.30.00	400WGTZ
1878 002 442	4031.30.00	400GTZ
1878 002 455	4037.30.00	400WGTZ
1878 002 504	4331.30.00	430WGTZ
1878 002 599	3613.30.00	362GTZ
1878 002 643	4036.30.00	400 WGTZ
1878 002 729	4305.30.00	430W2GTZ
1878 002 730	4318.30.00	430WGTZ
1878 002 730	4350.30.00	430WGTZ
1878 002 732	4351.30.00	430WGTZ
1878 002 733	4331.30.00	430WGTZ
1878 002 955	4286.30.00	420WGTZ
1878 003 065	4393.30.00	430WGTZ
1878 003 066	4333.30.00	430WGTZ
1878 003 238	4261.30.00	420GSZ
1878 003 276	4291.30.00	420GSZ
1878 003 365	4211.30.00	420/210GSZ
1878 003 647	4332.30.00	430GTZ
1878 003 657	4250.30.00	420WGSZ
1878 003 657	4272.30.00	420WGSZ
1878 003 767	4338.30.00	430WGTZ
1878 003 768	4032.30.00	400WGTZ
1878 003 784	3961.30.00	395GTZ
1878 003 867	4329.30.00	430WGTZ.
1878 003 868	4389.30.00	430WGTZ
1878 003 968	4399.30.00	430WGTZ
1878 003 969	4392.30.00	430WGTZ
1878 004 132	4390.30.00	430WGTZ
1878 004 232	3971.30.00	395WGTZ
1878 004 573	43134.30.00	430WGTZ
1878 004 581	4339.30.00	430WGTZ
1878 004 832	4305.30.00	430W2GTZ
1878 004 832	4346.30.00	430WGTZ
1878 004 832	43461.30.00	430WGTZ
1878 005 031	4025.30.00	400WGTZ
1878 005 165	4318.30.00	430WGTZ
1878 005 165	4350.30.00	430WGTZ
1878 005 367	3512.30.00	350W2GSZ
1878 005 367	3516.30.00	350WGSZ
1878 005 411	4387.30.00	430WGTZ
1878 005 541	43461.30.00	430WGTZ
1878 005 668	4304.30.00	430WGTZ
1878 005 805	4020.30.00	400GVZ
1878 006 035	38105.30.00	380GTZ
1878 006 101	4352.30.00	430WGTZ
1878 006 117	38104.30.00	380GTZ
1878 006 129	4389.30.00	430WGTZ
1878 006 584	4329.30.00	430WGTZ.
1878 006 713	3957.30.00	395WGTZ
1878 006 847	3617.30.00	362WGTZ
1878 006 848	3619.30.00	362WGTZ
1878 007 046	4398.30.00	430WGTZ
1878 007 072	4318.30.00	430WGTZ
1878 007 072	4350.30.00	430WGTZ
1878 007 120	4392.30.00	430WGTZ
1878 007 123	4392.30.00	430WGTZ
1878 007 124	4394.30.00	430WGTZ
1878 007 172	35101.30.00	350WGTZ
1878 007 185	4025.30.00	400WGTZ

Comparison list by manufacturer

Comparison refer.	RUEN reference	Parameter
SACHS >>		
1878 007 254	4394.30.00	430WGTZ
1878 007 279	3953.30.00	395WGTZ
1878 007 339	38109.30.00	380GTZ
1878 007 939	3974.30.00	395WGTZ
1878 013 031	4051.30.00	400WGVZ
1878 013 132	4051.30.00	400WGVZ
1878 019 001	3613.30.00	362GTZ
1878 020 241	4311.30.00	430W2GTZ
1878 022 841	4305.30.00	430W2GTZ
1878 022 841	4313.30.00	430WGTZ
1878 022 841	4343.30.00	430GTZ
1878 023 731	4346.30.00	430WGTZ
1878 023 831	3961.30.00	395GTZ
1878 023 931	3960.30.00	395GTZ
1878 026 241	4312.30.00	430W2GTZ
1878 026 431	3163.30.00	310GTD
1878 027 231	4210.30.00	420/210GSZ
1878 027 442	4342.30.00	430GTZ
1878 031 002	4356.30.00	430WGTZ
1878 031 032	4356.30.00	430WGTZ
1878 031 048	4356.30.00	430WGTZ
1878 032 032	4007.30.00	400WGTZ
1878 032 133	4033.30.00	400WGTZ
1878 032 233	4031.30.00	400GTZ
1878 032 331	4380.30.00	430WGTZ
1878 037 001	4291.30.00	420GSZ
1878 037 631	4333.30.00	430WGTZ
1878 037 831	4356.30.00	430WGTZ
1878 037 834	4346.30.00	430WGTZ
1878 037 838	4346.30.00	430WGTZ
1878 037 844	43460.30.00	430WGTZ
1878 037 854	4356.30.00	430WGTZ
1878 037 857	43460.30.00	430WGTZ
1878 038 041	4386.30.00	430WGTZ
1878 039 631	3962.30.00	395GTZ
1878 039 731	3113.30.00	310GSBL
1878 040 631	4334.30.00	430GTZ
1878 043 231	4051.30.00	400WGVZ
1878 044 631	3610.30.00	362GTZ
1878 045 541	2172.30.00	215D
1878 046 631	3951.30.00	395WGTZ
1878 052 842	3626.30.00	362 WGTZ
1878 052 842	3627.30.00	362WGTB
1878 054 031	4331.30.00	430WGTZ
1878 054 933	4334.30.00	430GTZ
1878 054 951	4327.30.00	430GTZ
1878 054 953	4346.30.00	430WGTZ
1878 056 331	4025.30.00	400WGTZ
1878 056 732	4393.30.00	430WGTZ
1878 061 841	4314.30.00	430WGTZ
1878 062 944	4302.30.00	430GTZ
1878 063 231	4333.30.00	430WGTZ
1878 063 501	3575.30.00	350WGSZ
1878 063 531	3607.30.00	362WGTZ
1878 065 131	4304.30.00	430WGTZ
1878 074 641	2822.30.00	280GTZ
1878 074 741	2518.30.00	250GSZ
1878 074 841	2858.30.00	280GTZ
1878 076 031	3563.30.00	350GSZ
1878 077 041	3132.30.00	310GSB
1878 079 306	3608.30.00	362WGTZ
1878 079 331	3607.30.00	362WGTZ
1878 080 031	4316.30.00	430WGTZ
1878 080 031	4356.30.00	430WGTZ

Comparison refer.	RUEN reference	Parameter
1878 080 033	4306.30.00	430WGTZ
1878 080 034	4346.30.00	430WGTZ
1878 080 034	43460.30.00	430WGTZ
1878 080 035	4305.30.00	430W2GTZ
1878 080 035	4313.30.00	430WGTZ
1878 080 035	4346.30.00	430WGTZ
1878 080 037	4346.30.00	430WGTZ
1878 085 641	4300.30.00	430GTZ
1878 085 741	4326.30.00	430WGTZ
1878 085 742	4366.30.00	430WGTZ
1878 086 741	4287.30.00	420GVZ
1878 086 741	4304.30.00	430WGTZ
1878 086 742	4259.30.00	420GSZ
1878 086 941	4286.30.00	420WGTZ
1878 237 831	4316.30.00	430WGTZ
1878 600 501	2548.30.00	250CD
1878 634 008	2178.30.00	215CE
1878 634 009	2178.30.00	215CE
1878 634 017	4236.30.00	420/210GSZ
1878 634 024	4318.30.00	430WGTZ
1878 634 024	4350.30.00	430WGTZ
1878 634 025	4286.30.00	420WGTZ
1878 634 026	4331.30.00	430WGTZ
1878 634 027	4305.30.00	430W2GTZ
1878 634 034	3973.30.00	395WGTZ
1878 634 052	2306.30.00	228GSB
1878 634 082	2528.30.00	250BHZX
1878 997 101	2678.30.00	265VTP
1880 006 001	3540.20.00	LA350
1880 006 038	3540.20.00	LA350
1880 019 445	3515.10.00	GF2/350
1880 071 001	2260.20.00	KS225
1880 071 008	2262.20.00	KS225
1880 071 011	2260.20.00	KS225
1880 083 102	2802.20.00	G280
1880 083 132	2802.20.00	G280
1880 092 402	3130.20.00	G310K
1880 092 405	3131.20.00	G310
1880 092 415	3133.20.00	G310
1880 092 432	3130.20.00	G310K
1880 092 432	3133.20.00	G310
1880 092 435	3131.20.00	G310
1880 096 208	2841.20.00	G280
1881 009 201	2517.20.00	G250K
1881 009 203	2520.20.00	G250
1881 010 101	2521.20.00	G250
1881 010 139	2518.20.00	G250
1881 039 003	3505.20.00	G350KR
1881 039 309	3502.20.00	G350KR
1881 039 531	3506.20.00	G350
1881 039 532	3505.20.00	G350KR
1881 039 539	3505.20.00	G350KR
1881 041 526	3807.20.00	G380KR
1881 041 556	3807.20.00	G380KR
1881 041 656	3807.20.00	G380KR
1881 089 002	2262.20.00	KS225
1881 089 007	2262.20.00	KS225
1881 089 009	2262.20.00	KS225
1882 039 532	3505.20.00	G350KR
1882 110 202	3521.20.00	GF350KR
1882 110 402	3520.20.00	GF350KR
1882 110 513	3529.20.00	GF350KR
1882 110 532	3521.20.00	GF350KR
1882 110 540	3524.20.00	GF350KR
1882 110 542	3521.20.00	GF350KR
1882 110 542	3524.20.00	GF350KR

Comparison list by manufacturer

Comparison refer.	RUEN reference	Parameter
SACHS >>		
1882 137 206	3102.20.00	GF310K
1882 137 307	3107.20.00	GF310K
1882 150 004	2262.20.00	KS225
1882 150 031	2262.20.00	KS225
1882 166 707	3822.20.00	GF380KR
1882 166 737	3822.20.00	GF380KR
1882 201 102	2953.20.00	GF295
1882 201 103	2955.20.00	GF295
1882 201 132	2953.20.00	GF295
1882 201 133	2955.20.00	GF295
1882 205 234	2507.20.00	HBX250
1882 209 334	3563.20.00	GMF350
1882 209 335	3539.20.00	GF350
1882 226 402	4203.20.00	G420KR
1882 226 433	4211.20.00	G420KR
1882 226 533	4203.20.00	G420KR
1882 229 131	2808.20.00	G280
1882 230 232	2812.20.00	HVB280
1882 230 238	2812.20.00	HVB280
1882 231 131	2530.20.00	G250
1882 234 403	3522.20.00	GF350KR
1882 234 433	3522.20.00	GF350KR
1882 250 141	3516.20.00	G350KR
1882 250 142	3511.20.00	G350KR
1882 250 143	3515.20.00	GF2/350
1882 252 301	3120.20.00	GFX310
1882 252 303	3122.20.00	GFX310
1882 252 331	3120.20.00	GFX310
1882 252 333	3122.20.00	GFX310
1882 269 131	3126.20.00	GF310X
1882 280 110	3849.20.00	G380KR
1882 280 112	3856.20.00	G380KR
1882 280 140	3849.20.00	G380KR
1882 280 213	3892.20.00	GF2/380
1882 282 331	3125.20.00	GFX310
1882 286 231	3803.20.00	G380KR
1882 301 208	4234.20.00	GF420KR
1882 301 209	4235.20.00	GF420KR
1882 301 237	4222.20.00	GF420KR
1882 301 238	4234.20.00	GF420KR
1882 301 239	4224.20.00	GF420KR
1882 301 239	4235.20.00	GF420KR
1882 301 240	4296.20.00	GF420
1882 302 101	3821.20.00	GF380KR
1882 302 102	3827.20.00	GF380KR
1882 302 105	3831.20.00	GF380KR
1882 302 131	3821.20.00	GF380KR
1882 302 131	3835.20.00	GF380
1882 302 134	3835.20.00	GF380
1882 303 102	4250.20.00	GFX420KR
1882 303 103	4248.20.00	GFX420KR
1882 305 101	3101.20.00	GFX310
1882 305 102	3119.20.00	GFX310
1882 305 131	3101.20.00	GFX310
1882 305 132	3119.20.00	GFX310
1882 307 131	3536.20.00	GF350K
1882 308 102	4201.20.00	G420KR
1882 308 103	4205.20.00	G420KR
1882 308 133	4205.20.00	G420KR
1882 316 005	4237.20.00	GF420KR
1882 316 033	4226.20.00	GF420KR
1882 316 038	4298.20.00	GF420
1882 317 101	2845.20.00	HVB280
1882 317 131	2845.20.00	HVB280

Comparison refer.	RUEN reference	Parameter
1882 325 001	3801.20.00	G380KR
1882 325 032	3810.20.00	G380KR
1882 325 033	3802.20.00	G380KR
1882 325 034	3804.20.00	G380KR
1882 325 035	3814.20.00	G380KR
1882 325 039	3895.20.00	G380KR
1882 325 040	3801.20.00	G380KR
1882 325 134	3804.20.00	G380KR
1882 325 134	3814.20.00	G380KR
1882 325 139	3895.20.00	G380KR
1882 326 001	4236.20.00	GF420KR
1882 326 331	4236.20.00	GF420KR
1882 327 001	3829.20.00	GF380KR
1882 330 002	4222.20.00	GF420KR
1882 330 031	4224.20.00	GF420KR
1882 330 032	4222.20.00	GF420KR
1882 330 033	4225.20.00	GF420KR
1882 331 033	3821.20.00	GF380KR
1882 331 033	3835.20.00	GF380
1882 335 233	4277.20.00	GFX420KR
1882 335 234	4278.20.00	GFX420KR
1882 335 236	4277.20.00	GFX420KR
1882 337 031	4299.20.00	GFX420K
1882 341 001	3857.20.00	G380KR
1882 342 133	4253.20.00	GFX420KR
1882 342 134	4244.20.00	GFX420KR
1882 342 134	4253.20.00	GFX420KR
1882 349 001	3882.20.00	GF2/380
1882 349 002	3882.20.00	GF2/380
1882 349 003	3882.20.00	GF2/380
1882 600 122	2507.20.00	HBX250
1882 806 001	2809.20.00	H280
1882 814 001	2514.20.00	H250K
1882 815 001	2810.20.00	H280K
1888 015 346	3856.10.00	GF2/380
1888 015 515	3890.10.00	GF2/380
1888 015 523	3889.10.00	GF2/380
1888 015 524	3889.10.00	GF2/380
1888 015 542	3890.10.00	GF2/380
1888 019 344	3511.10.00	GF2/350
1888 019 445	3515.10.00	GF2/350
1888 019 539	3516.10.00	GF2/350
1888 019 542	3515.10.00	GF2/350
1888 042 009	3857.10.00	GF2/380
1888 055 005	3882.10.00	GF2/380
1888 055 035	3882.10.00	GF2/380
1888 055 041	3882.10.00	GF2/380
1888 055 131	3887.10.00	GF2/380
1888 055 247	3887.10.00	GF2/380
1888 280 110	3849.20.00	G380KR
1891 986 135	4255.30.00	420GS
1897 376 558	8526.40.00	KZI-4
1898 105 635	4342.30.00	430GTZ
1898 180 395	4343.30.00	430GTZ
1898 917 153	4343.30.00	430GTZ
1898 917 329	3591.30.00	350WGTZ
1898 917 329	3596.30.00	350WGSZ
3000 049 005	2150.90.26	
3000 120 001	2150.90.10	
3000 143 002	2150.90.03	
3000 154 001	2000.90.19	
3000 169 002	2000.90.36	
3000 169 004	2000.90.40	
3000 290 001	2150.90.18	
3000 297 002	2280.90.03	
3000 322 001	1800.90.02	

Comparison list by manufacturer

Comparison refer.	RUEN reference	Parameter
SACHS >>		
3000 324 001	1800.90.02	
3000 325 001	1800.90.02	
3000 389 004	2400.90.06	
3000 434 001	2400.90.01	
3000 441 002	2150.90.07	
3000 463 001	2150.90.16	
3000 569 001	2150.90.42	
3000 826 901	2400.90.05	
3000 830 001	2350.90.01	
3000 830 201	2280.90.02	
3000 830 301	2280.90.04	
3000 830 401	2150.90.26	
3000 951 249	2350.90.01	
3082 007 333	2400.20.00	MF240
3082 038 031	2171.20.00	MF215K
3082 054 132	2283.20.00	M228KR
3082 078 032	2173.20.00	M215
3082 092 231	2173.20.00	M215
3082 094 231	2400.20.00	MF240
3082 119 131	2185.20.00	CP215
3082 121 031	2282.20.00	M228KR
3082 121 031	2283.20.00	M228KR
3082 122 132	2403.20.00	MF240
3082 131 031	2171.20.00	MF215K
3082 133 041	2042.20.00	CP20
3082 156 031	2283.20.00	M228KR
3082 164 031	2173.20.00	M215
3082 196 131	2403.20.00	MF240
3082 859 101	2023.20.00	DB200
3082 859 141	2023.20.00	DB200
3082 859 143	2023.20.00	DB200
3082 879 042	2171.20.00	MF215K
3082 899 001	2185.20.00	CP215
3082 966 001	1801.20.00	T180120
3082 967 001	1801.20.00	T180120
3083 039 031	2353.20.00	MFZ235
3100 000 003	8922.40.00	KZISZ-5
3100 002 255	8918.40.00	KZISZ - 5
3100 008 001	8923.46.00	KZIZ-5
3100 008 101	8923.46.00	KZIZ-5
3100 008 106	8936.46.00	KZISZ-5
3100 008 201	8923.46.00	KZIZ-5
3100 008 204	8938.46.00	
3100 026 431	8929.46.00	KZIZ-5
3100 026 433	8946.46.00	KZIZ-5
3151 000 034	8916.40.00	KZIZ - 5
3151 000 144	8919.40.00	KZISZ - 5
3151 000 148	8924.40.00	KZIZ5
3151 000 151	8934.40.00	KZISZ - 5
3151 000 155	8918.40.00	KZISZ - 5
3151 000 157	8935.40.00	KZISZ - 5
3151 000 163	8925.40.00	KZISZ-5
3151 000 206	3214.40.00	KZI/T - 1
3151 000 217	8931.40.00	KZISZ-5
3151 000 272	8923.40.00	KZIZ - 5
3151 000 273	8948.40.00	KZIZ-5
3151 000 285	8526.40.00	KZI-4
3151 000 374	8529.40.00	KZI - 4,5
3151 000 375	8500.40.00	KZI - 4,5
3151 000 395	7951.40.00	KZIS - 4
3151 000 395	8505.40.00	KZI - 4,5
3151 000 396	8540.40.00	KZIS-4
3151 000 397	8541.40.00	KZIS-4
3151 000 404	8932.40.00	KZISZ - 5

Comparison refer.	RUEN reference	Parameter
3151 000 419	7451.40.00	KZIS-4
3151 000 493	8936.40.00	KZISZ - 5
3151 000 493	8939.40.00	KZISZ - 5
3151 000 512	8514.40.00	KZI - 4,5
3151 000 515	8514.40.00	KZI - 4,5
3151 000 752	8543.40.00	KZIS-4
3151 000 958	8533.40.00	KZI - 4,5
3151 001 035	8949.40.00	
3151 001 083	8947.40.00	KZISZ-5
3151 007 301	8514.40.00	KZI - 4,5
3151 007 303	8514.40.00	KZI - 4,5
3151 027 131	8500.40.00	KZI - 4,5
3151 033 031	6908.40.00	KZ - 3
3151 034 031	3214.40.00	KZI/T - 1
3151 043 031	8509.40.00	KZI - 4,5
3151 043 032	8503.40.00	KZI - 4,5
3151 044 031	6901.40.00	KZI - 3
3151 051 031	8302.40.00	KZI - 4
3151 054 032	8532.40.00	KZI - 4,5
3151 058 001	8514.40.00	KZI - 4,5
3151 065 031	4502.40.00	KZI - 1
3151 066 002	8505.40.00	KZI - 4,5
3151 066 032	8505.40.00	KZI - 4,5
3151 067 031	8533.40.00	KZI - 4,5
3151 067 032	8516.40.00	KZI - 4,5
3151 069 131	3203.40.00	KZIS - 1
3151 071 032	8510.40.00	KZI - 4,5
3151 087 041	8502.40.00	KZI - 4
3151 094 041	6915.40.00	KZI - 4
3151 095 043	6909.40.00	KZI - 3
3151 105 041	8900.40.00	KZI - 5
3151 105 141	8900.40.00	KZI - 5
3151 106 041	8901.40.00	KZI - 5
3151 108 031	8520.40.00	KZI - 4,5
3151 110 031	8513.40.00	KZI - 4,5
3151 112 031	8529.40.00	KZI - 4,5
3151 114 031	8510.40.00	KZI - 4,5
3151 116 031	6907.40.00	KZI - 3
3151 123 031	8930.40.00	KZI/Z-5
3151 126 031	8511.40.00	KZI - 4,5
3151 127 031	8512.40.00	KZI - 4,5
3151 130 141	3903.40.00	KZIS-0
3151 130 241	3903.40.00	KZIS-0
3151 133 331	3214.40.00	KZI/T - 1
3151 152 102	7951.40.00	KZIS - 4
3151 157 001	8505.40.00	KZI - 4,5
3151 166 031	9302.40.00	KZI-6
3151 169 131	8916.40.00	KZIZ - 5
3151 169 332	8916.40.00	KZIZ - 5
3151 170 131	5700.40.00	KZIZ - 3
3151 182 233	9101.40.00	KZI - 5
3151 195 032	8935.40.00	KZISZ - 5
3151 195 033	8935.40.00	KZISZ - 5
3151 199 001	6905.40.00	KZIS - 3
3151 203 031	8919.40.00	KZISZ - 5
3151 213 031	4500.40.00	KZIZ - 3
3151 220 031	5501.40.00	KZISZ - 3
3151 225 001	8919.40.00	KZISZ - 5
3151 225 031	8919.40.00	KZISZ - 5
3151 228 101	8923.46.00	KZIZ-5
3151 228 201	8923.46.00	KZIZ-5
3151 234 132	8936.40.00	KZISZ - 5
3151 245 031	8928.40.00	KZIZ - 5
3151 245 032	8917.40.00	KZIZ - 5
3151 246 031	8905.40.00	KZIZ - 5
3151 250 231	8937.40.00	KZISZ-5

Comparison list by manufacturer

Comparison refer.	RUEN reference	Parameter
SACHS >>		
3151 250 332	8932.40.00	KZISZ - 5
3151 253 031	8535.40.00	KZIZ - 4,5
3151 259 001	8918.40.00	KZISZ - 5
3151 259 031	8918.40.00	KZISZ - 5
3151 261 031	8540.40.00	KZIS-4
3151 262 031	8941.40.00	KZISZ-5
3151 263 031	8995.40.00	KZIZ-6
3151 272 631	8529.40.00	KZI - 4,5
3151 273 431	8916.40.00	KZIZ - 5
3151 274 131	8933.40.00	KZISZ - 5
3151 275 601	3211.40.00	KZIS - 0
3151 278 941	8940.40.00	KZISZ-5
3151 600 529	4500.40.00	KZIZ - 3
3151 600 540	7903.40.00	KZI-4
3151 600 595	8544.40.00	
3151 803 001	3206.40.00	KZIS - 1
3151 824 002	5902.40.00	KZA - 4
3151 824 005	7802.40.00	KZA - 4
3151 843 001	3205.40.00	KZIS - 0
3151 846 001	3216.40.00	KZAS - 0
3151 847 001	3224.40.00	KZAS - 00
3151 859 001	3233.40.00	KZAS - 0B
3151 868 001	3212.40.00	KZI - 0
3151 999 116	6907.40.00	KZI - 3
3180 000 001	8918.40.00	KZISZ - 5
3182 005 031	8633.47.00	HHISZ-3
3182 005 131	8633.47.00	HHISZ-3
3182 005 231	8633.47.00	HHISZ-3
3182 006 131	8631.47.00	HHISZ-4
3182 006 231	8631.47.00	HHISZ-4
3182 006 531	8631.47.00	HHISZ-4
3182 008 032	8603.47.00	HHIS-3
3182 008 037	8603.47.00	HHIS-3
3182 008 037	8653.47.00	HHIS-3
3182 008 039	8603.47.00	HHIS-3
3182 009 936	8631.47.00	HHISZ-4
3182 009 938	8631.47.00	HHISZ-4
3182 600 101	8653.47.00	HHIS-3
3182 600 141	8601.47.00	
3182 600 166	8602.47.00	
3182 600 172	8604.47.00	
3182 998 501	8603.47.00	HHIS-3
3400 005 034	4300.90.37	
3400 005 035	4300.90.06	
3400 005 036	4300.90.36	
3400 035 032	4300.90.22	
3400 037 031	3800.90.10	
3400 037 032	3800.90.48	
3400 040 032	4300.90.76	
3400 043 032	4300.90.33	
3400 067 031	3100.90.03	
3400 068 031	3300.90.01	
3400 093 031	4000.90.19	
3400 106 031	4300.90.21	
3400 116 901	4300.90.47	
3400 117 201	4300.90.350	
3400 117 202	4300.90.48	
3400 117 301	3100.90.01	
3400 117 532	4000.90.07	
3400 117 701	2650.90.15	
3400 117 801	4300.90.04	
3400 117 802	4300.90.02	
3400 119 001	4200.90.49	
3400 121 001	4200.90.83	

Comparison refer.	RUEN reference	Parameter
3400 121 002	4200.90.02	
3400 121 101	4200.90.82	
3400 121 201	3950.90.01	
3400 121 301	3950.90.03	
3400 121 401	3620.90.01	
3400 121 501	4000.90.04	
3400 121 601	4000.90.03	
3400 121 701	3950.90.02	
3400 121 801	3620.90.10	
3400 121 901	4000.90.01	
3400 122 001	4300.90.09	
3400 122 101	4300.90.03	
3400 122 101	4300.90.14	
3400 122 201	4300.90.05	
3400 122 201	4300.90.051	
3400 122 301	4300.90.49	
3400 122 401	3100.90.12	
3400 122 501	4300.90.28	
3400 122 601	4300.90.01	
3400 122 701	4300.90.50	
3400 122 801	4300.90.15	
3400 122 901	4300.90.07	
3400 123 001	4300.90.18	
3400 123 101	4300.90.349	
3400 123 301	4300.90.46	
3400 123 401	4300.90.61	
3400 123 501	4000.90.61	
3400 123 601	4000.90.60	
3400 123 701	4300.90.11	
3400 123 801	4300.90.24	
3400 123 901	4300.90.10	
3400 124 001	4300.90.01	
3400 124 101	4300.90.30	
3400 124 301	3300.90.04	
3400 124 501	3100.90.02	
3400 124 601	4200.90.78	
3400 124 701	3800.90.52	
3400 124 801	3500.90.39	
3400 124 901	3500.90.05	
3400 125 001	3500.90.11	
3400 125 101	3500.90.11	
3400 125 201	2800.90.01	
3400 125 501	3500.90.04	
3400 125 701	4200.90.77	
3400 125 901	4200.90.84	
3400 127 101	4300.90.34	
3400 127 201	4300.90.21	
3400 127 301	2800.90.01	
3400 127 401	4300.90.20	
3400 127 401	4300.90.52	
3400 127 701	3620.90.02	
3400 700 303	3620.90.09	
3400 700 305	4200.90.22	
3400 700 307	3620.90.03	
3400 700 308	3950.90.07	
3400 700 311	4000.90.12	
3400 700 313	4300.90.177	
3400 700 315	4000.90.17	
3400 700 316	3950.90.08	
3400 700 319	4200.90.81	
3400 700 320	3950.90.09	
3400 700 322	3300.90.08	
3400 700 324	4300.90.114	
3400 700 329	4300.90.75	
3400 700 330	4300.90.54	
3400 700 331	4300.90.38	

Comparison list by manufacturer

Comparison refer.	RUEN reference	Parameter
SACHS >>		
3400 700 332	4300.90.17	
3400 700 333	4300.90.55	
3400 700 334	4300.90.39	
3400 700 335	4300.90.74	
3400 700 337	3950.90.12	
3400 700 338	3500.90.43	
3400 700 339	3500.90.42	
3400 700 340	4000.90.13	
3400 700 342	4300.90.16	
3400 700 343	4300.90.35	
3400 700 344	4300.90.65	
3400 700 345	4300.90.44	
3400 700 347	3100.90.13	
3400 700 350	4300.90.62	
3400 700 351	4300.90.63	
3400 700 352	4300.90.113	
3400 700 353	3620.90.05	
3400 700 354	4300.90.51	
3400 700 357	4300.90.128	
3400 700 357	4300.90.64	
3400 700 360	4000.90.28	
3400 700 361	4300.90.171	
3400 700 361	4300.90.72	
3400 700 364	3950.90.15	
3400 700 365	4300.90.68	
3400 700 366	4300.90.109	
3400 700 368	4300.90.69	
3400 700 370	4300.90.212	
3400 700 372	4300.90.111	
3400 700 373	4300.90.213	
3400 700 374	4300.90.222	
3400 700 375	3620.90.07	
3400 700 376	3950.90.06	
3400 700 378	4300.90.94	
3400 700 380	4300.90.52	
3400 700 381	4300.90.56	
3400 700 382	4300.90.119	
3400 700 395	4300.90.175	
3400 700 396	3950.90.25	
3400 700 397	3950.90.21	
3400 700 399	4300.90.91	
3400 700 401	4300.90.23	
3400 700 402	4300.90.101	
3400 700 402	4300.90.53	
3400 700 403	4300.90.13	
3400 700 404	4300.90.103	
3400 700 404	4300.90.12	
3400 700 405	3620.90.08	
3400 700 406	4000.90.10	
3400 700 407	4000.90.15	
3400 700 408	4300.90.40	
3400 700 409	4300.90.60	
3400 700 410	4300.90.41	
3400 700 411	4300.90.29	
3400 700 412	3800.90.14	
3400 700 413	4300.90.15	
3400 700 414	4300.90.78	
3400 700 415	4300.90.381	
3400 700 417	3500.90.13	
3400 700 418	4300.90.42	
3400 700 422	4000.90.08	
3400 700 423	4000.90.09	
3400 700 428	3620.90.06	
3400 700 429	2650.90.01	

Comparison refer.	RUEN reference	Parameter
3400 700 432	2800.90.31	
3400 700 433	2350.90.01	
3400 700 435	4300.90.176	
3400 700 436	3620.90.51	
3400 700 439	3620.90.29	
3400 700 444	2650.90.15	
3400 700 445	4300.90.104	
3400 700 447	2650.90.15	
3400 700 449	3100.90.03	
3400 700 450	4300.90.56	
3400 700 455	4300.90.02	
3400 700 459	4300.90.105	
3400 700 460	4300.90.102	
3400 700 462	4300.90.178	
3400 700 466	3950.90.20	395
3400 700 467	4300.90.89	
3400 700 468	4300.90.382	
3400 700 469	4300.90.179	
3400 700 470	4300.90.117	
3400 700 478	4300.90.118	
3400 700 482	3620.90.28	
3400 700 483	2800.90.32	
3400 700 487	3620.90.52	
3400 700 489	4300.90.97	
3400 700 491	4300.90.232	
3400 700 494	4300.90.202	
3400 700 495	4300.90.98	
3400 700 504	4300.90.181	
3400 700 521	4300.90.188	
3400 700 522	4300.90.189	
3400 700 600	4300.90.129	
3400 700 603	3500.90.53	
3400 700 604	4300.90.334	
3400 700 607	3620.90.50	
3400 700 609	4000.90.18	MFZ2/400X
3400 700 619	4300.90.214	
3400 700 625	3950.90.32	
3400 700 626	3620.90.28	
3400 700 628	3950.90.24	
3400 700 629	4000.90.29	
3400 700 631	3950.90.32	
3400 710 001	3620.90.30	
3400 710 002	3620.90.11	
3400 710 005	3620.90.32	
3400 710 006	3950.90.31	
3400 710 007	3950.90.33	
3400 710 009	3950.90.34	
3400 710 010	3950.90.38	
3400 710 012	3950.90.36	
3400 710 013	3950.90.39	
3400 710 014	3950.90.40	
3400 710 015	3950.90.37	
3400 710 016	3950.90.35	
3400 710 017	3950.90.42	
3459 018 004	4026.50.00	MFZ2/400X
3482 000 042	43100.20.00	MFZ430E
3482 000 151	4313.20.00	MFZ430
3482 000 195	4339.20.00	MFZ430
3482 000 196	4319.20.00	MFZ430
3482 000 197	3952.20.00	MF395
3482 000 246	4339.20.00	MFZ430
3482 000 251	4313.20.00	MFZ430
3482 000 257	4393.20.00	MFZ430
3482 000 270	3863.20.00	GM380
3482 000 361	4319.20.00	MFZ430
3482 000 419	3607.20.00	MF362

Comparison list by manufacturer

Comparison refer.	RUEN reference	Parameter
SACHS >>		
3482 000 461	3601.20.00	MF362
3482 000 461	3608.20.00	MF362
3482 000 462	3606.20.00	MF362
3482 000 463	3951.20.00	MF395
3482 000 464	3952.20.00	MF395
3482 000 467	3956.20.00	MFZ395
3482 000 474	3953.20.00	MF395
3482 000 484	4371.20.00	MFZ430
3482 000 556	4382.60.00	MFZ430
3482 000 556	4394.20.00	MFZ430
3482 000 573	4303.20.00	MFZ430
3482 000 679	3972.20.00	MF395
3482 000 691	4390.20.00	MFZ430
3482 000 819	4387.20.00	MFZ430
3482 000 852	4307.20.00	MFZ430
3482 000 953	3580.20.00	GMF350
3482 000 999	4394.20.00	MFZ430
3482 001 071	3620.20.00	MF362
3482 001 101	4261.20.00	GMF420K
3482 001 104	4263.20.00	GMF420K
3482 001 107	4268.20.00	GMF420K
3482 001 134	4263.20.00	GMF420K
3482 001 136	4269.20.00	GMF420K
3482 001 137	4268.20.00	GMF420K
3482 001 139	4261.20.00	GMF420K
3482 001 166	35173.20.00	MF350
3482 001 184	43104.20.00	MFZ430
3482 001 234	4263.20.00	GMF420K
3482 002 102	3563.20.00	GMF350
3482 002 103	3562.20.00	GMF350
3482 002 104	3563.20.00	GMF350
3482 002 106	3566.20.00	GMF350
3482 002 107	3565.20.00	GMF350
3482 002 132	3563.20.00	GMF350
3482 002 135	3563.20.00	GMF350
3482 002 137	3563.20.00	GMF350
3482 002 202	3563.20.00	GMF350
3482 002 203	3562.20.00	GMF350
3482 002 204	3563.20.00	GMF350
3482 002 204	3565.20.00	GMF350
3482 002 232	3563.20.00	GMF350
3482 002 233	3562.20.00	GMF350
3482 002 234	3563.20.00	GMF350
3482 002 235	3563.20.00	GMF350
3482 002 237	3563.20.00	GMF350
3482 002 237	3565.20.00	GMF350
3482 008 003	3162.20.00	MF310
3482 008 006	3166.20.00	MF310
3482 008 008	3164.20.00	MF310
3482 008 009	3168.20.00	MF310
3482 008 032	3161.20.00	MF310
3482 008 033	3162.20.00	MF310
3482 008 033	3169.20.00	MF310
3482 008 034	3160.20.00	MF310
3482 008 038	3164.20.00	MF310
3482 008 039	3168.20.00	MF310
3482 008 110	3168.20.00	MF310
3482 008 244	3158.20.00	MF310
3482 011 201	3580.20.00	GMF350
3482 011 202	3581.20.00	GMF350KR
3482 011 331	3580.20.00	GMF350
3482 011 332	3581.20.00	GMF350KR
3482 012 201	3300.20.00	GFM330
3482 012 211	3300.20.00	GFM330

Comparison refer.	RUEN reference	Parameter
3482 012 231	3300.20.00	GFM330
3482 012 237	3300.20.00	GFM330
3482 012 240	3305.20.00	GMF330
3482 017 033	3877.20.00	GMF380
3482 017 034	3878.20.00	GMF380
3482 017 035	3879.20.00	GMF380
3482 018 101	4257.20.00	GMF420K
3482 018 132	4256.20.00	GMF420K
3482 018 202	4256.20.00	GMF420K
3482 018 205	4256.20.00	GMF420K
3482 018 231	4257.20.00	GMF420K
3482 021 001	3860.20.00	GM380K
3482 021 002	3861.20.00	GM380
3482 021 031	3860.20.00	GM380K
3482 022 001	2820.20.00	MF280
3482 032 201	2835.20.00	MFZ280
3482 032 231	2835.20.00	MFZ280
3482 036 001	3180.20.00	GMFZ310KR
3482 036 301	3180.20.00	GMFZ310KR
3482 036 331	3180.20.00	GMFZ310KR
3482 036 331	3184.20.00	MFZ310
3482 037 041	3866.20.00	GM380K
3482 037 141	3866.20.00	GM380K
3482 038 001	3570.20.00	GMF350
3482 046 031	2823.20.00	MF280
3482 048 041	2822.20.00	MF280
3482 049 041	3173.20.00	MF310
3482 051 032	3583.20.00	GMF350
3482 051 131	3580.20.00	GMF350
3482 051 201	3580.20.00	GMF350
3482 054 031	2837.20.00	MFZ280
3482 054 131	2837.20.00	MFZ280
3482 055 102	3176.20.00	MFZ310
3482 055 132	3176.20.00	MFZ310
3482 060 131	3573.20.00	MF350
3482 060 132	3573.20.00	MF350
3482 060 233	3573.20.00	MF350
3482 060 235	3581.20.00	GMF350KR
3482 081 231	4304.20.00	MFZ430
3482 081 232	4305.20.00	MFZ430
3482 081 233	4300.20.00	MFZ430
3482 081 233	4307.20.00	MFZ430
3482 083 031	4300.20.00	MFZ430
3482 083 032	4301.20.00	MFZ430
3482 083 032	4303.20.00	MFZ430
3482 083 034	4311.20.00	MFZ430
3482 083 034	4313.20.00	MFZ430
3482 083 039	4313.20.00	MFZ430
3482 083 039	4313.26.00	MFZ430
3482 083 041	4303.20.00	MFZ430
3482 083 113	4300.20.00	MFZ430
3482 083 118	4304.20.00	MFZ430
3482 083 119	4301.20.00	MFZ430
3482 083 145	4308.20.00	MFZ430
3482 083 150	4328.20.00	MFZ430
3482 085 033	4236.20.00	GF420KR
3482 093 031	3312.20.00	MFZ330
3482 093 032	3313.20.00	MFZ330
3482 094 031	3179.20.00	MFZ310
3482 102 031	3180.20.00	GMFZ310KR
3482 102 031	3184.20.00	MFZ310
3482 102 032	3184.20.00	MFZ310
3482 106 031	3566.20.00	GMF350
3482 106 133	3566.20.00	GMF350
3482 112 031	4060.26.00	MFZ400X
3482 115 031	3957.20.00	MFZ395

Comparison list by manufacturer

Comparison refer.	RUEN reference	Parameter
SACHS >>		
3482 115 032	3956.20.00	MFZ395
3482 118 031	4248.20.00	GFX420KR
3482 119 031	4256.20.00	GMF420K
3482 119 032	4257.20.00	GMF420K
3482 119 034	4263.20.00	GMF420K
3482 120 031	3610.20.00	MFZ362
3482 123 234	4304.26.00	MFZ430
3482 123 235	4304.26.00	MFZ430
3482 123 243	4311.26.00	MFZ430
3482 123 441	4311.26.00	MFZ430
3482 123 534	4339.20.00	MFZ430
3482 123 833	3951.20.00	MF395
3482 123 839	3953.20.00	MF395
3482 124 041	3573.20.00	MF350
3482 124 041	3574.20.00	14" MF 350
3482 124 514	4261.20.00	GMF420K
3482 124 516	4253.20.00	GFX420KR
3482 124 522	4250.20.00	GFX420KR
3482 124 531	4237.20.00	GF420KR
3482 124 532	4298.20.00	GF420
3482 124 533	4299.20.00	GFX420K
3482 124 534	4224.20.00	GF420KR
3482 124 534	4225.20.00	GF420KR
3482 124 541	4226.20.00	GF420KR
3482 124 541	4234.20.00	GF420KR
3482 124 542	4269.20.00	GMF420K
3482 124 731	4378.20.00	MFZ430
3482 125 131	4278.20.00	GFX420KR
3482 125 512	3608.20.00	MF362
3482 126 331	3606.20.00	MF362
3482 634 003	3961.20.00	MF395
3482 634 004	4395.20.00	MFZ430
3482 906 001	3169.20.00	MF310
3482 907 001	2651.20.00	MF265
3482 911 001	2654.20.00	MF270
3482 998 701	2658.20.00	MFZ265
3482 999 027	2821.20.00	MF280K
3483 000 258	4340.60.00	MFZ430
3483 000 348	4382.60.00	MFZ430
3483 000 382	4384.60.00	MFZ430
3483 000 422	4349.60.00	MFZ430
3483 020 033	4330.60.00	MFZ430
3483 020 034	4310.60.00	MFZ430
3483 020 035	4334.60.00	MFZ430
3483 020 036	4331.60.00	MFZ430
3483 028 031	4060.60.00	MFZ400X
3483 030 031	4318.60.00	MFZ430
3483 030 032	4329.60.00	MFZ430
3483 034 032	4332.60.00	MFZ430
3483 034 033	4332.60.00	MFZ430
3483 034 034	4333.60.00	MFZ430
3483 034 042	4336.60.00	MFZ430
3483 034 043	4385.60.00	MFZ430
3483 034 135	4027.60.00	MFZ2/400X
3488 000 024	4047.10.00	MFZ2/400X
3488 000 065	4022.10.00	MFZ2/400X
3488 000 122	4026.10.00	MFZ2/400X
3488 000 158	4022.10.00	MFZ2/400X
3488 000 159	4027.10.00	MFZ2/400X
3488 000 366	4021.10.00	MFZ2/400X
3488 000 373	4047.10.00	MFZ2/400X
3488 017 333	4001.10.00	MFZ2/400X
3488 017 334	4036.10.00	MFZ2/400X
3488 017 432	4010.10.00	MFZ2/400X

Comparison refer.	RUEN reference	Parameter
3488 017 439	4026.10.00	MFZ2/400X
3488 017 442	4026.10.00	MFZ2/400X
3488 017 442	4029.10.00	MFZ2/400X
3488 017 447	4028.10.00	MFZ2/400X
3488 017 448	4025.10.00	MFZ2/400X
3488 022 253	4027.10.00	MFZ2/400X
3488 023 031	4025.10.00	MFZ2/400X
3488 023 032	4025.10.00	MFZ2/400X
3499 373 055	2525.20.00	MF250
355 175	3516.20.00	G350KR
6482 000 087	8641.47.00	PHIS-6/38
6482 000 155	8641.47.00	PHIS-6/38

VALEO		
003 398	2150.90.18	
003 462	2150.90.03	
006 757	2400.90.01	
079 800	2023.20.00	DB200
094 185	4263.20.00	GMF420K
094 492	2023.20.00	DB200
261 673	2514.20.00	H250K
263 105	2042.20.00	CP20
263 645	3866.20.00	GM380K
264 134	3173.20.00	MF310
264 169	3903.40.00	KZIS-0
264 630	3211.40.00	KZIS - 0
264 635	2171.20.00	MF215K
265 254	3903.40.00	KZIS-0
265 315	3216.40.00	KZAS - 0
266 121	3224.40.00	KZAS - 00
266 923	2185.20.00	CP215
266 938	2157.30.00	215PSD
267 426	2185.20.00	CP215
279 002	2822.20.00	MF280
279 014	3866.20.00	GM380K
279 103	2173.20.00	M215
279 118	2402.20.00	MF240
279 165	2023.20.00	DB200
279 375	2402.30.00	240PSD
279 379	2034.30.00	200CE
279 389	2403.20.00	MF240
279 421	2023.20.00	DB200
279 431	4502.40.00	KZI - 1
279 458	2042.20.00	CP20
279 675	3903.40.00	KZIS-0
279 726	2822.20.00	MF280
355 100	4211.20.00	G420KR
355 101	4254.30.00	420GSZ
355 102	4201.20.00	G420KR
355 104	3521.20.00	GF350KR
355 106	3522.20.00	GF350KR
355 108	3522.20.00	GF350KR
355 110	3520.20.00	GF350KR
355 111	3804.20.00	G380KR
355 119	4205.20.00	G420KR
355 125	2507.20.00	HBX250
355 128	3519.30.00	350GSZ
355 130	3822.30.00	380GSZ
355 131	2953.20.00	GF295
355 132	2954.30.00	295BHZ
355 138	4235.20.00	GF420KR
355 139	4231.30.00	420GSZ
355 140	3120.20.00	GFX310
355 141	4222.20.00	GF420KR
355 145	3801.20.00	G380KR
355 146	3822.20.00	GF380KR

Comparison list by manufacturer

Comparison refer.	RUEN reference	Parameter
VALEO >>		
355 149	4226.20.00	GF420KR
355 150	4248.20.00	GFX420KR
355 153	4244.30.00	420/210GSZ
355 155	3530.30.00	350GSZ
355 164	3510.30.00	350W2GSZ
355 165	3821.20.00	GF380KR
355 167	3827.20.00	GF380KR
355 176	3528.30.00	350GSZ
355 177	3527.30.00	350GSZ
355 178	4257.20.00	GMF420K
355 179	4212.30.00	420/210GSZ
355 338	3126.30.00	310GSBL
355 542	2157.30.00	215PSD
355 575	2172.30.00	215D
355 576	2172.30.00	215D
355 591	3203.40.00	KZIS - 1
355 591	3214.40.00	KZI/T - 1
355 592	2157.30.00	215PSD
357 810	3812.30.00	380GSZ
357 978	2812.20.00	HVB280
357 978	2823.20.00	MF280
358 192	3563.20.00	GMF350
358 200	2403.20.00	MF240
358 262	2282.20.00	M228KR
358 262	2283.20.00	M228KR
358 275	3206.40.00	KZIS - 1
358 279	2307.30.00	228CB
358 280	3565.20.00	GMF350
358 281	8509.40.00	KZI - 4,5
358 282	3562.20.00	GMF350
358 286	8500.40.00	KZI - 4,5
358 295	3300.20.00	GFM330
358 296	3300.30.00	330GSZ
358 297	6901.40.00	KZI - 3
358 320	2171.20.00	MF215K
358 323	8900.40.00	KZI - 5
358 331	3829.20.00	GF380KR
358 332	3878.20.00	GMF380
358 333	3852.30.00	380GS
358 335	4261.20.00	GMF420K
358 343	3561.30.00	350GSZ
358 350	4244.20.00	GFX420KR
358 511	8514.40.00	KZI - 4,5
358 546	6908.40.00	KZ - 3
358 547	6908.40.00	KZ - 3
358 810	3812.30.00	380GSZ
378 662	2198.30.00	215CE
472 020	2810.20.00	H280K
508 028	4304.20.00	MFZ430
582 472	3580.20.00	GMF350
582 597	3578.30.00	14" 350GSZ
583 314	3133.30.00	310GSBL
583 314 TUR.	3133.30.00	310GSBL
801 040	2150.90.10	
801 250	2150.90.07	
801 409	2350.90.01	
801 435	2280.90.02	
801 546	2280.90.03	
801 939	1800.90.02	
802 308	1801.20.00	T180120
802 321	2023.20.00	DB200
803 393	1801.30.00	180DE2R
804 007	3233.40.00	KZAS - 0B
804 019	3214.40.00	KZI/T - 1

Comparison refer.	RUEN reference	Parameter
804 022	3205.40.00	KZIS - 0
804 106	3212.40.00	KZI - 0
805 028	4300.90.01	
805 030	4300.90.04	
805 031	4300.90.02	
805 034	4300.90.07	
805 037	3300.90.01	
805 062	4300.90.05	
805 063	4300.90.04	
805 064	4300.90.02	
805 073	4300.90.11	
805 164	4300.90.03	
805 172	3516.10.00	GF2/350
805 175	3857.10.00	GF2/380
805 176	3882.10.00	GF2/380
805 186	4300.90.05	
805 220	4300.90.10	
805 228	4300.90.06	
805 386	4300.90.41	
805 450	4300.90.09	
805 453	4300.90.11	
805 454	4300.90.09	
805 507	2822.20.00	MF280
805 508	3574.20.00	14" MF 350
805 513	4305.20.00	MFZ430
805 518	3173.20.00	MF310
805 525	3164.20.00	MF310
805 531	2353.20.00	MFZ235
805 549	4222.20.00	GF420KR
805 549	4234.20.00	GF420KR
805 551	3831.20.00	GF380KR
805 564	3305.20.00	GMF330
805 566	3580.20.00	GMF350
805 570	3179.20.00	MFZ310
805 570 TUR.	3189.20.00	MFZ 310
805 589	3849.20.00	G380KR
805 600	4301.20.00	MFZ430
805 601	3882.20.00	GF2/380
805 602	2282.20.00	M228KR
805 603	4311.26.00	MFZ430
805 607	3162.20.00	MF310
805 612	3312.20.00	MFZ330
805 615	3877.20.00	GMF380
805 632	4313.20.00	MFZ430
805 633	4307.20.00	MFZ430
805 642	4300.20.00	MFZ430
805 643	3860.20.00	GM380K
805 645	3101.20.00	GFX310
805 646	3807.20.00	G380KR
805 648	3119.20.00	GFX310
805 649	4224.20.00	GF420KR
805 691	3122.20.00	GFX310
805 707	2802.20.00	G280
805 708	3857.20.00	G380KR
805 711	4304.20.00	MFZ430
805 722	3539.20.00	GF350
805 724	4301.20.00	MFZ430
805 726	4263.20.00	GMF420K
805 748	3804.20.00	G380KR
805 749	2517.20.00	G250K
805 750	2518.20.00	G250
805 752	3131.20.00	G310
805 754	2803.20.00	G280
805 771	4318.60.00	MFZ430
805 779	3606.20.00	MF362
805 781	4329.60.00	MFZ430

Comparison list by manufacturer

Comparison refer.	RUEN reference	Parameter
VALEO >>		
805 785	4311.20.00	MFZ430
805 786	4328.20.00	MFZ430
805 787	4328.20.00	MFZ430
805 798	4332.60.00	MFZ430
805 801	4332.60.00	MFZ430
805 809	4236.20.00	GF420KR
805 831	4305.20.00	MFZ430
805 842	3951.20.00	MF395
805 842	3962.20.00	15.5" MF 395
806 012	4258.30.00	420GSZ
806 013	3570.30.00	350Z
806 015	4305.30.00	430W2GTZ
806 018	3583.30.00	350GSZ
806 019	2528.30.00	250BHZX
806 021	3821.30.00	380GSZ
806 024	4311.30.00	430W2GTZ
806 092	2810.30.00	280CBL
806 113	2822.30.00	280GTZ
806 117	3136.30.00	310WGSZ
806 120	3882.30.00	380GSZ
806 128	3309.30.00	330GSZ
806 137	2504.30.00	250CBL
806 137	2514.30.00	250CBL
806 165	3839.30.00	380GSZ
806 166	3808.30.00	380GSZ
806 179	4272.30.00	420WGSZ
806 183	2306.30.00	228GSB
806 190	4305.30.00	430W2GTZ
806 196	3162.30.00	310GTD
806 198	3878.30.00	380/210GSZ
806 200	4327.30.00	430GTZ
806 203	3806.30.00	380W2GSZ
806 315	3892.30.00	380GSZ
806 363	4250.30.00	420WGSZ
806 393	2802.30.00	280BHZ
806 411	2517.30.00	250
806 432	3325.30.00	330WGSZ
806 441	4326.30.00	430WGTZ
806 443	4327.30.00	430GTZ
806 449	4306.30.00	430WGTZ
806 450	3517.30.00	350WGSZ
806 474	3896.30.00	380WGSZ
806 476	4203.30.00	420GS
806 478	4257.30.00	420GSZ
806 481	2832.30.00	280GTZ
806 504	6905.40.00	KZIS - 3
806 507	4500.40.00	KZIZ - 3
806 508	8919.40.00	KZISZ - 5
806 529	8520.40.00	KZI - 4,5
806 532	8511.40.00	KZI - 4,5
806 535	5501.40.00	KZISZ - 3
806 540	8901.40.00	KZI - 5
806 611	8905.40.00	KZIZ - 5
806 615	8505.40.00	KZI - 4,5
806 616	8916.40.00	KZIZ - 5
806 662	8401.40.00	KZI - 4,5
806 667	8932.40.00	KZISZ - 5
806 675	8937.40.00	KZISZ-5
806 677	8918.40.00	KZISZ - 5
806 683	8940.40.00	KZISZ-5
806 706	8933.40.00	KZISZ - 5
807 503	4334.30.00	430GTZ
807 507	4306.30.00	430WGTZ
807 508	4312.30.00	430W2GTZ

Comparison refer.	RUEN reference	Parameter
807 510	4318.30.00	430WGTZ
807 513	3626.30.00	362 WGTZ
807 515	4321.30.00	430 WGTZ
807 518	4261.30.00	420GSZ
807 537	4232.30.00	420GSZ
807 540	2528.30.00	250BHZX
807 542	4235.30.00	420/210GS
807 545	4333.30.00	430WGTZ
807 558	4326.30.00	430WGTZ
807 558	4327.30.00	430GTZ
807 571	4311.30.00	430W2GTZ
807 573	4312.30.00	430W2GTZ
807 575	4306.30.00	430WGTZ
807 722	3886.30.00	380GSZ
809 047	4000.90.07	
809 140	4300.90.15	
826 585	2400.90.05	
827 052	4300.90.51	
829 021	4027.30.00	400WGVZ
829 022	4028.30.00	400GTZ
829 025	4025.30.00	400WGTZ
829 026	4026.30.00	400GTZ
829 309	3132.30.00	310GSB
829 309 TUR.	3133.30.00	310GSBL
829 346	3574.30.00	14" 350GSZ
829 347	3592.30.00	14" 350GSZ
829 348	3574.30.00	14" 350GSZ
829 355	3965.30.00	15.5" 395GTZ
829 358	3961.30.00	395GTZ
829 365	3884.30.00	15" 380GSZ
829 366	3597.30.00	350 WGTZ
829 367	3133.30.00	310GSBL
829 367 TUR.	3133.30.00	310GSBL
830 001	8941.40.00	KZISZ-5
830 007	9101.40.00	KZI - 5
830 010	8934.40.00	KZISZ - 5
831 001	4026.10.00	MFZ2/400X
831 030	4313.20.00	MFZ430
831 317	3868.20.00	15" GM380
831 320	3574.20.00	14" MF 350
831 322	3574.20.00	14" MF 350
839 139	4300.90.15	

Comparison list by RUEN

RUEN reference	Parameter	Comparison refer.
----------------	-----------	-------------------

BORG&BEG

2171.20.00	MF215K	HE4521
2172.30.00	215D	HB4522
2353.20.00	MFZ235	HE5475
2514.20.00	H250K	HA 2526
2517.30.00	250	HB 3113
3179.20.00	MFZ310	HB 5495

LUK

2034.30.00	200CE	320 0178 10
2171.20.00	MF215K	122 0026 12
2172.30.00	215D	322 0148 10
2281.30.00	228PSD	323 0062 16
2307.30.00	228CB	323 0127 16
2507.20.00	HBX250	125 0002 20
2528.30.00	250BHZX	325 0002 26
2810.20.00	H280K	128 0011 50
2810.30.00	280CBL	328 0110 50
2837.20.00	MFZ280	128 0219 20
3101.20.00	GFX310	131 0030 20
3124.30.00	310GSBL	331 0001 26
3169.20.00	MF310	131 0223 50
3305.20.00	GMF330	133 0205 20
3519.30.00	350GSZ	335 0002 26
3580.20.00	GMF350	135 0201 20
3821.30.00	380GSZ	338 0003 26
3878.30.00	380/210GSZ	338 0139 20
3894.30.00	380GSZ	338 0125 26
3896.30.00	380WGSZ	338 0124 26
4235.20.00	GF420KR	142 0028 20
4258.30.00	420GSZ	342 0011 26
6901.40.00	KZI - 3	500 0173 20
6908.40.00	KZ - 3	500 0008 20

SACHS

1800.90.02		3000 322 001
1800.90.02		3000 324 001
1800.90.02		3000 325 001
1801.20.00	T180120	3082 966 001
1801.20.00	T180120	3082 967 001
1801.30.00	180DE2R	1862 768 001
2000.90.19		3000 154 001
2000.90.36		3000 169 002
2000.90.40		3000 169 004
2013.30.00	200S	1860 049 056
2023.20.00	DB200	3082 859 101
2023.20.00	DB200	3082 859 141
2023.20.00	DB200	3082 859 143
2034.30.00	200CE	1862 867 004
2042.20.00	CP20	3082 133 041
2045.30.00	200D	1861 869 042
2080.30.00	200VTB	1862 954 142
2150.90.03		3000 143 002
2150.90.07		3000 441 002
2150.90.10		3000 120 001
2150.90.16		3000 463 001
2150.90.18		3000 290 001
2150.90.26		3000 049 005
2150.90.26		3000 830 401
2150.90.42		3000 569 001
2157.30.00	215PSD	1861 543 535
2157.30.00	215PSD	1861 792 235
2157.30.00	215PSD	1862 757 001
2171.20.00	MF215K	3082 038 031

RUEN reference	Parameter	Comparison refer.
----------------	-----------	-------------------

2171.20.00	MF215K	3082 131 031
2171.20.00	MF215K	3082 879 042
2172.30.00	215D	1861 857 132
2172.30.00	215D	1878 045 541
2173.20.00	M215	3082 078 032
2173.20.00	M215	3082 092 231
2173.20.00	M215	3082 164 031
2178.30.00	215CE	1862 909 141
2178.30.00	215CE	1862 935 001
2178.30.00	215CE	1878 634 008
2178.30.00	215CE	1878 634 009
2185.20.00	CP215	1850 480 076
2185.20.00	CP215	3082 119 131
2185.20.00	CP215	3082 899 001
2198.30.00	215CE	1862 930 001
2198.30.00	215CE	1878 000 884
2256.30.00	225Z	1860 039 027
2260.20.00	KS225	1880 071 001
2260.20.00	KS225	1880 071 011
2260.30.00	225BHZ	1862 088 131
2262.20.00	KS225	1880 071 008
2262.20.00	KS225	1881 089 002
2262.20.00	KS225	1881 089 007
2262.20.00	KS225	1881 089 009
2262.20.00	KS225	1882 150 004
2262.20.00	KS225	1882 150 031
2280.90.02		3000 830 201
2280.90.03		3000 297 002
2280.90.04		3000 830 301
2281.30.00	228PSD	1861 515 332
2281.30.00	228PSD	1861 775 035
2281.30.00	228PSD	1861 856 132
2281.30.00	228PSD	1861 936 031
2281.30.00	228PSD	1861 936 042
2281.30.00	228PSD	1861 936 142
2281.30.00	228PSD	1862 936 142
2282.20.00	M228KR	3082 121 031
2283.20.00	M228KR	3082 054 132
2283.20.00	M228KR	3082 121 031
2283.20.00	M228KR	3082 156 031
2306.30.00	228GSB	1861 557 103
2306.30.00	228GSB	1861 557 233
2306.30.00	228GSB	1861 557 235
2306.30.00	228GSB	1861 557 236
2306.30.00	228GSB	1861 936 142
2306.30.00	228GSB	1878 634 052
2307.30.00	228CB	1861 557 237
2307.30.00	228CB	1861 620 233
2307.30.00	228CB	1861 620 234
2350.90.01		3000 830 001
2350.90.01		3000 951 249
2350.90.01		3400 700 433
2353.20.00	MFZ235	3083 039 031
2354.30.00	235CBL	1878 002 072
2400.20.00	MF240	3082 007 333
2400.20.00	MF240	3082 094 231
2400.30.00	240PSD	1861 433 401
2400.30.00	240PSD	1861 732 031
2400.90.01		3000 434 001
2400.90.05		3000 826 901
2400.90.06		3000 389 004
2402.20.00	MF240	1850 280 049
2402.20.00	MF240	1850 480 049
2402.30.00	240PSD	1850 481 008
2402.30.00	240PSD	1862 977 001
2403.20.00	MF240	3082 122 132

Comparison list by RUEN

RUEN reference	Parameter	Comparison refer.
SACHS >>		
2403.20.00	MF240	3082 196 131
2413.30.00	240TD	1862 347 131
2500.90.01		1800 125 201
2507.20.00	HBX250	1882 205 234
2507.20.00	HBX250	1882 600 122
2510.30.00	250Z	1864 202 035
2510.30.00	250Z	1864 246 437
2514.20.00	H250K	1850 280 784
2514.20.00	H250K	1882 814 001
2514.30.00	250CBL	1850 281 917
2514.30.00	250CBL	1862 967 002
2517.20.00	G250K	1881 009 201
2517.30.00	250	1860 056 124
2517.30.00	250	1864 202 035
2518.20.00	G250	1881 010 139
2518.30.00	250GSZ	1861 224 033
2518.30.00	250GSZ	1861 224 034
2518.30.00	250GSZ	1861 224 048
2518.30.00	250GSZ	1861 244 101
2518.30.00	250GSZ	1878 074 741
2520.20.00	G250	1881 009 203
2520.30.00	250CB	1862 353 041
2521.20.00	G250	1881 010 101
2525.20.00	MF250	3499 373 055
2528.30.00	250BHZX	1861 291 033
2528.30.00	250BHZX	1861 291 036
2528.30.00	250BHZX	1861 291 136
2528.30.00	250BHZX	1878 634 082
2530.20.00	G250	1882 231 131
2538.30.00	250TPZ	1861 840 133
2548.30.00	250CD	1878 600 501
2650.90.01		3400 700 429
2650.90.15		3400 117 701
2650.90.15		3400 700 444
2650.90.15		3400 700 447
2651.20.00	MF265	3482 907 001
2654.20.00	MF270	3482 911 001
2655.30.00	265TB	1862 967 001
2656.30.00	270CTB	1862 811 001
2658.20.00	MFZ265	3482 998 701
2678.30.00	265VTP	1878 997 101
2800.90.01		3400 125 201
2800.90.01		3400 127 301
2800.90.31		3400 700 432
2800.90.32		3400 700 483
2802.20.00	G280	1880 083 102
2802.20.00	G280	1880 083 132
2802.30.00	280BHZ	1861 060 003
2803.30.00	280BHZ	1861 060 003
2805.30.00	280BHZ	1861 611 031
2805.30.00	280BHZ	1861 611 131
2805.30.00	280BHZ	1862 039 015
2808.20.00	G280	1882 229 131
2809.20.00	H280	1882 806 001
2810.20.00	H280K	1850 280 683
2810.20.00	H280K	1882 815 001
2810.30.00	280CBL	1850 281 829
2810.30.00	280CBL	1862 722 001
2812.20.00	HVB280	1882 230 232
2812.20.00	HVB280	1882 230 238
2812.30.00	280Z	1860 062 037
2819.30.00	280GSZ	1861 296 033
2819.30.00	280GSZ	1861 296 034
2820.20.00	MF280	3482 022 001

RUEN reference	Parameter	Comparison refer.
2821.20.00	MF280K	3482 999 027
2821.30.00	280GTZ	1861 999 221
2822.20.00	MF280	3482 048 041
2822.30.00	280GTZ	1861 632 032
2822.30.00	280GTZ	1861 919 031
2822.30.00	280GTZ	1861 919 032
2822.30.00	280GTZ	1861 919 033
2822.30.00	280GTZ	1861 919 034
2822.30.00	280GTZ	1861 919 134
2822.30.00	280GTZ	1878 074 641
2823.20.00	MF280	3482 046 031
2827.30.00	280Z	1862 060 032
2832.30.00	280GTZ	1861 642 131
2832.30.00	280GTZ	1861 642 133
2832.30.00	280GTZ	1862 722 001
2835.20.00	MFZ280	3482 032 201
2835.20.00	MFZ280	3482 032 231
2837.20.00	MFZ280	3482 054 031
2837.20.00	MFZ280	3482 054 131
2841.20.00	G280	1880 096 208
2844.30.00	280Z	1864 040 017
2845.20.00	HVB280	1882 317 101
2845.20.00	HVB280	1882 317 131
2858.30.00	280GTZ	1862 307 031
2858.30.00	280GTZ	1862 307 032
2858.30.00	280GTZ	1862 307 132
2858.30.00	280GTZ	1862 449 031
2858.30.00	280GTZ	1878 074 841
2953.20.00	GF295	1882 201 102
2953.20.00	GF295	1882 201 132
2954.30.00	295BHZ	1861 279 031
2954.30.00	295BHZ	1861 279 133
2954.30.00	295BHZ	1861 279 135
2954.30.00	295BHZ	1864 279 033
2955.20.00	GF295	1882 201 103
2955.20.00	GF295	1882 201 133
3100.90.01		3400 117 301
3100.90.02		3400 124 501
3100.90.03		3400 067 031
3100.90.03		3400 700 449
3100.90.12		3400 122 401
3100.90.13		3400 700 347
3101.20.00	GFX310	1882 305 101
3101.20.00	GFX310	1882 305 131
3102.20.00	GF310K	1882 137 206
3102.30.00	310GSZ	1861 535 001
3107.20.00	GF310K	1882 137 307
3108.30.00	310GSZ	1861 600 033
3113.30.00	310GSBL	1861 577 037
3113.30.00	310GSBL	1861 577 136
3113.30.00	310GSBL	1878 039 731
3117.30.00	310GSZ	1861 384 231
3117.30.00	310GSZ	1861 384 334
3119.20.00	GFX310	1882 305 102
3119.20.00	GFX310	1882 305 132
3120.20.00	GFX310	1882 252 301
3120.20.00	GFX310	1882 252 331
3122.20.00	GFX310	1882 252 303
3122.20.00	GFX310	1882 252 333
3124.30.00	310GSBL	1861 303 232
3124.30.00	310GSBL	1861 303 246
3124.30.00	310GSBL	1861 303 248
3125.20.00	GFX310	1882 282 331
3126.20.00	GF310X	1882 269 131
3126.30.00	310GSBL	1861 303 243
3126.30.00	310GSBL	1861 303 248

Comparison list by RUEN

RUEN reference	Parameter	Comparison refer.
SACHS >>		
3130.20.00	G310K	1880 092 402
3130.20.00	G310K	1880 092 432
3130.30.00	310W2GSZ	1861 999 398
3131.20.00	G310	1880 092 405
3131.20.00	G310	1880 092 435
3132.30.00	310GSB	1878 000 611
3132.30.00	310GSB	1878 077 041
3133.20.00	G310	1880 092 415
3133.20.00	G310	1880 092 432
3136.30.00	310WGSZ	1861 964 034
3136.30.00	310WGSZ	1862 299 032
3140.30.00	310W2GSZ	1861 653 102
3155.30.00	310Z	1864 087 036
3158.20.00	MF310	3482 008 244
3160.20.00	MF310	3482 008 034
3161.20.00	MF310	3482 008 032
3162.20.00	MF310	3482 008 003
3162.20.00	MF310	3482 008 033
3162.30.00	310GTD	1861 577 037
3163.30.00	310GTD	1862 385 201
3163.30.00	310GTD	1878 026 431
3164.20.00	MF310	3482 008 008
3164.20.00	MF310	3482 008 038
3166.20.00	MF310	3482 008 006
3168.20.00	MF310	3482 008 009
3168.20.00	MF310	3482 008 039
3168.20.00	MF310	3482 008 110
3169.20.00	MF310	3482 008 033
3169.20.00	MF310	3482 906 001
3173.20.00	MF310	3482 049 041
3176.20.00	MFZ310	3482 055 102
3176.20.00	MFZ310	3482 055 132
3179.20.00	MFZ310	3482 094 031
3180.20.00	GMFZ310KR	3482 036 001
3180.20.00	GMFZ310KR	3482 036 301
3180.20.00	GMFZ310KR	3482 036 331
3180.20.00	GMFZ310KR	3482 102 031
3184.20.00	MFZ310	3482 036 332
3184.20.00	MFZ310	3482 036 331
3184.20.00	MFZ310	3482 102 031
3184.20.00	MFZ310	3482 102 032
3203.40.00	KZIS - 1	3151 069 131
3205.40.00	KZIS - 0	3151 843 001
3206.40.00	KZIS - 1	3151 803 001
3211.40.00	KZIS - 0	3151 275 601
3212.40.00	KZI - 0	3151 868 001
3214.40.00	KZI/T - 1	3151 000 206
3214.40.00	KZI/T - 1	3151 034 031
3214.40.00	KZI/T - 1	3151 133 331
3216.40.00	KZAS - 0	3151 846 001
3224.40.00	KZAS - 00	3151 847 001
3233.40.00	KZAS - 0B	3151 859 001
3300.20.00	GFM330	3482 012 201
3300.20.00	GFM330	3482 012 211
3300.20.00	GFM330	3482 012 231
3300.20.00	GFM330	3482 012 237
3300.30.00	330GSZ	1861 571 101
3300.30.00	330GSZ	1861 571 131
3300.30.00	330GSZ	1861 571 236
3300.90.01		3400 068 031
3300.90.04		3400 124 301
3300.90.08		3400 700 322
3305.20.00	GMF330	3482 012 240
3309.30.00	330GSZ	1862 438 031

RUEN reference	Parameter	Comparison refer.
3309.30.00	330GSZ	1862 438 032
3310.30.00	330GSZ	1861 667 034
3312.20.00	MFZ330	3482 093 031
3313.20.00	MFZ330	3482 093 032
3315.30.00	330GS	1862 310 132
3321.30.00	330GSB	1861 594 034
3325.30.00	330WGSZ	1861 963 033
3328.30.00	330WGSZ	1861 778 002
3328.30.00	330WGSZ	1861 778 003
3328.30.00	330WGSZ	1861 778 031
3328.30.00	330WGSZ	1861 874 031
3328.30.00	330WGSZ	1861 874 032
3500.90.04		3400 125 501
3500.90.05		3400 124 901
3500.90.11		3400 125 001
3500.90.11		3400 125 101
3500.90.13		3400 700 417
3500.90.39		3400 124 801
3500.90.42		3400 700 339
3500.90.43		3400 700 338
3500.90.51		1800 125 001
3500.90.53		3400 700 603
3502.20.00	G350KR	1881 039 309
3502.30.00	350GSZ	1861 274 003
3502.30.00	350GSZ	1861 274 004
3502.30.00	350GSZ	1861 274 233
3502.30.00	350GSZ	1878 001 074
3505.20.00	G350KR	1881 039 003
3505.20.00	G350KR	1881 039 532
3505.20.00	G350KR	1881 039 539
3505.20.00	G350KR	1882 039 532
3506.20.00	G350	1881 039 531
3510.30.00	350W2GSZ	1861 489 235
3510.30.00	350W2GSZ	1861 498 202
3510.30.00	350W2GSZ	1861 498 232
3510.30.00	350W2GSZ	1861 498 235
3510.30.00	350W2GSZ	1878 001 144
35101.30.00	350WGTZ	1878 007 172
3511.10.00	GF2/350	1888 019 344
3511.20.00	G350KR	1882 250 142
3512.30.00	350W2GSZ	1878 005 367
3512.30.00	350W2GSZ	1861 350 201
3512.30.00	350W2GSZ	1861 350 231
3512.30.00	350W2GSZ	1861 350 233
3512.30.00	350W2GSZ	1878 005 367
3514.30.00	350WGSZ	1861 438 203
3514.30.00	350WGSZ	1861 438 233
3514.30.00	350WGSZ	1861 438 235
3515.10.00	GF2/350	1880 019 445
3515.10.00	GF2/350	1888 019 445
3515.10.00	GF2/350	1888 019 542
3515.20.00	GF2/350	1882 250 143
3515.50.00	GF2-350	1859 170 204
3516.10.00	GF2/350	1888 019 539
3516.20.00	G350KR	1882 250 141
3516.20.00	G350KR	355 175
3516.30.00	350WGSZ	1861 438 204
3516.30.00	350WGSZ	1861 438 234
3516.30.00	350WGSZ	1878 005 367
3517.30.00	350WGSZ	1861 962 033
3517.30.00	350WGSZ	1878 001 144
35173.20.00	MF350	3482 001 166
3519.30.00	350GSZ	1861 288 105
3519.30.00	350GSZ	1861 288 135
3519.30.00	350GSZ	1861 288 136
3519.30.00	350GSZ	1878 001 074

Comparison list by RUEN

RUEN reference	Parameter	Comparison refer.
SACHS >>		
3520.20.00	GF350KR	1882 110 402
3521.20.00	GF350KR	1882 110 202
3521.20.00	GF350KR	1882 110 532
3521.20.00	GF350KR	1882 110 542
3522.20.00	GF350KR	1882 234 403
3522.20.00	GF350KR	1882 234 433
3522.30.00	350GSZ	1861 531 002
3524.20.00	GF350KR	1882 110 540
3524.20.00	GF350KR	1882 110 542
3527.30.00	350GSZ	1861 640 031
3527.30.00	350GSZ	1861 640 135
3527.30.00	350GSZ	1878 001 080
3528.30.00	350GSZ	1861 641 031
3528.30.00	350GSZ	1861 641 135
3529.20.00	GF350KR	1882 110 513
3530.30.00	350GSZ	1861 380 133
3530.30.00	350GSZ	1861 380 238
3530.30.00	350GSZ	1878 001 079
3531.30.00	350GSZ	1878 001 083
3536.20.00	GF350K	1882 307 131
3539.20.00	GF350	1882 209 335
3540.20.00	LA350	1880 006 001
3540.20.00	LA350	1880 006 038
3552.30.00	350	1861 034 003
3552.30.00	350	1861 034 047
3552.30.00	350	1861 034 147
3559.30.00	350GSZ	1861 437 002
3559.30.00	350GSZ	1878 001 083
3561.30.00	350GSZ	1861 437 034
3561.30.00	350GSZ	1861 437 104
3561.30.00	350GSZ	1861 437 337
3561.30.00	350GSZ	1878 001 082
3562.20.00	GMF350	3499 377 832
3562.20.00	GMF350	3482 002 103
3562.20.00	GMF350	3482 002 203
3562.20.00	GMF350	3482 002 233
3562.30.00	350GSZ	1861 437 106
3562.30.00	350GSZ	1861 437 236
3563.20.00	GMF350	1882 209 334
3563.20.00	GMF350	3482 002 102
3563.20.00	GMF350	3482 002 104
3563.20.00	GMF350	3482 002 132
3563.20.00	GMF350	3482 002 135
3563.20.00	GMF350	3482 002 137
3563.20.00	GMF350	3482 002 202
3563.20.00	GMF350	3482 002 204
3563.20.00	GMF350	3482 002 232
3563.20.00	GMF350	3482 002 234
3563.20.00	GMF350	3482 002 235
3563.20.00	GMF350	3482 002 237
3563.30.00	350GSZ	1861 325 105
3563.30.00	350GSZ	1861 325 135
3563.30.00	350GSZ	1861 325 142
3563.30.00	350GSZ	1861 777 037
3563.30.00	350GSZ	1861 777 041
3563.30.00	350GSZ	1878 001 071
3563.30.00	350GSZ	1878 076 031
3564.30.00	350GSZ	1861 325 106
3564.30.00	350GSZ	1861 325 141
3564.30.00	350GSZ	1861 777 043
3564.30.00	350GSZ	1878 001 070
3564.30.00	350GSZ	1878 001 078
3565.20.00	GMF350	3482 002 107
3565.20.00	GMF350	3482 002 204

RUEN reference	Parameter	Comparison refer.
3565.20.00	GMF350	3482 002 237
3566.20.00	GMF350	3482 002 106
3566.20.00	GMF350	3482 106 031
3566.20.00	GMF350	3482 106 133
3570.20.00	GMF350	3482 038 001
3570.30.00	350Z	1864 351 006
3571.30.00	350	1864 454 101
3571.30.00	350	1878 001 729
3573.20.00	MF350	3482 060 131
3573.20.00	MF350	3482 060 132
3573.20.00	MF350	3482 060 233
3573.20.00	MF350	3482 124 041
3574.20.00	14" MF 350	3482 124 001
3574.20.00	14" MF 350	3482 124 041
3575.30.00	350WGSZ	1861 714 133
3575.30.00	350WGSZ	1878 001 147
3575.30.00	350WGSZ	1878 063 501
3577.30.00	350WGSZ	1861 678 002
3580.20.00	GMF350	3482 000 953
3580.20.00	GMF350	3482 011 201
3580.20.00	GMF350	3482 011 331
3580.20.00	GMF350	3482 051 131
3580.20.00	GMF350	3482 051 201
3581.20.00	GMF350KR	3482 011 202
3581.20.00	GMF350KR	3482 011 332
3581.20.00	GMF350KR	3482 060 235
3583.20.00	GMF350	3482 051 032
3583.30.00	350GSZ	1861 787 004
3583.30.00	350GSZ	1861 787 031
3583.30.00	350GSZ	1861 787 034
3583.30.00	350GSZ	1878 001 070
3585.30.00	350GSZ	1861 742 032
3585.30.00	350GSZ	1861 866 032
3585.30.00	350GSZ	1878 001 077
3587.30.00	350GSZ	1862 236 031
3587.30.00	350GSZ	1878 001 077
3588.30.00	350GSZ	1861 234 001
3588.30.00	350GSZ	1861 234 010
3588.30.00	350GSZ	1878 001 074
3589.30.00	350GTZ	1861 380 238
3589.30.00	350GTZ	1861 695 031
3589.30.00	350GTZ	1861 695 032
3589.30.00	350GTZ	1861 958 231
3589.30.00	350GTZ	1878 001 079
3590.30.00	350GSZ	1861 957 231
3591.30.00	350WGTZ	1898 917 585
3591.30.00	350WGTZ	1862 491 031
3591.30.00	350WGTZ	1878 001 145
3591.30.00	350WGTZ	1898 917 329
3596.30.00	350WGSZ	1862 491 031
3596.30.00	350WGSZ	1878 000 841
3596.30.00	350WGSZ	1878 001 145
3596.30.00	350WGSZ	1898 917 329
3597.30.00	350 WGTZ	1861 961 033
3597.30.00	350 WGTZ	1878 001 144
3599.30.00	350 GTZ	1878 001 070
3601.20.00	MF362	3482 125 533
3601.20.00	MF362	3482 000 461
3606.20.00	MF362	3482 000 462
3606.20.00	MF362	3482 126 331
3607.20.00	MF362	3482 000 419
3607.30.00	362WGTZ	1878 047 333
3607.30.00	362WGTZ	1878 063 531
3607.30.00	362WGTZ	1878 079 331
3608.20.00	MF362	3482 000 461
3608.20.00	MF362	3482 125 512

Comparison list by RUEN

RUEN reference	Parameter	Comparison refer.
SACHS >>		
3608.30.00	362WGTZ	1878 079 306
3610.20.00	MFZ362	3482 120 031
3610.30.00	362GTZ	1862 528 032
3610.30.00	362GTZ	1862 541 031
3610.30.00	362GTZ	1862 541 032
3610.30.00	362GTZ	1878 044 631
3611.30.00	362GTZ	1878 002 071
3612.30.00	362GTZ	1878 001 501
3613.30.00	362GTZ	1878 002 599
3613.30.00	362GTZ	1878 019 001
3617.30.00	362WGTZ	1878 006 847
3619.30.00	362WGTZ	1878 006 848
3620.20.00	MF362	3482 001 071
3620.90.01		3400 121 401
3620.90.02		3400 127 701
3620.90.03		3400 700 307
3620.90.05		3400 700 353
3620.90.06		3400 700 428
3620.90.07		3400 700 375
3620.90.08		3400 700 405
3620.90.09		3400 700 303
3620.90.10		3400 121 801
3620.90.11		3400 710 002
3620.90.19		3400 710 011
3620.90.28		3400 700 482
3620.90.28		3400 700 626
3620.90.29		3400 700 439
3620.90.30		3400 710 001
3620.90.32		3400 710 005
3620.90.42		3400 710 008
3620.90.50		3400 700 607
3620.90.51		3400 700 436
3620.90.52		3400 700 487
3626.30.00	362 WGTZ	1878 052 842
3627.30.00	362WGTB	1878 048 741
3627.30.00	362WGTB	1878 052 842
3800.90.10		3400 037 031
3800.90.14		3400 700 412
3800.90.48		3400 037 032
3800.90.52		3400 124 701
3801.20.00	G380KR	1882 325 001
3801.20.00	G380KR	1882 325 040
3802.20.00	G380KR	1882 325 033
3803.20.00	G380KR	1882 286 231
3804.20.00	G380KR	1882 325 034
3804.20.00	G380KR	1882 325 134
3805.30.00	380WGSZ	1861 351 305
3805.30.00	380WGSZ	1861 351 342
3806.30.00	380W2GSZ	1861 351 338
3806.30.00	380W2GSZ	1861 351 340
3806.30.00	380W2GSZ	1861 486 231
3806.30.00	380W2GSZ	1861 669 003
3806.30.00	380W2GSZ	1862 147 032
3806.30.00	380W2GSZ	1861 351 341
3806.30.00	380W2GSZ	1861 486 202
3806.30.00	380W2GSZ	1861 486 232
3806.30.00	380W2GSZ	1861 486 233
3806.30.00	380W2GSZ	1861 486 234
3806.30.00	380W2GSZ	1861 669 001
3806.30.00	380W2GSZ	1861 669 002
3806.30.00	380W2GSZ	1861 923 003
3806.30.00	380W2GSZ	1861 923 103
3806.30.00	380W2GSZ	1861 942 033
3806.30.00	380W2GSZ	1862 356 031

RUEN reference	Parameter	Comparison refer.
3806.30.00	380W2GSZ	1878 001 152
3807.20.00	G380KR	1881 041 656
3807.20.00	G380KR	1881 041 526
3807.20.00	G380KR	1881 041 556
3807.20.00	G380KR	1881 041 656
3808.30.00	380GSZ	1861 646 133
3808.30.00	380GSZ	1878 000 965
3810.20.00	G380KR	1882 325 032
38101.30.00	380GVZ	1861 906 032
38101.30.00	380GVZ	1861 996 034
38101.30.00	380GVZ	1861 996 137
38102.30.00	380GVZ	1861 907 132
38102.30.00	380GVZ	1861 997 034
38102.30.00	380GVZ	1861 997 137
38104.30.00	380GTZ	1878 006 117
38105.30.00	380GTZ	1861 997 137
38105.30.00	380GTZ	1878 006 035
38106.30.00	380WGTZ	1878 001 152
38107.30.00	380 GTZ	1878 000 105
38109.30.00	380GTZ	1862 308 031
38109.30.00	380GTZ	1878 007 339
38115.30.00	380GSZ	1862 235 001
38115.30.00	380GSZ	1878 000 957
3812.30.00	380GSZ	1861 321 139
3812.30.00	380GSZ	1861 329 139
3812.30.00	380GSZ	1878 000 104
3814.20.00	G380KR	1882 325 035
3814.20.00	G380KR	1882 325 134
3816.30.00	380GSZ	1861 579 131
3816.30.00	380GSZ	1861 861 031
3816.30.00	380GSZ	1861 861 032
3816.30.00	380GSZ	1878 000 957
3816.30.00	380GSZ	1878 000 959
3821.20.00	GF380KR	1882 302 101
3821.20.00	GF380KR	1882 302 131
3821.20.00	GF380KR	1882 331 033
3821.30.00	380GSZ	1861 494 103
3821.30.00	380GSZ	1861 494 140
3821.30.00	380GSZ	1862 308 031
3821.30.00	380GSZ	1878 000 105
3822.20.00	GF380KR	1882 166 707
3822.20.00	GF380KR	1882 166 737
3822.30.00	380GSZ	1861 219 009
3822.30.00	380GSZ	1861 219 157
3822.30.00	380GSZ	1878 000 104
3827.20.00	GF380KR	1882 302 102
3829.20.00	GF380KR	1882 327 001
3831.20.00	GF380KR	1882 302 105
3835.20.00	GF380	1882 302 131
3835.20.00	GF380	1882 302 134
3835.20.00	GF380	1882 331 033
3835.30.00	380GTZ	1861 489 131
3835.30.00	380GTZ	1861 489 133
3835.30.00	380GTZ	1861 489 139
3835.30.00	380GTZ	1861 584 108
3835.30.00	380GTZ	1861 699 103
3835.30.00	380GTZ	1861 699 109
3835.30.00	380GTZ	1861 863 233
3835.30.00	380GTZ	1861 932 003
3835.30.00	380GTZ	1861 932 005
3835.30.00	380GTZ	1878 000 967
3839.30.00	380GSZ	1861 584 036
3839.30.00	380GSZ	1861 584 137
3848.50.00	GF2/380	1859 212 001
3849.20.00	G380KR	1882 280 110
3849.20.00	G380KR	1882 280 140

Comparison list by RUEN

RUEN reference	Parameter	Comparison refer.
SACHS >>		
3849.20.00	G380KR	1888 280 110
3852.30.00	380GS	1861 599 102
3852.30.00	380GS	1878 000 105
3854.30.00	380GVZ	1862 243 033
3854.30.00	380GVZ	1862 243 035
3854.30.00	380GVZ	1862 305 033
3854.30.00	380GVZ	1862 305 034
3855.30.00	380GS	1862 135 003
3855.30.00	380GS	1862 135 035
3856.10.00	GF2/380	1888 015 346
3856.20.00	G380KR	1882 280 112
3857.10.00	GF2/380	1888 042 009
3857.20.00	G380KR	1882 341 001
3857.30.00	380W2GSZ	1861 486 231
3857.30.00	380W2GSZ	1878 001 152
3857.50.00	GF2/380	1859 250 101
3857.50.00	GF2/380	1859 250 102
3860.20.00	GM380K	3482 021 001
3860.20.00	GM380K	3482 021 031
3861.20.00	GM380	3482 021 002
3861.30.00	380W2GSZ	1861 435 333
3861.30.00	380W2GSZ	1861 435 334
3863.20.00	GM380	3482 000 270
3866.20.00	GM380K	3482 037 041
3866.20.00	GM380K	3482 037 141
3870.30.00	380/210GSZ	1861 489 101
3870.30.00	380/210GSZ	1861 863 233
3870.30.00	380/210GSZ	1878 000 967
3871.30.00	380/70GSZ	1861 488 131
3871.30.00	380/70GSZ	1861 488 140
3871.30.00	380/70GSZ	1861 862 233
3871.30.00	380/70GSZ	1878 000 964
3872.30.00	380GSZ	1861 413 134
3877.20.00	GMF380	3482 017 033
3878.20.00	GMF380	3482 017 034
3878.30.00	380/210GSZ	1861 799 101
3878.30.00	380/210GSZ	1861 799 131
3878.30.00	380/210GSZ	1861 799 133
3879.20.00	GMF380	3482 017 035
3882.10.00	GF2/380	1888 055 005
3882.10.00	GF2/380	1888 055 035
3882.10.00	GF2/380	1888 055 041
3882.20.00	GF2/380	1882 349 001
3882.20.00	GF2/380	1882 349 002
3882.20.00	GF2/380	1882 349 003
3882.30.00	380GSZ	1862 138 032
3882.50.00	GF2/380	1859 250 100
3885.30.00	380GSZ	1861 460 138
3885.30.00	380GSZ	1878 000 105
3886.30.00	380GSZ	1861 635 031
3886.30.00	380GSZ	1861 635 035
3886.30.00	380GSZ	1878 000 961
3887.10.00	GF2/380	1888 055 131
3887.10.00	GF2/380	1888 055 247
3888.30.00	380WGSZ	1861 923 002
3888.30.00	380WGSZ	1861 923 032
3888.30.00	380WGSZ	1862 356 031
3889.10.00	GF2/380	1888 015 523
3889.10.00	GF2/380	1888 015 524
3889.30.00	380GSZ	1862 122 031
3889.30.00	380GSZ	1862 122 131
3889.30.00	380GSZ	1862 122 132
3889.30.00	380GSZ	1862 122 134
3890.10.00	GF2/380	1888 015 515

RUEN reference	Parameter	Comparison refer.
3890.10.00	GF2/380	1888 015 542
3891.30.00	380GS	1862 123 131
3892.20.00	GF2/380	1878 000 968
3892.20.00	GF2/380	1882 280 213
3892.30.00	380GSZ	1861 699 101
3892.30.00	380GSZ	1861 699 131
3894.30.00	380GSZ	1861 748 101
3894.30.00	380GSZ	1861 748 132
3895.20.00	G380KR	1882 325 039
3895.20.00	G380KR	1882 325 139
3896.30.00	380WGSZ	1861 749 101
3896.30.00	380WGSZ	1861 749 102
3896.30.00	380WGSZ	1861 749 132
3897.30.00	380GSZ	1861 912 034
3897.30.00	380GSZ	1861 912 035
3897.30.00	380GSZ	1878 000 105
3899.30.00	380GSZ	1861 470 133
3899.30.00	380GSZ	1861 470 234
3903.40.00	KZIS-0	3151 130 141
3903.40.00	KZIS-0	3151 130 241
3950.90.01		3400 121 201
3950.90.02		3400 121 701
3950.90.03		3400 121 301
3950.90.06		3400 700 376
3950.90.07		3400 700 308
3950.90.08		3400 700 316
3950.90.09		3400 700 320
3950.90.12		3400 700 337
3950.90.15		3400 700 364
3950.90.20	395	3400 700 466
3950.90.21		3400 700 397
3950.90.24		3400 700 628
3950.90.25		3400 700 396
3950.90.31		3400 710 006
3950.90.32		3400 700 625
3950.90.32		3400 700 631
3950.90.33		3400 710 007
3950.90.34		3400 710 009
3950.90.35		3400 710 016
3950.90.36		3400 710 012
3950.90.37		3400 710 015
3950.90.38		3400 710 010
3950.90.39		3400 710 013
3950.90.40		3400 710 014
3950.90.42		3400 710 017
3951.20.00	MF395	3482 000 187
3951.20.00	MF395	3482 000 463
3951.20.00	MF395	3482 123 833
3951.30.00	395WGTZ	1862 506 131
3951.30.00	395WGTZ	1878 046 631
3952.20.00	MF395	3482 123 832
3952.20.00	MF395	3482 000 197
3952.20.00	MF395	3482 000 464
3952.30.00	395WGTZ	1878 000 036
3953.20.00	MF395	3482 000 474
3953.20.00	MF395	3482 123 839
3953.30.00	395WGTZ	1878 000 296
3953.30.00	395WGTZ	1878 007 279
3954.30.00	395WGTZ	1878 000 294
3956.20.00	MFZ395	3482 000 467
3956.20.00	MFZ395	3482 115 032
3957.20.00	MFZ395	3482 115 031
3957.30.00	395WGTZ	1878 006 713
3960.30.00	395GTZ	1878 023 931
3961.20.00	MF395	3482 634 003
3961.30.00	395GTZ	1878 003 784

Comparison list by RUEN

RUEN reference	Parameter	Comparison refer.
SACHS >>		
3961.30.00	395GTZ	1878 023 831
3962.30.00	395GTZ	1878 039 631
3971.30.00	395WGTZ	1878 004 232
3972.20.00	MF395	3482 000 679
3973.30.00	395WGTZ	1878 634 034
3974.30.00	395WGTZ	1878 007 939
4000.90.01		3400 121 901
4000.90.03		3400 121 601
4000.90.04		3400 121 501
4000.90.07		3400 117 532
4000.90.08		3400 700 422
4000.90.09		3400 700 423
4000.90.10		3400 700 406
4000.90.12		3400 700 311
4000.90.13		3400 700 340
4000.90.15		3400 700 407
4000.90.17		3400 700 355
4000.90.17		3400 700 315
4000.90.18	MFZ2/400X	3400 700 609
4000.90.19		3400 093 031
4000.90.20		3400 117 631
4000.90.28		3400 700 360
4000.90.29		3400 700 629
4000.90.60		3400 123 601
4000.90.61		3400 123 501
4001.10.00	MFZ2/400X	3488 017 333
4005.30.00	400GVZ	1862 317 031
4006.30.00	400GVZ	1862 317 032
4007.30.00	400WGTZ	1862 390 031
4007.30.00	400WGTZ	1878 032 032
4008.30.00	400 WGVZ	1862 364 133
4009.30.00	400WGVZ	1862 157 037
4009.30.00	400WGVZ	1862 364 031
4010.10.00	MFZ2/400X	3488 017 432
4010.30.00	400WGVZ	1862 303 031
4011.30.00	400GVZ	1862 302 031
4020.30.00	400GVZ	1862 193 105
4020.30.00	400GVZ	1878 005 805
4021.10.00	MFZ2/400X	3488 000 366
4021.30.00	400GVZ	1862 190 105
4022.10.00	MFZ2/400X	3488 000 065
4022.10.00	MFZ2/400X	3488 000 158
4025.10.00	MFZ2/400X	3488 017 448
4025.10.00	MFZ2/400X	3488 023 031
4025.10.00	MFZ2/400X	3488 023 032
4025.30.00	400WGTZ	1862 190 139
4025.30.00	400WGTZ	1878 002 019
4025.30.00	400WGTZ	1878 002 024
4025.30.00	400WGTZ	1878 005 031
4025.30.00	400WGTZ	1878 007 185
4025.30.00	400WGTZ	1878 056 331
4026.10.00	MFZ2/400X	3488 000 122
4026.10.00	MFZ2/400X	3488 017 439
4026.10.00	MFZ2/400X	3488 017 442
4026.30.00	400GTZ	1878 002 023
4026.50.00	MFZ2/400X	3459 018 004
4027.10.00	MFZ2/400X	3488 000 159
4027.10.00	MFZ2/400X	3488 022 253
4027.30.00	400WGVZ	1862 379 031
4027.60.00	MFZ2/400X	3483 034 135
4028.10.00	MFZ2/400X	3488 017 447
4029.10.00	MFZ2/400X	3488 017 442
4029.30.00	400GTZ	1862 379 032
4031.30.00	400GTZ	1878 000 635

RUEN reference	Parameter	Comparison refer.
4031.30.00	400GTZ	1878 002 442
4031.30.00	400GTZ	1878 032 233
4032.30.00	400WGTZ	1878 000 300
4032.30.00	400WGTZ	1878 003 768
4033.30.00	400WGTZ	1878 002 437
4033.30.00	400WGTZ	1878 032 133
4036.10.00	MFZ2/400X	3488 017 334
4036.30.00	400 WGTZ	1878 002 643
4037.30.00	400WGTZ	1862 514 031
4037.30.00	400WGTZ	1878 002 455
4047.10.00	MFZ2/400X	3488 000 024
4047.10.00	MFZ2/400X	3488 000 373
4051.30.00	400WGVZ	1862 454 031
4051.30.00	400WGVZ	1878 013 031
4051.30.00	400WGVZ	1878 013 132
4051.30.00	400WGVZ	1878 043 231
4052.30.00	400GVZ	1862 450 031
4055.30.00	400GVZ	1862 349 031
4060.26.00	MFZ400X	3482 112 032
4060.26.00	MFZ400X	3482 112 031
4060.60.00	MFZ400X	3483 028 031
4200.90.02		3400 121 002
4200.90.03		1800 125 501
4200.90.16		1800 125 301
4200.90.17		1800 125 301
4200.90.22		3400 700 305
4200.90.49		3400 119 001
4200.90.77		3400 125 701
4200.90.78		3400 124 601
4200.90.81		3400 700 319
4200.90.82		3400 121 101
4200.90.83		3400 121 001
4200.90.84		3400 125 901
4201.20.00	G420KR	1882 308 102
4203.20.00	G420KR	1882 226 402
4203.20.00	G420KR	1882 226 533
4203.30.00	420GS	1861 088 007
4203.30.00	420GS	1861 206 111
4203.30.00	420GS	1861 206 211
4203.30.00	420GS	1861 409 132
4205.20.00	G420KR	1882 308 103
4205.20.00	G420KR	1882 308 133
4208.30.00	420GS	1861 206 112
4208.30.00	420GS	1861 206 212
4208.30.00	420GS	1861 206 242
4208.30.00	420GS	1878 001 138
4209.30.00	420GS	1861 206 113
4210.30.00	420/210GSZ	1861 852 001
4210.30.00	420/210GSZ	1861 852 032
4210.30.00	420/210GSZ	1878 027 231
4211.20.00	G420KR	1882 226 433
4211.30.00	420/210GSZ	1861 762 101
4211.30.00	420/210GSZ	1861 762 133
4211.30.00	420/210GSZ	1862 273 031
4211.30.00	420/210GSZ	1862 273 131
4211.30.00	420/210GSZ	1878 003 365
4212.30.00	420/210GSZ	1861 760 034
4222.20.00	GF420KR	1882 301 237
4222.20.00	GF420KR	1882 330 002
4222.20.00	GF420KR	1882 330 032
4224.20.00	GF420KR	1882 301 239
4224.20.00	GF420KR	1882 330 031
4224.20.00	GF420KR	3482 124 534
4225.20.00	GF420KR	1882 330 033
4225.20.00	GF420KR	3482 124 534
4226.20.00	GF420KR	1882 316 033

Comparison list by RUEN

RUEN reference	Parameter	Comparison refer.
SACHS >>		
4226.20.00	GF420KR	3482 124 541
4231.30.00	420GSZ	1861 410 002
4231.30.00	420GSZ	1861 410 047
4232.30.00	420GSZ	1861 410 046
4234.20.00	GF420KR	1882 301 208
4234.20.00	GF420KR	1882 301 238
4234.20.00	GF420KR	3482 124 541
4234.30.00	420/210GSZ	1861 410 009
4235.20.00	GF420KR	1882 301 209
4235.20.00	GF420KR	1882 301 239
4235.30.00	420/210GS	1861 680 038
4236.20.00	GF420KR	1882 326 001
4236.20.00	GF420KR	1882 326 331
4236.20.00	GF420KR	3482 085 033
4236.30.00	420/210GSZ	1861 569 031
4236.30.00	420/210GSZ	1861 569 038
4236.30.00	420/210GSZ	1878 634 017
4237.20.00	GF420KR	1882 316 005
4237.20.00	GF420KR	3482 124 531
4240.30.00	420/210GSZ	1861 663 001
4244.20.00	GFX420KR	1882 342 134
4244.30.00	420/210GSZ	1861 527 002
4244.30.00	420/210GSZ	1861 527 033
4244.30.00	420/210GSZ	1861 986 135
4247.30.00	420GSZ	1861 663 002
4247.30.00	420GSZ	1861 663 033
4247.30.00	420GSZ	1862 126 032
4248.20.00	GFX420KR	1882 303 103
4248.20.00	GFX420KR	3482 118 031
4248.30.00	420W2GSZ	1861 443 102
4249.30.00	420W2GSZ	1878 001 154
4249.30.00	420W2GSZ	1861 521 231
4249.30.00	420W2GSZ	1861 521 234
4249.30.00	420W2GSZ	1878 001 154
4250.20.00	GFX420KR	1882 303 102
4250.20.00	GFX420KR	3482 124 522
4250.30.00	420WGSZ	1861 639 004
4250.30.00	420WGSZ	1861 639 006
4250.30.00	420WGSZ	1861 639 031
4250.30.00	420WGSZ	1861 639 032
4250.30.00	420WGSZ	1861 639 035
4250.30.00	420WGSZ	1861 639 107
4250.30.00	420WGSZ	1861 639 148
4250.30.00	420WGSZ	1878 003 657
4253.20.00	GFX420KR	1882 342 133
4253.20.00	GFX420KR	1882 342 134
4253.20.00	GFX420KR	3482 124 516
4254.30.00	420GSZ	1861 672 031
4254.30.00	420GSZ	1861 672 033
4255.30.00	420GS	1861 482 034
4255.30.00	420GS	1891 986 135
4256.20.00	GMF420K	3482 018 132
4256.20.00	GMF420K	3482 018 202
4256.20.00	GMF420K	3482 018 205
4256.20.00	GMF420K	3482 119 031
4256.30.00	420GS	1861 986 135
4257.20.00	GMF420K	3482 018 101
4257.20.00	GMF420K	3482 018 231
4257.20.00	GMF420K	3482 119 032
4257.30.00	420GSZ	1861 410 015
4257.30.00	420GSZ	1861 410 048
4258.30.00	420GSZ	1861 410 006
4258.30.00	420GSZ	1861 410 016
4258.30.00	420GSZ	1861 410 046

RUEN reference	Parameter	Comparison refer.
4259.30.00	420GSZ	1861 986 140
4259.30.00	420GSZ	1878 086 742
4261.20.00	GMF420K	3482 001 101
4261.20.00	GMF420K	3482 001 139
4261.20.00	GMF420K	3482 124 514
4261.30.00	420GSZ	1861 598 103
4261.30.00	420GSZ	1861 598 133
4261.30.00	420GSZ	1861 670 002
4261.30.00	420GSZ	1861 680 002
4261.30.00	420GSZ	1861 680 036
4261.30.00	420GSZ	1861 680 037
4261.30.00	420GSZ	1861 680 107
4261.30.00	420GSZ	1861 680 149
4261.30.00	420GSZ	1878 003 238
4263.20.00	GMF420K	3482 001 104
4263.20.00	GMF420K	3482 001 134
4263.20.00	GMF420K	3482 001 234
4263.20.00	GMF420K	3482 119 034
4266.30.00	420/210GSZ	1861 760 034
4268.20.00	GMF420K	3482 001 107
4268.30.00	420GSZ	1861 560 204
4268.30.00	420GSZ	1861 560 234
4269.20.00	GMF420K	3482 001 136
4269.20.00	GMF420K	3482 124 542
4272.30.00	420WGSZ	1861 715 032
4272.30.00	420WGSZ	1861 715 035
4272.30.00	420WGSZ	1878 003 657
4277.20.00	GFX420KR	1882 335 233
4277.20.00	GFX420KR	1882 335 236
4278.20.00	GFX420KR	1882 335 234
4278.30.00	420W2GSZ	1861 724 003
4278.30.00	420W2GSZ	1861 724 104
4278.30.00	420W2GSZ	1861 724 137
4281.30.00	420WGVZ	1861 911 232
4281.30.00	420WGVZ	1861 911 245
4281.30.00	420WGVZ	1861 911 303
4281.30.00	420WGVZ	1862 227 034
4283.30.00	420WGSZ	1861 480 331
4283.30.00	420WGSZ	1861 480 335
4283.30.00	420WGSZ	1878 001 155
4286.30.00	420WGTZ	1861 985 105
4286.30.00	420WGTZ	1861 560 234
4286.30.00	420WGTZ	1861 526 046
4286.30.00	420WGTZ	1861 545 131
4286.30.00	420WGTZ	1861 545 133
4286.30.00	420WGTZ	1861 560 232
4286.30.00	420WGTZ	1862 220 032
4286.30.00	420WGTZ	1878 002 955
4286.30.00	420WGTZ	1878 086 941
4286.30.00	420WGTZ	1878 634 025
4287.30.00	420GVZ	1861 876 033
4287.30.00	420GVZ	1861 876 134
4287.30.00	420GVZ	1861 980 033
4287.30.00	420GVZ	1878 086 741
4289.30.00	420GSZ	1861 643 134
4289.30.00	420GSZ	1862 268 031
4290.30.00	420GSZ	1862 133 032
4290.30.00	420GSZ	1862 133 033
4291.30.00	420GSZ	1861 526 003
4291.30.00	420GSZ	1861 526 014
4291.30.00	420GSZ	1861 903 002
4291.30.00	420GSZ	1861 903 032
4291.30.00	420GSZ	1861 903 033
4291.30.00	420GSZ	1878 003 276

Comparison list by RUEN

RUEN reference	Parameter	Comparison refer.
SACHS >>		
4291.30.00	420GSZ	1878 037 001
4292.30.00	420GSZ	1861 903 034
4293.30.00	420GSZ	1862 588 003
4293.30.00	420GSZ	1862 588 004
4296.20.00	GF420	1882 301 240
4297.30.00	420GSZ	1861 941 032
4297.30.00	420GSZ	1861 941 033
4297.30.00	420GSZ	1878 001 136
4298.20.00	GF420	1882 316 038
4298.20.00	GF420	3482 124 532
4298.30.00	420GSZ	1861 526 037
4299.20.00	GFX420K	1882 337 031
4299.20.00	GFX420K	3482 124 533
4299.30.00	420GSZ	1861 572 431
4299.30.00	420GSZ	1861 860 131
4300.20.00	MFZ430	3482 081 233
4300.20.00	MFZ430	3482 083 031
4300.20.00	MFZ430	3482 083 113
4300.30.00	430GTZ	1862 315 101
4300.30.00	430GTZ	1878 085 641
4300.50.09		3400 122 001
4300.90.01		3400 122 601
4300.90.01		3400 124 001
4300.90.02		3400 117 802
4300.90.02		3400 700 455
4300.90.03		3400 700 304
4300.90.03		3400 122 101
4300.90.04		3400 117 801
4300.90.05		3400 122 201
4300.90.051		3400 122 201
4300.90.06		3400 005 035
4300.90.07		3400 122 901
4300.90.09		3400 710 004
4300.90.09		3400 122 001
4300.90.10		3400 123 901
4300.90.101		3400 700 402
4300.90.102		3400 700 460
4300.90.103		3400 700 404
4300.90.104		3400 700 445
4300.90.105		3400 700 459
4300.90.106		3400 700 463
4300.90.109		3400 700 366
4300.90.11		3400 123 701
4300.90.110		3400 700 461
4300.90.111		3400 700 372
4300.90.112		3400 700 371
4300.90.112		3400 700 611
4300.90.113		3400 700 352
4300.90.114		3400 700 324
4300.90.116		3400 700 438
4300.90.117		3400 700 470
4300.90.118		3400 700 478
4300.90.119		3400 700 382
4300.90.12		3400 700 404
4300.90.128		3400 700 357
4300.90.129		3400 700 600
4300.90.13		3400 700 403
4300.90.14		3400 122 101
4300.90.15		3400 122 801
4300.90.15		3400 700 413
4300.90.16		3400 700 342
4300.90.17		3400 700 332
4300.90.171		3400 700 361
4300.90.175		3400 700 395

RUEN reference	Parameter	Comparison refer.
4300.90.176		3400 700 435
4300.90.177		3400 700 313
4300.90.178		3400 700 462
4300.90.179		3400 700 469
4300.90.18		3400 123 001
4300.90.181		3400 700 504
4300.90.188		3400 700 521
4300.90.189		3400 700 522
4300.90.20		3400 127 401
4300.90.202		3400 700 494
4300.90.21		3400 106 031
4300.90.21		3400 127 201
4300.90.212		3400 700 370
4300.90.213		3400 700 373
4300.90.214		3400 700 619
4300.90.22		3400 035 032
4300.90.222		3400 700 374
4300.90.23		3400 700 401
4300.90.232		3400 700 491
4300.90.24		3400 123 801
4300.90.28		3400 122 501
4300.90.29		3400 700 411
4300.90.30		3400 124 101
4300.90.33		3400 043 032
4300.90.334		3400 700 604
4300.90.34		3400 127 101
4300.90.349		3400 123 101
4300.90.35		3400 700 343
4300.90.350		3400 117 201
4300.90.36		3400 005 036
4300.90.37		3400 005 034
4300.90.38		3400 700 331
4300.90.381		3400 700 415
4300.90.382		3400 700 468
4300.90.39		3400 700 334
4300.90.40		3400 700 408
4300.90.41		3400 700 410
4300.90.42		3400 700 418
4300.90.44		3400 700 345
4300.90.46		3400 123 301
4300.90.47		3400 116 901
4300.90.48		3400 117 202
4300.90.49		3400 122 301
4300.90.50		3400 122 701
4300.90.51		3400 700 354
4300.90.52		3400 127 401
4300.90.52		3400 700 380
4300.90.53		3400 700 402
4300.90.54		3400 700 330
4300.90.55		3400 700 333
4300.90.56		3400 700 381
4300.90.56		3400 700 450
4300.90.60		3400 700 409
4300.90.61		3400 123 401
4300.90.62		3400 700 350
4300.90.63		3400 700 351
4300.90.64		3400 700 357
4300.90.65		3400 700 344
4300.90.68		3400 700 365
4300.90.69		3400 700 368
4300.90.72		3400 700 361
4300.90.74		3400 700 335
4300.90.75		3400 700 329
4300.90.76		3400 040 032
4300.90.78		3400 700 414
4300.90.89		3400 700 467

Comparison list by RUEN

RUEN reference	Parameter	Comparison refer.
SACHS >>		
4300.90.90		3400 700 446
4300.90.91		3400 700 399
4300.90.94		3400 700 378
4300.90.97		3400 700 489
4300.90.98		3400 700 495
4300.90.99		3400 117 101
4301.20.00	MFZ430	3482 083 032
4301.20.00	MFZ430	3482 083 119
4302.30.00	430GTZ	1862 176 034
4302.30.00	430GTZ	1878 062 944
4303.20.00	MFZ430	3482 000 573
4303.20.00	MFZ430	3482 083 032
4303.20.00	MFZ430	3482 083 041
4304.20.00	MFZ430	3482 081 231
4304.20.00	MFZ430	3482 083 118
4304.26.00	MFZ430	3482 123 234
4304.26.00	MFZ430	3482 123 235
4304.30.00	430WGTZ	1862 216 032
4304.30.00	430WGTZ	1878 005 668
4304.30.00	430WGTZ	1878 065 131
4304.30.00	430WGTZ	1878 086 741
4305.20.00	MFZ430	3482 081 232
4305.30.00	430W2GTZ	1862 188 032
4305.30.00	430W2GTZ	1862 215 032
4305.30.00	430W2GTZ	1862 283 133
4305.30.00	430W2GTZ	1862 519 137
4305.30.00	430W2GTZ	1862 519 259
4305.30.00	430W2GTZ	1878 000 116
4305.30.00	430W2GTZ	1878 002 729
4305.30.00	430W2GTZ	1878 004 832
4305.30.00	430W2GTZ	1878 022 841
4305.30.00	430W2GTZ	1878 080 035
4305.30.00	430W2GTZ	1878 634 027
4306.30.00	430WGTZ	1878 080 033
4307.20.00	MFZ430	3482 000 852
4307.20.00	MFZ430	3482 081 233
4308.20.00	MFZ430	3482 083 145
4309.30.00	430WGVZ	1861 971 141
4310.30.00	430WGVZ	1862 208 032
4310.60.00	MFZ430	3483 020 034
43100.20.00	MFZ430E	3482 000 042
43104.20.00	MFZ430	3482 001 184
4311.20.00	MFZ430	3482 083 034
4311.26.00	MFZ430	3482 123 243
4311.26.00	MFZ430	3482 123 441
4311.30.00	430W2GTZ	1878 020 241
4312.30.00	430W2GTZ	1862 216 032
4312.30.00	430W2GTZ	1878 026 241
4313.20.00	MFZ430	3482 000 151
4313.20.00	MFZ430	3482 000 251
4313.20.00	MFZ430	3482 083 034
4313.20.00	MFZ430	3482 083 039
4313.26.00	MFZ430	3482 083 039
4313.30.00	430WGTZ	1878 001 030
4313.30.00	430WGTZ	1878 022 841
4313.30.00	430WGTZ	1878 080 035
43134.30.00	430WGTZ	1878 004 573
4314.30.00	430WGTZ	1878 061 841
4316.30.00	430WGTZ	1878 000 055
4316.30.00	430WGTZ	1878 080 031
4316.30.00	430WGTZ	1878 237 831
4318.30.00	430WGTZ	1862 519 034
4318.30.00	430WGTZ	1862 519 139
4318.30.00	430WGTZ	1862 519 240

RUEN reference	Parameter	Comparison refer.
4318.30.00	430WGTZ	1878 000 299
4318.30.00	430WGTZ	1878 002 730
4318.30.00	430WGTZ	1878 005 165
4318.30.00	430WGTZ	1878 007 072
4318.30.00	430WGTZ	1878 634 024
4318.60.00	MFZ430	3483 030 031
4319.20.00	MFZ430	3482 000 196
4319.20.00	MFZ430	3482 000 361
4321.30.00	430 WGTZ	1862 326 031
4323.30.00	430WGTZ	1862 530 231
4325.30.00	430WGTZ	1878 000 634
4325.30.00	430WGTZ	1878 001 215
4326.30.00	430WGTZ	1878 085 741
4327.30.00	430GTZ	1861 992 432
4327.30.00	430GTZ	1878 054 951
4328.20.00	MFZ430	3482 083 150
4329.30.00	430WGTZ.	1878 000 948
4329.30.00	430WGTZ.	1878 003 867
4329.30.00	430WGTZ.	1878 006 584
4329.60.00	MFZ430	3483 030 032
4330.60.00	MFZ430	3483 020 033
4331.30.00	430WGTZ	1878 002 504
4331.30.00	430WGTZ	1878 002 733
4331.30.00	430WGTZ	1878 054 031
4331.30.00	430WGTZ	1878 634 026
4331.60.00	MFZ430	3483 020 036
4332.30.00	430GTZ	1878 000 205
4332.30.00	430GTZ	1878 003 647
4332.60.00	MFZ430	3483 034 032
4332.60.00	MFZ430	3483 034 033
4333.30.00	430WGTZ	1862 326 032
4333.30.00	430WGTZ	1862 461 031
4333.30.00	430WGTZ	1862 461 132
4333.30.00	430WGTZ	1878 003 066
4333.30.00	430WGTZ	1878 037 631
4333.30.00	430WGTZ	1878 063 231
4333.60.00	MFZ430	3483 034 034
4334.30.00	430GTZ	1878 040 631
4334.30.00	430GTZ	1878 054 933
4334.60.00	MFZ430	3483 020 035
4335.30.00	430GTZ	1861 988 031
4335.30.00	430GTZ	1861 988 034
4335.30.00	430GTZ	1878 000 206
4336.60.00	MFZ430	3483 034 042
4338.30.00	430WGTZ	1878 003 767
4339.20.00	MFZ430	3482 000 195
4339.20.00	MFZ430	3482 000 246
4339.20.00	MFZ430	3482 123 534
4339.30.00	430WGTZ	1878 004 581
4340.60.00	MFZ430	3483 000 258
4342.30.00	430GTZ	1861 971 141
4342.30.00	430GTZ	1878 027 442
4342.30.00	430GTZ	1898 105 635
4343.30.00	430GTZ	1861 927 232
4343.30.00	430GTZ	1862 208 001
4343.30.00	430GTZ	1862 208 032
4343.30.00	430GTZ	1878 022 841
4343.30.00	430GTZ	1898 180 395
4343.30.00	430GTZ	1898 917 153
4346.30.00	430WGTZ	1862 108 031
4346.30.00	430WGTZ	1862 108 034
4346.30.00	430WGTZ	1862 109 034
4346.30.00	430WGTZ	1862 217 032
4346.30.00	430WGTZ	1862 217 033
4346.30.00	430WGTZ	1862 217 235
4346.30.00	430WGTZ	1862 217 335

Comparison list by RUEN

RUEN reference	Parameter	Comparison refer.
SACHS >>		
4346.30.00	430WGTZ	1862 217 337
4346.30.00	430WGTZ	1862 419 101
4346.30.00	430WGTZ	1878 001 030
4346.30.00	430WGTZ	1878 004 832
4346.30.00	430WGTZ	1878 023 731
4346.30.00	430WGTZ	1878 037 834
4346.30.00	430WGTZ	1878 037 838
4346.30.00	430WGTZ	1878 054 953
4346.30.00	430WGTZ	1878 080 034
4346.30.00	430WGTZ	1878 080 035
4346.30.00	430WGTZ	1878 080 037
43460.30.00	430WGTZ	1878 039 831
43460.30.00	430WGTZ	1862 441 031
43460.30.00	430WGTZ	1862 441 131
43460.30.00	430WGTZ	1878 037 844
43460.30.00	430WGTZ	1878 037 857
43460.30.00	430WGTZ	1878 080 034
43461.30.00	430WGTZ	1878 004 832
43461.30.00	430WGTZ	1878 005 541
4349.60.00	MFZ430	3483 000 422
4350.30.00	430WGTZ	1878 002 730
4350.30.00	430WGTZ	1862 519 034
4350.30.00	430WGTZ	1862 519 139
4350.30.00	430WGTZ	1862 519 240
4350.30.00	430WGTZ	1878 000 299
4350.30.00	430WGTZ	1878 002 730
4350.30.00	430WGTZ	1878 005 165
4350.30.00	430WGTZ	1878 007 072
4350.30.00	430WGTZ	1878 634 024
4351.30.00	430WGTZ	1862 529 032
4351.30.00	430WGTZ	1878 000 117
4351.30.00	430WGTZ	1878 002 732
4352.30.00	430WGTZ	1878 006 101
4356.30.00	430WGTZ	1862 226 131
4356.30.00	430WGTZ	1862 226 346
4356.30.00	430WGTZ	1862 226 511
4356.30.00	430WGTZ	1862 418 031
4356.30.00	430WGTZ	1862 494 031
4356.30.00	430WGTZ	1878 000 055
4356.30.00	430WGTZ	1878 031 002
4356.30.00	430WGTZ	1878 031 032
4356.30.00	430WGTZ	1878 031 048
4356.30.00	430WGTZ	1878 037 831
4356.30.00	430WGTZ	1878 037 854
4356.30.00	430WGTZ	1878 080 031
4366.30.00	430WGTZ	1878 085 742
4371.20.00	MFZ430	3482 000 484
4378.20.00	MFZ430	3482 124 731
4380.30.00	430WGTZ	1878 032 331
4382.60.00	MFZ430	3482 000 556
4382.60.00	MFZ430	3483 000 348
4384.60.00	MFZ430	3483 000 382
4385.60.00	MFZ430	3483 034 043
4386.30.00	430WGTZ	1878 001 938
4386.30.00	430WGTZ	1878 002 139
4386.30.00	430WGTZ	1878 038 041
4387.20.00	MFZ430	3482 000 819
4387.30.00	430WGTZ	1878 005 411
4389.30.00	430WGTZ	1878 003 868
4389.30.00	430WGTZ	1878 006 129
4390.20.00	MFZ430	3482 000 691
4390.30.00	430WGTZ	1878 004 132
4392.30.00	430WGTZ	1878 006 854
4392.30.00	430WGTZ	1878 003 969

RUEN reference	Parameter	Comparison refer.
4392.30.00	430WGTZ	1878 007 120
4392.30.00	430WGTZ	1878 007 123
4393.20.00	MFZ430	3482 000 257
4393.30.00	430WGTZ	1878 003 065
4393.30.00	430WGTZ	1878 056 732
4394.20.00	MFZ430	3482 000 556
4394.20.00	MFZ430	3482 000 999
4394.30.00	430WGTZ	1878 007 124
4394.30.00	430WGTZ	1878 007 254
4395.20.00	MFZ430	3482 634 004
4398.30.00	430WGTZ	1878 007 046
4399.30.00	430WGTZ	1878 003 968
4500.40.00	KZIZ - 3	3151 213 031
4500.40.00	KZIZ - 3	3151 600 529
4502.40.00	KZI - 1	3151 065 031
5501.40.00	KZISZ - 3	3151 220 031
5700.40.00	KZIZ - 3	3151 170 131
5800.40.00	KZA - 2	1850 282 653
5902.40.00	KZA - 4	3151 824 002
6901.40.00	KZI - 3	3151 044 031
6905.40.00	KZIS - 3	3151 199 001
6907.40.00	KZI - 3	3151 116 031
6907.40.00	KZI - 3	3151 999 116
6908.40.00	KZ - 3	3151 033 031
6909.40.00	KZI - 3	3151 095 043
6915.40.00	KZI - 4	3151 094 041
7451.40.00	KZIS-4	3151 221 001
7451.40.00	KZIS-4	3151 000 419
7802.40.00	KZA - 4	3151 824 005
7903.40.00	KZI-4	3151 600 540
7951.40.00	KZIS - 4	3151 000 395
7951.40.00	KZIS - 4	3151 152 102
8302.40.00	KZI - 4	3151 051 031
8500.40.00	KZI - 4,5	3151 000 375
8500.40.00	KZI - 4,5	3151 027 131
8502.40.00	KZI - 4	3151 087 041
8503.40.00	KZI - 4,5	3151 043 032
8505.40.00	KZI - 4,5	3151 000 395
8505.40.00	KZI - 4,5	3151 066 002
8505.40.00	KZI - 4,5	3151 066 032
8505.40.00	KZI - 4,5	3151 157 001
8509.40.00	KZI - 4,5	3151 043 031
8510.40.00	KZI - 4,5	3151 071 032
8510.40.00	KZI - 4,5	3151 114 031
8511.40.00	KZI - 4,5	3151 126 031
8512.40.00	KZI - 4,5	3151 127 031
8513.40.00	KZI - 4,5	3151 110 031
8514.40.00	KZI - 4,5	3151 101 031
8514.40.00	KZI - 4,5	3151 000 512
8514.40.00	KZI - 4,5	3151 000 515
8514.40.00	KZI - 4,5	3151 007 301
8514.40.00	KZI - 4,5	3151 007 303
8514.40.00	KZI - 4,5	3151 058 001
8516.40.00	KZI - 4,5	3151 067 032
8520.40.00	KZI - 4,5	3151 108 031
8526.40.00	KZI-4	1897 376 558
8526.40.00	KZI-4	3151 000 285
8529.40.00	KZI - 4,5	3151 000 374
8529.40.00	KZI - 4,5	3151 112 031
8529.40.00	KZI - 4,5	3151 272 631
8532.40.00	KZI - 4,5	3151 054 032
8533.40.00	KZI - 4,5	3151 000 958
8533.40.00	KZI - 4,5	3151 067 031
8535.40.00	KZIZ - 4,5	3151 253 031
8540.40.00	KZIS-4	3151 000 396
8540.40.00	KZIS-4	3151 261 031

Comparison list by RUEN

RUEN reference	Parameter	Comparison refer.
SACHS >>		
8541.40.00	KZIS-4	3151 000 397
8543.40.00	KZIS-4	3151 000 752
8544.40.00		3151 600 595
8601.47.00		3182 600 141
8602.47.00		3182 600 166
8603.47.00	HHIS-3	3182 008 032
8603.47.00	HHIS-3	3182 008 037
8603.47.00	HHIS-3	3182 008 039
8603.47.00	HHIS-3	3182 998 501
8604.47.00		3182 600 172
8631.47.00	HHISZ-4	3182 006 131
8631.47.00	HHISZ-4	3182 006 231
8631.47.00	HHISZ-4	3182 006 531
8631.47.00	HHISZ-4	3182 009 936
8631.47.00	HHISZ-4	3182 009 938
8633.47.00	HHISZ-3	3182 005 031
8633.47.00	HHISZ-3	3182 005 131
8633.47.00	HHISZ-3	3182 005 231
8641.47.00	PHIS-6/38	6482 000 087
8641.47.00	PHIS-6/38	6482 000 155
8653.47.00	HHIS-3	3182 008 037
8653.47.00	HHIS-3	3182 600 101
8900.40.00	KZI - 5	3151 105 041
8900.40.00	KZI - 5	3151 105 141
8901.40.00	KZI - 5	3151 106 041
8905.40.00	KZIZ - 5	3151 246 031
8916.40.00	KZIZ - 5	3151 169 031
8916.40.00	KZIZ - 5	3151 000 034
8916.40.00	KZIZ - 5	3151 169 131
8916.40.00	KZIZ - 5	3151 169 332
8916.40.00	KZIZ - 5	3151 273 431
8917.40.00	KZIZ - 5	3151 245 032
8918.40.00	KZISZ - 5	3100 002 255
8918.40.00	KZISZ - 5	3151 000 155
8918.40.00	KZISZ - 5	3151 259 001
8918.40.00	KZISZ - 5	3151 259 031
8918.40.00	KZISZ - 5	3180 000 001
8919.40.00	KZISZ - 5	3151 000 144
8919.40.00	KZISZ - 5	3151 203 031
8919.40.00	KZISZ - 5	3151 225 001
8919.40.00	KZISZ - 5	3151 225 031
8922.40.00	KZISZ-5	3100 000 003
8923.40.00	KZIZ - 5	3151 000 272
8923.46.00	KZIZ-5	3100 008 001
8923.46.00	KZIZ-5	3100 008 101
8923.46.00	KZIZ-5	3100 008 201
8923.46.00	KZIZ-5	3151 228 101
8923.46.00	KZIZ-5	3151 228 201
8924.40.00	KZIZ5	3151 000 148
8925.40.00	KZISZ-5	3151 000 163
8928.40.00	KZIZ - 5	3151 245 031
8929.46.00	KZIZ-5	3100 026 431
8930.40.00	KZI/Z-5	3151 123 031
8931.40.00	KZISZ-5	3151 000 217
8932.40.00	KZISZ - 5	3151 000 404
8932.40.00	KZISZ - 5	3151 250 332
8933.40.00	KZISZ - 5	3151 274 131
8934.40.00	KZISZ - 5	3151 000 151
8935.40.00	KZISZ - 5	3151 000 157
8935.40.00	KZISZ - 5	3151 195 032
8935.40.00	KZISZ - 5	3151 195 033
8936.40.00	KZISZ - 5	3151 000 493
8936.40.00	KZISZ - 5	3151 234 132
8936.46.00	KZISZ-5	3100 008 106

RUEN reference	Parameter	Comparison refer.
8937.40.00	KZISZ-5	3151 250 231
8938.46.00		3100 008 104
8938.46.00		3100 008 204
8939.40.00	KZISZ - 5	3151 000 493
8940.40.00	KZISZ-5	3151 278 941
8941.40.00	KZISZ-5	3151 262 031
8946.46.00	KZIZ-5	3100 026 433
8947.40.00	KZISZ-5	3151 001 083
8948.40.00	KZIZ-5	3151 000 273
8949.40.00		3151 001 035
8995.40.00	KZIZ-6	3151 263 031
9101.40.00	KZI - 5	3151 182 233
9302.40.00	KZI-6	3151 166 031
VALEO		
1800.90.02		801 939
1801.20.00	T180120	802 308
1801.30.00	180DE2R	803 393
2023.20.00	DB200	079 800
2023.20.00	DB200	094 492
2023.20.00	DB200	279 165
2023.20.00	DB200	279 421
2023.20.00	DB200	802 321
2034.30.00	200CE	279 379
2042.20.00	CP20	263 105
2042.20.00	CP20	279 458
2150.90.03		003 462
2150.90.07		801 250
2150.90.10		801 040
2150.90.18		003 398
2157.30.00	215PSD	266 938
2157.30.00	215PSD	355 542
2157.30.00	215PSD	355 592
2171.20.00	MF215K	264 635
2171.20.00	MF215K	358 320
2172.30.00	215D	355 575
2172.30.00	215D	355 576
2173.20.00	M215	279 103
2185.20.00	CP215	266 923
2185.20.00	CP215	267 426
2198.30.00	215CE	378 662
2280.90.02		801 435
2280.90.03		801 546
2282.20.00	M228KR	358 262
2282.20.00	M228KR	805 602
2283.20.00	M228KR	358 262
2306.30.00	228GSB	806 183
2307.30.00	228CB	358 279
2350.90.01		801 409
2353.20.00	MFZ235	805 531
2400.90.01		006 757
2400.90.05		826 585
2402.20.00	MF240	279 118
2402.30.00	240PSD	279 375
2403.20.00	MF240	279 389
2403.20.00	MF240	358 200
2504.30.00	250CBL	806 137
2507.20.00	HBX250	355 125
2514.20.00	H250K	261 673
2514.30.00	250CBL	806 137
2517.20.00	G250K	805 749
2517.30.00	250	806 411
2518.20.00	G250	805 750
2528.30.00	250BHZX	806 019
2528.30.00	250BHZX	807 540
2802.20.00	G280	805 707

Comparison list by RUEN

RUEN reference	Parameter	Comparison refer.
VALEO >>		
2802.30.00	280BHZ	806 393
2803.20.00	G280	805 754
2810.20.00	H280K	472 020
2810.30.00	280CBL	806 092
2812.20.00	HVB280	357 978
2822.20.00	MF280	279 002
2822.20.00	MF280	279 726
2822.20.00	MF280	805 507
2822.30.00	280GTZ	806 113
2823.20.00	MF280	357 978
2832.30.00	280GTZ	806 481
2953.20.00	GF295	355 131
2954.30.00	295BHZ	355 132
3101.20.00	GFX310	805 645
3119.20.00	GFX310	805 648
3120.20.00	GFX310	355 140
3122.20.00	GFX310	805 691
3126.30.00	310GSBL	355 338
3131.20.00	G310	805 752
3132.30.00	310GSB	829 309
3133.30.00	310GSBL	583 314
3133.30.00	310GSBL	583 314 TUR.
3133.30.00	310GSBL	829 309 TUR.
3133.30.00	310GSBL	829 367
3133.30.00	310GSBL	829 367 TUR.
3136.30.00	310WGSZ	806 117
3162.20.00	MF310	805 607
3162.30.00	310GTD	806 196
3164.20.00	MF310	805 525
3173.20.00	MF310	264 134
3173.20.00	MF310	805 518
3179.20.00	MFZ310	805 570
3189.20.00	MFZ 310	805 570 TUR.
3203.40.00	KZIS - 1	355 591
3205.40.00	KZIS - 0	804 022
3206.40.00	KZIS - 1	358 275
3211.40.00	KZIS - 0	264 630
3212.40.00	KZI - 0	804 106
3214.40.00	KZI/T - 1	355 591
3214.40.00	KZI/T - 1	804 019
3216.40.00	KZAS - 0	265 315
3224.40.00	KZAS - 00	266 121
3233.40.00	KZAS - 0B	804 007
3300.20.00	GFM330	358 295
3300.30.00	330GSZ	358 296
3300.90.01		805 037
3305.20.00	GMF330	805 564
3309.30.00	330GSZ	806 128
3312.20.00	MFZ330	805 612
3325.30.00	330WGSZ	806 432
3510.30.00	350W2GSZ	355 164
3516.10.00	GF2/350	805 172
3517.30.00	350WGSZ	806 450
3519.30.00	350GSZ	355 128
3520.20.00	GF350KR	355 110
3521.20.00	GF350KR	355 104
3522.20.00	GF350KR	355 106
3522.20.00	GF350KR	355 108
3527.30.00	350GSZ	355 177
3528.30.00	350GSZ	355 176
3530.30.00	350GSZ	355 155
3539.20.00	GF350	805 722
3561.30.00	350GSZ	358 343
3562.20.00	GMF350	358 282

RUEN reference	Parameter	Comparison refer.
3563.20.00	GMF350	358 192
3565.20.00	GMF350	358 280
3570.30.00	350Z	806 013
3574.20.00	14" MF 350	805 508
3574.20.00	14" MF 350	831 320
3574.20.00	14" MF 350	831 322
3574.30.00	14" 350GSZ	829 346
3574.30.00	14" 350GSZ	829 348
3578.30.00	14" 350GSZ	582 597
3580.20.00	GMF350	582 472
3580.20.00	GMF350	805 566
3583.30.00	350GSZ	806 018
3592.30.00	14" 350GSZ	829 347
3597.30.00	350 WGTZ	829 366
3606.20.00	MF362	805 779
3626.30.00	362 WGTZ	807 513
3801.20.00	G380KR	355 145
3804.20.00	G380KR	355 111
3804.20.00	G380KR	805 748
3806.30.00	380W2GSZ	806 203
3807.20.00	G380KR	805 646
3808.30.00	380GSZ	806 166
3812.30.00	380GSZ	357 810
3812.30.00	380GSZ	358 810
3821.20.00	GF380KR	355 165
3821.30.00	380GSZ	806 021
3822.20.00	GF380KR	355 146
3822.30.00	380GSZ	355 130
3827.20.00	GF380KR	355 167
3829.20.00	GF380KR	358 331
3831.20.00	GF380KR	805 551
3839.30.00	380GSZ	806 165
3849.20.00	G380KR	805 589
3852.30.00	380GS	358 333
3857.10.00	GF2/380	805 175
3857.20.00	G380KR	805 708
3860.20.00	GM380K	805 643
3866.20.00	GM380K	263 645
3866.20.00	GM380K	279 014
3868.20.00	15" GM380	831 317
3877.20.00	GMF380	805 615
3878.20.00	GMF380	358 332
3878.30.00	380/210GSZ	806 198
3882.10.00	GF2/380	805 176
3882.20.00	GF2/380	805 601
3882.30.00	380GSZ	806 120
3884.30.00	15" 380GSZ	829 365
3886.30.00	380GSZ	807 722
3892.30.00	380GSZ	806 315
3896.30.00	380WGSZ	806 474
3903.40.00	KZIS-0	264 169
3903.40.00	KZIS-0	265 254
3903.40.00	KZIS-0	279 675
3951.20.00	MF395	805 842
3961.30.00	395GTZ	829 358
3962.20.00	15.5" MF 395	805 842
3965.30.00	15.5" 395GTZ	829 355
4000.90.07		809 047
4025.30.00	400WGTZ	829 025
4026.10.00	MFZ2/400X	831 001
4026.30.00	400GTZ	829 026
4027.30.00	400WGVZ	829 021
4028.30.00	400GTZ	829 022
4201.20.00	G420KR	355 102
4203.30.00	420GS	806 476
4205.20.00	G420KR	355 119

Comparison list by RUEN

















RUEN reference	Parameter	Comparison refer.
VALEO >>		
4211.20.00	G420KR	355 100
4212.30.00	420/210GSZ	355 179
4222.20.00	GF420KR	355 141
4222.20.00	GF420KR	805 549
4224.20.00	GF420KR	805 649
4226.20.00	GF420KR	355 149
4231.30.00	420GSZ	355 139
4232.30.00	420GSZ	807 537
4234.20.00	GF420KR	805 549
4235.20.00	GF420KR	355 138
4235.30.00	420/210GS	807 542
4236.20.00	GF420KR	805 809
4244.20.00	GFX420KR	358 350
4244.30.00	420/210GSZ	355 153
4248.20.00	GFX420KR	355 150
4250.30.00	420WGSZ	806 363
4254.30.00	420GSZ	355 101
4257.20.00	GMF420K	355 178
4257.30.00	420GSZ	806 478
4258.30.00	420GSZ	806 012
4261.20.00	GMF420K	358 335
4261.30.00	420GSZ	807 518
4263.20.00	GMF420K	094 185
4263.20.00	GMF420K	805 726
4272.30.00	420WGSZ	806 179
4300.20.00	MFZ430	805 642
4300.90.01		805 028
4300.90.02		805 031
4300.90.02		805 064
4300.90.03		805 164
4300.90.04		805 030
4300.90.04		805 063
4300.90.05		805 062
4300.90.05		805 186
4300.90.06		805 228
4300.90.07		805 034
4300.90.09		805 450
4300.90.09		805 454
4300.90.10		805 220
4300.90.11		805 073
4300.90.11		805 453
4300.90.15		809 140
4300.90.15		839 139
4300.90.41		805 386
4300.90.51		827 052
4301.20.00	MFZ430	805 600
4301.20.00	MFZ430	805 724
4304.20.00	MFZ430	508 028
4304.20.00	MFZ430	805 711
4305.20.00	MFZ430	805 513
4305.20.00	MFZ430	805 831
4305.30.00	430W2GTZ	806 015
4305.30.00	430W2GTZ	806 190
4306.30.00	430WGTZ	806 449
4306.30.00	430WGTZ	807 507
4306.30.00	430WGTZ	807 575
4307.20.00	MFZ430	805 633
4311.20.00	MFZ430	805 785
4311.26.00	MFZ430	805 603
4311.30.00	430W2GTZ	806 024
4311.30.00	430W2GTZ	807 571
4312.30.00	430W2GTZ	807 508
4312.30.00	430W2GTZ	807 573
4313.20.00	MFZ430	805 632

RUEN reference	Parameter	Comparison refer.
4313.20.00	MFZ430	831 030
4318.30.00	430WGTZ	807 510
4318.60.00	MFZ430	805 771
4321.30.00	430 WGTZ	807 515
4326.30.00	430WGTZ	806 441
4326.30.00	430WGTZ	807 558
4327.30.00	430GTZ	806 200
4327.30.00	430GTZ	806 443
4327.30.00	430GTZ	807 558
4328.20.00	MFZ430	805 786
4328.20.00	MFZ430	805 787
4329.60.00	MFZ430	805 781
4332.60.00	MFZ430	805 798
4332.60.00	MFZ430	805 801
4333.30.00	430WGTZ	807 545
4334.30.00	430GTZ	807 503
4500.40.00	KZIZ - 3	806 507
4502.40.00	KZI - 1	279 431
5501.40.00	KZISZ - 3	806 535
6901.40.00	KZI - 3	358 297
6905.40.00	KZIS - 3	806 504
6908.40.00	KZ - 3	358 546
6908.40.00	KZ - 3	358 547
8401.40.00	KZI - 4,5	806 662
8500.40.00	KZI - 4,5	358 286
8505.40.00	KZI - 4,5	806 615
8509.40.00	KZI - 4,5	358 281
8511.40.00	KZI - 4,5	806 532
8514.40.00	KZI - 4,5	358 511
8520.40.00	KZI - 4,5	806 529
8900.40.00	KZI - 5	358 323
8901.40.00	KZI - 5	806 540
8905.40.00	KZIZ - 5	806 611
8916.40.00	KZIZ - 5	806 616
8918.40.00	KZISZ - 5	806 677
8919.40.00	KZISZ - 5	806 508
8932.40.00	KZISZ - 5	806 667
8933.40.00	KZISZ - 5	806 706
8934.40.00	KZISZ - 5	830 010
8937.40.00	KZISZ-5	806 675
8940.40.00	KZISZ-5	806 683
8941.40.00	KZISZ-5	830 001
9101.40.00	KZI - 5	830 007

Contents - Clutches for commercial vehicles





Vehicle list	1
ASKAM CHRYSLER (TÜRKİYE)	1
ASTRA	1
AVIA	6
BARKAS	6
BMC (TÜRKİYE)	6
DAF	7
DAF (TÜRKİYE)	40
DEMAG	41
ENASA	41
EVOBUS	41
FAUN	41
FIAT	44
FORD	45
FORD (TÜRKİYE)	48
IVECO	48
IVECO-FIAT (TÜRKİYE)	126
KAELBLE	126
KAMAZ	127
KAROSA	130
KRAUSS-MAFFEI AG	130
KRUPP	130
LIAZ	131
LIEBHERR	131
MAGIRUS-DEUTZ	132
MAN	149
MAN (TÜRKİYE)	278
MAZ	279
MERCEDES (TÜRKİYE)	280
MERCEDES-BENZ	282
OSTERREICHISCHE AUTOMOBILFABRIK (OAF)	463
OTOYOL (TÜRKİYE)	468
PERLINI	469
PEUGEOT	469
RENAULT	470
RENAULT (TÜRKİYE)	472
RENAULT TRUCKS	473
SCANIA	531
SCANIA (TÜRKİYE)	570
SISU	571
STEYR	571
TAM	580
TATRA	582
VOLVO	582
VOLVO (TÜRKİYE)	633
ZASTAVA	634
YaMZ	634
ZIL	635
Arithmetical List	637
Cross reference list	695
Comparison list by manufacturer	715
Comparison list by RUEN	729

Symbols

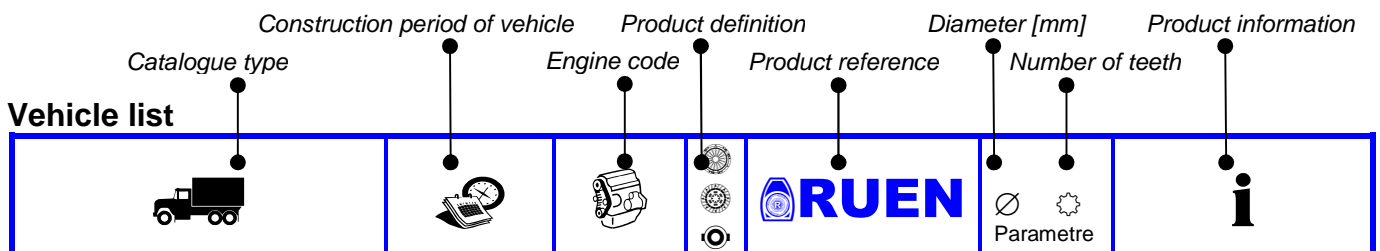
	Passenger cars
	Commercial vehicles
	Busses
	Tractors
	Clutch Kit
	Cover assembly
	Clutch Disc
	Release bearing
	Only available as kit
	Release bearing fitted to the cover assembly
	Optional design
	Without releaser
	Transmission side
	Engine side
	Heavy duty version
	In development

Catalogue layout



MERCEDES-BENZ						
OS 1831 - 1860	04.96 -					
1831 AK 1831 K	04.97 - 10.02 04.97 - 10.02	OM 541.920 OM 541.926 OM 541.941		4000.90.02   4012.10.00  4012.30.00  8922.40.00	400 18 MFZ2/400 400WGVZ KZISZ-5	- Equipment Var: SA50468204
<i>Vehicle type</i>	<i>Vehicle model</i>	<i>Vehicle manufacturer</i>	<i>Construction period</i>	<i>Product criteria</i>		

Measuring scale

- Profiles in inches

Mark	∅ d1 Mm	∅ d2 mm	b mm
5/8 "	13.7	16.1	2.50
7/8 "	19.1	22.2	3.45
1 "	20.6	25.8	3.93
1 1/8 "	23.4	28.9	4.45
1 1/4 "	25.8	32.1	4.93
1 3/8 "	28.7	35.2	5.43
1 1/2 "	30.7	38.4	5.89
1 5/8 "	33.4	41.3	6.40
1 3/4 "	36.0	44.5	6.88
2SAE "	41.1	50.8	7.88

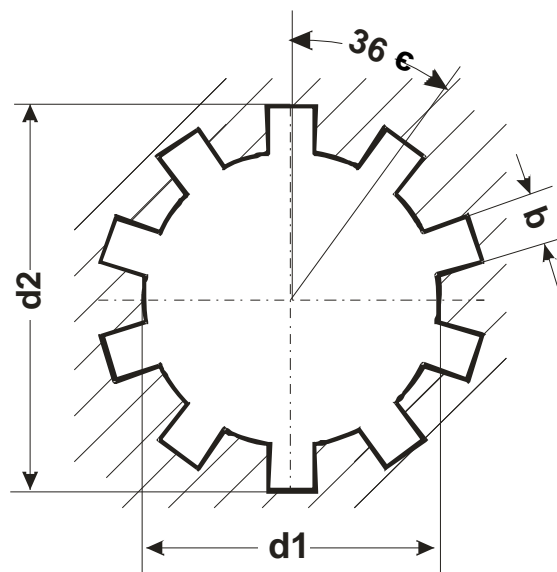

Übersetzung

Arithmetical list	Arithmetische Liste
Box	Kasten
Bus	Bus
Cab with engine	Triebkopf
Catalogue layout	Katalogaufbau
Catalogue type	Katalogtyp
Chassis no.	Fahrgestellnu.
Clutch Disc	Kupplungsscheibe
Clutch Kit	Kupplungssatz
Clutches for busses	Kupplungen für Busse
Clutches for commercial vehicles	Kupplungen für Nkw
Clutches for passenger cars	Kupplungen für Pkw
Clutches for tractors	Kupplungen für Traktoren
Comparison list by manufacturer	Vergleichsliste des Herstellers
Comparison list by RUEN	Vergleichsliste von RUEN
Comparison refer.	Vergleichsreferenz
Concrete Mixer	Betonmischer
Construction period of vehicle	Bauzeitraum des fahrzeugs
Contained in xxxx.10.00	In xxxx.10.00 enthalten
Contained in xxxx.60.00	In xxxx.60.00 enthalten
Contents	Inhalt
Convertible	Cabriolet
Coupe	Coupe
Cover assembly	Kupplungsdeckel
Cross reference list	Kreuzverweisliste
Diameter [mm]	Durchmesser [mm]
Diesel	Diesel
Dump Truck	Kipper
Engine code	Motornummer
Engine side	Motorseitig
Equipment Var	Ausgerüstet mit
Estate	Kombi
Flatbed/Chassis	Pritsche/Fahrgestell
For	Für
For PTO	Für nebenantrieb
From chassis no.	Ab fahrgestellnu.
From engine no.	Ab motornummer
From model year	Ab baujahr
From transmission no.	Ab getriebenummer
GBox	Getriebe
Hatchback	Schrägheck
Heavy duty version	Verstärkte ausführung
Hub profile	Nabenprofil
In development	In entwicklung
Loose clutch disc	Lose kupplungsscheibe
Manufacturer	Hersteller
Mark	Benennung
Measuring scale	Maßtabelle
Memo	Memo
MPV	Großraumlimousine
Not for chassis no.	Nicht für fahrgestellnummer
Number of teeth	Zähnezahl

Übersetzung

OEM reference	OEM Referenz
Off-Road Vehicle	Geländewagen
Only available as kit	Nur als satz lieferbar
Only install if the vehicle is equipped with an M-type clutch	Nur verbauen, wenn fahrzeug mit M-Kupplung ausgerüstet ist
Only install together	Nur zusammen verbauen
Optional design	Mahlweise
Page	Seite
Parameter	Parameter
Petrol	Benzin
Pickup	Pick-up
Platform/Chassis	Plattform/Fahrgestell
Product criteria	Produktkriterien
Product definition	Produktdefinition
Product description	Produktbeschreibung
Product information	Produktinformationen
Profiles in inches	Zollprofile
Reference	Referenz
Release bearing	Ausrücker
Release bearing fitted to the cover assembly	Ausrücker montiert mit kupplungsdeckel
RUEN - Products Catalogue 2018/19	RUEN - Produktkatalog 2018/19
RUEN reference	RUEN Referenz
Saloon	Stufenheck
See parts list for components	Siehe Teileliste
Special design	Sonderausführung
Special design	Sonderanfertigung
Symbols	Symbole
This part number includes one clutch disc	Diese artikelnummer enthält eine kupplungsscheibe
To chassis no.	Bis fahrgestellnu.
To engine no.	Bis motornummer
To model year	Bis baujahr
To transmission no.	Bis getriebenummer
Translation	Übersetzung
Transmission Number	Getriebenummer
Transmission side	Getriebeseitig
Transmission type	Getriebetyp
Truck Tractor	Sattelzugmaschine
Use release fork with cam	Ausrückgabel mit nocken verwenden
Use release fork with rollers	Ausrückgabel mit rollen verwenden
Utility truck	Kommunalfahrzeug
Van/Estate	Kasten/Kombi
Vehicle list	Fahrzeugliste
Vehicle manufacturer	Fahrzeughersteller
Vehicle model	Fahrzeugmodell
Vehicle type	Fahrzeugtyp
Vehicles with double disc clutch	Fahrzeuge mit zweiseibenkupplung
Vehicles with single clutch disc	Fahrzeuge mit einscheibenkupplung
Without releaser	Ohne ausrücker

Traduction

Arithmetical list	Liste arithmétique
Box	Boîte
Bus	Châssis autocar
Cab with engine	Châssis-cabine
Catalogue layout	Mise en page du catalogue
Catalogue type	Type de catalogue
Chassis no.	Châssis n°
Clutch Disc	Disque d'embrayage
Clutch Kit	Kit d'embrayage
Clutches for busses	Embrayages pour autobus
Clutches for commercial vehicles	Embrayages pour véhicules commerciaux
Clutches for passenger cars	Embrayages pour automobiles
Clutches for tractors	Embrayages pour tracteurs
Comparison list by manufacturer	Liste comparative par fabricant
Comparison list by RUEN	Liste comparative de RUEN
Comparison refer.	Référence de comparaison
Concrete Mixer	Bétonnière
Construction period of vehicle	Période de fabrication du véhicule
Contained in xxxx.10.00	Contenu dans xxxx.10.00
Contained in xxxx.60.00	Contenu dans xxxx.60.00
Contents	Table des matières
Convertible	Cabriolet
Coupe	Coupé
Cover assembly	Mécanisme d'embrayage
Cross reference list	Liste des références croisées
Diameter [mm]	Diamètre [mm]
Diesel	Diesel
Dump Truck	Camion benne
Engine code	Code moteur
Engine side	Côté moteur
Equipment Var	Equipé pour
Estate	Combi break/Véhicule industriel léger
Flatbed/Chassis	Camion Plate-forme/Châssis
For	Pour
For PTO	Pour commande auxiliaire
From chassis no.	A partir de châssis n°
From engine no.	A partir de moteur n°
From model year	A partir année de fabrication
From transmission no.	A partir de transmission n°
GBox	Boîte de vitesse
Hatchback	3/5 portes
Heavy duty version	Modèle renforcé
Hub profile	Cannelure de moyeu
In development	En développement
Loose clutch disc	Disque d'embrayage amovible
Manufacturer	Fabricant
Mark	Marque
Measuring scale	Echelle de mesure
Memo	Mémo
MPV	Monospace
Not for chassis no.	Ne convient pas au châssis n°
Number of teeth	Nombre de dentures

Traduction

OEM reference	OEM référence
Off-Road Vehicle	Véhicule tout terrain
Only available as kit	Uniquement disponible en kit
Only install if the vehicle is equipped with an M-type clutch	Installer uniquement si le véhicule est équipé du
Only install together	Installe uniquement ensemble
Optional design	Au choix
Page	Page
Parameter	Paramètre
Petrol	Essence
Pickup	Pick-up
Platform/Chassis	Plate-forme/Châssis
Product criteria	Critères du produit
Product definition	Définition du produit
Product description	Description du produit
Product information	Information sur le produit
Profiles in inches	Profile en pouces
Reference	Référence
Release bearing	Butée d'embrayage
Release bearing fitted to the cover assembly	Butée fixée sur le mécanisme d'embrayage
RUEN - Products Catalogue 2018/19	RUEN - Catalogue des produits 2018/19
RUEN reference	Référence RUEN
Saloon	Saloon
See parts list for components	Voir liste des pièces
Special design	Modèle spécial
Symbols	Symboles
This part number includes one clutch disc	Cette pièce comprend un disque d'embrayage
To chassis no.	Jusqu'à châssis n°
To engine no.	Jusqu'à moteur n°
To model year	Jusqu'à année de fabrication
To transmission no.	Jusqu'à transmission n°
Translation	Traduction
Transmission Number	Numéro de transmission
Transmission side	Côté transmission
Transmission type	Type de transmission
Truck Tractor	Camion-tracteur
Use release fork with cam	Utiliser fourche d'embrayage avec cames
Use release fork with rollers	Utiliser fourche d'embrayage avec rouleaux
Utility truck	Véhicule communal
Van/Estate	Van
Vehicle list	Liste véhicules
Vehicle manufacturer	Fabricant du véhicule
Vehicle model	Modèle de véhicule
Vehicle type	Type de véhicule
Vehicles with double disc clutch	Véhicule à embrayage bi-disque
Vehicles with single clutch disc	Véhicule à embrayage monodisque
Without releaser	Sans butée

Превод

Arithmetical list	Аритметичка листа
Box	Кутија
Bus	Автобус
Cab with engine	Погонска единица
Catalogue layout	Изглед на каталогот
Catalogue type	Тип на каталог
Chassis no.	Шасија бр.
Clutch Disc	Диск
Clutch Kit	Комплет спојница
Clutches for busses	Спојници за автобуси
Clutches for commercial vehicles	Спојници за комерцијални возила
Clutches for passenger cars	Спојници за патнички возила
Clutches for tractors	Спојници за трактори
Comparison list by manufacturer	Споредбена листа по производител
Comparison list by RUEN	Споредбена листа по RUEN
Comparison refer.	Споредбена ознака
Concrete Mixer	Мешалица за бетон
Construction period of vehicle	Период на изработка на возилото
Contained in xxxx.10.00	Содржано во xxxx.10.00
Contained in xxxx.60.00	Содржано во xxxx.60.00
Contents	Содржина
Convertible	Кабриолет
Coupe	Купе
Cover assembly	Нападно тело
Cross reference list	Вкрстена листа
Diameter [mm]	Диаметар [mm]
Diesel	Дизел
Dump Truck	Камион Кипер
Engine code	Број на мотор
Engine side	На страна на моторот
Equipment Var	Опремен со
Estate	Комбе
Flatbed/Chassis	Рамна шасија
For	За
For PTO	За РТО
From chassis no.	Од шасија
From engine no.	Од мотор број
From model year	До година на производство
From transmission no.	Од менувач број
GBox	Менувач
Hatchback	Задна врата
Heavy duty version	HD верзија
Hub profile	Хаб профил
In development	Во развој
Loose clutch disc	Неприцврстен диск
Manufacturer	Производител
Mark	Ознака
Measuring scale	Мерна скала
Memo	Белешки
MPV	Моноволумец
Not for chassis no.	Не за шасија број
Number of teeth	Број на заби

Превод

OEM reference	ОЕМ ознака
Off-Road Vehicle	Теренско возило
Only available as kit	Достапен само како комплет
Only install if the vehicle is equipped with an M-type clutch	Се инсталира само доколку возилото е опремено со М-тип на спојка
Only install together	Се инсталира само заедно
Optional design	По избор
Page	Страна
Parameter	Параметар
Petrol	Бензин
Pickup	Пикап
Platform/Chassis	Платформа/Шасија
Product criteria	Критериуми за производот
Product definition	Дефиниција на производот
Product description	Опис на производот
Product information	Информации за производот
Profiles in inches	Профили во инчи
Reference	Ознака
Release bearing	Исклучно лежиште
Release bearing fitted to the cover assembly	Лежиштето вградено со потисната плоча
RUEN - Products Catalogue 2018/19	RUEN - Каталог на производи 2018/19
RUEN reference	RUEN ознака
Saloon	Седан
See parts list for components	Да се види листа на делови за компонентите
Special design	Специјален дизајн
Symbols	Симболи
This part number includes one clutch disc	Оваа референца содржи еден диск
To chassis no.	До шасија
To engine no.	До мотор број
To model year	Од година на производство
To transmission no.	До менувач број
Translation	Превод
Transmission Number	Број на менувач
Transmission side	На страна на менувачот
Transmission type	Тип на менувач
Truck Tractor	Камион Влекач
Use release fork with cam	Користи исклучна вилушка со брег
Use release fork with rollers	Користи исклучна вилушка со валци
Utility truck	Комунално возило
Van/Estate	Комбе
Vehicle list	Листа по возила
Vehicle manufacturer	Производител на возила
Vehicle model	Модел на возило
Vehicle type	Тип на возило
Vehicles with double disc clutch	Возило со двоен диск
Vehicles with single clutch disc	Возило со единечен диск
Without releaser	Без лежиште

Prevod

Arithmetical list	Aritmetička lista
Box	Box
Bus	Autobus
Cab with engine	Kabina sa motorom
Catalogue layout	Izgled kataloga
Catalogue type	Tip kataloga
Chassis no.	Broj šasiije
Clutch Disc	Lamela
Clutch Kit	Set kvačila
Clutches for busses	Kvačila za autobuse
Clutches for commercial vehicles	Kvačila za komercijalna vozila
Clutches for passenger cars	Kvačila za putnička vozila
Clutches for tractors	Kvačila za traktore
Comparison list by manufacturer	Uporedna lista po proizvođaču
Comparison list by RUEN	Uporedna lista po RUENU
Comparison refer.	Uporedna oznaka
Concrete Mixer	Mešalica betona
Construction period of vehicle	Period izrade vozila
Contained in xxxx.10.00	Sadržano u xxxx.10.00
Contained in xxxx.60.00	Sadržano u xxxx.60.00
Contents	Sadržaj
Convertible	Kabriolet
Coupe	Kupe
Cover assembly	Korpa kvačila
Cross reference list	Ukrštena lista
Diameter [mm]	Dijametar [mm]
Diesel	Dizel
Dump Truck	Kamion-kiper
Engine code	Broj motora
Engine side	Na strani motora
Equipment Var	Opremljen sa
Estate	Estate
Flatbed/Chassis	Ravna šasija
For	Za
For PTO	Za pogon na dodatnu osovinu
From chassis no.	Od šasiije
From engine no.	Od broja motora
From model year	Od godine proizvodnje
From transmission no.	Od broja mjenjača
GBox	Menjač
Hatchback	Peta vrata
Heavy duty version	Ojačana verzija
Hub profile	Presek osovine
In development	U razvoju
Loose clutch disc	Nepričvršćena lamela
Manufacturer	Proizvođač
Mark	Oznaka
Measuring scale	Merna skala
Memo	Beleške
MPV	MPV
Not for chassis no.	Ne za broj šasiije
Number of teeth	Broj zuba

Prevod

OEM reference	OEM oznaka
Off-Road Vehicle	Terensko vozilo
Only available as kit	Dostupno samo kao set
Only install if the vehicle is equipped with an M-type clutch	Instalirati samo ukoliko je vozilo opremljeno sa kvačilom M-tipa
Only install together	Instalirati samo zajedno
Optional design	Po izboru
Page	Strana
Parameter	Parametar
Petrol	Benzin
Pickup	Pick up
Platform/Chassis	Platforma/šasija
Product criteria	Kriterijum proizvoda
Product definition	Definicija proizvoda
Product description	Opis proizvoda
Product information	Informacija o proizvodu
Profiles in inches	Profili u inčima
Reference	Oznaka
Release bearing	Isključni ležaj
Release bearing fitted to the cover assembly	Isključni ležaj ugrađen na korpu kvačila
RUEN - Products Catalogue 2018/19	RUEN - Katalog proizvoda 2018/19
RUEN reference	RUEN oznaka
Saloon	Saloon
See parts list for components	Vidi listu delova za komponente
Special design	Specijalni dizajn
Symbols	Simboli
This part number includes one clutch disc	Ova referenca sadrži jednu lamelu
To chassis no.	Do šasije
To engine no.	Do broja motora
To model year	Do godine proizvodnje
To transmission no.	Do broja mjenjača
Translation	Prevod
Transmission Number	Broj mjenjača
Transmission side	Na strani menjača
Transmission type	Tip mjenjača
Truck Tractor	Tegljac Traktor
Use release fork with cam	Koristi isključnu viljušku sa bregom
Use release fork with rollers	Koristi isključnu viljušku sa valjcima
Utility truck	Komunalno vozilo
Van/Estate	Van/Estate
Vehicle list	Lista vozila
Vehicle manufacturer	Proizvođač vozila
Vehicle model	Model vozila
Vehicle type	Tip vozila
Vehicles with double disc clutch	Vozilo sa duplim kvačilom
Vehicles with single clutch disc	Vozilo sa jednostrukim kvačilom
Without releaser	Bez isključnog ležaja

Перевод

Arithmetical list	Арифметический лист
Box	Коробка
Bus	Автобус
Cab with engine	Двигательная единица
Catalogue layout	Внешний вид каталога
Catalogue type	Тип каталога
Chassis no.	Код шасси
Clutch Disc	Ведомый диск сцепления
Clutch Kit	Комплект
Clutches for busses	Сцепления для автобусов
Clutches for commercial vehicles	Сцепления для грузовых автомобилей
Clutches for passenger cars	Сцепления для легковых автомобилей
Clutches for tractors	Сцепления для тракторов
Comparison list by manufacturer	Сопоставительный лист по производителям
Comparison list by RUEN	Сопоставительный лист по РУЕНе
Comparison refer.	Сопост. номер
Concrete Mixer	Бетономешалка
Construction period of vehicle	Срок изготовления автомобиля
Contained in xxxx.10.00	Входящий в состав xxxx.10.00
Contained in xxxx.60.00	Входящий в состав xxxx.60.00
Contents	Содержание
Convertible	Кабриолет
Coupe	Купе
Cover assembly	Нажимный диск сцепления
Cross reference list	Перекрестный ссылочный лист
Diameter [mm]	Диаметр [мм]
Diesel	Дизель
Dump Truck	Самосвал
Engine code	Код двигателя
Engine side	Со стороне двигателя
Equipment Var	Оборудован с
Estate	Фургон
Flatbed/Chassis	Шасси
For	Для
For PTO	Для ПТО
From chassis no.	От шасси но.
From engine no.	От кода двигателя но.
From model year	До года выпуска модели
From transmission no.	От КП но.
GBox	Передача
Hatchback	Задняя дверь
Heavy duty version	Версия для тяжелого режима работы
Hub profile	Профиль узла
In development	В развитие
Loose clutch disc	Незакрепленный диск
Manufacturer	Производитель
Mark	Знак
Measuring scale	Измерительная шкала
Memo	Записка
MPV	Лимузин
Not for chassis no.	Не соответствует для шасси но.
Number of teeth	Количество зубьев

Перевод

OEM reference	ОЕМ номер
Off-Road Vehicle	Автомобиль для бездорожья
Only available as kit	Доступный только в комплекте
Only install if the vehicle is equipped with an M-type clutch	Устанавливать только если автомобиль оборудован со сцеплением М-типа
Only install together	Устанавливать только совместно
Optional design	Произвольный выбор
Page	Страница
Parameter	Параметр
Petrol	Бензин
Pickup	Пикап
Platform/Chassis	Платформа/Шасси
Product criteria	Критерий продукта
Product definition	Дефиниция продукта
Product description	Описание продукта
Product information	Информации о продукте
Profiles in inches	Профили в дюймах
Reference	Ссылочный номер
Release bearing	Подшипник расцепителя
Release bearing fitted to the cover assembly	Расцепитель установлен на нажимном диске
RUEN - Products Catalogue 2018/19	РУЕН - Каталог продуктов 2018/19
RUEN reference	Номер РУЕНа
Saloon	Седан
See parts list for components	Посмотри список составных частей
Special design	Специальный дизайн
Symbols	Символы
This part number includes one clutch disc	Настоящий ссылочный номер содержит только один диск
To chassis no.	По шасси но.
To engine no.	По коду двигателя но.
To model year	От года выпуска модели
To transmission no.	По КП но.
Translation	Перевод
Transmission Number	Код коробки передачи
Transmission side	Со стороне коробки передачи
Transmission type	Тип КП
Truck Tractor	Трактор-тягач
Use release fork with cam	Пользуется выкл. свернутой вилкой
Use release fork with rollers	Пользуется выкл. вилкой с роликами
Utility truck	Коммунальный автомобиль
Van/Estate	Автофургон
Vehicle list	Список автомобилей
Vehicle manufacturer	Производитель автомобилей
Vehicle model	Модель автомобиля
Vehicle type	Тип автомобиля
Vehicles with double disc clutch	Автомобиль с удвоенным диском
Vehicles with single clutch disc	Автомобиль с единичным диском
Without releaser	Без расцепителя

Çeviri

Arithmetical list	Aritmetik Liste
Box	Vites Kutusu
Bus	Otobüs
Cab with engine	Motorlu Kabin
Catalogue layout	Katalog Düzeni
Catalogue type	Katalog Tipi
Chassis no.	Şasi No.
Clutch Disc	Debriyaj diski
Clutch Kit	Debriyaj Seti
Clutches for busses	Otobüsler İçin Debriyajlar
Clutches for commercial vehicles	Ticari Araçlar İçin Debriyajlar
Clutches for passenger cars	Binek Araçları için Debriyajlar
Clutches for tractors	Traktörler İçin Debriyajlar
Comparison list by manufacturer	OEM Geçiş Listesi
Comparison list by RUEN	Tirsan Geçiş Listesi
Comparison refer.	Karşılaştırma Refer.
Concrete Mixer	Beton Mikseri
Construction period of vehicle	Araç Üretim Tarih Aralığı
Contained in xxxx.10.00	xxxx.10.00 içinde bulunan
Contained in xxxx.60.00	xxxx.60.00 içinde bulunan
Contents	İçerik
Convertible	Cabriolet
Coupe	Coupe
Cover assembly	Debriyaj Baskısı
Cross reference list	Çapraz Geçiş Listesi
Diameter [mm]	Çap [mm]
Diesel	Dizel
Dump Truck	Damperli Kamyon
Engine code	Motor Kodu
Engine side	Motor Tarafı
Equipment Var	Ekipman var
Estate	Arazi Taşıtı
Flatbed/Chassis	Düz/Şasi
For	İçin
For PTO	PTO İçin
From chassis no.	Şasi No' dan İtibaren
From engine no.	Motor No' dan İtibaren
From model year	Model Yılından İtibaren
From transmission no.	Şanzıman No'dan itibaren
GBox	Vites Kutusu
Hatchback	Hatchback
Heavy duty version	Ağır Hizmet Tipi
Hub profile	Göbek Profili
In development	Geliştirilmekte
Loose clutch disc	Hareketli Debriyaj Diski
Manufacturer	OEM
Mark	Markalama
Measuring scale	Ölçü Tablosu
Memo	Hatırlatma
MPV	MPV
Not for chassis no.	Şasi No'su İçin Değil
Number of teeth	Diş Sayısı

Çeviri

OEM reference	OEM Referansı
Off-Road Vehicle	OFF Road Araç
Only available as kit	Sadece kit olarak kullanılabilir
Only install if the vehicle is equipped with an M-type clutch	Yalnızca M-tipi Debriyaj ile Donatılmış araç ise
Only install together	Sadece Birlikte Kullanılabilir
Optional design	İsteğe Bağlı Tasarım
Page	Sayfa
Parameter	Parametre
Petrol	Benzinli
Pickup	Pickup
Platform/Chassis	Platform/Şasi
Product criteria	Ürün Kriterleri
Product definition	Ürün Tanımı
Product description	Ürün Açıklaması
Product information	Ürün Bilgisi
Profiles in inches	Inch Ölçü Profilleri
Reference	Referans
Release bearing	Debriyaj Rulmanı
Release bearing fitted to the cover assembly	Debriyaj Rulmanı Baskıya Montajlı
RUEN - Products Catalogue 2018/19	RUEN - Debriyaj Ürün Kataloğu 2018/19
RUEN reference	Tirsan Referansı
Saloon	Sedan
See parts list for components	Bileşenleri için parça listesine bakınız
Special design	Özel Tasarım
Symbols	Semboller
This part number includes one clutch disc	Bu Parça No Bir Debriyaj Diski İçindir
To chassis no.	Şasi No.na kadar
To engine no.	Motor No'suna Kadar
To model year	Model Yılı
To transmission no.	Şanzıman No'suna Kadar
Translation	Çeviri
Transmission Number	Şanzıman Numarası
Transmission side	Şanzıman Tarafı
Transmission type	Şanzıman Tipi
Truck Tractor	Çekici
Use release fork with cam	Kam ile Çalışan Serbest Çatal Kullanımı
Use release fork with rollers	Makara ile Çalışan Serbest Çatal Kullanımı
Utility truck	Çok Amaçlı Kamyon
Van/Estate	Van/Kasa
Vehicle list	Araç Listesi
Vehicle manufacturer	Araç Üreticisi
Vehicle model	Araç Modeli
Vehicle type	Araç Tipi
Vehicles with double disc clutch	Çift Debriyaj Diskli Araçlar
Vehicles with single clutch disc	Tek Debriyaj Diskli Araçlar
Without releaser	Geri Getirici Olmadan