











Vehicle list

					
---	---	---	--	---	---

BARKAS





B 1000 Bus (KO)

04.67 - 01.76

1.0	04.67 - 12.91	1.0		1800.90.02  1801.20.00  1801.30.00  3212.40.00	180 24 T180120 180DE2R KZI - 0
-----	---------------	-----	---	---	--







B 1000 Bus (KB)

01.76 -

1.0	01.76 - 12.91	353-1/B1000		1800.90.02  1801.20.00  1801.30.00  3212.40.00	180 24 T180120 180DE2R KZI - 0
-----	---------------	-------------	---	---	--

BMC (TÜRKIYE)















BELDE / PROBUS SERISI

PROBUS 215 - 850	01.01 - 01.08			3574.20.00	350 14" MF 350
BELDE 214.17B				3868.20.00	380 15" GM380
				3884.30.00	380 10 15" 380GSZ
BELDE 220.17C				4300.20.00	430 MFZ430
				4316.30.00	430 10 430WGTZ
				8935.40.00	KZISZ - 5







BOVA

Futura

09.84 -





















FHD 10-340 FHD 12-340				4256.20.00	420 GMF420K
				4244.30.00	420 10 420/210GSZ
				9101.40.00	KZI - 5
FHD 12-370		WS 268 M		4256.20.00	420 GMF420K - GBox: ZF S6-1600
				4259.30.00	420 10 420GSZ - GBox: ZF S6-1600
				9101.40.00	KZI - 5 - GBox: ZF S6-1600
FHD 14-430 XE Magnum FHD 15-430 XE Magnum				4303.20.00	430 MFZ430 - GBox: ZF 8S-180
				4306.30.00	430 10 430WGTZ - GBox: ZF 8S-180
				8935.40.00	KZISZ - 5 - GBox: ZF 8S-180
FHX 12-370				4301.20.00	430 MFZ430 - GBox: ZF S8-180
				8916.40.00	KZIZ - 5 - GBox: ZF S8-180
FLD 12-300				4257.20.00	420 GMF420K
				4244.30.00	420 10 420/210GSZ
				9101.40.00	KZI - 5

Vehicle list

					
---	---	---	--	---	---



BOVA

Futura 09.84 -







FUTURA				3800.90.52  3878.20.00  3897.30.00  7951.40.00	380 10 GMF380 380GSZ KZIS - 4	- To chassis no.: 3412
				4200.90.22  4248.20.00  4244.30.00  8514.40.00	420 10 GFX420KR 420/210GSZ KZI - 4,5	- To chassis no.: 3597
				4257.20.00	420 GMF420K	- From chassis no.: 3598
				4244.30.00	420 10 420/210GSZ	- From chassis no.: 3598
				8505.40.00	KZI - 4,5	- From chassis no.: 3598
				4254.20.00	420 GF420X	
				4235.20.00	420 GF420KR	
				4258.30.00	420 10 420GSZ	
				4296.20.00	420 GF420	
				4257.30.00	420 10 420GSZ	
				8500.40.00	KZI - 4,5	
				4341.20.00	430 MFZ430	
				4306.30.00	430 10 430WGTZ	
				4256.20.00	420 GMF420K	
				4259.30.00	420 10 420GSZ	

DAF





Bus

SB 4000				4303.20.00	430 MFZ430	
				4306.30.00	430 10 430WGTZ	







MB

MB 200 DKTL MB 2000 DKTL				4205.20.00	420 G420KR	
				4208.30.00	420 10 420GS	
				8514.40.00	KZI - 4,5	
MB 230				4257.20.00	420 GMF420K	
				4250.30.00	420 10 420WGSZ	
				8514.40.00	KZI - 4,5	

SB





SB 1600 DF SB 1600 DS SB 1600 DT				3521.20.00	350 GF350KR	- GBox: AK/S 5-35-2
				3563.30.00	350 10 350GSZ	- GBox: AK/S 5-35-2
SB 1602 DF SB 1602 DS				3521.20.00	350 GF350KR	
				3563.30.00	350 10 350GSZ	

Vehicle list

					
---	---	---	--	---	---































DAF

SB







SB 1602 DT SB 1605		3829.20.00	380 GF380KR	
		3852.30.00	380 10 380GS	
SB 3000		4257.20.00	420 GMF420K	
		4250.30.00	420 10 420WGSZ	
		8514.40.00	KZI - 4,5	

DRÖGMÖLLER

280 - 440







E 280 E 290 E 300 E 310 E 320		4200.90.17	420 10 GF420KR	- GBox: ZF
		4235.20.00	420GSZ	
		4258.30.00	KZI - 4,5	
		8500.40.00	KZI - 4,5	
		4254.20.00	420 GF420X	- GBox: ZF
		4272.30.00	420 10 420WGSZ	- GBox: ZF
E 330		8500.40.00	KZI - 4,5	- GBox: ZF
		4200.90.17	420 10 GF420KR	
		4235.20.00	420GSZ	
		4258.30.00	KZI - 4,5	
		8500.40.00	KZI - 4,5	
		4254.20.00	420 GF420X	
		4272.30.00	420 10 420WGSZ	
		8500.40.00	KZI - 4,5	
		3882.10.00	380 GF2/380	- This part number includes one clutch disc
		3855.30.00	380 10 380GS	- Loose clutch disc
E 420 E 430 E 440		3882.20.00	380 GF2/380	- Contained in xxxx.10.00
		3882.50.00	380 GF2/380	- Contained in xxxx.10.00
		3883.30.00	380 10 380GSZ	- Contained in xxxx.10.00
		4200.90.17	420 10 GF420KR	
		4235.20.00	420GSZ	
		4258.30.00	KZI - 4,5	
		8500.40.00	KZI - 4,5	
		4254.20.00	420 GF420X	
	4272.30.00	420 10 420WGSZ		
	8500.40.00	KZI - 4,5		
	3857.10.00	380 GF2/380	- This part number includes one clutch disc	
	3892.30.00	380 10 380GSZ	- Loose clutch disc - Contained in xxxx.10.00	
	8520.40.00	KZI - 4,5		
	3857.20.00	380 G380KR	- Contained in xxxx.10.00	
	3857.50.00	380 GF2/380	- Contained in xxxx.10.00	

Vehicle list

					
---	---	---	--	---	---





ENASA

5036 - 6420









5036			 4264.20.00	420 GFM420K	
			 4291.30.00	420 10 420GSZ	
5117			 4264.20.00	420 GFM420K	
			 3802.30.00	380 10 380GSZ	
5123			 4264.20.00	420 GFM420K	
			 4291.30.00	420 10 420GSZ	

EVOBUS





NF 315...

NF 315			 4300.90.57	430 10 MFZ430	
			 4304.20.00	430WGTZ	
			 4316.30.00	KZISZ - 5	
			 8935.40.00		





S 12 - S 15

S 12			 3807.20.00	380 G380KR	
			 7951.40.00	KZIS - 4	
S 12 L			 3804.20.00	380 G380KR	
			 7951.40.00	KZIS - 4	
S 14			 3807.20.00	380 G380KR	- GBox: S 6-70-3
			 7951.40.00	KZIS - 4	- GBox: S 6-70-3
S 15			 3807.20.00	380 G380KR	- GBox: S 6-70-3
			 7951.40.00	KZIS - 4	- GBox: S 6-70-3
			 3810.20.00	380 G380KR	- GBox: S 6-80



S 80...

S 80			 3506.20.00	350 G350	- GBox: S 8-45/2
			 7951.40.00	KZIS - 4	- GBox: S 8-45/2 - GBox: S 8-35/2
			 3122.20.00	310 GFX310	
			 3126.30.00	310 10 310GSBL	

S 100...

S 100	01.78 -		 3506.20.00	350 G350	- GBox: ZF S 6-60
			 7951.40.00	KZIS - 4	- GBox: ZF S 6-60
S 100			 3506.20.00	350 G350	- GBox: S 8-45/2
			 7951.40.00	KZIS - 4	- GBox: S 8-45/2

S 110...

S 110	01.78 -		 3506.20.00	350 G350	- GBox: ZF S 6-60
			 7951.40.00	KZIS - 4	

Vehicle list

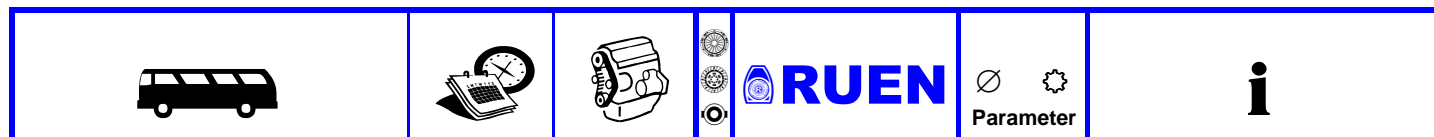

EVOBUS

S 110...

S 110			3506.20.00	350 G350	- GBox: S 8-35-2 - GBox: S 8-45/2
			7951.40.00	KZIS - 4	- GBox: S 8-35-2 - GBox: S 8-45/2

S 120...

S 120	01.78 -		3506.20.00	350 G350	- GBox: ZF S 6-60
			7951.40.00	KZIS - 4	- GBox: ZF S 6-60
S 120			3506.20.00	350 G350	- GBox: S 8-45/2
			7951.40.00	KZIS - 4	- GBox: S 8-45/2 - GBox: S 6-80
			3807.20.00	380 G380KR	- GBox: S 8-45/2
			3810.20.00	380 G380KR	- GBox: S 6-80
S 125			3804.20.00	380 G380KR	
			7951.40.00	KZIS - 4	- GBox: S 4-60
			3807.20.00	380 G380KR	- GBox: S 4-60
S 128 DT 90			4341.20.00	430 MFZ430	- GBox: ZF S8-180
			4306.30.00	430 10 430WGTZ	- GBox: S 8-180

S 130...

S 130	01.67 -		3807.20.00	380 G380KR	- GBox: S 6-70-3
			7951.40.00	KZIS - 4	- GBox: S 6-70-3
			3810.20.00	380 G380KR	- GBox: S 6-80
S 130	01.78 -		3506.20.00	350 G350	- GBox: ZF S 6-60
			7951.40.00	KZIS - 4	- GBox: ZF S 6-60
S 130			3807.20.00	380 G380KR	- GBox: S 8-45/2
			7951.40.00	KZIS - 4	- GBox: S 8-45/2 - GBox: S 6-80 - GBox: S 6-80 + GV 80
			3810.20.00	380 G380KR	- GBox: S 6-80
			3506.20.00	350 G350	
			4225.20.00	420 GF420KR	
			4235.20.00	420 GF420KR	
			4250.20.00	420 GFX420KR	
S 130 S			3821.20.00	380 GF380KR	- GBox: S 6-60 + S 4-90
			3888.30.00	380 10 380WGSZ	- GBox: S 6-60 + S 4-90

S 140...

S 140	01.78 -		3506.20.00	350 G350	- GBox: ZF S 6-60
			7951.40.00	KZIS - 4	- GBox: ZF S 6-60

Vehicle list

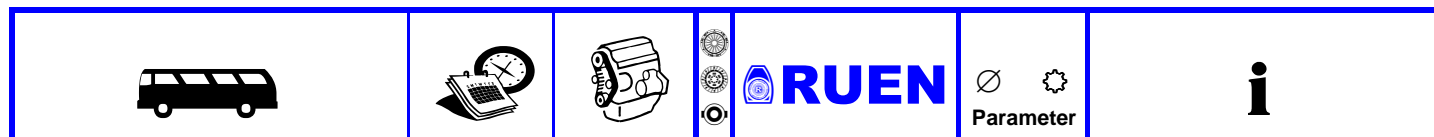

EOBUS

S 140...

S 140			3807.20.00	380 G380KR	- GBox: S 8-45/2
			7951.40.00	KZIS - 4	- GBox: S 6-80 - GBox: S 8-45/2 - GBox: ZF S 6-60 - GBox: S 6-80 + GV 80
			3810.20.00	380 G380KR	- GBox: S 6-80 - GBox: S 6-80 + GV 80
S 140, ES			4225.20.00	420 GF420KR	
			4235.20.00	420 GF420KR	
			4250.30.00	420 10 420WGSZ	
S 140 ES			4225.20.00	420 GF420KR	- GBox: S 6-80
			4235.20.00	420 GF420KR	- GBox: S 6-80
			4250.30.00	420 10 420WGSZ	- GBox: S 6-80
			3821.20.00	380 GF380KR	- GBox: S 6-80 + S 4-90
			3888.30.00	380 10 380WGSZ	- GBox: S 6-80 + S 4-90







S 150...

S 150	01.67 -		3807.20.00	380 G380KR	- GBox: S 6-70-3
			7951.40.00	KZIS - 4	- GBox: S 6-70-3
S 150	01.78 -		3506.20.00	350 G350	- GBox: ZF S 6-60
			7951.40.00	KZIS - 4	- GBox: ZF S 6-60
S 150			3807.20.00	380 G380KR	- GBox: S 8-45/2
			7951.40.00	KZIS - 4	- GBox: S 8-45/2 - GBox: S 6-80 - GBox: S 6-80 + GV 80
			3810.20.00	380 G380KR	- GBox: S 6-80
			3506.20.00	350 G350	- GBox: S 8-45/2

S 200...





S 200			4244.20.00	420 GFX420KR	
			4282.30.00	420 10 420WGVZ	
S 200 Fahrzeug -20			4225.20.00	420 GF420KR	
			4235.20.00	420 GF420KR	
			4231.30.00	420 10 420GSZ	
			8514.40.00	KZI - 4,5	
S 200 Fahrzeug 21-			4225.20.00	420 GF420KR	
			4235.20.00	420 GF420KR	
			4258.30.00	420 10 420GSZ	
S 208			3300.20.00	330 GFM330	- GBox: S 6-65
			3306.30.00	330 10 330GSZ	- GBox: S 6-65

Vehicle list



























					
---	---	---	--	---	---

EOBUS

S 200...

S 208 H		3300.20.00	330 GFM330	- GBox: S 6-65
		3308.30.00	330 10 330GSZ	- GBox: S 6-65
S 209 , H		3821.20.00	380 GF380KR	- GBox: S 6-65
		3888.30.00	380 10 380WGSZ	- GBox: S 6-65

S 210...

S 210 H		3300.20.00	330 GFM330	- GBox: S 6-65
		3306.30.00	330 10 330GSZ	- GBox: S 6-65
S 210 H/HD		4225.20.00	420 GF420KR	- GBox: S 6-90
		4235.20.00	420 GF420KR	- GBox: S 6-90
		4250.30.00	420 10 420WGSZ	- GBox: S 6-90
S 211 , H S 214		3821.20.00	380 GF380KR	- GBox: S 6-65
		3888.30.00	380 10 380WGSZ	- GBox: S 6-65
S 211 H		3821.20.00	380 GF380KR	- GBox: S 6-65
		3888.30.00	380 10 380WGSZ	- GBox: S 6-65
S 211 H/HD S 213 H/HD, RL		4225.20.00	420 GF420KR	- GBox: S 6-90
		4235.20.00	420 GF420KR	- GBox: S 6-90
		4250.30.00	420 10 420WGSZ	- GBox: S 6-90
S 212		3821.20.00	380 GF380KR	- GBox: S 6-65 - GBox: S 6-80
		3888.30.00	380 10 380WGSZ	- GBox: S 6-65 - GBox: S 6-80
		4225.20.00	420 GF420KR	- GBox: S 6-90
		4235.20.00	420 GF420KR	- GBox: S 6-90
		4250.30.00	420 10 420WGSZ	- GBox: S 6-90
S 213 S 215		3821.20.00	380 GF380KR	- GBox: S 6-65 - GBox: S 6-80
		3888.30.00	380 10 380WGSZ	- GBox: S 6-65 - GBox: S 6-80
S 213 H/HD S 215 H/HD		4244.20.00	420 GFX420KR	- GBox: S 4-120GP, S6-150C
		4250.30.00	420 10 420WGSZ	- GBox: S 4-120GP, S6-150C
S 213 HD, HR		4225.20.00	420 GF420KR	- GBox: S 6-90
		4235.20.00	420 GF420KR	- GBox: S 6-90
		4250.20.00	420 GFX420KR	- GBox: S 6-90
S 214 HD		4244.20.00	420 GFX420KR	- GBox: S 6-150C
		4281.30.00	420 10 420WGVZ	- GBox: S 6-150C

Vehicle list

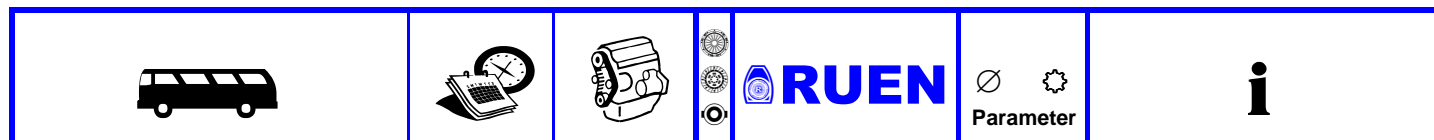







EOBUS

S 210...









S 215 , UL		4225.20.00	420 GF420KR	- GBox: S 6-90,S6-150C
		4235.20.00	420 GF420KR	- GBox: S 6-90,S6-150C
		4250.30.00	420 10 420WGSZ	- GBox: S 6-90,S6-150C
S 215 H/HD, RL		4225.20.00	420 GF420KR	- GBox: S 6-90
		4235.20.00	420 GF420KR	- GBox: S 6-90
		4250.30.00	420 10 420WGSZ	- GBox: S 6-90
S 215 HD		4244.20.00	420 GFX420KR	- GBox: S 6-150C - GBox: S 8-180
		4281.30.00	420 10 420WGVZ	- GBox: S 6-150C
		4250.30.00	420 10 420WGSZ	- GBox: S 6-150C
		4282.30.00	420 10 420WGVZ	- GBox: S 8-180
S 215 HD, HR		4304.20.00	430 MFZ430	- GBox: S 6-85
		4316.30.00	430 10 430WGTZ	- GBox: S 6-85
		8905.40.00	KZIZ - 5	- GBox: S 6-85
		4225.20.00	420 GF420KR	- GBox: S 6-90
		4235.20.00	420 GF420KR	- GBox: S 6-90
		4250.20.00	420 GFX420KR	- GBox: S 6-90
S 215 HR		4301.20.00	430 MFZ430	- GBox: S 8-180
		4306.30.00	430 10 430WGTZ	- GBox: S 8-180
S 215 RL		4307.20.00	430 MFZ430	- GBox: S 6-85
		4316.30.00	430 10 430WGTZ	- GBox: S 6-85
		8905.40.00	KZIZ - 5	- GBox: S 6-85
S 215 UL		4245.20.00	420 GFX420KR	- GBox: S 6-85
		4281.30.00	420 10 420WGVZ	- GBox: S 6-85
		4225.20.00	420 GF420KR	- GBox: S 6-85
		4235.20.00	420 GF420KR	- GBox: S 6-85
		4250.20.00	420 GFX420KR	- GBox: S 6-85
S 215 UL/SL		4225.20.00	420 GF420KR	- GBox: S 4-90, S5-80 - GBox: S 6-80, S6-150C
		4235.20.00	420 GF420KR	- GBox: S 4-90, S5-80 - GBox: S 6-80, S6-150C
		4250.30.00	420 10 420WGSZ	- GBox: S 4-90, S5-80 - GBox: S 6-80, S6-150C

Vehicle list













					
---	---	---	--	---	---

EOBUS



S 210...

S 216 HDS		4244.20.00	420 GFX420KR	- GBox: S6-150C - GBox: S 4-120GP, S 6-150C - GBox: S 8-180
		4281.30.00	420 10 420WGVZ	- GBox: S6-150C
		4250.20.00	420 GFX420KR	- GBox: S 4-120GP, S 6-150C
		4282.30.00	420 10 420WGVZ	- GBox: S 8-180
		3857.10.00	380 GF2/380	- GBox: S 4-150GP, S 6-150C - This part number includes one clutch disc
		3892.30.00	380 10 380GSZ	- GBox: S 4-150GP, S 6-150C - Loose clutch disc
		8520.40.00	KZI - 4,5	- GBox: S 8-180
		3857.20.00	380 G380KR	- GBox: S 4-150GP, S 6-150C
		3857.50.00	380 GF2/380	- GBox: S 4-150GP, S 6-150C







S 220...

S 221 UL		4225.20.00	420 GF420KR	
		4235.20.00	420 GF420KR	
		4250.30.00	420 10 420WGSZ	
S 228 DT		3857.10.00	380 GF2/380	- GBox: S 4-150GP, S 6-150C - This part number includes one clutch disc
		3892.30.00	380 10 380GSZ	- GBox: S 4-150GP, S 6-150C - Loose clutch disc
		8520.40.00	KZI - 4,5	- GBox: S 4-150GP, S 6-150C
		3857.20.00	380 G380KR	- GBox: S 4-150GP, S 6-150C
		3857.50.00	380 GF2/380	- GBox: S 4-150GP, S 6-150C
		4304.20.00	430 MFZ430	- GBox: S 8-180
		4306.30.00	430 10 430WGTZ	- GBox: S 8-180
		8935.40.00	KZISZ - 5	- GBox: S 8-180
		4021.30.00	400 10 400GVZ	- GBox: S 8-180 - Loose clutch disc
		4020.30.00	400 10 400GVZ	- GBox: S 8-180



























S 309...

S 309		4305.20.00	430 MFZ430	
		4316.30.00	430 10 430WGTZ	







Vehicle list

					
---	---	---	--	---	---

EOBUS



















S 310...					
S 312 HD, HDH		4305.20.00	430 MFZ430		
		4316.30.00	430 10 430WGTZ		
		4301.20.00	430 MFZ430		
		4306.30.00	430 10 430WGTZ		
		4225.20.00	420 GF420KR		
		4250.30.00	420 10 420WGSZ		
		43460.30.00	430 10 430WGTZ		- Engine code: OM 441LA
S 315		4225.20.00	420 GF420KR		
		4250.30.00	420 10 420WGSZ		
S 315 GT		4300.90.58	430 10 MFZ430		
		4307.20.00	430WGTZ		
		4346.30.00	KZISZ - 5		
		43460.30.00	430 10 430WGTZ		- Engine code: OM 441LA
		4300.90.400	430 10 MFZ430		- Engine code: OM 442LA
S 315 GT-HD		4307.20.00	430 MFZ430		- GBox: ZF S6-85 - GBox: ZF S6-150 - GBox: ZF S6-180 - GBox: ZF S6-1600 - GBox: GO 4
		4316.30.00	430 10 430WGTZ		- GBox: ZF S6-85
		4306.30.00	430 10 430WGTZ		- GBox: ZF S6-150 - GBox: ZF S6-180 - GBox: ZF S6-1600 - GBox: GO 4
		8935.40.00	KZISZ - 5		- GBox: ZF S6-85 - GBox: ZF S6-150 - GBox: ZF S6-180 - GBox: ZF S6-1600
		8928.40.00	KZIZ - 5		- GBox: GO 4
		4305.20.00	430 MFZ430		
S 315 HD, HDH		4316.30.00	430 10 430WGTZ		
		4301.20.00	430 MFZ430		
		4306.30.00	430 10 430WGTZ		
		4307.20.00	430 MFZ430		
		8935.40.00	KZISZ - 5		
		43460.30.00	430 10 430WGTZ		- Engine code: OM 441LA
		4305.20.00	430 MFZ430		

Vehicle list



					
---	---	---	--	---	---

EVOBUS



S 310...

S 315 UL			 4300.90.57	430 10	
			 4304.20.00	MFZ430	
			 4316.30.00	430WGTZ	
			 8935.40.00	KZISZ - 5	
S 316 HDS S 317 HDH			 4307.20.00	430	
				MFZ430	
			 4306.30.00	430 10	
				430WGTZ	
S 319 NF			 8935.40.00	KZISZ - 5	
			 4301.20.00	430	
				MFZ430	
			 4306.30.00	430 10	
	430WGTZ	- Engine code: OM 441LA			
S 315 NF S 317 ÜL S 319 UL			 4307.20.00	430	
				MFZ430	
			 4316.30.00	430 10	
				430WGTZ	- GBox: ZF 6S-85
		 4306.30.00	430 10		
			430WGTZ	- GBox: S6-1600/S6-150 - GBox: S8-180	
		 8935.40.00	KZISZ - 5		
S 315 NF S 317 ÜL S 319 UL			 4300.90.180 	430 10	
				MFZ430E	- Engine code: OM457HLA
			 43100.20.00	430WGTZ	- Only install together
			 4346.30.00	430WGTZ	
		 8939.40.00	KZISZ - 5		





S 320...

S 328 DT			 4021.30.00	400 10	
				400GVZ	- GBox: S 8-180 - Loose clutch disc
			 8935.40.00	KZISZ - 5	- GBox: S 8-180
		 4020.30.00	400 10		
			400GVZ	- GBox: S 8-180	

SG 175...

SG 175			 3804.20.00	380	
				G380KR	
		 7951.40.00	KZIS - 4		



SG 180...

SG 180			 4225.20.00	420	
				GF420KR	- GBox: S 6-80
			 4235.20.00	420	
				GF420KR	- GBox: S 6-80
			 4250.20.00	420	
		GFX420KR	- GBox: S 6-80		
		 3821.20.00	380		
			GF380KR	- GBox: S 6-80 + S 4-90	
		 3888.30.00	380 10		
			380WGSZ	- GBox: S 6-80 + S 4-90	







FIAT

DUCATO Panorama (280_)

07.82 - 08.90





1.8	07.82 - 12.88	XM7T	 2150.90.18	215 21	
				CP215	- To model year: 05.1985
			 2185.20.00	215CE	
			 3211.40.00	KZIS - 0	

Vehicle list

					
---	---	---	--	---	---







FIAT

DUCATO Panorama (280_) 07.82 - 08.90















2.0	07.82 - 05.85	XN 1T		2150.90.18  2185.20.00  2178.30.00  3211.40.00	215 21 CP215 215CE KZIS - 0	
-----	---------------	-------	---	---	---	--

FORD









TRANSIT Bus (V_) 11.77 - 10.86

1.6 (VAS, VLS, VZS)	12.77 - 10.86	4RB		2150.90.10  2171.20.00  2172.30.00  3206.40.00	215 23 MF215K 215D KZIS - 1	- From model year: 01/1978 - Engine code: OHC - GBox: F-Typ
				2172.30.00	215 23 215D	- From model year: 01/1978 - Engine code: OHC - GBox: F-Typ
				3206.40.00	KZIS - 1	- From model year: 01/1978 - Engine code: OHC - GBox: F-Typ
2.9 i V6	04.89 - 05.92			3205.40.00	KZIS - 0	- GBox: MT75





TRANSIT Bus (T_) 10.85 - 09.92

1.6 (TBL, TES)	12.85 - 01.89	LAT		2150.90.10  2171.20.00  2172.30.00  3206.40.00	215 23 MF215K 215D KZIS - 1	- GBox: F-Typ
2.5 D (TBS, TCL, TCS, TEL, TES)	12.85 - 01.89	4AB		2400.90.06  2403.20.00  2413.30.00  3205.40.00	242 23 MF240 240TD KZIS - 0	- From model year: 10.1988
2.5 D (TBS, TEL, TES)	09.88 - 09.92	4AB 4BA 4CA		2400.90.06  2403.20.00  2413.30.00  3205.40.00	242 23 MF240 240TD KZIS - 0	
2.0 (TBS, TCL, TCS, TEL, TES)	11.85 - 09.92	N6T		3205.40.00	KZIS - 0	- GBox: MT75
2.0 Cat (TBS, TCL, TCS)	12.85 - 09.92	NAT NAV		2413.30.00	240 23 240TD	- To model year: 07/1991 - GBox: MT75







TRANSIT Bus (E_) 01.91 - 09.94

2.5 DI (EBS, EDS, EDL, ESS, EUS)	08.91 - 07.94	4BC		2400.90.06  2403.20.00  2413.30.00  3205.40.00	242 23 MF240 240TD KZIS - 0	
2.5 DI (EBS, EDS, EGL, ESS, EUS)	09.91 - 07.94	4CC 4DA 4FA				
2.5 TD (EBS, EBL, ECL, EDS, EDL, ESS, EUS)	10.92 - 07.94	4EA		2400.90.06  2403.20.00  2413.30.00  3205.40.00	242 23 MF240 240TD KZIS - 0	
2.5 TD (ECL, EDS, EDL, EGL, ESS, EUS)	09.91 - 07.94	4GB 4GC				
2.0	09.91 - 09.94	NBA		3205.40.00	KZIS - 0	- GBox: MT75
2.0 i (EBL, EDL, EGL, ESS, EUS)	09.91 - 07.94	NCA				

TRANSIT Bus (E_) 06.94 - 07.00

2.5 DI (EBL, ECL, EDS, EDL)	07.94 - 03.00	4ED		2400.90.04  2403.20.00  2413.30.00  3205.40.00	240 23 MF240 240TD KZIS - 0	
2.5 DI (EBL, EDL, EDS, ESL, ESS)	08.97 - 03.00	4HB 4HC				

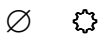



Vehicle list

					
---	---	---	--	---	---

FORD

TRANSIT Bus (E_)

06.94 - 07.00

2.5 DI (EBL, EDS, ESL, ESS, EUS)	08.94 - 03.00	4EB		2400.90.06	242 23	
2.5 TD (EB_, ED_, ES_)	08.94 - 06.00	4EC		2403.20.00	MF240	
2.5 TD (EBL, EDL, EDS, EGL, ESL, ESS, EUS)	01.95 - 03.00	4FA		2413.30.00	240TD	
2.5 TD (ECL, EDL, EDS, ESL, ESS, EUS)	07.94 - 03.00	4FB		3205.40.00	KZIS - 0	
		4FC				
		4FD				
		4GA				
		4GB				
		4GC				
		4GD				
		4GE				
		4GF				
		4HA				
		4HD				
2.0 (EBL, EBS, ECL, EDS, EDL, EGL, ESS, ESL, EUS)	09.95 - 03.00	NSF		3205.40.00	KZIS - 0	
2.0 CNG	06.94 - 03.00	NSG				
		NSH				

TRANSIT Bus (FD_, FB_, FS_)

01.00 - 05.06

2.3 16V [RWD] (F_B_, F_C_, F_A_)	08.00 - 05.06	D2FA		3205.40.00	KZIS - 0	
2.4 DI [RWD] (F_B_, F_C_)	01.00 - 05.06	D2FB				
2.4 DI (F_B_, F_C_, F_A_)	01.00 - 05.06	D2FE				
2.4 TDE	03.04 - 05.06	D4FA				
2.4 DI [RWD] (F_B_, F_C_, F_A_)	01.00 - 05.06	DOFA				
2.4 TDE (F_C_, F_B_, F_A_)	07.01 - 05.06	E5FA				
		E5FC				
		F4FA				
		FXFA				



TRANSIT Bus

04.06 -



2.4 TDCi, 74kW	04.06 - 08.14	PHFA		3205.40.00	KZIS - 0	- GBox: MT75
		PHFC				

GÜLERYÜZ (TÜRKİYE)







COBRA GD160

GD 160				3565.20.00	350	GMF350
				3576.30.00	350 10	350WGSZ

COBRA GD272























GD 272				4301.20.00	430	MFZ430
				4316.30.00	430 10	430WGTZ
				8935.40.00		KZISZ - 5

Vehicle list



					
---	---	---	--	---	---

IKARUS

100 - 542



250 255			 4234.20.00	420 GF420KR	- GBox: 5-G
			 4222.20.00	420 GF420KR	- GBox: 5-G
			 4203.30.00	420 10 420GS	- GBox: 5-G
			 4298.20.00	420 GF420	- GBox: 6-G
			 4237.20.00	420 GF420KR	- GBox: 6-G
			 4208.30.00	420 10 420GS	- GBox: 6-G
			 8514.40.00	KZI - 4,5	- GBox: 6-G
280 256			 4234.20.00	420 GF420KR	- GBox: 5-G
			 4222.20.00	420 GF420KR	- GBox: 5-G
			 4203.30.00	420 10 420GS	- GBox: 5-G
			 4298.20.00	420 GF420	- GBox: 6-G
			 4237.20.00	420 GF420KR	- GBox: 6-G
			 4208.30.00	420 10 420GS	- GBox: 6-G
			 8514.40.00	KZI - 4,5	- GBox: 6-G
266			 4234.20.00	420 GF420KR	- GBox: 5-G
			 4222.20.00	420 GF420KR	- GBox: 5-G
			 4203.30.00	420 10 420GS	- GBox: 5-G
			 4237.20.00	420 GF420KR	- GBox: 6-G
			 4208.30.00	420 10 420GS	- GBox: 6-G
			 8514.40.00	KZI - 4,5	- GBox: 6-G
			542		
 3126.30.00	310 10 310GSBL				
 5700.40.00	KZIZ - 3				

IK 212







IK 212			 3505.20.00	350 G350KR	
			 3516.30.00	350 10 350WGSZ	

IKARUS (TÜRKİYE)

IKARUS







MACAR			 4215.30.00	420 10 420 GSZ	
YUGOSLAV			 4221.30.00	420 10 420 GSZ	
MACAR - YUGOSLAV			 4222.20.00	420 GF420KR	

Vehicle list















					
---	---	---	--	---	---

IRISBUS



ARES 01.99 -

Ares		4311.20.00	430 MFZ430	- GBox: B8 TBV - GBox: ZF 6S-85 - GBox: ZF 8S-180 - GBox: ZF 10AS2301 - GBox: ZF 6S-1600
		4311.30.00	430 20 430W2GTZ	- GBox: B8 TBV
		8937.40.00	KZISZ-5	- GBox: B8 TBV - GBox: ZF 6S-85 - GBox: ZF 8S-180 - GBox: ZF 6S-1600
		4305.30.00	430 10 430W2GTZ	- GBox: ZF 8S-180 - To chassis no.: CAM 15K1 - GBox: ZF 10AS2301 - GBox: ZF 6S-1600 - From model year: 10.2001
		4312.30.00	430 10 430W2GTZ	- GBox: ZF 6S-85
		8919.40.00	KZISZ - 5	- GBox: ZF 6S-1600







ILIADE 01.99 -

Iliade		4300.90.61 ⊕	430 20 MFZ430	- From model year: 061997 - GBox: B9,B8 170R5 TBV
		4311.20.00	430W2GTZ	
		4311.30.00	KZISZ-5	
		8937.40.00		
		4300.90.60 ⊕	430 10 MFZ430	- From model year: 09.1997 - GBox: ZF S6-85
		4311.20.00	430W2GTZ	
		4312.30.00	KZISZ-5	
		8937.40.00		
		4300.90.54 ⊕	430 10 MFZ430	- GBox: ZF S8-180 - From model year: 10.1997 - From chassis no.: CAM 12KV
		4311.20.00	430WGTZ	
	4346.30.00	KZISZ-5		
	8937.40.00			
	4311.20.00	430 MFZ430	- GBox: ZF 6S-1600	
	8937.40.00	KZISZ-5	- GBox: ZF 6S-1600	



KAROSA 01.99 -

MIHR 062045		4335.60.00 ⊕	430 MFZ430	
		4312.30.00	430 10 430W2GTZ	
		8936.40.00	KZISZ - 5	

OBRADORE 01.99 -

Obradore		4300.90.61 ⊕	430 20 MFZ430	- GBox: B9/B8L
		4311.20.00	430W2GTZ	
		4311.30.00	KZISZ-5	
		8937.40.00		
		4311.20.00	430 MFZ430	- GBox: ZF S8-180
	4327.30.00	430 10 430GTZ	- GBox: ZF S8-180	
	8937.40.00	KZISZ-5	- GBox: ZF S8-180	

RÉCREO 01.99 -

C 935		4300.90.47 ⊕	430 10 MFZ430	- GBox: 5P 115
		4335.60.00	430W2GTZ	
		4312.30.00		

Vehicle list

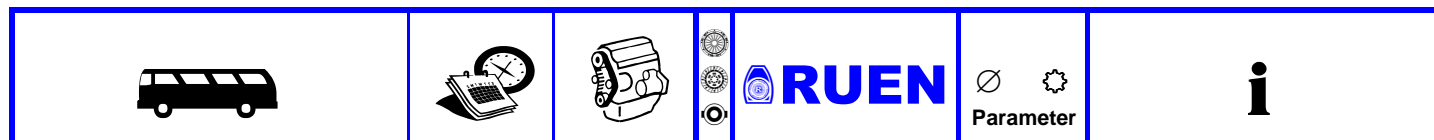

IVECO

Zeta 01.79 - 12.92

50-10	01.79 - 12.86	8040.04.200		3100.90.13	310 10	
50-10 H	01.79 - 12.86	8040.05.230		3169.20.00	MF310	
50-10 V	01.79 - 12.86	8040.25.230 R		3113.30.00	310GSBL	
50-8	01.83 - 12.86	8060.04.060		7903.40.00	KZI-4	
50-8 H	01.83 - 12.86	8060.04.660		2654.20.00	270	
50-8 V	01.83 - 12.86	8340.04.200			MF270	
50-9 11011111, 11011211, 11016211, 11016311, 11011311	01.87 - 03.91	8340.04.250		2656.30.00 *	270 10	
50-9 H 11011111, 11011211, 11016211, 11016311, 11011311	01.87 - 03.91	8340.04.300			270CTB	
50-9 V 11014211, 11014311	01.87 - 03.91	8340.04.362				
60-11 11076311, 11071111, 11071211, 11071311, 11076211	01.87 - 03.91					
60-11 V 11074311, 11074211	01.87 - 03.91					
79-13, Van/Estate	11.79 - 12.83					
79-13, Dump Truck	11.79 - 12.83					
79-13, Platform/Chassis	11.79 - 12.83					
60-8	11.79 - 12.82	8040.04.200		2514.20.00	250	
	11.79 - 12.81				H250K	
	11.79 - 12.83			2514.30.00	250 10	
					250CBL	
60-10	11.79 - 12.86	8340.04.200		2809.20.00	280	- To model year: 08.1983
60-10 H	11.79 - 12.86	8340.04.250			H280	
60-10 V	11.79 - 12.86			2810.20.00	280	- From model year: 09.1983
					H280K	
				2810.30.00	280 10	
					280CBL	
				5800.40.00	KZA - 2	- To model year: 02.1982
65-10	11.79 - 01.87	8340.04.200		2809.20.00	280	
65-10 H	11.79 - 01.87	8340.04.250			H280	
65-10 V	11.79 - 01.87	8340.04.300		2810.30.00	280 10	
		8340.04.350			280CBL	
65-12 11051331, 11056211, 11056311, 11051304, 11051431, 11051211, 11051311, 11051411, 11056331, 11051231, 11051204, 11056231	01.87 - 03.91	8040.25.200		3100.90.13	310 10	
		8040.25.220		3169.20.00	MF310	
				3113.30.00	310GSBL	
				7903.40.00	KZI-4	
65-12 H 11051331, 11056211, 11056311, 11051304, 11051431, 11051211, 11051311, 11051411, 11056331, 11051231, 11051204, 11056231	01.87 - 03.91					
65-12 V 11054231, 11054311, 11054304, 11054324, 11054211, 11054331	01.87 - 03.91					
79-12 11111111, 11131111, 11131211, 11116211, 11111311, 11111211, 11131311, 11136211, 7.49t	01.87 - 03.91					
79-12 11111111, 11131111, 11131211, 11116211, 11111311, 11111211, 11131311, 11136211, 8.10t	01.87 - 03.91					
79-12 H 11111111, 11131111, 11131211, 11116211, 11111311, 11111211, 11131311, 11136211, 7.49t	01.87 - 03.91					
79-12 H 11111111, 11131111, 11131211, 11116211, 11111311, 11111211, 11131311, 11136211, 8.10t	01.87 - 03.91					
79-12 V 11114204, 11134211, 11134204, 11114211, 8.10t	01.87 - 03.91					
79-12 V 11114204, 11134211, 11134204, 11114211, 7.49t	01.87 - 03.91					

Vehicle list

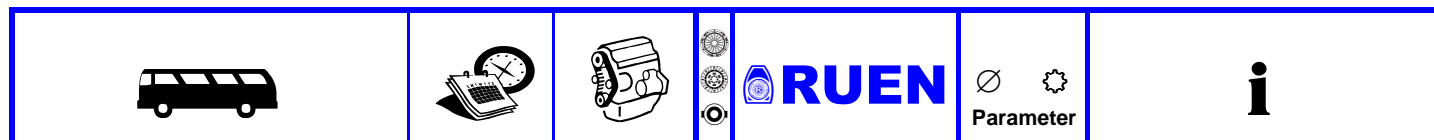







IVECO

Zeta 01.79 - 12.92







79-10, 8.00t	01.83 - 01.87	8340.04.200		2809.20.00	280 H280	- To model year: 08.1983
79-10, 7.49t	01.83 - 01.87	8340.04.300		2810.20.00	280 H280K	- From model year: 09.1983
79-10 H, 8.00t	01.83 - 01.87			2810.30.00	280 10 280CBL	
79-10 H, 7.49t	01.83 - 01.87					
79-10 V, 8.00t	01.83 - 01.87					
79-10 V, 7.49t	01.83 - 01.87			5800.40.00	KZA - 2	- From model year: 09.1983
79-14 31910231, 31910251, 31911131, 31911244, 31911331, 31916251, 31910244, 31911151, 31911251, 31916231, 31910224, 31911324, 7.49t	01.83 - 11.85	8060.04.660		3100.90.13	310 10 MF310	- From model year: 11.1984
79-14 31910231, 31910251, 31911131, 31911244, 31911331, 31916251, 31910244, 31911151, 31916231, 31910224, 31911324, 7.49t	01.83 - 11.85			3169.20.00	310GSBL	
79-14 31910231, 31910251, 31911131, 31911244, 31911331, 31916251, 31910244, 31911151, 31916231, 31910224, 31911324, 8.10t	01.83 - 11.85			3113.30.00	KZI-4	
79-14 H 31910231, 31910251, 31911131, 31911244, 31911331, 31916251, 31910244, 31911151, 31911251, 31916231, 31910224, 31911324, 7.49t	01.83 - 11.85			7903.40.00		
79-14 H 31910231, 31910251, 31911131, 31911244, 31911331, 31916251, 31910244, 31911151, 31911251, 31916231, 31910224, 31911324, 8.10t	01.83 - 11.85					
79-14 H 31910231, 31910251, 31911131, 31911244, 31911331, 31916251, 31910244, 31911151, 31911251, 31916231, 31910224, 31911324, 7.49t	01.83 - 11.85					
79-14 V 31914224, 31914231, 31914251, 31914244, 8.10t	01.83 - 11.85					
79-14 V 31914224, 31914231, 31914251, 31914244, 7.49t	01.83 - 11.85					
109-14 32111331, 32111131, 32111431, 32111231	11.85 - 03.91	8060.04.669		3100.90.13	310 10 MF310	
109-14 H 32111331, 32111131, 32111431, 32111231	11.85 - 03.91	8060.05.280		3169.20.00	310GSBL	
79-14 31910231, 31910251, 31911131, 31911244, 31911331, 31916251, 31910244, 31911151, 31911251, 31916231, 31910224, 31911324, 7.49t	12.85 - 03.91	8060.05.289		3113.30.00	KZI-4	
79-14 31910231, 31910251, 31911131, 31911244, 31911331, 31916251, 31910244, 31911151, 31911251, 31916231, 31910224, 31911324, 8.10t	12.85 - 03.91			7903.40.00		
79-14 H 31910231, 31910251, 31911131, 31911244, 31911331, 31916251, 31910244, 31911151, 31911251, 31916231, 31910224, 31911324, 7.49t	12.85 - 03.91					
79-14 H 31910231, 31910251, 31911131, 31911244, 31911331, 31916251, 31910244, 31911151, 31911251, 31916231, 31910224, 31911324, 8.10t	12.85 - 03.91					
79-14 V 31914224, 31914231, 31914251, 31914244, 8.10t	12.85 - 03.91					
79-14 V 31914224, 31914231, 31914251, 31914244, 7.49t	12.85 - 03.91					
95-14 32011131, 32011231, 32011331, 32011431	11.85 - 03.91					
95-14 H 32011131, 32011231, 32011331, 32011431	11.85 - 03.91					
109-14 32111331, 32111131, 32111431, 32111231	06.83 - 12.85	8060.04.669		3100.90.13	310 10 MF310	- From model year: 09.1983
109-14 H 32111331, 32111131, 32111431, 32111231	06.83 - 12.85	8060.04.689		3169.20.00	310GSBL	
95-14 32011131, 32011231, 32011331, 32011431	07.83 - 10.85			3113.30.00	KZI-4	
95-14 H 32011131, 32011231, 32011331, 32011431	07.83 - 10.85			7903.40.00		

Vehicle list

















					
---	---	---	--	---	---

IVECO













Zeta 01.79 - 12.92

65-9 11731311, 11731215, 11731211, 11731111, 11731315 A 60-9 92640011, 92630011 A 70-14 92750011, 92750031, 92750024	01.87 - 03.91	8040.05.200		2654.20.00	270 MF270	- Engine code: 8040
	09.88 - 12.92	8040.05.203		2656.30.00 *	270 10 270CTB	- Engine code: 8040
A 60-10 A 70-12	05.88 - 12.92	8040.05.230				
	11.79 - 06.88	8060.05.246				
	01.83 - 01.85	8060.05.285				
		8340.04.040		2810.20.00	280 H280K	- To model year: 08/1983
		8340.05.200		2810.30.00	280 10 280CBL	
				6301.40.00	KZI - 2	- From model year: 09/1983







300...

300 PC				4236.20.00	420 GF420KR	- To chassis no.: 014757
				4299.30.00	420 10 420GSZ	- To chassis no.: 014757
300 PC Hydro				4301.20.00	430 MFZ430	
				4299.30.00	420 10 420GSZ	
300 PT				4236.20.00	420 GF420KR	- To chassis no.: 04386
				4299.30.00	420 10 420GSZ	- To chassis no.: 04386
300-23				3804.20.00	380 G380KR	
				3812.30.00	380 10 380GSZ	
				7951.40.00	KZIS - 4	
300-25 AHB				4235.20.00	420 GF420KR	- GBox: ZF
				4208.30.00	420 10 420GS	- GBox: ZF
				8514.40.00	KZI - 4,5	- GBox: ZF
300-32 300-34				4253.20.00	420 GFX420KR	
				4268.30.00	420 10 420GSZ	
				8514.40.00	KZI - 4,5	
300 PC				4299.30.00	420 10 420GSZ	

DAILY II Bus 01.89 - 05.99





A 40-10 (94139111, 94139131, 94139311, 94139315...) A 40-10 (95719111, 95719131, 95719311, 95719315...) A 45-10 (94159111, 94159131, 94159211, 94159311...) A 45-10 (95739111, 95739131, 95739311, 95739317, 95739331)	01.91 - 12.96	8140.23. 8140.27.2720		2350.90.01	235 10 MFZ235	- Engine code: 8140.27S
	09.96 - 05.99			2353.20.00	235 10 235CBL	- GBox: 2826.5
	01.91 - 04.96			2354.30.00	235 10 KZIZ - 3	- From chassis no.: 5928513
A 45-10 (94159111, 94159131, 94159211, 94159311...) A 45-10 (95739111, 95739131, 95739311, 95739317, 95739331)	05.96 - 05.99			4500.40.00	235 10 KZIZ - 3	- Engine code: 8140.23
				2650.90.01	265 10 MF265	- Engine code: 8140.27S
				2651.20.00	265 10 265TB	- GBox: 2826.5
A 40-12 (95819311, 95819315, 95819317, 95819331) A 45-12 (95839211, 95839231, 95839311, 95839317...)	05.96 - 05.99	8140.43.		2655.30.00	280 10 280VBL	- Engine code: 8140.43
	05.96 - 05.99			4500.40.00	280 10 KZIZ - 3	- GBox: 2826.5
				2650.90.15	265 10 MFZ265	- Engine code: 8140.47
A 45-12 (94179211, 94179231, 94179311, 94179317...)	06.90 - 04.96	8140.47.2711 8140.47.2721		2658.20.00	265 10 265VTP	- GBox: 2826.5
				2678.30.00	265 10 KZIZ - 3	
				4500.40.00	265 10 KZIZ - 3	

Vehicle list



					
---	---	---	--	---	---

IVECO

A 55... - A 90...

A 55-10			 2809.20.00	280 H280	- To model year: 08.1983
			 2810.20.00	280 H280K	- From model year: 09.1983
			 2810.30.00	280 10 280CBL	- To model year: 08.1983 - From model year: 09.1983
			 5800.40.00	KZA - 2	- From model year: 09.1983



Bus

Midirider 27			 3953.20.00	395 MF395	
			 3952.30.00	395 10 395WGTZ	
			 7451.40.00	KZIS-4	



Eurorider

31 35 35 A		F2BE0682A F2BE0682F	 8919.40.00	KZISZ - 5	- GBox: S6-1600
------------------	--	------------------------	---	-----------	-----------------





Leoncino

Leoncino AL 5			 2809.20.00	280 H280	
			 2810.30.00	280 10 280CBL	

Lupetto



Lupetto AL 5			 2810.20.00	280 H280K	
			 2810.30.00	280 10 280CBL	

M 2000



M 2000	01.77 -		 4200.90.49	420 10	
			 4236.20.00	GF420KR	
			 4265.30.00	420GSZ	
			 8532.40.00	KZI - 4,5	

MAGELYS





07.11 -

Magelys Pro	07.11 -		 4303.20.00	430 MFZ430	- Engine code: Cursor 9 - GBox: 12 AS 2001, 6 S 1911
			 8939.40.00	KZISZ - 5	- Engine code: Cursor 9 - GBox: 12 AS 2001



Tigrotto

Tigrotto AL 5			 2810.20.00	280 H280K	
			 2810.30.00	280 10 280CBL	







50...

50 AL -000378			 2514.20.00	250 H250K	
			 2514.30.00	250 10 250CBL	
50 AL 000379-			 2514.20.00	250 H250K	
			 6301.40.00	KZI - 2	































315...

315-13			 3162.20.00	310 MF310	
			 3140.30.00	310 10 310W2GSZ	
			 6905.40.00	KZIS - 3	







Vehicle list

					
---	---	---	--	---	---

IVECO



315...					
315 8/17 315 /17			 3304.20.00	330 GMF330	
			 3308.30.00	330 10 330GSZ	
			 6905.40.00	KZIS - 3	
316...					
316-13			 3162.20.00	310 MF310	
			 3140.30.00	310 10 310W2GSZ	
			 6905.40.00	KZIS - 3	
329...					
329 A, B			 2810.20.00	280 H280K	
			 2810.30.00	280 10 280CBL	
331					
331 A 001003-			 3804.20.00	380 G380KR	
			 38115.30.00	380 10 380GSZ	
370...					
370-10 /20 370-10 /25 370-11 /25 370-12 /25 370-12 /26			 4200.90.49	420 10	- To chassis no.: 006654
			 4236.20.00	GF420KR	
			 4265.30.00	420GSZ	
			 8532.40.00	KZI - 4,5	
			 8531.40.00	KZI - 4,5	- To chassis no.: 006654
			 4277.20.00	420 GFX420KR	- From chassis no.: 006655
370-10 /24 370-12 /24 370-12 /25 L			 8510.40.00	KZI - 4,5	- From chassis no.: 006655
			 4277.20.00	420 GFX420KR	
			 4208.30.00	420 10 420GS	
370-12 /26 (Unic)			 8531.40.00	KZI - 4,5	
			 4200.90.49	420 10	
			 4236.20.00	GF420KR	
370-12 /30			 4265.30.00	420GSZ	
			 8532.40.00	KZI - 4,5	
			 4200.90.79	420 10	
370-12 /35			 4278.20.00	GFX420KR	
			 4268.30.00	420GSZ	
			 8512.40.00	KZI - 4,5	- GBox: Fiat, ZF
380...					
380.29 380.35 380.38	01.95 -		 4301.20.00	430 MFZ430	
	01.95 -		 4326.30.00	430 10 430WGTZ	
	01.95 -		 8919.40.00	KZISZ - 5	

Vehicle list



					
---	---	---	--	---	---

IVECO

409

409 B			 3804.20.00	380 G380KR	
			 38115.30.00	380 10 380GSZ	



























418

418 A/AC/AL	05.78 -		 3804.20.00	380 G380KR	
			 38115.30.00	380 10 380GSZ	







KAMAZ

5











01.69 -

5297-15 5350			 4300.90.44  4304.20.00  4316.30.00  8916.40.00	430 10 MFZ430 430WGTZ KZIZ - 5	- Engine code: 740.31-240 - Engine code: KAMAZ / YAMZ, 740.30-260 - GBox: KAMAZ 154
5308	05.11 -	ISBe4 300	 3953.20.00  7451.40.00	395 MF395 KZIS-4	- Engine code: Cummis ISBe 4 300 - GBox: ZF 16 S 109 - Engine code: Cummis ISBe 4 300 - GBox: ZF 16 S 109
5360, 191kW 5360, 265kW 5460	05.86 - 05.86 - 05.03 -	740.30 740.50	 4300.90.65  4304.20.00  4332.30.00  8916.40.00	430 10 MFZ430 430GTZ KZIZ - 5	- Engine code: 740.30-260 - GBox: KAMAZ-154 - GBox: 16S 151
5490	12.13 -		 8939.40.00  8916.40.00	KZISZ - 5 KZIZ - 5	- Engine code: OM457 - GBox: ZF AS Tronic - Engine code: OM457 - GBox: ZF 16 S 2221
53205 53215 53228 53229 53605, 176kW 54115 55111, Platform/Chassis, 6x4 55111, Dump Truck, 6x4	05.06 - 05.04 - 05.99 - 05.99 - 05.05 - 05.84 - 05.82 - 05.82 -	740.11 740.31	 3951.20.00  3870.30.00  3962.30.00  8533.40.00	395 MF395 380 10 380/210GSZ 395 10 395GTZ	- Engine code: 740.11-240, 740.13-240, 740.31-240 - GBox: KAMAZ-152 - Vehicles with double disc clutch - Loose clutch disc - Engine code: 740.11-240, 740.13-240, 740.31-240 - GBox: KAMAZ-152
53215	11.05 -		 3951.20.00  3962.30.00  8533.40.00  4300.90.65  4304.20.00  4332.30.00  8916.40.00  4301.20.00  4335.30.00  8935.40.00	395 MF395 395 10 395GTZ 430 10 MFZ430 430GTZ KZIZ - 5 430 MFZ430 430 10 430GTZ	- Engine code: KAMAZ / YAMZ, 740.31-240, 740.11-240, 740.13-260 - GBox: KAMAZ, 141 142 152 - Engine code: KAMAZ / YAMZ, 740.31-240, 740.11-240, 740.13-260 - GBox: KAMAZ, 141 142 152 - Engine code: KAMAZ / YAMZ, 740.31-240 - GBox: ZF-Ecosplit 16S-151 - Engine code: KAMAZ / YAMZ, 740.31-240 - GBox: ZF-Ecomit 9S-109 - Engine code: KAMAZ / YAMZ, 740.31-240 - GBox: ZF-Ecomit 9S-109 - Engine code: KAMAZ / YAMZ, 740.31-240 - GBox: ZF-Ecomit 9S-109



Vehicle list

					
---	---	---	--	---	---











KAMAZ

5		01.69 -				
53605, 191kW	05.05 -	740.30	 4300.90.65	430 10	- Engine code: 740.30-260	
			 4304.20.00	MFZ430	- GBox: KAMAZ-154	
			 4332.30.00	430GTZ		
			 8916.40.00	KZIZ - 5		
			 3951.20.00	395	- Engine code: 740.11-240, 740.13-240,	
				MF395	740.31-240	
					- GBox: KAMAZ-152	
 4301.20.00	430	- Engine code: 740.30-260				
	MFZ430	- GBox: KAMAZ-154				
 4332.30.00	430 10	- Engine code: 740.30-260				
	430GTZ	- GBox: KAMAZ-154				
 3870.30.00	380 10	- Vehicles with double disc clutch				
	380/210GSZ	- Loose clutch disc				
 3962.30.00	395 10	- Engine code: 740.11-240, 740.13-240,				
	395GTZ	740.31-240				
		- GBox: KAMAZ-152				
 8916.40.00	KZIZ - 5	- Engine code: 740.30-260				
		- GBox: KAMAZ-154				
 8533.40.00	KZI - 4,5	- Engine code: 740.11-240, 740.13-240,				
		740.31-240				
		- GBox: KAMAZ-152				







LAZ

BUS						
Bus			 4301.20.00	430		
				MFZ430		
			 4316.30.00	430 10		
				430WGTZ		
			 8935.40.00	KZISZ - 5		

MAGIRUS-DEUTZ













110...						
112 D 9 AS			 3505.20.00	350		
				G350KR		
			 3519.30.00	350 10		
				350GSZ		
110 E 6			 2819.30.00	280 10		
				280GSZ		
130...						
130 D 7 FA 130 D 9 AL 130 D 9 AS,L 130 D 13 AK 130 D 13 K,L 130 D 14 FL 130 D 15 AK, K 130 D 17 FA	- 06.77 - 03.77		 6905.40.00	KZIS - 3		
			 2955.20.00	295		
				GF295		
130 D 9 AL	07.77 -		 3563.20.00	350		
				GMF350		
			 3564.30.00	350 10		
				350GSZ		
			 8514.40.00	KZI - 4,5		
130 D 9 FA			 2955.20.00	295	- For: Version 2550361	
				GF295		
			 6905.40.00	KZIS - 3	- For: Version 2550361	

Vehicle list













					
---	---	---	--	---	---

MAGIRUS-DEUTZ

130...

130 D 9 FA, FL				3162.20.00	310 MF310	
130 D 11 FL				3113.30.00	310 10 310GSBL	
130 D 12 AK, K				6905.40.00	KZIS - 3	
130 D 13 FL						
130 D 15 K						
130 D 16 FL, FLL						
130 M 7 FL, FAL						
130 M 8 FL, FS, FK, FAL						
130 M 9 FL, FS, FK, FG						
130 M 11 FL, FK						
130 M 13 FL						
130 M 13 FL, FGB, FK						
130 D 11 F, H, K				2955.20.00	295 GF295	
130 D 12 F, H, K				6905.40.00	KZIS - 3	
130 D 15 F, H, K						
130 D 13 AK	04.77 -			3563.20.00	350 GMF350	
				3564.30.00	350 10 350GSZ	
				8505.40.00	KZI - 4,5	
135 D 10, D 12, D 14 FS, FL				3131.20.00	310 G310	
				3108.30.00	310 310GSZ	
130 L 81				3162.20.00	310 MF310	- Engine code: F6 L913
130 R 81				3140.30.00	310 10 310W2GSZ	- Engine code: F6 L913
				6905.40.00	KZIS - 3	- Engine code: F6 L913

150...

150 ,150/1F				3505.20.00	350 G350KR	
150 AK 6x6	- 02.62			3519.30.00	350 10 350GSZ	
150 D 13 FL, FS						
150 D 14						
156 D 15 K						
150 AK 6x6	03.62 -			3505.20.00	350 G350KR	
150 L 6x4				3519.30.00	350 10 350GSZ	
156 D 22						
150 D 10 A				3519.30.00	350 10 350GSZ	
150 D 14 AK				3131.20.00	310 G310	
				3108.30.00	310 310GSZ	
150 D 22 FL 6x4				3505.20.00	350 G350KR	
				3519.30.00	350 10 350GSZ	
156 D 14 K				3505.20.00	350 G350KR	
156 D 15 AK				3519.30.00	350 10 350GSZ	
156 D 16 AK						
150 E 100				3505.20.00	350 G350KR	
150 R/L 10				3512.30.00	350 10 350W2GSZ	
150 S 10						

Vehicle list

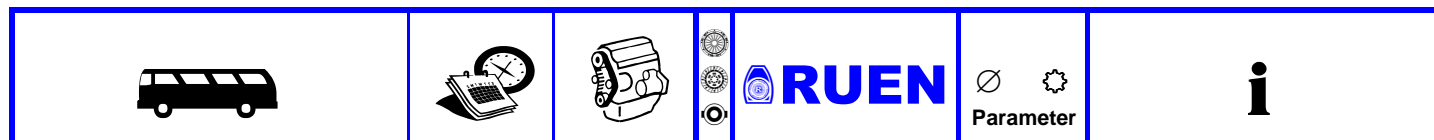

MAGIRUS-DEUTZ







150...

150 R/L 10, 12			3505.20.00	350 G350KR	
			3519.30.00	350 10 350GSZ	
150 S 11 M			3807.20.00	380 G380KR	- Engine code: F6 L413
			3805.30.00	380 10 380WGSZ	- Engine code: F6 L413







160...

160 D 11 FL, FS 160 D 12 K 160 D 15 K 160 D 16 FL, FLL 160 M 11 FL, FS			3573.20.00	350 MF350	
			3563.30.00	350 10 350GSZ	
			6905.40.00	KZIS - 3	
160 D 11-D 17			3563.20.00	350 GMF350	
			3519.30.00	350 10 350GSZ	
			8514.40.00	KZI - 4,5	
160 D 12 AK 168 M 13 FL 168 M 16 FL	01.82 -		3563.20.00	350 GMF350	
			3583.30.00	350 10 350GSZ	
			8514.40.00	KZI - 4,5	
160 D 12 AK	- 12.81		2955.20.00	295 GF295	
			6905.40.00	KZIS - 3	
160 D 16 FL			3563.20.00	350 GMF350	
			3519.30.00	350 10 350GSZ	
160 M 11 FA, FS, FK 160 M 13 FL, FS, FK 160 M 7 FA 160 M 8 FL, FAL 168 M 11 FL, FAL			3570.20.00	350 GMF350	
			3585.30.00	350 10 350GSZ	
			6905.40.00	KZIS - 3	
160 M 11 FK (Version 2550435)			3166.20.00	310 MF310	
			3113.30.00	310 10 310GSBL	
			6905.40.00	KZIS - 3	
168 M 14 FK 168 M 14 FL (Version 42230423)			3563.20.00	350 GMF350	
			3565.20.00	350 GMF350	
			3585.30.00	350 10 350GSZ	
			8514.40.00	KZI - 4,5	
168 M 14 FL			3563.20.00	350 GMF350	- For: Version 61602271
			3564.30.00	350 10 350GSZ	- For: Version 61602271
			8514.40.00	KZI - 4,5	- For: Version 61602271







Vehicle list

					
---	---	---	--	---	---

MAGIRUS-DEUTZ





160...					
160 L 81				3300.20.00	330 GFM330
160 R 81				3328.30.00	330 10 330WGSZ
				6905.40.00	KZIS - 3
170...					
170 D 10 AK				3505.20.00	350 G350KR
170 D 11 F				3519.30.00	350 10 350GSZ
170 D 11 FA	- 11.83				
170 D 21 AK 6x6					
170 D 11 FA	12.83 -			3563.20.00	350 GMF350
				3564.30.00	350 10 350GSZ
				8514.40.00	KZI - 4,5
170 D 11 FL				3505.20.00	350 G350KR
170 D 12 AK, AL				3512.30.00	350 10 350W2GSZ
170 D 12, FL					
170 D 13 FS, FL					
170 D 15 AK, FAK, FK, K					
170 D 15 FL					
170 D 16 FL					
170 D 16 K					
170 D 17 F, K, AK					
170 D 19 L, FL, AL					
170 D 24 K, L					
170 D 14 SL, FL, FS				3505.20.00	350 G350KR
				3512.30.00	350 10 350W2GSZ
170 D 19 F				3804.20.00	380 G380KR
				3805.30.00	380 10 380WGSZ
170 E 100				3505.20.00	350 G350KR
170 L 100				3512.30.00	350 10 350W2GSZ
170 R 100					
170 TR 100					
170 TR 100 (Version 2547212)					
170 SH 110				3807.20.00	380 G380KR - Engine code: F6 L413
				3805.30.00	380 10 380WGSZ - Engine code: F6 L413
200...					
200 D 15 FAK				3804.20.00	380 G380KR
200 D 18				3812.30.00	380 10 380GSZ
200 D 16				3804.20.00	380 G380KR
200 D 26				3899.30.00	380 10 380GSZ
200 D F, K, AK, S, L					
200 D FS, FL 6x4					
200 D 16 F				3804.20.00	380 G380KR
200 D 22 B				3812.30.00	380 10 380GSZ
				7951.40.00	KZIS - 4

Vehicle list







					
---	---	---	--	---	---

MAGIRUS-DEUTZ





















200...

200 E 12 200 LS /RS 12				3807.20.00	380 G380KR	- Engine code: F8 L312
200 R/L 200 SH 110				3805.30.00	380 10 380WGSZ	- Engine code: F8 L312
200 E 110				3804.20.00	380 G380KR	
				3805.30.00	380 10 380WGSZ	

220...

228 M 16 AK				3895.20.00	380 G380KR	
				3816.30.00	380 10 380GSZ	
				8514.40.00	KZI - 4,5	
226 L 117				4298.20.00	420 GF420	- GBox: S 4-90
				4249.30.00	420 10 420W2GSZ	- GBox: S 4-90
				8514.40.00	KZI - 4,5	- GBox: S 4-90

230...

230 D 16 F				3810.20.00	380 G380KR	
				3812.30.00	380 10 380GSZ	
				7951.40.00	KZIS - 4	
230 D 16 FAK				3804.20.00	380 G380KR	
				3812.30.00	380 10 380GSZ	
230 D 18 AK 230 D 19 FL 230 D 22 K				3810.20.00	380 G380KR	
				3812.30.00	380 10 380GSZ	
				3861.30.00	380 10 380W2GSZ	
230 D 22 FT 6x6				3804.20.00	380 G380KR	
				3812.30.00	380 10 380GSZ	
				3861.30.00	380 10 380W2GSZ	
				7951.40.00	KZIS - 4	
230 D 26 AK				3810.20.00	380 G380KR	
				3812.30.00	380 10 380GSZ	
232 D 15 FK, FAK, FS, FL 232 D 16 F, AK, FS, FL 232 D 19 AK, K, FAK, FK, FL, FS, L, S 232 D 22 AK, FAK, FK 6x6, FB 6x4 232 D 24 L, K, FK 232 D 26 AK, F, FAK, FB, FK, K, L, S				3804.20.00	380 G380KR	
				3812.30.00	380 10 380GSZ	
				3861.30.00	380 10 380W2GSZ	
				7951.40.00	KZIS - 4	
232 D 16 AL 232 D 20 AL				3895.20.00	380 G380KR	
				3816.30.00	380 10 380GSZ	
				8514.40.00	KZI - 4,5	

Vehicle list

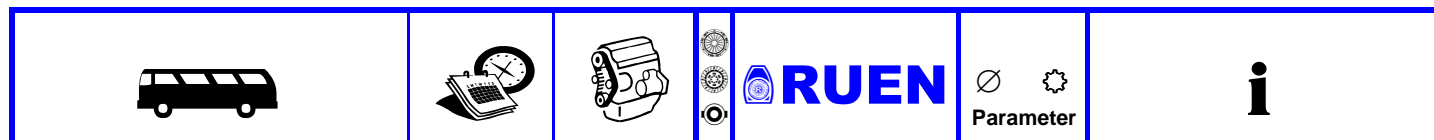

MAGIRUS-DEUTZ

230...

232 D 17		4226.20.00	420 GF420KR
		4222.20.00	420 GF420KR
		4236.30.00	420 10 420/210GSZ
		8514.40.00	KZI - 4,5
232 D 17 F, FA 232 D 19 K, L 232 D 26 K 6x4		3804.20.00	380 G380KR
		3812.30.00	380 10 380GSZ
		7951.40.00	KZIS - 4
232 D 17 FA (Version 42230187)		3563.20.00	350 GMF350
		3564.30.00	350 10 350GSZ
		8514.40.00	KZI - 4,5
232 D 20 AL (Version 2551578) 232 D 26 B 232 D 32 K		3804.20.00	380 G380KR
		3812.30.00	380 10 380GSZ
		7951.40.00	KZIS - 4
232 D 30 AK, FAK 232 D 30 FK 232 D 32 A		3804.20.00	380 G380KR
		3812.30.00	380 10 380GSZ
		3861.30.00	380 10 380W2GSZ
		7951.40.00	KZIS - 4
235 D 22 FL, FS 6x4		3895.20.00	380 G380KR
		3812.30.00	380 10 380GSZ
		7951.40.00	KZIS - 4
230 E 100 230 E 110		3804.20.00	380 G380KR
		3805.30.00	380 10 380WGSZ
		8505.40.00	KZI - 4,5
230 E 100 (Version 2547021)		3505.20.00	350 G350KR
		3512.30.00	350 10 350W2GSZ
230 E 113 (Version 2547018) 230 E 120 230 L 120 230 T 117		3804.20.00	380 G380KR
		3805.30.00	380 10 380WGSZ
230 E 113 (Version 42246020/42/71) 230 E 117 230 T 117 (Version 42246022)		3804.20.00	380 G380KR
		3857.30.00	380 10 380W2GSZ
		8514.40.00	KZI - 4,5
230 E 113 (Version 42246069)		3895.20.00	380 G380KR
		3857.30.00	380 10 380W2GSZ
		8514.40.00	KZI - 4,5

Vehicle list

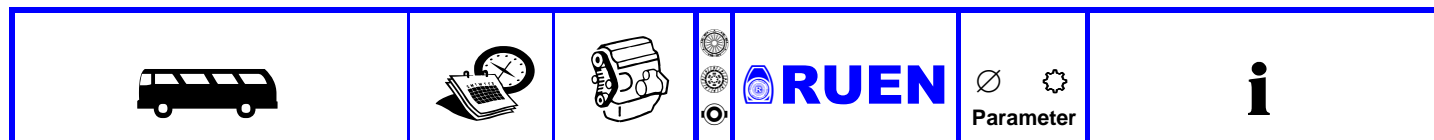

MAGIRUS-DEUTZ

230...

230 E 113 (Version 42246073)		4237.20.00	420 GF420KR	
		4249.30.00	420 10 420W2GSZ	
		4272.30.00	420 10 420WGSZ	
		8514.40.00	KZI - 4,5	
230 EV 110 230 EV 120		3804.20.00	380 G380KR	
		3857.30.00	380 10 380W2GSZ	
		8505.40.00	KZI - 4,5	
230 L 117		3804.20.00	380 G380KR	- GBox: S 6-70/3, S 6-65
		3805.30.00	380 10 380WGSZ	- GBox: S 6-70/3
		3857.30.00	380 10 380W2GSZ	- GBox: S 6-65
		6905.40.00	KZIS - 3	- GBox: S 6-70/3, S 6-65
		4298.20.00	420 GF420	- Engine code: F8 L413F - GBox: S 6-65
		4249.30.00	420 10 420W2GSZ	- Engine code: F8 L413F - GBox: S 6-65
		8514.40.00	KZI - 4,5	- Engine code: F8 L413F - GBox: S 6-65
230 R 100 230 R 120 230 TR 100 230 TR 120		3804.20.00	380 G380KR	- Engine code: F8 L413
		3805.30.00	380 10 380WGSZ	- Engine code: F8 L413
230 SH 110		3804.20.00	380 G380KR	- GBox: S 6-70/3
		3805.30.00	380 10 380WGSZ	- GBox: S 6-70/3
		6905.40.00	KZIS - 3	- GBox: S 6-70/3
		3895.20.00	380 G380KR	- GBox: F8 L914
		3816.30.00	380 10 380GSZ	- GBox: F8 L914

260...

260 D FAL 6x6		4226.20.00	420 GF420KR	
		4222.20.00	420 GF420KR	
		4236.30.00	420 10 420/210GSZ	
		8514.40.00	KZI - 4,5	
260 E 113 (Version 42246065/70)		3895.20.00	380 G380KR	
		3857.30.00	380 10 380W2GSZ	
		8514.40.00	KZI - 4,5	
260 E 113 (Version 42246068) 260 T 117		3804.20.00	380 G380KR	
		3857.30.00	380 10 380W2GSZ	
		8514.40.00	KZI - 4,5	

Vehicle list

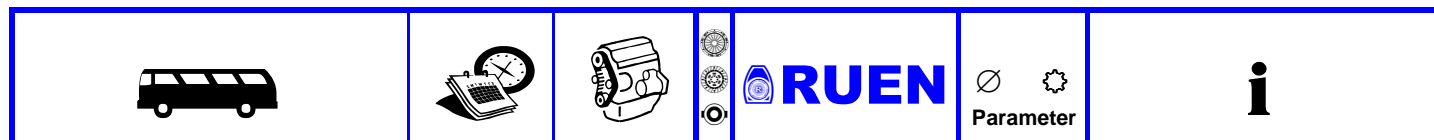

MAGIRUS-DEUTZ

260...

260 E 113 (Version 42246073/79)		4237.20.00	420 GF420KR	
		4249.30.00	420 10 420W2GSZ	
		4272.30.00	420 10 420WGSZ	
		8514.40.00	KZI - 4,5	
260 L 117		3804.20.00	380 G380KR	- GBox: S 6-65
		3857.30.00	380 10 380W2GSZ	- GBox: S 6-65
		6905.40.00	KZIS - 3	- GBox: S 6-65
		4298.20.00	420 GF420	- Engine code: F8 L413F
		4249.30.00	420 10 420W2GSZ	- Engine code: F8 L413F
		8514.40.00	KZI - 4,5	- Engine code: F8 L413F
260 R 106 260 R 119		4237.20.00	420 GF420KR	
		4272.30.00	420 10 420WGSZ	
		8514.40.00	KZI - 4,5	
260 SH 110		4298.20.00	420 GF420	- Engine code: F8 L413F - GBox: S 6-65
		4249.30.00	420 10 420W2GSZ	- Engine code: F8 L413F - GBox: S 6-65
		8514.40.00	KZI - 4,5	- Engine code: F8 L413F - GBox: S 6-65

280...

280 M 26 FS		4224.20.00	420 GF420KR	
		4235.20.00	420 GF420KR	
		4257.30.00	420 10 420GSZ	
		8514.40.00	KZI - 4,5	
280 E 113		4237.20.00	420 GF420KR	
		4249.30.00	420 10 420W2GSZ	
		4272.30.00	420 10 420WGSZ	
		8514.40.00	KZI - 4,5	

O 3500...

O 3500 O 3500 V 6		3552.30.00	350 10 350	
----------------------	--	-------------------	----------------------	--







Saturn I - III

Saturn I (O3500H) Saturn II /II IS Saturn III /LS/MS		3505.20.00	350 G350KR	
		3519.30.00	350 10 350GSZ	

2000



2000		4298.20.00	420 GF420	- GBox: S 6-65
		3857.30.00	380 10 380W2GSZ	- GBox: S 6-65
		8514.40.00	KZI - 4,5	- GBox: S 6-65

Vehicle list





					
---	---	---	--	---	---

MAN



EM 08.87 -

EM 192 EM 223	10.93 - 06.97	D 0826 LOH 06		3573.20.00	350 MF350	
	08.87 -	D 0826 LOH 15		3576.30.00	350 10 350WGSZ	
				6905.40.00	KZIS - 3	

















EL 01.93 - 01.01

EL 262	07.98 -	D 2866 LUH 22		8916.40.00	KZIZ - 5	
EL 202,EL 222 EL 202,EL 262	04.94 - 06.97	D 0826 LUH		4008.30.00	400 10 400 WGVZ	
	04.94 - 06.97	D 0826 LUH 03		8916.40.00	KZIZ - 5	
		D 0826 LUH 05				
		D 0826 LUH 12				









G 10.79 - 08.88

9.136 FOC	03.82 - 07.88	D 0226 MF		3573.20.00	350 MF350	
				3563.30.00	350 10 350GSZ	
				6905.40.00	KZIS - 3	

L 2000 10.93 -

8.150 FOC,8.150 FOCL	02.95 -	D 0824 LFO		3300.90.08	330 10	
				3313.20.00	MFZ330	
				3309.30.00	330GSZ	
				3620.90.10	362 10	
				3610.20.00	MFZ362	
				3610.30.00	362GTZ	
				3610.20.00	362 MFZ362	
				3610.30.00	362 10 362GTZ	
				3573.20.00	350 MF350	
				3576.30.00	350 10 350WGSZ	
8.220 FOC,8.220 FOCL 10.220 FOC,10.220 FOCL	04.95 -	D 0826 LFL03		6905.40.00	KZIS - 3	
	02.95 -					
10.150 FOC	02.95 - 01.96	D 0824 LFO		3620.90.10	362 10	
				3610.20.00	MFZ362	
				3610.30.00	362GTZ	
				3610.20.00	362 MFZ362	
				3610.30.00	362 10 362GTZ	

LION'S COACH 10.93 -

FRH 352,RH 353	09.95 -	D 2866 LOH 26		4300.90.05	430 10	- GBox: ZF S8-180
				4301.20.00	MFZ430	
				4346.30.00	430WGTZ	
				8916.40.00	KZIZ - 5	
FRH 402,RH 403	09.95 -	D 2866 LOH 23		4300.90.49	430 10	- GBox: ZF S8-180
				4301.20.00	MFZ430	
				4346.30.00	430WGTZ	
				8916.40.00	KZIZ - 5	
				43460.30.00	430 10 430WGTZ	- GBox: ZF S8-180

Vehicle list

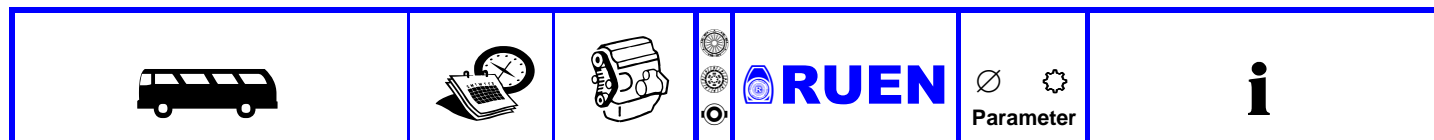

MAN

LION'S COACH 10.93 -

RH 352 RH 422	05.96 -		4300.90.03 4301.20.00 4334.30.00 8916.40.00	430 10 MFZ430 430GTZ KZIZ - 5	- GBox: ZF S8-180
	05.96 -		4300.90.49 4301.20.00 4346.30.00 8916.40.00	430 10 MFZ430 430WGTZ KZIZ - 5	- Engine code: D 2866 LOH 23
			43460.30.00	430 10 430WGTZ	- Engine code: D 2866 LOH 23
RH 402	05.96 -		4300.90.03 4301.20.00 4334.30.00 8916.40.00	430 10 MFZ430 430GTZ KZIZ - 5	- GBox: ZF S8-180
			4300.90.49 4301.20.00 4346.30.00 8916.40.00	430 10 MFZ430 430WGTZ KZIZ - 5	- Engine code: D 2866 LOH 23
			43460.30.00	430 10 430WGTZ	- Engine code: D 2866 LOH 23
RH 403	09.98 -	D 2866 LOH 23	4300.90.03 4301.20.00 4334.30.00 8916.40.00	430 10 MFZ430 430GTZ KZIZ - 5	- GBox: ZF S8-180
			4300.90.49 4301.20.00 4346.30.00 8916.40.00	430 10 MFZ430 430WGTZ KZIZ - 5	- Engine code: D 2866 LOH 23
			43460.30.00	430 10 430WGTZ	- Engine code: D 2866 LOH 23
RH 463, RHC 464	01.00 -	D 2876 LOH 01 D 2876 LOH 02 D 2876 LOH 03	4300.90.03 4301.20.00 4334.30.00 8916.40.00	430 10 MFZ430 430GTZ KZIZ - 5	- GBox: ZF S8-180
			4301.20.00	430 MFZ430	- GBox: ZF S8-180
			4306.30.00	430 10 430WGTZ	- GBox: ZF S8-180
			8916.40.00	KZIZ - 5	- GBox: ZF S8-180
			4300.90.12 4339.20.00 4386.30.00 8919.40.00	430 10 MFZ430 430WGTZ KZISZ - 5	- GBox: AS-Tronic
			4300.90.77 4339.20.00 4386.30.00 8939.40.00	430 10 MFZ430 430WGTZ KZISZ - 5	- GBox: AS-Tronic
			4300.90.182 43100.20.00 43134.30.00 8916.40.00	430 10 MFZ430E 430WGTZ KZIZ - 5	- Engine code: D2876LOH3 - GBox: ZF 8S-180 - Only install together

Vehicle list

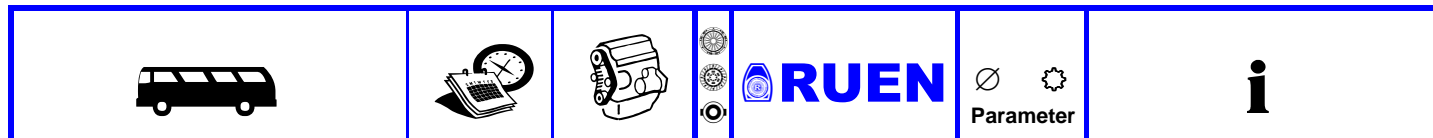

MAN

LION'S COACH







10.93 -

RHC 414	06.02 -	D 2866 LOH 34	4300.90.03 4301.20.00 4334.30.00 8916.40.00	430 10 MFZ430 430GTZ KZIZ - 5	- GBox: ZF 8S-180
			4319.20.00	430 MFZ430	- GBox: AS-Tronic
			4306.30.00	430 10 430WGTZ	- GBox: AS-Tronic
			8919.40.00	KZISZ - 5	- GBox: AS-Tronic
			4300.90.184 43100.20.00 43461.30.00 8916.40.00	430 10 MFZ430E 430WGTZ KZIZ - 5	- Engine code: D2866LOH34 - GBox: ZF 8S-180 - Only install together

LION'S REGIO





























Lion's Regio L	04.03 -		4319.20.00	430 MFZ430	- GBox: AS-Tronic
			4306.30.00	430 10 430WGTZ	- GBox: AS-Tronic
			8919.40.00	KZISZ - 5	- GBox: AS-Tronic
			4300.90.184 43100.20.00 43461.30.00 8916.40.00	430 10 MFZ430E 430WGTZ KZIZ - 5	- Engine code: D2866 LUH29/37 - GBox: ZF 6S-1900 - Only install together
Lion's Regio			4319.20.00	430 MFZ430	- GBox: AS-Tronic
			4306.30.00	430 10 430WGTZ	- GBox: AS-Tronic
			8919.40.00	KZISZ - 5	- GBox: AS-Tronic
			4300.90.183 43100.20.00 43461.30.00 8916.40.00	430 10 MFZ430E 430WGTZ KZIZ - 5	- Engine code: D2866 LUH28 - GBox: ZF 6S-1900 - Only install together
			4300.90.184 43100.20.00 43461.30.00 8916.40.00	430 10 MFZ430E 430WGTZ KZIZ - 5	- Engine code: D2866 LUH29/37 - GBox: ZF 6S-1900 - Only install together
Lion's Regio 13M			4319.20.00	430 MFZ430	- GBox: AS-Tronic
			4306.30.00	430 10 430WGTZ	- GBox: AS-Tronic
			8919.40.00	KZISZ - 5	- GBox: AS-Tronic
			4300.90.183 43100.20.00 43461.30.00 8916.40.00	430 10 MFZ430E 430WGTZ KZIZ - 5	- Engine code: D2866 LUH28 - GBox: ZF 6S-1900 - Only install together
			4300.90.184 43100.20.00 43461.30.00 8916.40.00	430 10 MFZ430E 430WGTZ KZIZ - 5	- Engine code: D2866 LUH29/37 - GBox: ZF 6S-1900 - Only install together

Vehicle list







					
---	---	---	--	---	---

MAN

LION'S STAR 03.91 -

















FRH 322			 4304.30.00	430 10 430WGTZ	- GBox: ZF6S-85 - From model year: 01.1991
			 8939.40.00	KZISZ - 5	- From model year: 01.1991 - GBox: ZF6S-85 - GBox: ZF8S-180
			 4301.20.00	430 MFZ430	- From model year: 01.1991 - GBox: ZF8S-180
			 4300.30.00	430 10 430GTZ	- From model year: 01.1991 - GBox: ZF8S-180
			 4314.30.00	430 10 430WGTZ	- Engine code: D2865,2866LOH - Transmission type: ZF6S-85 - From model year: 01/1991
FRH 352,RH 353	09.95 -	D 2866 LOH 26	 4300.90.03	430 10 MFZ430 430GTZ KZIZ - 5	- GBox: ZF8S-180
			 4301.20.00	430 MFZ430	- GBox: ZF8S-180 - GBox: ZF 6S-85
			 4316.30.00	430 10 430WGTZ	- GBox: ZF 6S-85
			 8939.40.00	KZISZ - 5	- GBox: ZF 8S-180 - GBox: ZF 6S-85
FRH 402	04.91 - 09.92		 4300.90.03	430 10 MFZ430 430GTZ KZIZ - 5	- GBox: ZF 8S-180
FRH 402,RH 403	09.95 -	D 2866 LOH 23	 4301.20.00	430 10 MFZ430 430GTZ KZIZ - 5	- GBox: ZF 8S-180
			 4300.90.03	430 10 MFZ430 430GTZ KZIZ - 5	- GBox: ZF 8S-180
			 8939.40.00	KZISZ - 5	- GBox: ZF 8S-180
FRH 422	01.93 - 09.96	D 2866 LOH 20	 4301.20.00	430 MFZ430	- GBox: ZF 8S-180
			 4300.30.00	430 10 430GTZ	- GBox: ZF 8S-180
			 8939.40.00	KZISZ - 5	- GBox: ZF 8S-180 - GBox: ZF 6S-85
			 4304.30.00	430 10 430WGTZ	- GBox: ZF 6S-85
FRH 462	04.91 -		 4314.30.00	430 10 430WGTZ	- Engine code: D2865,2866LOH - Transmission type: ZF6S-85
			 4300.90.03	430 10 MFZ430 430GTZ KZIZ - 5	- GBox: ZF 8S-180
			 4301.20.00	430 10 MFZ430 430GTZ KZIZ - 5	- GBox: ZF 8S-180
			 8939.40.00	KZISZ - 5	- GBox: ZF 8S-180
RH 414, RHS 414 R03 RH 464, RHS 464	03.00 - 01.02 -	D 2866 LOH 34 D 2876 LOH 03	 4300.90.12	430 10 MFZ430 430WGTZ KZISZ - 5	- GBox: AS-Tropic
			 4300.90.77	430 10 MFZ430 430WGTZ KZISZ - 5	- GBox: AS-Tropic
RH 464, RHS 464	03.00 -	D 2876 LOH 03	 4339.20.00	430 10 MFZ430 430WGTZ KZISZ - 5	- GBox: AS-Tropic
			 4386.30.00	430 10 MFZ430 430WGTZ KZISZ - 5	- GBox: AS-Tropic
			 8939.40.00	KZISZ - 5	- GBox: AS-Tropic
RH 464, RHS 464	03.00 -	D 2876 LOH 03	 4300.20.00	430 MFZ430	- GBox: ZF 8S-180 - GBox: AS-Tropic
			 4300.30.00	430 10 430GTZ	- GBox: ZF 8S-180 - GBox: AS-Tropic
			 8935.40.00	KZISZ - 5	- GBox: ZF 8S-180 - GBox: AS-Tropic

Vehicle list











					
---	---	---	--	---	---

MAN







N 03.02 -

N 4516 Centro-E, 191kW	03.02 -	D 2866 LUH 23	 4301.20.00	430 MFZ430	- GBox: ZF 6S-85
			 4316.30.00	430 10 430WGTZ	- GBox: ZF 6S-85
			 8916.40.00	KZIZ - 5	- GBox: ZF 6S-85
			 4300.90.185 	430 10 MFZ430E	- Engine code: D2866LUH23
			 43100.20.00	430WGTZ	- GBox: ZF S6-85
			 4356.30.00	430WGTZ	- Only install together
			 8916.40.00	KZIZ - 5	
N 4516 Centro-E, 228kW	03.02 -	D 2866 LUH 24	 4301.20.00	430 MFZ430	- GBox: ZF 6S-85
			 4316.30.00	430 10 430WGTZ	- GBox: ZF 6S-85
			 8916.40.00	KZIZ - 5	- GBox: ZF 6S-85
			 4300.90.185 	430 10 MFZ430E	- Engine code: D2866LUH23
			 43100.20.00	430WGTZ	- GBox: ZF S6-85
			 4356.30.00	430WGTZ	- Only install together
			 8916.40.00	KZIZ - 5	



NL 09.88 -

NL 202,NL 222,NL 223	08.92 -	D 0826 LUH 03 D 0826 LUH 12	 4301.20.00	430 MFZ430	- GBox: S 6-85
			 4316.30.00	430 10 430WGTZ	- GBox: S 6-85
			 8916.40.00	KZIZ - 5	- GBox: S 6-85
NL 202,NL 262,NL 263	04.91 -	D 0826 LUH	 4301.20.00	430 MFZ430	- GBox: S 6-85
			 4316.30.00	430 10 430WGTZ	- GBox: S 6-85
			 8916.40.00	KZIZ - 5	- GBox: S 6-85
NL 223 NL 263 NL 313	01.96 -		 4301.20.00	430 MFZ430	
	01.96 -		 4316.30.00	430 10 430WGTZ	
	01.96 -		 8916.40.00	KZIZ - 5	
NL 262,NL 263 NL 313	07.98 -	D 2866 LUH 22	 4316.30.00	430 10 430WGTZ	- GBox: S 6-85
	07.98 -	D 2866 LUH26	 8916.40.00	KZIZ - 5	- GBox: S 6-85







NM 08.87 -

NM 152 NM 182,NM 192 NM 223	05.90 - 10.93	D 0826 LOH 01	 3573.20.00	350 MF350	
	05.90 - 03.97	D 0826 LOH 15	 3596.30.00	350 10 350WGSZ	
	08.87 -	D 0826 OH02	 6905.40.00	KZIS - 3	
M 222,NM 223	02.96 -	D 0826 LOH 15 D 0826 LUH 12	 3573.20.00	350 MF350	- GBox: ZF S6-36/6S-890
			 3596.30.00	350 10 350WGSZ	- GBox: Eaton 4106
			 6905.40.00	KZIS - 3	- GBox: ZF S6-36/6S-890
			 3576.30.00	350 10 350WGSZ	- GBox: Eaton 4106

NÜ 03.96 -





















NÜ 223	09.96 -	D 0826 LUH 12	 8916.40.00	KZIZ - 5	
NÜ 263, 6871cc	07.98 -	D 0826 LUH 13	 8916.40.00	KZIZ - 5	

Vehicle list







					
---	---	---	--	---	---

MAN



NÜ 03.96 -

NÜ 263, 9973cc	09.96 - 07.98	D 2865 LUH09		8916.40.00	KZIZ - 5	
NÜ 263, 11967cc	07.98 -	D 2866 LUH 22		4301.20.00	430 MFZ430	
				4316.30.00	430 10 430WGTZ	
				8916.40.00	KZIZ - 5	
				4300.90.185 	430 10 MFZ430E 430WGTZ KZIZ - 5	- Engine code: D2866LUH22 - Only install together
NÜ 313	07.98 -	D 2866 LUH26		4301.20.00	430 MFZ430	
				4316.30.00	430 10 430WGTZ	
				8916.40.00	KZIZ - 5	
				4300.90.185 	430 10 MFZ430E 430WGTZ KZIZ - 5	- Engine code: D2866LUH26 - Only install together
NÜ 313 15M	07.98 -	D 2866 LUH26		4301.20.00	430 MFZ430	
				4316.30.00	430 10 430WGTZ	
				8916.40.00	KZIZ - 5	
				4300.90.185 	430 10 MFZ430E 430WGTZ KZIZ - 5	- Engine code: D2866LUH26 - Only install together
NÜ 353 15M	07.98 -	D 2866 LUH 21		4300.90.05	430 10 MFZ430 430WGTZ KZIZ - 5	
				4301.20.00		
				4346.30.00		
				8916.40.00		

R 05.85 - 01.93

R 292,FR 292,FRH 292	05.85 - 01.93	D 2866 TOH/310 D 2866 TUH/290		4244.20.00	420 GFX420KR	
				4281.30.00	420 10 420WGVZ	
				7951.40.00	KZIS - 4	
				4275.30.00	420 10 420W2GSZ	
FRH 362	05.85 - 12.92	D 2866 KUH/360		4244.20.00	420 GFX420KR	
				4281.30.00	420 10 420WGVZ	
				7951.40.00	KZIS - 4	

SG 09.72 -

SG 220				4226.20.00	420 GF420KR	
				4222.20.00	420 GF420KR	
				4249.30.00	420 10 420W2GSZ	

Vehicle list

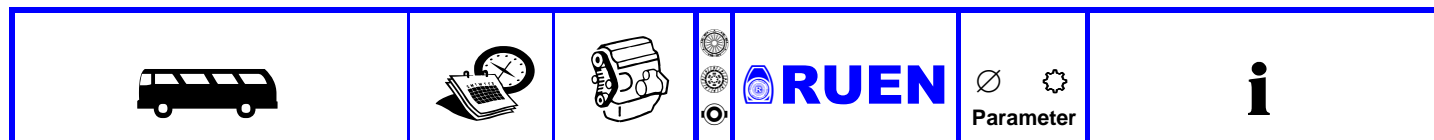

MAN

SL 06.72 - 04.87

SL 200				3835.20.00	380 GF380	
				3857.30.00	380 10 380W2GSZ	
				4224.20.00	420 GF420KR	
				4235.20.00	420 GF420KR	
				4249.30.00	420 10 420W2GSZ	

SL II 04.84 - 05.96

SL 202, 147/155kW SL 202, 177/180kW	06.84 - 04.93	D 2566 UH		4249.30.00	420 10 420W2GSZ	- From model year: 06.1991
	06.84 - 04.94	D 2866 UH/240				- Special design
				7951.40.00	KZIS - 4	- From model year: 07.1991







SM 08.87 -

SM 152 SM 182, SM 192	11.87 - 04.94	D 0826 LOH 01		3573.20.00	350 MF350	
	11.87 - 02.95	D 0826 OH02		3596.30.00	350 10 350WGSZ	
				6905.40.00	KZIS - 3	

SR 02.75 - 08.94



SR 240	10.75 - 06.83	D 2566 MUH/240		4224.20.00	420 GF420KR	
				4235.20.00	420 GF420KR	
				4249.30.00	420 10 420W2GSZ	
SR 280, SR 280 H	01.77 - 11.86	D 2566 MTUH		4250.30.00	420 10 420WGSZ	
SR 281 SR 321 H	03.82 - 11.86	D 2566 MKUH/320		4244.20.00	420 GFX420KR	
				4281.30.00	420 10 420WGVZ	
SR 292	07.90 -			4244.20.00	420 GFX420KR	
				4249.30.00	420 10 420W2GSZ	
SR 292	08.90 -			4245.20.00	420 GFX420KR	
				4275.30.00	420 10 420W2GSZ	
SR 332 H	07.90 -			4244.20.00	420 GFX420KR	
				4249.30.00	420 10 420W2GSZ	
SR 332 H	08.90 -			4245.20.00	420 GFX420KR	
				4275.30.00	420 10 420W2GSZ	
SR 361 SR 362 H	08.90 -			4245.20.00	420 GFX420KR	
				4275.30.00	420 10 420W2GSZ	
SR 362 H	07.90 -			4244.20.00	420 GFX420KR	
				4249.30.00	420 10 420W2GSZ	

Vehicle list































					
---	---	---	--	---	---

MAN







SR 02.75 - 08.94

SR 321 H	03.82 - 11.86	D 2566 MKUH/320	 4244.20.00	420 GFX420KR	
			 4281.30.00	420 10 420WGVZ	
			 7951.40.00	KZIS - 4	

SÜ 04.93 - 05.95







SÜ 18.223 (Türkei) SÜ 18.253 (Türkei) SÜ 18.263 (Türkei) SÜ 18.313 (Türkei)	05.99 -	D 0826 LOH D 2866 LUH26	 4300.90.05	430 10 MFZ430	
			 4301.20.00	430WGTZ	
			 4346.30.00	KZIZ - 5	
			 8916.40.00	KZIZ - 5	
SÜ 210			 4205.20.00	420 G420KR	
			 4283.30.00	420 10 420WGSZ	
SÜ 224			 3835.20.00	380 GF380	
			 3857.30.00	380 10 380W2GSZ	
			 4226.20.00	420 GF420KR	
			 4222.30.00	420 10 420BH	
			 4249.30.00	420 10 420W2GSZ	
SÜ 230 SÜ 240	01.72 -		 4226.20.00	420 GF420KR	
			 4222.20.00	420 GF420KR	
			 4249.30.00	420 10 420W2GSZ	
SÜ 240, 147/150kW SÜ 240, 177kW	05.80 - 09.89 10.75 - 01.86	D 2566 MUH/200 D 2566 MUH/240 D 2566 UH/205	 4249.30.00	420 10 420W2GSZ	
			 4226.20.00	420 GF420KR	
			 4222.20.00	420 GF420KR	
			 7951.40.00	KZIS - 4	
SÜ 240, 213kW	01.86 - 09.89	D 2866 TOH/290	 4281.30.00	420 10 420WGVZ	
			 7951.40.00	KZIS - 4	
SÜ 240, 206kW	11.82 - 01.86	D 2566 MTUH	 4249.30.00	420 10 420W2GSZ	
SÜ 242	01.87 -		 4244.20.00	420 GFX420KR	
			 4249.30.00	420 10 420W2GSZ	
SÜ 242	01.87 - 04.93	D 2866 UH/240	 4249.30.00	420 10 420W2GSZ	
SÜ 272	04.93 - 05.95	D 2865 LUH02	 4249.30.00	420 10 420W2GSZ	
			 8505.40.00	KZI - 4,5	
			 4301.20.00	430 MFZ430	
			 4316.30.00	430 10 430WGTZ	
			 8916.40.00	KZIZ - 5	
SÜ 280	01.82 - 12.92		 4249.30.00	420 10 420W2GSZ	

Vehicle list





















					
---	---	---	--	---	---

MAN



SÜ 04.93 - 05.95

SÜ 292 SÜ 322	04.92 - 04.93 05.95 - 06.97	D 2865 LUH08 D 2866 TOH/310		4245.20.00	420 GFX420KR	- GBox: ZF S6-90
				4281.30.00	420 10 420WGVZ	- GBox: ZF S6-90
				8505.40.00	KZI - 4,5	- GBox: ZF S6-90
				4244.20.00	420 GFX420KR	
SÜ 240	01.86 - 09.89	D 2866 UH/240		4291.20.00	420 GTF420	
				4250.30.00	420 10 420WGSZ	
				7951.40.00	KZIS - 4	







ÜL 09.89 -

ÜL 242 ÜL 272	06.91 -			4301.20.00	430 MFZ430	
				4316.30.00	430 10 430WGTZ	
				8916.40.00	KZIZ - 5	
ÜL 242	09.89 - 03.93	D 2866 UH/240		4249.30.00	420 10 420W2GSZ	- To model year: 06.1991 - From model year: 07.1991
ÜL 272	03.93 -	D 2865 LUH02 D 2865 LUH05		4301.20.00	430 MFZ430	
				4316.30.00	430 10 430WGTZ	
				8916.40.00	KZIZ - 5	
ÜL 272	03.93 -			4249.30.00	420 10 420W2GSZ	
ÜL 292	09.89 - 03.93	D 2866 TUH 01		4244.20.00	420 GFX420KR	
				4281.30.00	420 10 420WGVZ	
ÜL 312, ÜL 322	04.92 - 09.96	D 2865 LUH07 D 2865 LUH08		4244.20.00	420 GFX420KR	
				4281.30.00	420 10 420WGVZ	
				4301.20.00	430 MFZ430	
				4316.30.00	430 10 430WGTZ	
				8916.40.00	KZIZ - 5	
ÜL 313 ÜL 353	09.96 - 06.97 -	D 2866 LUH 20 D 2866 LUH 21 D 2866 LUH26		4301.20.00	430 MFZ430	- GBox: S 6-1600
				4300.30.00	430 10 430GTZ	
				8916.40.00	KZIZ - 5	- GBox: S 6-1600
				4316.30.00	430 10 430WGTZ	
				4306.30.00	430 10 430WGTZ	- GBox: S 6-1600
	4305.30.00	430 10 430W2GTZ	- GBox: S 6-1600			





































10...

10.136 HOCL,HOCL 10.150 HOCL,HOCL 10.180 HOCL,HOCL				3573.20.00	350 MF350	
				3596.30.00	350 10 350WGSZ	
				6905.40.00	KZIS - 3	







Vehicle list

					
---	---	---	--	---	---































MAN

10...					
10.150			 3573.20.00	350 MF350	
			 3510.30.00	350 10 350W2GSZ	
			 6905.40.00	KZIS - 3	
10.180			 3573.20.00	350 MF350	
			 3510.30.00	350 10 350W2GSZ	
			 6905.40.00	KZIS - 3	
10.180	01.87 - 12.92		 3500.90.04	350 10	
			 3573.20.00	MF350	
			 3587.30.00	350GSZ	
			 6905.40.00	KZIS - 3	
10.190 10.220 10.230			 3573.20.00	350 MF350	
			 3510.30.00	350 10 350W2GSZ	
			 6905.40.00	KZIS - 3	
11...					
11.150			 3573.20.00	350 MF350	
			 3510.30.00	350 10 350W2GSZ	
			 6905.40.00	KZIS - 3	
11.150	01.93 -		 3500.90.04	350 10	
			 3573.20.00	MF350	
			 3587.30.00	350GSZ	
			 6905.40.00	KZIS - 3	
11.180			 3573.20.00	350 MF350	
			 3510.30.00	350 10 350W2GSZ	
			 6905.40.00	KZIS - 3	
11.180	01.93 -		 3500.90.04	350 10	
			 3573.20.00	MF350	
			 3587.30.00	350GSZ	
			 6905.40.00	KZIS - 3	
11.190 11.192 11.230 HOCL/R	01.93 - 01.91 - 12.92 01.93 -		 3500.90.04	350 10	
			 3573.20.00	MF350	
			 3587.30.00	350GSZ	
			 6905.40.00	KZIS - 3	
11.192 HOCL,HOCL			 3573.20.00	350 MF350	
			 3596.30.00	350 10 350WGSZ	
			 6905.40.00	KZIS - 3	
12...					
12.220 HOCL/R-SR	02.02 -	D 0836 LOH	 3573.20.00	350 MF350	
			 3596.30.00	350 10 350WGSZ	
			 6905.40.00	KZIS - 3	







Vehicle list

					
---	---	---	--	---	---

MAN

























13...						
13.210 HOCL/R 13.230 HOCL/R	07.94 -	D 0826 LUH		3573.20.00	350 MF350	- GBox: ZFS6-39, 6S-890
	07.94 -			3510.30.00	350 10 350W2GSZ	- GBox: ZFS6-39, 6S-890 - To model year: 07.2001
				3596.30.00	350 10 350WGSZ	- GBox: ZFS6-39, 6S-890 - From model year: 08.2001
				6905.40.00	KZIS - 3	- GBox: ZFS6-39, 6S-890
13.220 HOCL/R	07.94 -			3573.20.00	350 MF350	- GBox: ZFS6-39, 6S-890
				3510.30.00	350 10 350W2GSZ	- To model year: 07.2001 - GBox: ZFS6-39, 6S-890
				3596.30.00	350 10 350WGSZ	- From model year: 08.2001 - GBox: ZFS6-39, 6S-890
				6905.40.00	KZIS - 3	- GBox: ZFS6-39, 6S-890
13.220 HOCL-SKD	02.01 -	D 0826 LOH 15		3573.20.00	350 MF350	
				3596.30.00	350 10 350WGSZ	
				6905.40.00	KZIS - 3	
14...						
14.280 HOCL/R	04.01 -	D 0836 LOH D 0836 LOH 02		4301.20.00	430 MFZ430	- GBox: ZF S6-85
				4316.30.00	430 10 430WGTZ	- GBox: ZF S6-85
				8916.40.00	KZIZ - 5	- GBox: ZF S6-85
				4300.90.05	430 10	- GBox: ZF S6-1600
				4301.20.00	MFZ430	
				4346.30.00	430WGTZ	
				8916.40.00	KZIZ - 5	
16...						
16.240				4244.20.00	420 GFX420KR	
				4281.30.00	420 10 420WGVZ	
				8505.40.00	KZI - 4,5	
16.240 HOC	01.79 - 08.96			3835.20.00	380 GF380	- GBox: ZF S6-80
				3857.30.00	380 10 380W2GSZ	- GBox: ZF S6-80
16.240 HOCL/R 16.280 HOCL/R	02.79 - 08.96 02.79 - 08.96			3835.20.00	380 GF380	
				3857.30.00	380 10 380W2GSZ	
16.240 HOCL/R	04.89 -	D 2866 OH		4224.20.00	420 GF420KR	
				4281.30.00	420 10 420WGVZ	
16.280 HOC	01.79 - 08.96			3835.20.00	380 GF380	- GBox: ZF S6-80
				3857.30.00	380 10 380W2GSZ	- GBox: ZF S6-80
				4224.20.00	420 GF420KR	- GBox: ZF S6-90
				4250.30.00	420 10 420WGSZ	- GBox: ZF S6-90

Vehicle list

					
---	---	---	--	---	---

MAN

16...

16.290				4301.20.00	430 MFZ430	
				4316.30.00	430 10 430WGTZ	
				8916.40.00	KZIZ - 5	
16.290 HOC	01.79 - 08.96	D 2866 TOH		4224.20.00	420 GF420KR	- To model year: 07.1990
				4250.30.00	420 10 420WGSZ	- To model year: 07.1990
				4244.20.00	420 GFX420KR	- From model year: 08.1990
				4281.30.00	420 10 420WGVZ	- From model year: 08.1990
16.290 HOCL/R	02.79 - 08.96			4224.20.00	420 GF420KR	- To model year: 07.1990 - From model year: S 6-90
				4235.20.00	420 GF420KR	- To model year: 07.1990 - GBox: S 6-90
				4250.30.00	420 10 420WGSZ	- To model year: 07.1990 - GBox: S 6-90
				4244.20.00	420 GFX420KR	- From model year: 08.1990 - GBox: S 6-90
				4281.30.00	420 10 420WGVZ	- From model year: 08.1990 - GBox: S 6-90
16.290 HOCL/R	04.89 -	D 2866 TOH		4253.20.00	420 GFX420KR	- To model year: 06.1995
				4244.20.00	420 GFX420KR	- To model year: 06.1995
				4281.30.00	420 10 420WGVZ	- To model year: 06.1995
				4301.20.00	430 MFZ430	- From model year: 07.1995
				4316.30.00	430 10 430WGTZ	- From model year: 07.1995
				8916.40.00	KZIZ - 5	- From model year: 07.1995
16.360 HOCL/R	02.79 - 08.96			4244.20.00	420 GFX420KR	- From model year: 07.1990 - GBox: S6-150
				4281.30.00	420 10 420WGVZ	- From model year: 07.1990 - GBox: S6-150
16.370 HOCL/R	04.89 -	D 2866 LOH		4245.20.00	420 GFX420KR	
				4275.30.00	420 10 420W2GSZ	
16.372 HOCL/R	02.79 - 08.96			4245.20.00	420 GFX420KR	- GBox: S6-150
				4275.30.00	420 10 420W2GSZ	- GBox: S6-150

18...

18.220 HOCL-SKD 18.230 HOCL-SKD 18.250 HOCL-SKD				8916.40.00	KZIZ - 5	
---	--	--	---	-------------------	----------	--

Vehicle list

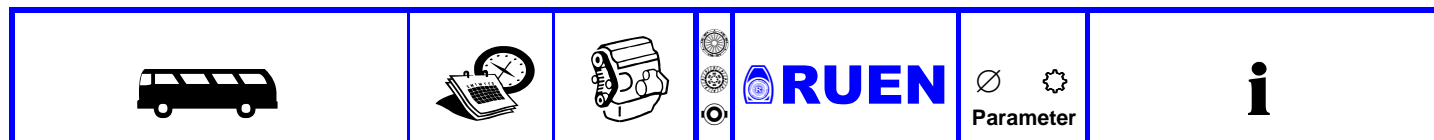

MAN

18...

18.310 HOCL/R 18.310 HOCL/R-SKD	01.92 -	D 2866 LOH	4300.90.05	430 10	- GBox: ZF S6-1600
	01.95 -	D 2876 LOH 03 D2866 LOH 25	4301.20.00 4346.30.00 8916.40.00	MFZ430 430WGTZ KZIZ - 5	
			4301.20.00	430	- GBox: ZF S6-85 - GBox: ZF S6-1600
			4316.30.00	430 10	- GBox: ZF S6-85
			8916.40.00	430WGTZ KZIZ - 5	- GBox: ZF S6-85 - GBox: ZF S6-1600
18.313 HOCL/R-SKD 18.350 HOCL/R 18.370 HOCL/R	01.95 -	D 2866 LOH	4300.90.05	430 10	- GBox: ZF S6-1600
	01.92 -	D 2866 LOH 27	4301.20.00 4346.30.00 8916.40.00	MFZ430 430WGTZ KZIZ - 5	
	01.92 -	D 2876 LOH 03	4300.90.183	430 10	- Engine code: D2866LOH - GBox: ZF S6-1600 - Only install together
			43100.20.00 43461.30.00 8916.40.00	MFZ430E 430WGTZ KZIZ - 5	
18.350 HOCL/R-SKD	01.95 -	D 2866 LOH 26	4300.90.03	430 10	- GBox: ZF 8S-180
			4301.20.00 4334.30.00 8916.40.00	MFZ430 430GTZ KZIZ - 5	
			4300.90.05	430 10	- GBox: ZF S6-1600
			4301.20.00 4346.30.00 8916.40.00	MFZ430 430WGTZ KZIZ - 5	
			4300.90.183	430 10	- Engine code: D2866LOH - GBox: ZF S6-1600 - Only install together
18.360 HOCL/R	06.02 -	D 2866 LOH 28 D 2866 LOH 33	4300.90.05	430 10	- GBox: ZF S6-1600
			4301.20.00 4346.30.00 8916.40.00	MFZ430 430WGTZ KZIZ - 5	
18.370 HOCL/R-SKD	01.95 -	D 2866 LOH	4300.90.03	430 10	- GBox: ZF S6-180
			4301.20.00 4334.30.00 8916.40.00	MFZ430 430GTZ KZIZ - 5	
			4300.90.184	430 10	- Engine code: D2866LOH26 - GBox: ZF 8S-180 - Only install together
			43100.20.00 43461.30.00 8916.40.00	MFZ430E 430WGTZ KZIZ - 5	

Vehicle list

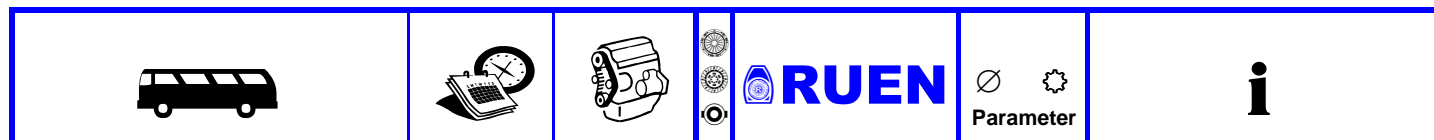

MAN







18...

18.400 HOCL/R	01.92 -	D 2866 LOH D 2876 LOH 03	4300.90.05 4301.20.00 4346.30.00 8916.40.00	430 10 MFZ430 430WGTZ KZIZ - 5	- GBox: ZF S6-1600
			4300.90.03 4301.20.00 4334.30.00 8916.40.00	430 10 MFZ430 430GTZ KZIZ - 5	- GBox: ZF 8S-180
			4300.90.184 ■ 43100.20.00 43461.30.00 8916.40.00	430 10 MFZ430E 430WGTZ KZIZ - 5	- Engine code: D2866LOH26 - GBox: ZF 8S-180 - Only install together
18.400 HOCL/R-SKD	01.95 -	D 2866 LOH 23	4300.90.03 4301.20.00 4334.30.00 8916.40.00	430 10 MFZ430 430GTZ KZIZ - 5	- GBox: ZF 8S-180
			4300.90.184 ■ 43100.20.00 43461.30.00 8916.40.00	430 10 MFZ430E 430WGTZ KZIZ - 5	- Engine code: D2866LOH26 - GBox: ZF 8S-180 - Only install together
18.410 HOCL/R	06.02 -	D 2866 LOH 29 D 2866 LOH 34	4300.90.03 4301.20.00 4334.30.00 8916.40.00	430 10 MFZ430 430GTZ KZIZ - 5	- GBox: ZF 8S-180
18.420 HOCL/R 18.420 HOCL/R-SKD	01.92 - 01.95 -	D 2866 LOH D 2866 LOH 20 D 2876 LOH 03	4300.90.03 4301.20.00 4334.30.00 8916.40.00	430 10 MFZ430 430GTZ KZIZ - 5	- GBox: ZF 8S-180
			4300.90.184 ■ 43100.20.00 43461.30.00 8916.40.00	430 10 MFZ430E 430WGTZ KZIZ - 5	- Engine code: D2866LOH26 - GBox: ZF 8S-180 - Only install together
18.460 HOCL/R	01.92 -	D 2876 LOH	4301.20.00	430 MFZ430	- GBox: ZF 8S-180
			4306.30.00	430 10 430WGTZ	- GBox: ZF 8S-180
			8916.40.00	KZIZ - 5	- GBox: ZF 8S-180
			4300.90.182 ■ 43100.20.00 43134.30.00 8916.40.00	430 10 MFZ430E 430WGTZ KZIZ - 5	- GBox: ZF 8S-180 - Only install together































24...

24.350 HOCLN	01.97 -	D 2866 LOH 26	4300.90.03 4301.20.00 4334.30.00 8916.40.00	430 10 MFZ430 430GTZ KZIZ - 5	- GBox: ZF 8S-180
			4300.90.184 ■ 43100.20.00 43461.30.00 8916.40.00	430 10 MFZ430E 430WGTZ KZIZ - 5	- Engine code: D2866LOH26 - GBox: ZF 8S-180 - Only install together







Vehicle list

					
---	---	---	--	---	---

MAN



24...					
24.400 HOCLN	01.97 -	D 2866 LOH 23	 4300.90.03	430 10	- GBox: ZF 8S-180 MFZ430 430GTZ KZIZ - 5
			 4301.20.00  4334.30.00  8916.40.00		
			 4300.90.184 	430 10	- Engine code: D2866LOH26 - GBox: ZF 8S-180 - Only install together MFZ430E 430WGTZ KZIZ - 5
			 43100.20.00  43461.30.00  8916.40.00		
530					
530 HOR			 3131.20.00	310 G310	
535					
535			 3505.20.00	350 G350KR	
			 3517.30.00	350 10 350WGSZ	
			 3575.30.00	350 10 350WGSZ	
			 8505.40.00	KZI - 4,5	
535 HO	04.72 -		 3505.20.00	350 G350KR	
			 3588.30.00	350 10 350GSZ	
535 HO	05.72 -		 3505.20.00	350 G350KR	
			 3516.30.00	350 10 350WGSZ	
630					
630			 3552.30.00	350 10 350	
750					
750 HO			 4224.20.00	420 GF420KR	
			 4235.20.00	420 GF420KR	
			 4203.30.00	420 10 420GS	
750 HO,SÜ,R,Ü (Daimler Chrysler Motor)			 4222.20.00	420 GF420KR	
			 4283.30.00	420 10 420WGSZ	
750 SL	09.72 -		 4224.20.00	420 GF420KR	
			 4235.20.00	420 GF420KR	
			 4283.30.00	420 10 420WGSZ	
750 SL	08.72 -		 4224.20.00	420 GF420KR	
			 4235.20.00	420 GF420KR	
750 SL			 8505.40.00	KZI - 4,5	
750 HO			 3831.30.00	380 10 380GSZ	

Vehicle list













					
---	---	---	--	---	---

MAN

890



890 UG,UO			 4224.20.00	420 GF420KR	
			 4235.20.00	420 GF420KR	
			 4203.30.00	420 10 420GS	

HOCL

18.310 HOCL/R A51	01.92 -		 4300.90.49	430 10 MFZ430	
			 4301.20.00	MFZ430	
			 4346.30.00	430WGTZ	
			 8916.40.00	KZIZ - 5	
			 4300.90.56	430 10 MFZ430	
			 4319.20.00	MFZ430	
			 4346.30.00	430WGTZ	
			 8939.40.00	KZISZ - 5	
			 4300.90.13	430 10 MFZ430	
 4319.20.00	MFZ430				
 4346.30.00	430WGTZ				
 8919.40.00	KZISZ - 5				

MAN (TÜRKİYE)



5.90 - (19-20-21-22)190 SERISI

5.90 - 19.190			 3505.20.00	350 G350KR	
			 3597.30.00	350 10 350 WGTZ	



SL 222 - SL 232

SL 232 D0826 LOH Motorlu			 4008.30.00	400 10 400 WGVZ	
--------------------------	--	--	---	---------------------------	--

SR 240 - SL 200







SR 240 - SL 200			 4235.20.00	420 GF420KR	
			 4281.30.00	420 10 420WGVZ	

FORTUNA - FORTUNA MEGA







FORTUNA			 4301.20.00	430 MFZ430	
			 4306.30.00	430 10 430WGTZ	
			 8916.40.00	KZIZ - 5	

MAZ

Bus



103-070			 4301.20.00	430 MFZ430	- GBox: ZF 6S-85
			 4316.30.00	430 10 430WGTZ	- GBox: ZF 6S-85
			 8935.40.00	KZISZ - 5	- GBox: ZF 6S-85
152-050			 4301.20.00	430 MFZ430	- Engine code: MAN D2866 LOH - GBox: ZF 6S-1600
			 4316.30.00	430 10 430WGTZ	- Engine code: MAN D2866 LOH - GBox: ZF 6S-1600
			 8935.40.00	KZISZ - 5	- Engine code: MAN D2866 LOH - GBox: ZF 6S-1600

Vehicle list



					
---	---	---	--	---	---

MERCEDES (TÜRKİYE)



O 309

O 309		2507.20.00	250 HBX250
		2528.30.00	250 10 250BHZX



OM 352

OM 352		3101.20.00	310 GFX310
		3104.30.00	310 10 310GSBL



O 302

O302		3522.20.00	350 GF350KR
		3519.30.00	350 10 350GSZ



O 302 TURBO S

O302 TURBO S		3821.20.00	380 GF380KR
		3831.30.00	380 10 380GSZ



AVRUPA 303

AVRUPA O303		3821.20.00	380 GF380KR
		38106.30.00	380 10 380WGTZ





O 303 (V6 - V8)

O303		4235.20.00	420 GF420KR
		4250.30.00	420 10 420WGSZ
		4281.30.00	420 10 420WGVZ



O 304

O304		4304.20.00	430 MFZ430
		4306.30.00	430 10 430WGTZ
		8928.40.00	KZIZ - 5







O 403

O 403 OM457LA - EURO 3		4300.20.00	430 MFZ430
		4306.30.00	430 10 430WGTZ
O 403 - O 404 - O 345 EURO 1 - 2		4304.20.00	430 MFZ430
		4306.30.00	430 10 430WGTZ



















TRAVEGO - TOURISMO - INTOURO

TRAVEGO 15 SHD (OM457L-EURO 3)		4300.20.00	430 MFZ430
		4306.30.00	430 10 430WGTZ

Vehicle list

					
---	---	---	--	---	---

MERCEDES-BENZ

T2/LN1 Bus		07.87 - 12.92				
O 609 D (672.072, 672.073)	07.87 - 12.92	OM 364.913	 2837.20.00	280 MFZ280	- Engine code: OM364	
			 2822.30.00	280 10 280GTZ	- Engine code: OM364	
			 5700.40.00	KZIZ - 3	- Engine code: OM364	
O 611 D (672.372, 672.373) O 614 D (672.375, 672.376)	07.87 - 12.92	OM 364.952	 3176.20.00	310 MFZ310	- Engine code: OM364	
		OM 364.954	 3126.30.00	310 10 310GSBL	- Engine code: OM364 - Engine code: OM354, OM364	
	OM 364.980	 5700.40.00	KZIZ - 3	- Engine code: OM364		
	OM 364.981	 5700.40.00	KZIZ - 3	- Engine code: OM364 - Engine code: OM354, OM364		
VARIO Bus		09.96 -				
O 812 (670.373, 670.674) O 814 (670.373, 670.374)	09.96 -	OM 602.984	 3620.90.02	362 18 MF362	- Engine code: OM904LA	
		OM 602.985	 3606.20.00	362WGTTB		
		OM 904.908	 3627.30.00			
			 3606.20.00	362 MF362	- Engine code: OM904LA	
			 8540.40.00	KZIS-4	- Engine code: OM904LA	
O 815 (670.373, 670.374)	09.96 -	OM 904.923	 3627.30.00	362 18 362WGTTB	- Engine code: OM904LA	
			 3620.90.02	362 18 MF362	- Equipment Var: Medio 815	
			 3606.20.00  3627.30.00	362WGTTB		
			 8540.40.00	KZIS-4	- Equipment Var: Medio 815	
SPRINTER 3,5-t Bus (906)		06.06 -				
318 CDI (906.731, 906.733, 906.735) 318 CDI 4x4 (906.731, 906.733, 906.735) 319 CDI / BlueTEC (906.731, 906.733, 906.735) 319 CDI / BlueTEC 4x4 (906.731, 906.733, 906.735)	02.08 - 12.09	OM 642.896	 2665.30.00 *	260 26 260 CTD		
	02.08 - 12.09	OM 642.898				
	03.09 -	OM 642.992				
	03.09 -	OM 642.993				
316 (906.733, 906.735) 316 NGT (906.733, 906.735) 316 LGT 310 CDI (906.731, 906.733, 906.735) 311 CDI (906.731, 906.733, 906.735) 311 CDI 4x4 (906.731, 906.733, 906.735) 313 CDI (906.731, 906.733, 906.735) 313 CDI 4x4 (906.731, 906.733, 906.735) 315 CDI (906.731, 906.733, 906.735) 315 CDI 4x4 (906.731, 906.733, 906.735)	09.08 -	M 271.951	 2418.30.00	240 26 240CTB		
	09.08 -	OM				
	09.08 -	651.955				
	03.09 - 12.13	OM				
	06.06 - 12.09	651.956				
	02.08 - 12.09	OM 646.985				
	02.08 - 12.09	OM 646.989				
	08.11 - 05.16	OM 646.990				
	08.11 - 05.16					
	06.06 - 12.09					
	02.08 - 12.09					

Vehicle list

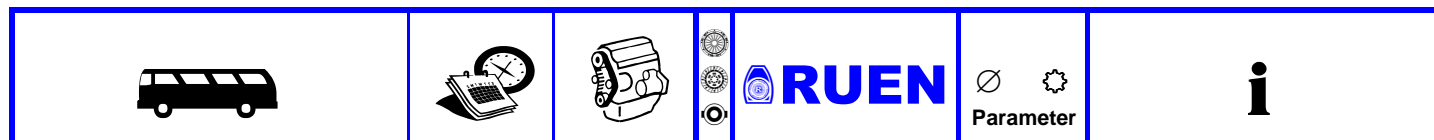

MERCEDES-BENZ

T1 Bus (601)		05.77 - 02.96			
208 2.3, 63kW 210 2.3, 70kW 210 2.3, 77kW	05.77 - 12.82 07.82 - 01.90 05.89 - 02.96	M 102.942 M 102.945 M 115.955 M 115.972	2150.90.06 2185.20.00 2159.30.00 3209.40.00	CP215 215CE KZAS - 1	- To chassis no.: 240087 - Chassis no.: 50001-556499
			2280.90.04 2282.20.00 2281.30.00 3214.40.00	228 10 M228KR 228PSD KZI/T - 1	- To chassis no.: 240087 - Chassis no.: 50001-556499
			2280.90.02 2282.20.00 2307.30.00 3214.40.00	228 10 M228KR 228CB KZI/T - 1	- From chassis no.: 5565600 - Chassis no.: 240088-499999
			2283.20.00	228 M228KR	- GBox: ZF
			3214.40.00	KZI/T - 1	
207 D 2.4, 48kW 207 D 2.4, 53kW	05.77 - 12.82 07.82 - 01.90	OM 616.917 OM 616.934	2280.90.02 2282.20.00 2307.30.00 3214.40.00	228 10 M228KR 228CB KZI/T - 1	- To chassis no.: 240084 - Chassis no.: 50001-556499 - GBox: ZF
			2150.90.06 2185.20.00 2159.30.00 3209.40.00	CP215 215CE KZAS - 1	- Chassis no.: 240085-499999 - Chassis no.: 556500-941505
			2280.90.03 2283.20.00 2306.30.00 3214.40.00	228 10 M228KR 228GSB KZI/T - 1	- Chassis no.: 240085-499999 - From chassis no.: 556500 - From chassis no.: 941506
			3214.40.00	KZI/T - 1	
208 D 2.3, 58kW 208 D 2.3, 60kW	10.88 - 02.96 10.88 - 02.96	OM 601.940	2280.90.02 2282.20.00 2307.30.00 3214.40.00	228 10 M228KR 228CB KZI/T - 1	- To chassis no.: 240084 - Chassis no.: 50001-556499 - To chassis no.: 240113 - GBox: ZF
			2150.90.06 2185.20.00 2159.30.00 3209.40.00	CP215 215CE KZAS - 1	- To chassis no.: 240084 - Chassis no.: 50001-556499 - To chassis no.: 240113
			2280.90.03 2283.20.00 2306.30.00 3214.40.00	228 10 M228KR 228GSB KZI/T - 1	- Chassis no.: 240085-499999 - From chassis no.: 556500 - To chassis no.: 941506
			2282.20.00	228 M228KR	- GBox: ZF
			2281.30.00	228 10 228PSD	- GBox: ZF
			3214.40.00	KZI/T - 1	- GBox: ZF
209 D 2.9, 65kW	12.82 - 01.90	OM 617.913	2280.90.03 2283.20.00 2306.30.00 3214.40.00	228 10 M228KR 228GSB KZI/T - 1	
			2282.20.00	228 M228KR	- GBox: ZF - For PTO
			2281.30.00	228 10 228PSD	- GBox: ZF - For PTO
			3214.40.00	KZI/T - 1	- GBox: ZF - For PTO

Vehicle list

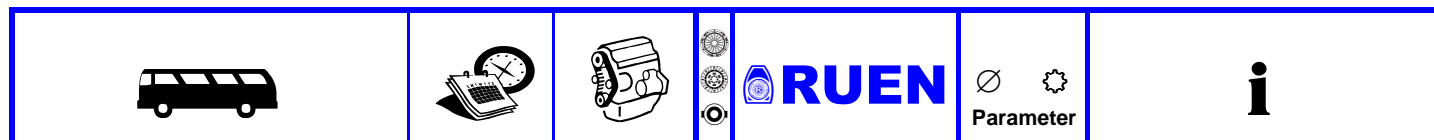

MERCEDES-BENZ

T1 Bus (601) 05.77 - 02.96

210 D 2.8, 70kW 210 D 2.8, 72kW	11.88 - 02.96 11.88 - 02.96	OM 602.940	2280.90.03	228 10 M228KR 228GSB KZI/T - 1	
			2283.20.00		
			2306.30.00		
			3214.40.00		
			2282.20.00	228 M228KR	- GBox: ZF - For PTO
			2281.30.00	228 10 228PSD	- GBox: ZF - For PTO
			3214.40.00	KZI/T - 1	- GBox: ZF - For PTO







T1 Bus (602) 04.77 - 02.96

308 D 2.3, 58kW	05.90 - 02.96	OM 601.940	2280.90.02	228 10 M228KR 228CB KZI/T - 1	- To chassis no.: 240084 - Chassis no.: 500001-556499 - To chassis no.: 240113
			2282.20.00		
			2307.30.00		
308 D 2.3, 60kW	06.89 - 02.96	OM 601.940	2280.90.03	228 10 M228KR 228GSB KZI/T - 1	- Chassis no.: 240085-499999 - From chassis no.: 556500
			2283.20.00		
			2306.30.00		
			2282.20.00	228 M228KR	- GBox: ZF - For PTO
			2281.30.00	228 10 228PSD	- GBox: ZF - For PTO
310 D 2.9, 70kW 310 D 2.9, 72kW	06.89 - 02.96 06.90 - 02.96	OM 602.940	2280.90.03	228 10 M228KR 228GSB KZI/T - 1	- From chassis no.: 941506
			2283.20.00		
			2306.30.00		
			3214.40.00		

Fahrgestell / Chassis









O 500 M 382.175, 382.186, 382.176 1725 382.186			4304.20.00	430 MFZ430	
			4306.30.00	430 10 430WGTZ	
O 500 R 634.001 1632 634.001			4304.20.00	430 MFZ430	
			4306.30.00	430 10 430WGTZ	
O 500 RS / 1836 634.011 O 500 RS / 2036 634.061 O 500 RS / 2242 634.071			4329.60.00 ⊕	430 MFZ430	
			4346.30.00	430 10 430WGTZ	
			4305.30.00	430 10 430W2GTZ	
			8918.40.00	KZISZ - 5	
1728 382.175 1732 382.176			4304.20.00	430 MFZ430	
			4306.30.00	430 10 430WGTZ	
			8951.40.00	KZISZ-5	

Vehicle list









					
---	---	---	--	---	---

MERCEDES-BENZ

811







LPO 811	10.69 - 02.73	OM 353.915	 2845.20.00	280 HVB280	- From engine no.: 393781
			 2822.30.00	280 10 280GTZ	- From engine no.: 393781
			 6909.40.00	KZI - 3	- To chassis no.: 4282707 - From engine no.: 393781
			 6908.40.00	KZ - 3	- Chassis no.: 4282708 - To engine no.: 678174
			 6901.40.00	KZI - 3	- From engine no.: 678175
			 3120.20.00	310 GFX310	- Chassis no.: 922885
			 3101.20.00	310 GFX310	- Chassis no.: 922886 - To engine no.: 393780
			 3124.30.00	310 10 310GSBL	- To engine no.: 393780

813

LPO 813	10.69 -	OM 353.904 OM 353.941 OM 353.965	 2845.20.00	280 HVB280	- From engine no.: 393781
			 2822.30.00	280 10 280GTZ	- From engine no.: 393781
			 6909.40.00	KZI - 3	- To chassis no.: 4282707 - From engine no.: 393781
			 6908.40.00	KZ - 3	- From model year: 4282708 - To engine no.: 678174
			 6901.40.00	KZI - 3	- From engine no.: 678175
			 3120.20.00	310 GFX310	- To chassis no.: 922885
			 3101.20.00	310 GFX310	- Chassis no.: 922886 - From chassis no.: 393780
			 3124.30.00	310 10 310GSBL	- From chassis no.: 393780









O 301

09.85 - 12.87







O 301, 100kW	06.86 - 05.87	OM 366.917	 3100.90.12	310 10 MF310 310WGSZ KZI - 3	
			 3164.20.00		
			 3136.30.00		
			 6901.40.00		
O 301, 125kW	02.86 - 05.87	OM 366.965	 3305.20.00	330 GMF330	
			 3325.30.00	330 10 330WGSZ	
			 6901.40.00	KZI - 3	

O 302























01.64 - 11.75

O 302			 2953.20.00	295 GF295	
			 2954.30.00	295 10 295BHZ	
			 6909.40.00	KZI - 3	- From chassis no.: 005442
			 3120.20.00	310 GFX310	- Chassis no.: 005442-025406
			 3101.20.00	310 GFX310	- To chassis no.: 025407
			 3124.30.00	310 10 310GSBL	- To chassis no.: 005442
			 3522.20.00	350 GF350KR	- From chassis no.: 002235 - From chassis no.: 797910
			 3588.30.00	350 10 350GSZ	
			 6915.40.00	KZI - 4	

Vehicle list

					
---	---	---	--	---	---

MERCEDES-BENZ

O 302		01.64 - 11.75						
O 302, 96kW	11.64 - 11.75	OM 352.980 OM 352.993	 2953.20.00	295 GF295	- Chassis no.: 005441			
			 3120.20.00	310 GFX310	- From chassis no.: 005442			
			 3124.30.00	310 10 310GSBL	- To chassis no.: 005442			
O 302, 125kW O 302, 141kW O 302, 154kW	05.69 - 12.74	OM 360.916 OM 360.979	 3522.20.00	350 GF350KR				
			 3588.30.00	350 10 350GSZ				
	05.69 - 12.74	OM 360.980 OM 360.981 OM 360.984 OM 360.985 OM 360.986						
O 302 Sonderausführung			 3522.20.00	350 GF350KR	- Special design - From chassis no.: 797910			
			 3588.30.00	350 10 350GSZ	- Special design			
			 6915.40.00	KZI - 4	- Special design			
O 303		10.74 - 09.92						
O 303			 4225.20.00	420 GF420KR				
			 4235.20.00	420 GF420KR				
			 4272.30.00	420 10 420WGSZ				
			 8511.40.00	KZI - 4,5	- From chassis no.: 39683 - From chassis no.: 036734			
			 8500.40.00	KZI - 4,5	- To chassis no.: 039682 - To model year: 036733			
			 4244.20.00	420 GFX420KR				
			 4278.30.00	420 10 420W2GSZ				
			 4304.20.00	430 MFZ430				
			 4306.30.00	430 10 430WGTZ				
			 8928.40.00	KZIZ - 5				
			O 303, 141kW, 12,8t O 303, 141kW, 14,4t O 303, 141kW, 16,00t	10.74 - 06.83	OM 401.907 OM 401.908	 3525.20.00	350 GF350KR	
						 3517.30.00	350 10 350WGSZ	
10.74 - 06.83	OM 401.912	 3575.30.00		350 10 350WGSZ				
		 8509.40.00		KZI - 4,5				

Vehicle list

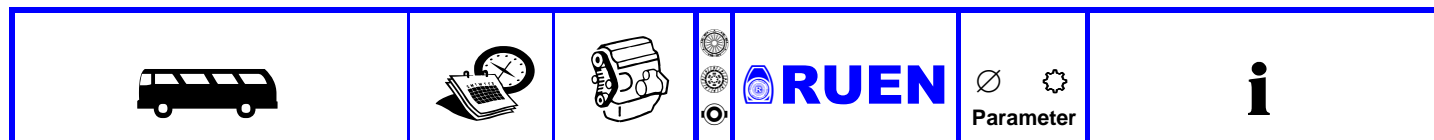

MERCEDES-BENZ

O 303		10.74 - 09.92			
O 303, 159kW, 16,00t O 303, 159/160kW, 14,4t	01.80 - 01.89 01.80 - 09.92	OM 421.908	3821.20.00	380 GF380KR	- Chassis no.: 053213
		OM 441.908	3857.30.00	380 10 380W2GSZ	- To chassis no.: 053213
		OM 441.909	8500.40.00	KZI - 4,5	- From chassis no.: 053214
		OM 441.911	8511.40.00	KZI - 4.5	- Chassis no.: 040653-053213 - From chassis no.: 053214
			4237.20.00	420 GF420KR	- To chassis no.: 053214
			4234.20.00	420 GF420KR	- From chassis no.: 053214
			4281.30.00	420 10 420WGVZ	- From chassis no.: 053214
			4300.90.18 4304.20.00 4316.30.00 8917.40.00	430 10 MFZ430 430WGTZ KZIZ - 5	
O 303, 159/160kW, 12,8t	01.80 - 09.92	OM 421.908	3821.20.00	380 GF380KR	- To chassis no.: 053213
		OM 441.911	3857.30.00	380 10 380W2GSZ	- Chassis no.: 053213
			8500.40.00	KZI - 4,5	- To chassis no.: ->053213 - To chassis no.: 053214->
			4237.20.00	420 GF420KR	- From chassis no.: 053214-
			4234.20.00	420 GF420KR	- From chassis no.: 053214->
			4281.30.00	420 10 420WGVZ	- From chassis no.: 053214->
O 303, 159/160kW, 17,00t	01.80 - 09.92	OM 421.908	3821.20.00	380 GF380KR	- To chassis no.: ->05323
		OM 441.908	3857.30.00	380 10 380W2GSZ	- To chassis no.: ->053213
		OM 441.909	8500.40.00	KZI - 4,5	- To chassis no.: ->053213 - To chassis no.: 053214->
			8511.40.00	KZI - 4.5	- Chassis no.: 040653-053213 - From chassis no.: 053214->
			4237.20.00	420 GF420KR	- From chassis no.: 053214->
			4234.20.00	420 GF420KR	- From chassis no.: 053214->
			4281.30.00	420 10 420WGVZ	- From chassis no.: 053214->
			4300.90.18 4304.20.00 4316.30.00 8917.40.00	430 10 MFZ430 430WGTZ KZIZ - 5	
O 303, 184kW, 14,40t O 303, 206kW, 16,00t	11.85 - 04.89 01.80 - 09.87	OM 421.951	4235.20.00	420 GF420KR	
		OM 422.908	4272.30.00	420 10 420WGSZ	
			8511.40.00	KZI - 4.5	
O 303, 188kW, 16,00t	03.75 - 06.83	OM 402.907	3821.20.00	380 GF380KR	
			3857.30.00	380 10 380W2GSZ	
			8500.40.00	KZI - 4,5	

Vehicle list

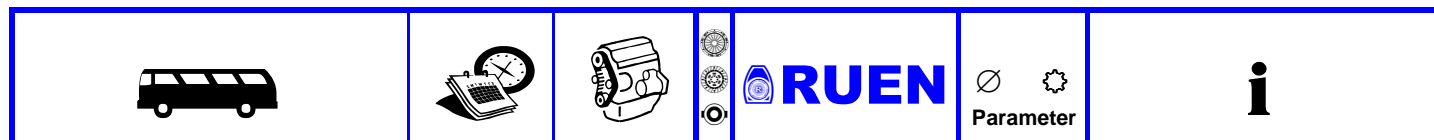

MERCEDES-BENZ

O 303 10.74 - 09.92

O 303, 200kW, 14,4t	12.87 - 09.92	OM 441.950 OM 441.953	4304.20.00	430 MFZ430	
			4306.30.00	430 10 430WGTZ	
			8928.40.00	KZIZ - 5	
O 303, 206kW, 17,00t	01.80 - 09.87	OM 422.908 OM 422.917	4225.20.00	420 GF420KR	- To chassis no.: 039683->
			4235.20.00	420 GF420KR	- To chassis no.: 039683->
			4272.30.00	420 10 420WGSZ	- From chassis no.: 039683->
			8500.40.00	KZI - 4,5	- To chassis no.: ->039682
			8511.40.00	KZI - 4.5	- To chassis no.: ->039683 - From chassis no.: 039683->
O 303, 213/218kW, 17,00t	09.87 - 09.92	OM 442.910 OM 442.911 OM 442.918 OM 442.939	4300.90.30	430 10 MFZ430	
			4305.20.00	430WGTZ	
			4304.30.00	KZIZ - 5	
			8917.40.00		
O 303, 235kW, 16,00t	07.75 - 06.83	OM 403.918	4225.20.00	420 GF420KR	
			4235.20.00	420 GF420KR	
			4272.30.00	420 10 420WGSZ	
			8500.40.00	KZI - 4,5	
O 303, 243kW, 17,00t	08.80 - 09.87	OM 422.951 OM 422.963	4244.20.00	420 GFX420KR	
			4278.30.00	420 10 420W2GSZ	
			8500.40.00	KZI - 4,5	- To chassis no.: ->036733
			8511.40.00	KZI - 4.5	- From chassis no.: 036734->
O 303, 260/269kW, 17,00t	09.87 - 09.92	OM 442.954 OM 442.955 OM 442.960 OM 442.961	4300.90.59	430 10 MFZ430	
			4304.20.00	430WGTZ	
			4346.30.00	KZIZ - 5	
			8928.40.00		

O 305 09.67 - 07.77

O 305			4222.20.00	420 GF420KR	
			4297.30.00	420 10 420GSZ	
			8500.40.00	KZI - 4,5	
O 305 G O 305 ST	02.78 - 05.87 02.79 - 05.87 04.73 - 07.77 01.70 - 05.73 11.76 - 05.87 04.73 - 07.77 11.76 - 05.87 02.79 - 05.87	OM 407.905 OM 407.908 OM 407.909 OM 407.910 OM 407.911 OM 407.913 OM 407.914 OM 407.917 OM 407.919 OM 407.951 OM 407.955	4222.20.00	420 GF420KR	
			4297.30.00	420 10 420GSZ	
			8500.40.00	KZI - 4,5	
O 305 VÖV			3831.30.00	380 10 380GSZ	- Engine code: OM360

Vehicle list

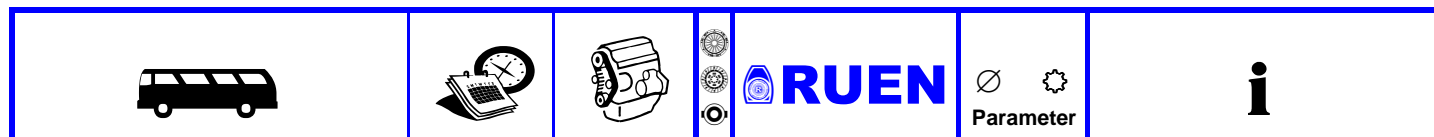

MERCEDES-BENZ







O 307 04.73 - 12.87

O 307				4222.20.00	420 GF420KR	- Chassis no.: ->000051
				4297.30.00	420 10 420GSZ	- To chassis no.: ->000051 - From chassis no.: 004703->
				8500.40.00	KZI - 4,5	- To chassis no.: ->000051 - Chassis no.: 000052-004702 - From chassis no.: 004703->
				3821.20.00	380 GF380KR	- Chassis no.: 000052-004702
				3821.30.00	380 10 380GSZ	- Chassis no.: 000052-004702
				4237.20.00	420 GF420KR	- From chassis no.: 004703->
				4234.20.00	420 GF420KR	- From chassis no.: 004703->
O 307	04.73 - 07.77 11.76 - 07.87 04.73 - 07.77 04.73 - 07.77 11.76 - 08.87	OM 407.905 OM 407.911 OM 407.915 OM 407.916 OM 407.918 OM 407.955		4222.20.00	420 GF420KR	
				4297.30.00	420 10 420GSZ	
				8500.40.00	KZI - 4,5	





























O 309 01.68 - 02.89

O 309				2282.20.00	228 M228KR	- From chassis no.: 018154->
				2306.30.00	228 10 228GSB	- Chassis no.: 018154-556499
				3214.40.00	KZI/T - 1	- From chassis no.: 028345-556499->
				2500.90.01	250 10	- From engine no.: 678175->
				2507.20.00	HBX250	
				2528.30.00	250BHZX	
				6901.40.00	KZI - 3	
				2507.20.00	250 HBX250	
				2528.30.00	250 10 250BHZX	
				6909.40.00	KZI - 3	- To chassis no.: ->018153
				6908.40.00	KZ - 3	- To engine no.: ->410747
				6901.40.00	KZI - 3	- From engine no.: 410748->
				2813.20.00	280 HVB280	
	2822.30.00	280 10 280GTZ	- To chassis no.: 346883->			

Vehicle list

					
---	---	---	--	---	---

MERCEDES-BENZ

O 309		01.68 - 02.89		
O 309 D 309.182, 309.183, 309.181, 309.190, 309.191, 309.173, 309.171, 309.172 O 309 D 323.382, 323.389, 323.386 O 309 D		2282.20.00	228 M228KR	- From chassis no.: 018154 - Engine code: OM615,616,621
		2306.30.00	228 10 228GSB	- From chassis no.: 018154 - To chassis no.: 556499 - Engine code: OM615,616,621
		3214.40.00	KZI/T - 1	- From chassis no.: 028345 - To chassis no.: 556499 - Engine code: OM615,616,621
		2500.90.01	250 10 HBX250	- From engine no.: 678175 - Engine code: OM314
		2507.20.00	250BHZX	
		2528.30.00	KZI - 3	
		6901.40.00		
		6909.40.00	KZI - 3	- Engine code: OM314 - To chassis no.: 018153 LHD, 018729 RHD
		6908.40.00	KZ - 3	- To engine no.: 410747 - Engine code: OM314
		2845.20.00	280 HVB280	- Engine code: OM353
	2822.30.00	280 10 280GTZ	- From chassis no.: 346883 - Engine code: OM353	
	2507.20.00	250 HBX250	- Engine code: OM314	
	2528.30.00	250 10 250BHZX	- Engine code: OM314	
O 311				
O 311		2812.20.00	280 HVB280	
		2812.30.00	280 10 280Z	
O 317		09.58 - 02.76		
O 317		3807.20.00	380 G380KR	- To engine no.: ->053185
		3822.30.00	380 10 380GSZ	
		8502.40.00	KZI - 4	
O 320				
O 320		3505.20.00	350 G350KR	- To chassis no.: ->3500318
		3552.30.00	350 10 350	- To chassis no.: ->3500318
O 321				
O 321 H,HL		2812.20.00	280 HVB280	- Special design
		2822.30.00	280 10 280GTZ	
		2812.30.00	280 10 280Z	- Special design
O 321 H,HL Sonderausführung		2812.20.00	280 HVB280	- Special design
		2812.30.00	280 10 280Z	- Special design
O 322				
O 322		2812.20.00	280 HVB280	
		2822.30.00	280 10 280GTZ	
O 322 Sonderausführung		2812.20.00	280 HVB280	
		2812.30.00	280 10 280Z	

Vehicle list

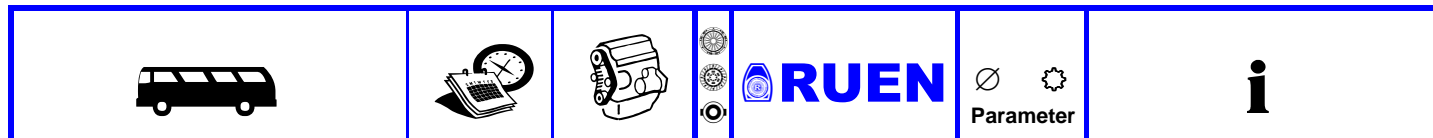

MERCEDES-BENZ

O 330

O 330 600.345	01.90 -	OM 442.939		4300.90.30	430 10	
O 330 600.445	01.90 -	OM 442.955 OM 442.961		4305.20.00 4304.30.00 8917.40.00	MFZ430 430WGTZ KZIZ - 5	

O 340 **01.91 - 06.95**

O 340	01.91 - 06.95	OM 441.994 OM 441.995		4304.20.00	430	
O 340, 250kW				4306.30.00	430 10	
				8928.40.00		KZIZ - 5
Tourismo	08.92 - 08.95	OM 402.984 OM 402.995		4300.90.59	430 10	
				4304.20.00 4346.30.00 8928.40.00	MFZ430 430WGTZ KZIZ - 5	

O 345 (CONECTO) **11.01 -**

O 345, Euro 1				4305.20.00	430		
O 345, Euro 2 671.000				4306.30.00	430 10		
				8928.40.00		KZIZ - 5	
CONECTO C, H, M, UE 671.030, 671.042, 671.015, 671.020, 671.021, 185kW	11.01 -	OM 457.942 OM 906.960		4304.20.00	430		
CONECTO C, H, UE 671.030, 671.042, 671.015, 671.020	11.01 -			4306.30.00	430 10		
CONECTO C, H, M, UE 671.030, 671.042, 671.015, 671.020, 671.021, 220kW	11.01 -			8928.40.00	KZIZ - 5	- For: OE Nr002 250 08 15	
CONECTO C, H, M, UE 671.030, 671.015, 671.020, 671.021, 671.942, 260kW	11.01 -			8905.40.00	KZIZ - 5	- For: OE Nr001 250 98 15	
				43460.30.00	430 10	- Engine code: OM457	
O 345, Euro 2 671.010				4305.20.00	430	- Engine code: OM 447 HLA	
				4306.30.00	430 10		- Engine code: OM 447 HLA
				8928.40.00		KZIZ - 5	- Engine code: OM 447 HLA

O 350 (TOURISMO) **09.94 -**

O 350 613.385, 613.355, 250kW				4304.20.00	430		
				4306.30.00	430 10		
				8905.40.00		KZIZ - 5	
				8928.40.00		KZIZ - 5	- For: Countri Version-Turkey
O 350 613.455, 613.485, 280kW				4300.90.01	430 10		
				4304.20.00 4346.30.00 8905.40.00		MFZ430 430WGTZ KZIZ - 5	
				4300.90.59	430 10	- For: Countri Version-Turkey	
				4304.20.00 4346.30.00 8928.40.00	MFZ430 430WGTZ KZIZ - 5		

Vehicle list

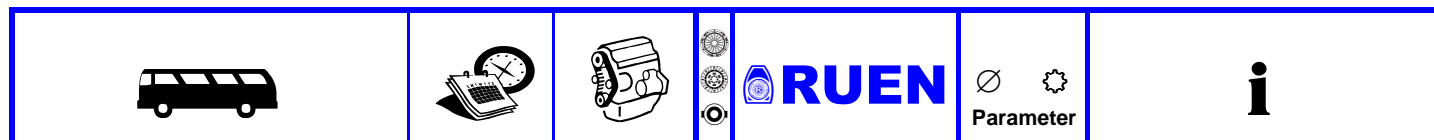

MERCEDES-BENZ

O 350 (TOURISMO) 09.94 -

Tourismo 613.455	08.95 -	OM 446.938	4304.20.00	430 MFZ430	
			4306.30.00	430 10 430WGTZ	
			8935.40.00	KZISZ - 5	
			8928.40.00	KZIZ - 5	
			43460.30.00	430 10 430WGTZ	- Equipment Var: SA504902-02
Tourismo RHD, SHD 613.388, 613.358, 260kW Tourismo RHD, SHD 613.388, 613.358, 310kW	09.03 - 09.03 -	OM 457.944	4304.20.00	430 MFZ430	- GBox: 714.140
			4307.20.00	430 MFZ430	- For: OE Nr 004 250 89 04
			4305.30.00	430 10 430W2GTZ	- GBox: 714.140
			4306.30.00	430 10 430WGTZ	- For: OE Nr. 018 250 94 03
			8928.40.00	KZIZ - 5	- For: OE Nr. 002 250 08 15
			8905.40.00	KZIZ - 5	- For: OE Nr. 001 250 98 15
			43460.30.00	430 10 430WGTZ	- Equipment Var: SA504902-02
Tourismo RHD 632.035, 632.037, 632.036, 632.038			4307.20.00	430 MFZ430	- Engine code: OM457
			43461.30.00	430 10 430WGTZ	- Engine code: OM457
			8944.40.00	KZIZ-5	- Engine code: OM457
Tourismo 15 RHD 632.036 Tourismo 15 SHD Tourismo 16 RHD 632.038 Tourismo 16 RHD 632.035, 632.038 Tourismo 16 RHD 632.035 Tourismo 16 RHD 632.035, 315kW Tourismo 16 RHD 632.035 Tourismo 17 RHD	01.03 - 01.03 - 01.03 - 01.03 - 01.03 - 01.03 - 01.03 - 01.03 - 01.03 - 01.03 - 01.03 - 01.03 - 01.03 - 01.03 -	OM 457.965 OM 457.961 OM 457.941 OM 457.944 OM 457.952 OM 457.953 OM 457.961 OM 457.965 OM 542.948 OM 542.966	4300.90.180	430 10	- Only install together
			43100.20.00	MFZ430E	
			4346.30.00	430WGTZ	
			8939.40.00	KZISZ - 5	

O 402 10.85 - 12.91

O 402 697.051, 100kW	02.86 - 12.91	OM 366.917	3100.90.12	310 10 MF310	
			3164.20.00	310WGSZ	
			3136.30.00	KZI - 3	
O 402 697.056, 125kW	02.86 - 12.91	OM 366.965	3305.20.00	330 GMF330	
			3325.30.00	330 10 330WGSZ	
			6901.40.00	KZI - 3	

Vehicle list

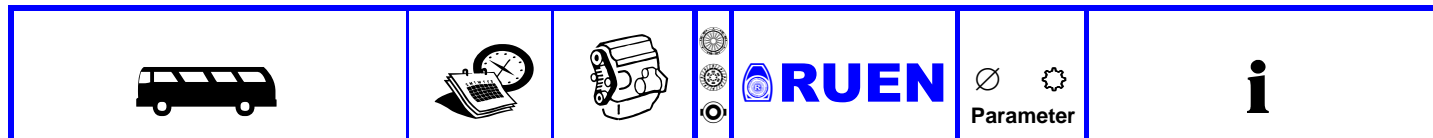

MERCEDES-BENZ

O 403







O 403 613.385, 613.355 O 403 - RHD E3 613.385, 613.355			4300.90.59	430 10	- For: Countri Version- Turkey
			4304.20.00	MFZ430	
			4346.30.00	430WGTZ	
			8928.40.00	KZIZ - 5	
			4304.20.00	430	- For: Turkey
				MFZ430	
			4306.30.00	430 10	- For: Turkey
				430WGTZ	
			8935.40.00	KZISZ - 5	- For: Turkey

O 404































09.91 - 10.99

O 404			4300.90.18	430 10		
			4304.20.00	MFZ430		
			4316.30.00	430WGTZ		
			8917.40.00	KZIZ - 5		
				4307.20.00	430	
					MFZ430	
			4332.30.00	430 10		
				430GTZ		
			4306.30.00	430 10		
				430WGTZ		
			8928.40.00	KZIZ - 5		
O 404, 151kW, 14,5t O 404, 165kW, 14,5t	09.91 - 01.92	OM 441.921	4307.20.00	430		
	09.91 - 01.92	OM 441.922		MFZ430		
			4316.30.00	430 10		
				430WGTZ		
			8928.40.00	KZIZ - 5		
O 404, 195kW, 18,00t O 404, 213kW, 18,00t	09.91 - 01.92	OM 442.930	4300.90.30	430 10		
	09.91 - 01.92	OM 442.931	4305.20.00	MFZ430		
			4304.30.00	430WGTZ		
			8917.40.00	KZIZ - 5		
O 404, 200kW, 14,50t O 404, 213kW, 14,50t	09.91 - 10.99	OM 401.970	4305.20.00	430		
	09.91 - 10.99	OM 401.974		MFZ430		
			4306.30.00	430 10		
				430WGTZ		
			8928.40.00	KZIZ - 5		
O 404, 200kW, 18,00t O 404, 213kW, 18,00t	09.91 - 10.99	OM 401.970	4305.20.00	430		
	09.91 - 10.99	OM 401.974		MFZ430		
			4306.30.00	430 10		
				430WGTZ		
			8928.40.00	KZIZ - 5		
O 404, 250kW, 17,00t	09.91 - 10.99	OM 441.980 OM 445.934	4300.90.30	430 10	- To chassis no.: ->069374	
			4305.20.00	MFZ430		
			4304.30.00	430WGTZ		
			8917.40.00	KZIZ - 5		
			4306.30.00	430 10	- From chassis no.: 069375->	
				430WGTZ		
		4304.20.00	430			
			MFZ430			
			8928.40.00	KZIZ - 5		
			8935.40.00	KZISZ - 5		
O 404, 250kW, 18,00t	09.91 - 10.99	OM 441.980 OM 445.934	4304.20.00	430		
				MFZ430		
			4306.30.00	430 10		
				430WGTZ		
			8928.40.00	KZIZ - 5		
			8935.40.00	KZISZ - 5		







Vehicle list

					
---	---	---	--	---	---































MERCEDES-BENZ

O 404		09.91 - 10.99			
O 404, 280kW, 17,00t	09.94 - 10.99	OM 446.938	 4304.20.00	430 MFZ430	
			 4306.30.00	430 10 430WGTZ	
			 8928.40.00	KZIZ - 5	
O 404, 280kW, 18,00t	09.91 - 10.99	OM 402.970	 4300.90.59	430 10 MFZ430	
			 4304.20.00	430WGTZ	
			 4346.30.00	KZIZ - 5	
			 8928.40.00		
			 8935.40.00	KZISZ - 5	
O 405		09.84 -			
O 405			 4244.20.00	420 GFX420KR	- GBox: DB 3/60-S4
			 4281.30.00	420 10 420WGVZ	
			 8511.40.00	KZI - 4.5	
			 4279.30.00	420 10 420WGSZ	
			 4297.30.00	420 10 420GSZ	- GBox: DB 3/60-S4
			 8500.40.00	KZI - 4,5	- GBox: DB 3/60-S4
			 4278.30.00	420 10 420W2GSZ	- Special design
O 405 G,O 405 GN,O 405 GTD	11.85 -	OM 427.911 OM 447.907 OM 447.955 OM 447.959 OM 447.976 OM 447.978	 4244.20.00	420 GFX420KR	
			 4284.30.00	420 10 420WGSZ	
			 8511.40.00	KZI - 4.5	
O 405 ST,O 405 N O 405 ST	12.84 -	OM 427.905 OM 427.950	 4244.20.00	420 GFX420KR	
			 4279.30.00	420 10 420WGSZ	
	11.85 -	OM 447.905 OM 447.911 OM 447.913 OM 447.914 OM 447.950 OM 447.951 OM 447.970 OM 447.973	 4284.30.00	420 10 420WGSZ	
			 4297.30.00	420 10 420GSZ	
			 8500.40.00	KZI - 4,5	
			 8511.40.00	KZI - 4.5	
O 405 ST,O 405 N	11.85 -	OM 427.910 OM 427.911 OM 447.907 OM 447.908 OM 447.910 OM 447.956 OM 447.957 OM 447.971 OM 447.974	 4244.20.00	420 GFX420KR	
			 4279.30.00	420 10 420WGSZ	
			 4284.30.00	420 10 420WGSZ	
			 4297.30.00	420 10 420GSZ	
			 8500.40.00	KZI - 4,5	
			 8511.40.00	KZI - 4.5	

Vehicle list

					
---	---	---	--	---	---

MERCEDES-BENZ

O 407		03.87 - 11.01				
O 407 357.100, 357.110				4244.20.00	420 GFX420KR	
				4279.30.00	420 10 420WGSZ	
				8511.40.00	KZI - 4.5	
				4254.20.00	420 GF420X	- Special design
				4235.20.00	420 GF420KR	- Special design
O 407 357.100, 357.110, 612.110, 612.116, 177/184kW	03.87 - 11.01	OM 447.906 OM 447.908 OM 447.954 OM 447.990		4244.20.00	420 GFX420KR	
				4284.30.00	420 10 420WGSZ	
				8511.40.00	KZI - 4.5	
				4297.30.00	420 10 420GSZ	
				4258.30.00	420 10 420GSZ	
O 407 357.120, 612.126, 357.130, 612.120, 220kW	11.91 - 11.01	OM 447.985 OM 447.991		4244.20.00	420 GFX420KR	
				4258.30.00	420 10 420GSZ	- For: TELMA-Bremse
				4278.30.00	420 10 420W2GSZ	- Not for chassis no.: TELMA-Bremse
				8511.40.00	KZI - 4.5	
O 408		09.89 - 12.98				
O 408 357.160, 357.150, 612.216, 184kW	01.91 - 12.98	OM 447.912 OM 447.958 OM 447.992		4244.20.00	420 GFX420KR	
				4284.30.00	420 10 420WGSZ	
				8511.40.00	KZI - 4.5	
				4297.30.00	420 10 420GSZ	
				4258.30.00	420 10 420GSZ	
O 408 357.180, 612.226, 357.170, 220kW	08.92 - 12.98	OM 447.987 OM 447.993		4244.20.00	420 GFX420KR	
				4258.30.00	420 10 420GSZ	- For: TELMA-Bremse
				4278.30.00	420 10 420W2GSZ	
				8511.40.00	KZI - 4.5	
O 408 357.180, 612.226, 357.160, 357.150, 612.216				4244.20.00	420 GFX420KR	
				4279.30.00	420 10 420WGSZ	
				8511.40.00	KZI - 4.5	
				4281.30.00	420 10 420WGVZ	
				4278.30.00	420 10 420W2GSZ	
O 510 (TOURINO)		10.03 -				
TOURINO 444.203, 444.200	10.03 -	OM 906.961		3951.20.00	395 MF395	
	10.03 -	OM 906.962		3961.30.00	395 18 395GTZ	
TOURINO 444.303, 444.300	10.03 -	OM 926.939		8540.40.00	KZIS-4	

Vehicle list

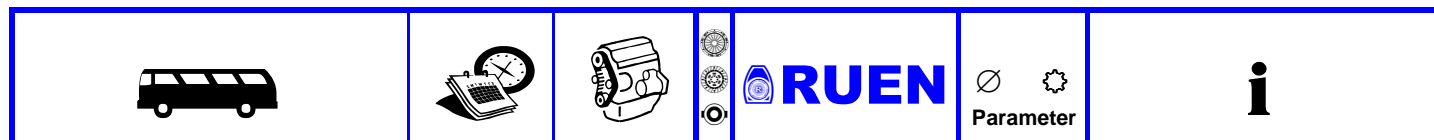

MERCEDES-BENZ

O 530 (CITARO) 01.98 -

Citaro N 628.147, 628.143, 628.148, 628.100, 628.145, 628.101, 205kW	01.99 -	OM 906.930 OM 906.960 OM 909.901 OM 909.921	4304.20.00	430 MFZ430	
			4306.30.00	430 10 430WGTZ	
Citaro N 628.001, 628.000, 170kW Citaro N 628.447, 628.040, 185kW	01.98 -	OM 457.934 OM 457.942	4304.20.00	430 MFZ430	
	01.98 -	OM 906.931 OM 909.900 OM 909.911	4305.30.00	430 10 430W2GTZ	
			8928.40.00	KZIZ - 5	
			8905.40.00	KZIZ - 5	
Citaro N 628.043, 628.050, 628.040, 628.045, 180kW	04.99 -	OM 906.962 OM 906.963	4304.20.00	430 MFZ430	
			4306.30.00	430 10 430WGTZ	
Citaro N 628.001, 628.043, 628.047, 628.050, 628.447, 628.000, 628.002, 628.040, 628.045, 628.048, 205kW	01.98 -	OM 906.930 OM 906.960 OM 906.961 OM 909.901 OM 909.921	4304.20.00	430 MFZ430	- Chassis no.: ->099808->
			4306.30.00	430 10 430WGTZ	
Citaro N, Citaro MUE 628.001, 628.447, 628.000, 628.040, 628.085, 628.083, 628.087, 628.080	01.98 -	OM 457.934 OM 457.942 OM 457.949 OM 457.950 OM 457.959 OM 457.973	4305.20.00	430 MFZ430	- Equipment Var: SA 504903-03 - To chassis no.: 099808
			4306.30.00	430 10 430WGTZ	- Equipment Var: SA 504902-07 - Engine code: OM 906 - Equipment Var: SA 504902-06
			8944.40.00	KZIZ-5	- Equipment Var: SA 504901-04, SA 504905-06/07, SA 504905-08/09
			8928.40.00	KZIZ - 5	- Equipment Var: SA 504901-02, SA 504905-05
			8905.40.00	KZIZ - 5	- Equipment Var: SA 504901-05
			4304.20.00	430 MFZ430	- Equipment Var: SA 504903-04 - From chassis no.: 099809
4347.30.00	430 10 430WGTZ	- Equipment Var: SA 504902-04			

O 550 (INTEGRO) 10.99 -

O 550			4300.90.57	430 10	- GBox: zf 6f-85
			4304.20.00	MFZ430	
			4316.30.00	430WGTZ	
			8935.40.00	KZISZ - 5	
			4307.20.00	430 MFZ430	- GBox: G04/160
			4306.30.00	430 10 430WGTZ	- GBox: G04/160
			8928.40.00	KZIZ - 5	- GBox: G04/160
			Integro, Integro M 633.001, 633.002, 220kW Integro, Integro M 633.001, 633.002, 260kW	01.06 -	OM 457.952 OM 457.964
01.06 -		43461.30.00		430 10 430WGTZ	- Engine code: OM 457 LA
		8944.40.00		KZIZ-5	- Engine code: OM 457 LA
		4300.90.180		430 10	- Engine code: OM 457 LA - Only install together
			43100.20.00	MFZ430E	
			4346.30.00	430WGTZ	
			8939.40.00	KZISZ - 5	
			Integro L Integro L Integro L 633.004 Integro M Integro 12M	01.06 -	OM 457.952
01.06 -		43100.20.00		MFZ430E	
		4346.30.00		430WGTZ	
		8939.40.00		KZISZ - 5	

Vehicle list

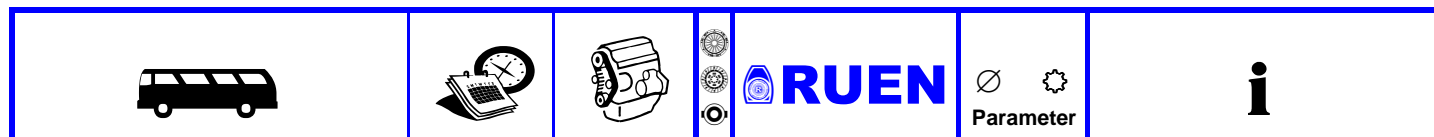

MERCEDES-BENZ

INTOURO 01.05 -

Intouro, Intouro E, Intouro M, Intouro ME 633.052, 633.251, 633.051, 633.252, 210kW	01.05 -	OM 457.965 OM 926.939		3951.20.00	395 MF395	
Intouro, Intouro E, Intouro M, Intouro ME 633.052, 633.251, 633.051, 633.252, 220kW	01.05 -			8540.40.00	KZIS-4	
Intouro, Intouro E, Intouro M, Intouro ME 633.052, 633.251, 633.051, 633.252, 260kW	01.05 -					
Intouro, Intouro E, Intouro M, Intouro ME 633.052, 633.251, 633.051, 633.252	01.05 -					

O 580 (TRAVEGO) 10.99 -

O 580-15 RH/RHD, 260kW	10.99 -	OM 457.936		4307.20.00	430 MFZ430	
O 580-15 RH/RHD, 300kW	10.99 -	OM 457.938		4306.30.00	430 10 430WGTZ	
O 580-15 RHD, 310kW	10.99 -	OM 457.940		4300.90.180	430 10 MFZ430E 430WGTZ KZISZ - 5	- Only install together
				43100.20.00		
				4346.30.00		
				8939.40.00		
				43460.30.00	430 10 430WGTZ	
O 580-17 RHD, 310kW	10.99 -	OM 457.944		4307.20.00	430 MFZ430	
O 580-17 RHD, 320kW	10.99 -	OM 542.948		4306.30.00	430 10 430WGTZ	
O 580-17 RHD, 350kW	10.99 -			43460.30.00	430 10 430WGTZ	
Travego 632.007, 629.015, 632.006, 632.012, 632.005, 632.010 Travego L Travego M	01.05 - 01.05 -			4300.90.180	430 10 MFZ430E 430WGTZ KZISZ - 5	- Only install together
				43100.20.00		
				4346.30.00		
				8939.40.00		
				8944.40.00	KZIZ-5	
O 580-16 RHD 629.015		OM 457.944 OM 542.948		4300.90.180	430 10 MFZ430E 430WGTZ KZISZ - 5	- Only install together
				43100.20.00		
				4346.30.00		
				8939.40.00		

O 608

LPO 608	10.69 - 10.77	OM 314.910 OM 314.944		2500.90.01	250 10 HBX250 250BHZX KZI - 3	- From engine no.: 410748->
				2507.20.00		
				2528.30.00		
				6901.40.00		
				6909.40.00	KZI - 3	- To chassis no.: ->4282707
				6908.40.00	KZ - 3	- From chassis no.: 4282708-> - To engine no.: ->410747

O 609

O 609 D	07.87 - 12.92	OM 364.913		2837.20.00	280 MFZ280	
				2822.30.00	280 10 280GTZ	
				5700.40.00	KZIZ - 3	

O 611

O 611 D	07.87 - 12.92	OM 364.952 OM 364.954		3176.20.00	310 MFZ310	
				3126.30.00	310 10 310GSBL	
				5700.40.00	KZIZ - 3	

Vehicle list

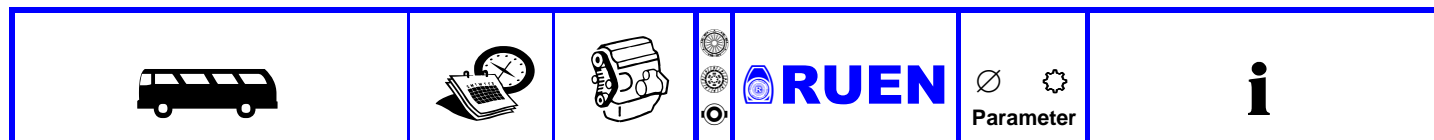

MERCEDES-BENZ

O 614

O 614 D	07.87 - 12.92	OM 364.980 OM 364.981	3176.20.00	310 MFZ310	
			3126.30.00	310 10 310GSBL	
			5700.40.00	KZIZ - 3	

O 709

LPO 709	11.77 - 12.84	OM 314.910 OM 314.944	2500.90.01	250 10 HBX250	- From engine no.: 678175->
			2507.20.00	250BHZX	
			2528.30.00	KZI - 3	
			6901.40.00		
			6909.40.00	KZI - 3	- To chassis no.: ->4282707
			6908.40.00	KZ - 3	- From chassis no.: 4282708-> - To engine no.: ->678174

O 812

O 812 D Vario	01.96 -	OM 602.984 OM 602.985	3620.90.02	362 18 MF362	
			3606.20.00	362WGTB	
			3627.30.00		

O 814

O 814	09.96 -	OM 904.908	3620.90.02	362 18 MF362	
			3606.20.00	362WGTB	
			3627.30.00		
O 814, O 814 L	01.84 - 12.98	OM 354.921	3164.20.00	310 MF310	
			6901.40.00	KZI - 3	
814 O, 814 LO	01.84 - 12.98	OM 356.906 OM 366.932	3100.90.12	310 10 MF310	
			3164.20.00	310WGSZ	
			3136.30.00	KZI - 3	
			6901.40.00		
			3300.90.04	330 10 GFM330	
			3300.20.00	330WGSZ	
			3325.30.00	KZI - 3	
			6901.40.00		







O 817

817 LO	03.96 - 12.98	OM 904.907	3620.90.01	362 18 MF362	
			3606.20.00	362WGTB	
			3627.30.00	KZIS-4	
			8536.40.00		
817 O, 817 LO	01.84 - 12.98	OM 356.948 OM 357.917 OM 366.969	3305.20.00	330 GMF330	
			3325.30.00	330 10 330WGSZ	
			6901.40.00	KZI - 3	

O 914





O 914			3100.90.12	310 10 MF310	
			3164.20.00	310WGSZ	
			3136.30.00	KZI - 3	
			6901.40.00		
			3300.90.04	330 10 GFM330	
			3300.20.00	330WGSZ	
			3325.30.00	KZI - 3	
			6901.40.00		

Vehicle list







					
---	---	---	--	---	---

MERCEDES-BENZ





O 1114

O 1114 ,O 1114 L	01.84 - 12.98	OM 356.907 OM 366.933	 3100.90.12  3164.20.00  3136.30.00  6901.40.00	310 10 MF310 310WGSZ KZI - 3	
------------------	---------------	--------------------------	--	--	--



O 1117

1117 LO	03.96 - 12.98	OM 904.907	 3620.90.01  3606.20.00  3627.30.00  8536.40.00	362 18 MF362 362WGTE KZIS-4	
1117 O,1117 LO	01.84 - 12.98	OM 356.949 OM 357.919 OM 366.971	 3580.20.00	350 GMF350	
			 3517.30.00	350 10 350WGSZ	
			 8529.40.00	KZI - 4,5	

O 1120

1120 O,1120 LO	01.84 - 12.98	OM 356.993 OM 357.929 OM 366.993	 3580.20.00	350 GMF350	
			 3583.30.00	350 10 350GSZ	
			 8529.40.00	KZI - 4,5	
			 3822.20.00	380 GF380KR	
			 3821.30.00	380 10 380GSZ	



O 3500

O 3500 ,S			 2812.20.00	280 HVB280	
			 2812.30.00	280 10 280Z	

O 5500







O 5500			 3552.30.00	350 10 350	
--------	--	--	---	----------------------	--

O 6600

O 6600			 3505.20.00	350 G350KR	- From chassis no.: 0154/54->
			 3552.30.00	350 10 350	

OF-Serie

01.83 -

OF 1113			 3101.20.00	310 GFX310	
			 3126.30.00	310 10 310GSBL	
			 6909.40.00	KZI - 3	
OF 1113 (358)			 2812.20.00	280 HVB280	
			 2813.30.00	280 10 280BHZ	
OF 1113 B			 3120.20.00	310 GFX310	
			 3124.30.00	310 10 310GSBL	

Vehicle list

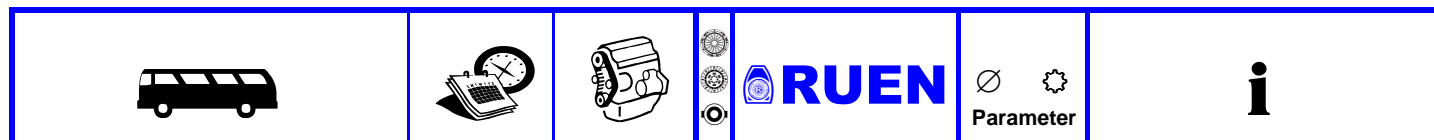

MERCEDES-BENZ







OF-Serie 01.83 -

OF 1313		3120.20.00	310 GFX310	- To chassis no.: ->922885
		3101.20.00	310 GFX310	- From chassis no.: 922886->
		3124.30.00	310 10 310GSBL	
		6909.40.00	KZI - 3	
		2954.20.00	295 GF295	
		2954.30.00	295 10 295BHZ	
OF 1317		3522.20.00	350 GF350KR	- From chassis no.: 797910->
		3588.30.00	350 10 350GSZ	
		6915.40.00	KZI - 4	
OF 1413		3120.20.00	310 GFX310	- To chassis no.: -.922885
		3101.20.00	310 GFX310	- From chassis no.: 922886->
		3124.30.00	310 10 310GSBL	
		6909.40.00	KZI - 3	
OF 1417		3588.30.00	350 10 350GSZ	- To chassis no.: ->797909
		6915.40.00	KZI - 4	- To chassis no.: ->797909
		3522.20.00	350 GF350KR	- From chassis no.: 797910->
OF 1617		3522.20.00	350 GF350KR	- From chassis no.: 797910->
		3588.30.00	350 10 350GSZ	
		6915.40.00	KZI - 4	
OF 1621		3822.20.00	380 GF380KR	

OH-Serie













OH 1416		3500.90.11	350 10	
		3580.20.00	GMF350	
		3583.30.00	350GSZ	
		8529.40.00	KZI - 4,5	
OH 1417		3580.20.00	350 GMF350	
		3583.30.00	350 10 350GSZ	
		3517.30.00	350 10 350WGSZ	- Only install together
		8529.40.00	KZI - 4,5	
OH 1622 ,L		3821.20.00	380 GF380KR	- To chassis no.: ->6901320 - To chassis no.: ->5418584
		3888.30.00	380 10 380WGSZ	- To chassis no.: 6901320 - To chassis no.: 5418584
		4226.20.00	420 GF420KR	- From chassis no.: 6901321-> - From chassis no.: 5418585->
		4234.20.00	420 GF420KR	
		4281.30.00	420 10 420WGVZ	- From chassis no.: 6901321-> - From chassis no.: 5418585->
		8511.40.00	KZI - 4,5	

Vehicle list







					
---	---	---	--	---	---

MERCEDES-BENZ

OH-Serie

OH 1625 ,L OH 1628 ,L				4225.20.00	420 GF420KR	
				4235.20.00	420 GF420KR	
				4272.30.00	420 10 420WGSZ	
				8511.40.00	KZI - 4.5	
OH 1627 L				4300.90.30	430 10 MFZ430	
				4305.20.00	430WGTZ	
				4304.30.00	KZIZ - 5	
				8917.40.00		
OH 1634 L				4300.90.01	430 10 MFZ430	- To chassis no.: ->Z 902592 - To chassis no.: ->K 017131
				4304.20.00	430 MFZ430	- From chassis no.: Z 902593-> - From chassis no.: K 017132->
				4306.30.00	430 10 430WGTZ	- From chassis no.: Z 902593-> - From chassis no.: K 017132->
				8928.40.00	KZIZ - 5	- From chassis no.: Z 902593 - From chassis no.: K 017132->

OP 311 - OP 330

OP 311				2812.20.00	280 HVB280	
				2812.30.00	280 10 280Z	
OP 312				2812.20.00	280 HVB280	
				2822.30.00	280 10 280GTZ	
OP 315 OP 330				3505.20.00	350 G350KR	
				3552.30.00	350 10 350	

V-Class (638/2)

V 230 (638.234) (Mot.M 111.978)	10.96 - 07.03			2400.90.05		
---------------------------------	---------------	--	---	-------------------	--	--

SPRINTER 3-t Bus (906)



06.06 -

216 (906.713)	09.08 -	M		2418.30.00	240 26 240CTB	
211 CDI (906.711, 906.713)	06.06 - 12.09	271.951				
213 CDI (906.711, 906.713)	06.06 - 05.15	OM				
215 CDI (906.711, 906.713)	06.06 - 12.09	651.955				
218 CDI (906.711, 906.713)	06.06 -	OM				
		651.956				
		OM 646.985				
		OM 646.986				
		OM 646.989				
		OM 646.990				
		OM 651.957				

NEOPLAN

Centroliner

10.98 -

Centroliner N 4426/3L				4301.20.00	430 MFZ430	- GBox: ZF 5 HP602
				4300.30.00	430 10 430GTZ	- GBox: ZF 5 HP 602
				8935.40.00	KZISZ - 5	- GBox: ZF 5 HP 602

Vehicle list

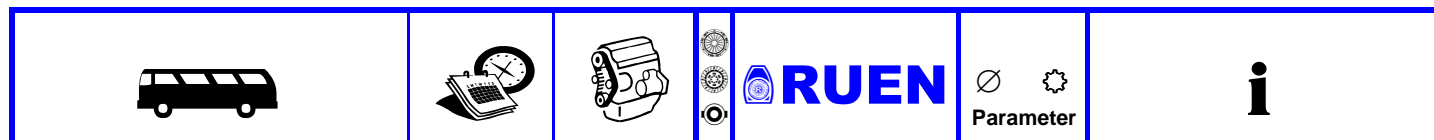







NEOPLAN

Cityliner 04.73 -























Cityliner				4255.30.00	420 10 420GS	
				4225.20.00	420 GF420KR	
				4235.20.00	420 GF420KR	
				4208.30.00	420 10 420GS	
				4244.20.00	420 GFX420KR	
				4278.30.00	420 10 420W2GSZ	
				8515.40.00	KZI - 4,5	
				3893.10.00	380 GF2/380	- This part number includes one clutch disc
				3891.30.00	380 10 380GS	- Loose clutch disc
				3882.20.00	380 GF2/380	- Contained in xxxx.10.00
				3882.50.00	380 GF2/380	- Contained in xxxx.10.00
				3889.30.00	380 10 380GSZ	- Contained in xxxx.10.00
Cityliner N 1116				4301.20.00	430 MFZ430	- GBox: ZF 8S-180 - GBox: ZF AS-Tronic
				4300.30.00	430 10 430GTZ	- GBox: ZF 8S-180 - GBox: ZF AS-Tronic
				8935.40.00	KZISZ - 5	- GBox: ZF 8S-180 - GBox: ZF AS-Tronic
N 1216 HD N 1217 HD N 1218 HD	09.06 -	D 2066 LOH 03		4301.20.00	430 MFZ430	- Engine code: D2066 LOH 07/08/10, D2066 LOH 28/32 - Engine code: D2676 LOH 10/26/30 - GBox: GO 210-6
				4347.30.00	430 10 430WGTZ	- Engine code: D2066 LOH 07/08/10, D2066 LOH 28/32, - Engine code: D2676 LOH 10/26/30 - GBox: GO 210-6
				8944.40.00	KZIZ-5	- Engine code: D2066 LOH 07/08/10, D2066 LOH 28/32, - Engine code: D2676 LOH 10/26/30 - GBox: GO 210-6
				4300.90.56	430 10 MFZ430	- Engine code: D2066 LUH09/24/34/53, D2066 LOH 07/08/10
				4319.20.00	430WGTZ	- Engine code: D2066 LOH 28/32, D2676 LOH 10/26/30
				4346.30.00	KZISZ - 5	- GBox: AS-Tronic
				8939.40.00		- Use release fork with rollers
	8919.40.00	KZISZ - 5	- Engine code: D2066 LUH09/24/34/53, D2066 LOH 07/08/10 - Engine code: D2066 LOH 28/32, D2676 LOH 10/26/30 - GBox: AS-Tronic - Use release fork with cam			
	4300.90.182 ■	430 10 MFZ430E	- Engine code: D2066 LOH07/08/10/28, D2066 LUH09/24/34			
	43100.20.00	430WGTZ	- GBox: ZF 6S			
	43134.30.00	KZIZ - 5	- Only install together			
	8916.40.00					

Vehicle list





					
---	---	---	--	---	---

NEOPLAN

























Cityliner 04.73 -

N 1216 HDC	09.06 -	D 2066 LOH 04	 4300.90.13	430 10	- Engine code: D2066LUH14/15/09, D2066LUH03/04/10, D2676LOH01/10
			 4319.20.00	MFZ430	- GBox: AS-Tronic
			 4346.30.00	430WGTZ	- Use release fork with cam
			 8919.40.00	KZISZ - 5	
			 4300.90.56	430 10	- Engine code: D2066LUH14/15/09, D2066LUH03/04/10, D2676LOH01/10
 4319.20.00	MFZ430	- GBox: AS-Tronic			
 4346.30.00	430WGTZ	- Use release fork with rollers			
 8939.40.00	KZISZ - 5				
 4300.90.105	430 10	- Engine code: D2676LOH02			
 4386.20.00	MFZ430	- GBox: AS-Tronic			
 4386.30.00	430WGTZ	- Use release fork with rollers			
 8939.40.00	KZISZ - 5				
 4300.90.180 	430 10	- Engine code: D2066LUH14/15/09, D2066LUH03/04/10, D2676LOH01/10			
 43100.20.00	MFZ430E	- GBox: GO-210-6			
 4346.30.00	430WGTZ	- Only install together			
 8939.40.00	KZISZ - 5				
 4300.90.185 	430 10	- Engine code: D2066LUH14/15/09, D2066LUH03/04/10, D2676LOH01/10			
 43100.20.00	MFZ430E	- GBox: ZF 6S-85			
 4356.30.00	430WGTZ	- Only install together			
 8916.40.00	KZIZ - 5				







Clubstar

Clubstar			 3100.90.12	310 10	
			 3164.20.00	MF310	
			 3136.30.00	310WGSZ	
			 6901.40.00	KZI - 3	

Euroliner 07.97 -













N 3313 U			 4301.20.00	430	- GBox: ZF 6S-1600
			 4300.30.00	MFZ430	- GBox: ZF 5 HP 602C
			 8935.40.00	430 10	- GBox: ZF 6S-1600
N 3316 KL, N 3316 ÜL		D 2866 LUH 25	 4300.30.00	430GTZ	- GBox: ZF 5 HP 602C
			 4301.20.00	430	- GBox: ZF 6S-1600
			 4300.30.00	MFZ430	- GBox: ZF 5HP-602
N 3316 Ü, N 3316 K		D 2866 LUH 30	 4300.30.00	430 10	- GBox: ZF AS-Tronic
			 8935.40.00	430GTZ	- GBox: ZF 6S-1600
			 4301.20.00	430	- GBox: ZF 5HP-602
N 3312 K / U			 4300.30.00	430GTZ	- GBox: ZF AS-Tronic
			 8935.40.00	KZISZ - 5	- GBox: ZF 6S-1600
			 4301.20.00	430	- GBox: ZF 5HP-602
N 3312 K / U			 4301.20.00	MFZ430	- GBox: ZF AS-Tronic
			 4300.30.00	430 10	- Engine code: OM 501 LA
			 8935.40.00	430GTZ	- GBox: ZF 6S-1600
N 3312 K / U			 4301.20.00	430	- Engine code: OM 501 LA
			 4300.30.00	MFZ430	- GBox: ZF 6S-1600
			 8935.40.00	430GTZ	- GBox: ZF AS-Tronic
N 3312 K / U			 4301.20.00	430	- Engine code: OM 501 LA
			 4300.30.00	MFZ430	- GBox: ZF 6S-1600
			 8935.40.00	430GTZ	- GBox: ZF AS-Tronic
N 3312 K / U			 4301.20.00	430	- Engine code: OM 501 LA
			 4300.30.00	MFZ430	- GBox: ZF 6S-1600
			 8935.40.00	430GTZ	- GBox: ZF AS-Tronic

Vehicle list









					
---	---	---	--	---	---

NEOPLAN













Jetliner 09.73 - 09.93

Jetliner		4255.30.00	420 10 420GS	
		4225.20.00	420 GF420KR	
		4235.20.00	420 GF420KR	
		4208.30.00	420 10 420GS	
N 209 Jetliner N 212 Jetliner		4300.90.56	430 10	- Engine code: D2066 LUH09/24/34/53, D2066 LOH07/08/10
		4319.20.00	MFZ430	- Engine code: D2066 LOH28/32, D2676 LOH10/26/30
		4346.30.00	430WGTZ	- GBox: AS-Tronic
		8939.40.00	KZISZ - 5	- Use release fork with rollers
		8919.40.00	KZISZ - 5	- Engine code: D2066 LUH09/24/34/53, D2066 LOH07/08/10
		4346.30.00	430 10 430WGTZ	- Engine code: D2066 LOH28/32, D2676 LOH10/26/30
		4346.30.00	430 10 430WGTZ	- Engine code: D2066 LOH06/12/27/31, D2066 LUH07/08/22/23
		4346.30.00	430 10 430WGTZ	- GBox: AS-Tronic
		4346.30.00	430 10 430WGTZ	- Use release fork with rollers







Megaliner 01.93 -

Megaliner		4255.30.00	420 10 420GS	
		4244.20.00	420 GFX420KR	
		4278.30.00	420 10 420W2GSZ	
		8515.40.00	KZI - 4,5	
		4010.10.00	400 MFZ2/400X	- This part number includes one clutch disc
		4021.30.00	400 10 400GVZ	- Loose clutch disc
		8935.40.00	KZISZ - 5	
		4020.30.00	400 10 400GVZ	- Contained in xxxx.10.00

Mot. DAF









Motor - DAF		4205.20.00	420 G420KR	
		4203.30.00	420 10 420GS	
		4255.30.00	420 10 420GS	
Motor - Daimler Chrysler		3821.20.00	380 GF380KR	
		3857.30.00	380 10 380W2GSZ	
		4225.20.00	420 GF420KR	
		4235.20.00	420 GF420KR	
		4258.30.00	420 10 420GSZ	
		4226.20.00	420 GF420KR	
		4234.20.00	420 GF420KR	
		4297.30.00	420 10 420GSZ	
		3821.30.00	380 10 380GSZ	

Vehicle list























					
---	---	---	--	---	---

NEOPLAN







Mot. DAF

Motor - Henschel		4205.20.00	420 G420KR	
		4203.30.00	420 10 420GS	
		3506.20.00	350 G350	
Motor - MAN		4225.20.00	420 GF420KR	
		4235.20.00	420 GF420KR	
		4258.30.00	420 10 420GSZ	
		3821.20.00	380 GF380KR	
		3857.30.00	380 10 380W2GSZ	
		4250.30.00	420 10 420WGSZ	

N 113 - N 116

















N 113		4301.20.00	430 MFZ430	
		4305.30.00	430 10 430W2GTZ	
		8935.40.00	KZISZ - 5	
N 116, 235kW		4200.90.17	420 10 GF420KR 420GSZ	
		4235.20.00	GF420KR	
		4258.30.00	420GSZ	
		8500.40.00	KZI - 4,5	
		4225.20.00	420 GF420KR	
		4272.30.00	420 10 420WGSZ	
		8500.40.00	KZI - 4,5	
		4244.20.00	420 GFX420KR	
N 116, 259kW		4278.20.00	420 GFX420KR	
		4253.20.00	420 GFX420KR	
		4257.30.00	420 10 420GSZ	
N 116, 280kW		4250.30.00	420 10 420WGSZ	
		4301.20.00	430 MFZ430	
		4305.30.00	430 10 430W2GTZ	
N 116, 384kW		8935.40.00	KZISZ - 5	
		4010.10.00	400 MFZ2/400X	- This part number includes one clutch disc
		4021.30.00	400 10 400GVZ	- Loose clutch disc
		8935.40.00	KZISZ - 5	
		4020.30.00	400 10 400GVZ	- Contained in xxxx.10.00

Vehicle list

















					
---	---	---	--	---	---

NEOPLAN







N 113 - N 116

N 116		4301.20.00	430 MFZ430	
		4305.30.00	430 10 430W2GTZ	
		8935.40.00	KZISZ - 5	
		4205.20.00	420 G420KR	
		4203.30.00	420 10 420GS	
		4200.90.17	420 10	
		4235.20.00	GF420KR	
		4258.30.00	420GSZ	
		8500.40.00	KZI - 4,5	
		4225.20.00	420 GF420KR	
		4272.30.00	420 10 420WGSZ	
		8500.40.00	KZI - 4,5	
		4256.20.00	420 GMF420K	
		4282.30.00	420 10 420WGVZ	
	4235.20.00	420 GF420KR		
	4209.30.00	420 10 420GS		

N 117 - N 120















N 117, 235kW N 120, 235kW		4200.90.17	420 10	
		4235.20.00	GF420KR	
		4258.30.00	420GSZ	
		8500.40.00	KZI - 4,5	
N 117, 259kW N 120, 259kW		4225.20.00	420 GF420KR	
		4272.30.00	420 10 420WGSZ	
		8500.40.00	KZI - 4,5	
N 117, 280kW N 118, 280kW		4253.20.00	420 GFX420KR	
		4257.30.00	420 10 420GSZ	
		4250.30.00	420 10 420WGSZ	
N 117, 280kW N 118, 280kW		4301.20.00	430 MFZ430	
		4305.30.00	430 10 430W2GTZ	
		8935.40.00	KZISZ - 5	
		4010.10.00	400 MFZ2/400X	- This part number includes one clutch disc
		4021.30.00	400 10 400GVZ	- Loose clutch disc
		4020.30.00	400 10 400GVZ	- Contained in xxxx.10.00

Vehicle list

















					
---	---	---	--	---	---

NEOPLAN







N 117 - N 120

N 117		4301.20.00	430 MFZ430	
		4305.30.00	430 10 430W2GTZ	
		8935.40.00	KZISZ - 5	
		4244.20.00	420 GFX420KR	
		4278.30.00	420 10 420W2GSZ	
		4256.20.00	420 GMF420K	
		4282.30.00	420 10 420WGVZ	
N 118		4301.20.00	430 MFZ430	
		4305.30.00	430 10 430W2GTZ	
		8935.40.00	KZISZ - 5	
		4256.20.00	420 GMF420K	
		4282.30.00	420 10 420WGVZ	
N 117, 384kW N 118, 384kW		4020.30.00	400 10 400GVZ	- Engine code: OM442LA
		4021.30.00	400 10 400GVZ	- Engine code: OM442LA
		8935.40.00	KZISZ - 5	- Engine code: OM442LA

N 121 - N 128













N 121, 235kW N 122, 235kW		4200.90.17	420 10	
		4235.20.00	GF420KR	
		4258.30.00	420GSZ	
		8500.40.00	KZI - 4,5	
		4225.20.00	420 GF420KR	
N 121, 259kW N 122, 259kW		4272.30.00	420 10 420WGSZ	
		8500.40.00	KZI - 4,5	
		4253.20.00	420 GFX420KR	
N 122, 280kW		4257.30.00	420 10 420GSZ	
		4250.30.00	420 10 420WGSZ	
		4301.20.00	430 MFZ430	
N 122, 384kW		4305.30.00	430 10 430W2GTZ	
		8935.40.00	KZISZ - 5	
		4010.10.00	400 MFZ2/400X	- This part number includes one clutch disc
		4021.30.00	400 10 400GVZ	- Loose clutch disc
		8935.40.00	KZISZ - 5	
		4020.30.00	400 10 400GVZ	- Contained in xxxx.10.00

Vehicle list





					
---	---	---	--	---	---

NEOPLAN











N 121 - N 128

N 122		4301.20.00	430 MFZ430	
		4305.30.00	430 10 430W2GTZ	
		8935.40.00	KZISZ - 5	
		4205.20.00	420 G420KR	
		4203.30.00	420 10 420GS	
		4253.20.00	420 GFX420KR	
		4257.30.00	420 10 420GSZ	
		4250.30.00	420 10 420WGSZ	
		3893.10.00	380 GF2/380	- This part number includes one clutch disc
		3882.20.00	380 GF2/380	- Contained in xxxx.10.00
		3882.50.00	380 GF2/380	- Contained in xxxx.10.00
		3889.30.00	380 10 380GSZ	- Contained in xxxx.10.00







N 138 - N 140

N 138, 259kW		4253.20.00	420 GFX420KR	
		4257.30.00	420 10 420GSZ	
		4250.30.00	420 10 420WGSZ	
N 138, 294kW		4244.20.00	420 GFX420KR	
		4278.30.00	420 10 420W2GSZ	

N 202 - N 209











N 202		3573.20.00	350 MF350	
		3563.30.00	350 10 350GSZ	
N 208		3573.20.00	350 MF350	
		3563.30.00	350 10 350GSZ	
		6905.40.00	KZIS - 3	
		3951.20.00	395 MF395	
		3951.30.00	395 10 395WGTZ	
		3120.20.00	310 GFX310	
		3124.30.00	310 10 310GSBL	
		3587.30.00	350 10 350GSZ	

Vehicle list





















					
---	---	---	--	---	---

NEOPLAN







N 202 - N 209

N 209		3525.20.00	350 GF350KR
		3583.30.00	350 10 350GSZ
		4235.20.00	420 GF420KR
		4258.30.00	420 10 420GSZ
		4200.90.17	420 10
		4235.20.00	GF420KR
		4258.30.00	420GSZ
		8500.40.00	KZI - 4,5
		4225.20.00	420 GF420KR
	4272.30.00	420 10 420WGSZ	
	8500.40.00	KZI - 4,5	

N 210 - N 213

















N 210		3120.20.00	310 GFX310
		3124.30.00	310 10 310GSBL
N 212		3506.20.00	350 G350
		3588.30.00	350 10 350GSZ
		3120.20.00	310 GFX310
		3124.30.00	310 10 310GSBL
		3525.20.00	350 GF350KR
		3583.30.00	350 10 350GSZ
		4235.20.00	420 GF420KR
		4258.30.00	420 10 420GSZ
		4200.90.17	420 10
		4235.20.00	GF420KR
		4258.30.00	420GSZ
		8500.40.00	KZI - 4,5
		4225.20.00	420 GF420KR
		4272.30.00	420 10 420WGSZ
		8500.40.00	KZI - 4,5
	4301.20.00	430 MFZ430	
	4305.30.00	430 10 430W2GTZ	
	8935.40.00	KZISZ - 5	

Vehicle list













					
---	---	---	--	---	---

NEOPLAN







N 210 - N 213

N 213		3506.20.00	350 G350	
		3588.30.00	350 10 350GSZ	
		3525.20.00	350 GF350KR	
		3583.30.00	350 10 350GSZ	
		4235.20.00	420 GF420KR	
		4258.30.00	420 10 420GSZ	
		4200.90.17	420 10 GF420KR	
		4235.20.00	420GSZ	
		4258.30.00	420GSZ	
		8500.40.00	KZI - 4,5	
		4225.20.00	420 GF420KR	
		4272.30.00	420 10 420WGSZ	
		8500.40.00	KZI - 4,5	
		4301.20.00	430 MFZ430	
	4305.30.00	430 10 430W2GTZ		
	8935.40.00	KZISZ - 5		

N 214 - N 216































N 214, 206kW		4200.90.17	420 10 GF420KR	
		4235.20.00	420GSZ	
		4258.30.00	420GSZ	
		8500.40.00	KZI - 4,5	
N 214, 235kW		4225.20.00	420 GF420KR	
		4272.30.00	420 10 420WGSZ	
		8500.40.00	KZI - 4,5	
		4200.90.17	420 10 GF420KR	
		4235.20.00	420GSZ	
		4258.30.00	420GSZ	
	8500.40.00	KZI - 4,5		
	4244.20.00	420 GFX420KR		
	4278.20.00	420 GFX420KR		

Vehicle list

					
---	---	---	--	---	---

NEOPLAN

N 214 - N 216

N 214		4205.20.00	420 G420KR
		4203.30.00	420 10 420GS
		3506.20.00	350 G350
		3588.30.00	350 10 350GSZ
		4301.20.00	430 MFZ430
		4305.30.00	430 10 430W2GTZ
		8935.40.00	KZISZ - 5
		4306.30.00	430 10 430WGTZ
N 216, 206kW		4200.90.17	420 10
		4235.20.00	GF420KR
		4258.30.00	420GSZ
		8500.40.00	KZI - 4,5
		4225.20.00	420 GF420KR
N 216, 235kW		4272.30.00	420 10 420WGSZ
		8500.40.00	KZI - 4,5
		4200.90.17	420 10
		4235.20.00	GF420KR
		4258.30.00	420GSZ
		8500.40.00	KZI - 4,5
		4225.20.00	420 GF420KR
		4272.30.00	420 10 420WGSZ
N 216, 280kW		8500.40.00	KZI - 4,5
		4253.20.00	420 GFX420KR
		4257.30.00	420 10 420GSZ
		4250.30.00	420 10 420WGSZ
		4244.20.00	420 GFX420KR
		4278.30.00	420 10 420W2GSZ
		4301.20.00	430 MFZ430
		4305.30.00	430 10 430W2GTZ
N 216, 280kW		8935.40.00	KZISZ - 5

Vehicle list

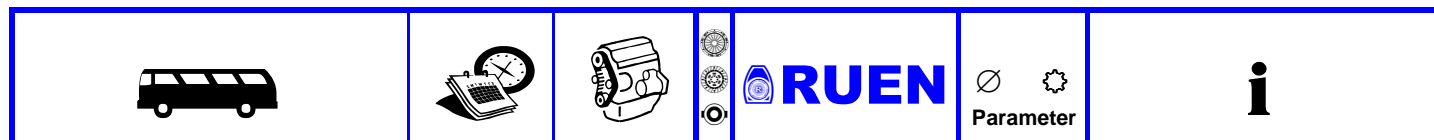

NEOPLAN

N 214 - N 216

N 216		4205.20.00	420 G420KR
		4203.30.00	420 10 420GS
		4235.20.00	420 GF420KR
		4209.30.00	420 10 420GS
		4301.20.00	430 MFZ430
		4305.30.00	430 10 430W2GTZ
		8935.40.00	KZISZ - 5
		4306.30.00	430 10 430WGTZ
		4225.20.00	420 GF420KR
		4231.30.00	420 10 420GSZ
		43460.30.00	430 10 430WGTZ

N 218 - N 220

N 218, 206kW		4200.90.17	420 10
		4235.20.00	GF420KR
		4258.30.00	420GSZ
		8500.40.00	KZI - 4,5
		4225.20.00	420 GF420KR
		4272.30.00	420 10 420WGSZ
		8500.40.00	KZI - 4,5

N 218, 235kW N 220, 235kW		4200.90.17	420 10
		4235.20.00	GF420KR
		4258.30.00	420GSZ
		8500.40.00	KZI - 4,5
		4225.20.00	420 GF420KR
		4272.30.00	420 10 420WGSZ
		8500.40.00	KZI - 4,5
		4244.20.00	420 GFX420KR
		4278.30.00	420 10 420W2GSZ

N 218, 259kW N 220, 259kW		4253.20.00	420 GFX420KR
		4250.30.00	420 10 420WGSZ
		4257.30.00	420 10 420GSZ

N 218		4205.20.00	420 G420KR
		4203.30.00	420 10 420GS

Vehicle list

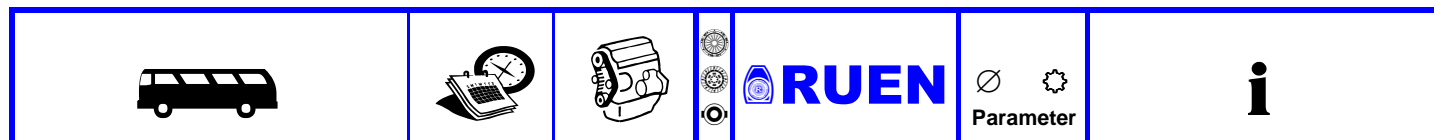







NEOPLAN

N 312 - N 314

















N 312		3506.20.00	350 G350
		3588.30.00	350 10 350GSZ
		3120.20.00	310 GFX310
		3124.30.00	310 10 310GSBL
		4301.20.00	430 MFZ430
		4305.30.00	430 10 430W2GTZ
		8935.40.00	KZISZ - 5
N 313		3525.20.00	350 GF350KR
		3583.30.00	350 10 350GSZ
		4225.20.00	420 GF420KR
		4235.20.00	420 GF420KR
		4258.30.00	420 10 420GSZ
N 313, 206kW		3506.20.00	350 G350
		3588.30.00	350 10 350GSZ
		4200.90.17	420 10 GF420KR
		4235.20.00	420GSZ
		4258.30.00	KZI - 4,5
		8500.40.00	
		4225.20.00	420 GF420KR
N 314		4272.30.00	420 10 420WGSZ
		8500.40.00	KZI - 4,5
		4205.20.00	420 G420KR
		4203.30.00	420 10 420GS
		3506.20.00	350 G350
		3588.30.00	350 10 350GSZ
		4306.30.00	430 10 430WGTZ
		8935.40.00	KZISZ - 5
		4301.20.00	430 MFZ430
		4305.30.00	430 10 430W2GTZ
	4316.30.00	430 10 430WGTZ	
	43460.30.00	430 10 430WGTZ	

Vehicle list





















					
---	---	---	--	---	---

NEOPLAN







N 312 - N 314

N 314, 235kW		4200.90.17	420 10	
		4235.20.00	GF420KR	
		4258.30.00	420GSZ	
		8500.40.00	KZI - 4,5	
		4225.20.00	420	
			GF420KR	
N 314, 206kW		4272.30.00	420 10	
			420WGSZ	
		8500.40.00	KZI - 4,5	
		4244.20.00	420	
			GFX420KR	
		4278.30.00	420 10	
		420W2GSZ		
N 314, 206kW		4200.90.17	420 10	- Engine code: OM422
		4235.20.00	GF420KR	
		4258.30.00	420GSZ	
		8500.40.00	KZI - 4,5	
N 314, 206kW		4225.20.00	420	- Engine code: OM422
			GF420KR	
		42110.20.00	430	- Engine code: OM422
			GMF430	
N 314, 206kW		4250.30.00	420 10	- Engine code: OM422
			420WGSZ	

N 316 - N 318





























N 316		4205.20.00	420	
			G420KR	
		4203.30.00	420 10	
			420GS	
		4301.20.00	430	
			MFZ430	
		4316.30.00	430 10	
			430WGTZ	
		4305.30.00	430 10	
			430W2GTZ	
N 316, 206kW		8935.40.00	KZISZ - 5	
		4306.30.00	430 10	
			430WGTZ	
		4200.90.17	420 10	
		4235.20.00	GF420KR	
		4258.30.00	420GSZ	
		8500.40.00	KZI - 4,5	
		4225.20.00	420	
			GF420KR	
		43460.30.00	430 10	
		430WGTZ		
N 316, 206kW		4200.90.17	420 10	
		4235.20.00	GF420KR	
		4258.30.00	420GSZ	
		8500.40.00	KZI - 4,5	
N 316, 206kW		4225.20.00	420	
			GF420KR	
		4272.30.00	420 10	
			420WGSZ	
N 316, 206kW		8500.40.00	KZI - 4,5	

Vehicle list







					
---	---	---	--	---	---

NEOPLAN

N 316 - N 318















N 316, 235kW			 4200.90.17	420 10	
			 4235.20.00	GF420KR	
			 4258.30.00	420GSZ	
			 8500.40.00	KZI - 4,5	
			 4225.20.00	420	
				GF420KR	
			 4272.30.00	420 10	
				420WGSZ	
			 8500.40.00	KZI - 4,5	
			 4244.20.00	420	
				GFX420KR	
			 4278.30.00	420 10	
	420W2GSZ				
N 316, 280kW N 318, 280kW			 4301.20.00	430	
				MFZ430	
			 4305.20.00	430	
				MFZ430	
			 8935.40.00	KZISZ - 5	
			 4010.10.00	400	- This part number includes one clutch disc
	MFZ2/400X				
			 4021.30.00	400 10	- Loose clutch disc
				400GVZ	
			 4020.30.00	400 10	- Contained in xxxx.10.00
				400GVZ	
N 316 L/U		D 2866 LUH 20	 4301.20.00	430	- GBox: AS-Tronic, ZF
				MFZ430	
			 4305.30.00	430 10	- GBox: AS-Tonicr
	430W2GTZ				
 8919.40.00	KZISZ - 5	- GBox: AS-Tronic - GBox: ZF			
N 318			 4205.20.00	420	
				G420KR	
			 4203.30.00	420 10	
				420GS	
			 4306.30.00	430 10	
				430WGTZ	
			 8935.40.00	KZISZ - 5	
			 4301.20.00	430	
	MFZ430				
			 4305.30.00	430 10	
				430W2GTZ	
			 4316.30.00	430 10	
				430WGTZ	
 43460.30.00	430 10				
	430WGTZ				
N 316, 384kW N 318, 384kW			 4020.30.00	400 10	- Engine code: OM442LA
				400GVZ	
			 4021.30.00	400 10	- Engine code: OM442LA
	400GVZ				
 8935.40.00	KZISZ - 5	- Engine code: OM442LA			

Vehicle list















					
---	---	---	--	---	---

NEOPLAN



N 320 - N 326

N 326, 235kW		4200.90.17	420 10	
		4235.20.00	GF420KR	
		4258.30.00	420GSZ	
		8500.40.00	KZI - 4,5	
		4225.20.00	420	
			GF420KR	
		4272.30.00	420 10	
			420WGSZ	
		8500.40.00	KZI - 4,5	
		4244.20.00	420	
			GFX420KR	
		4278.30.00	420 10	
		420W2GSZ		
N 326, 259kW		4253.20.00	420	
			GFX420KR	
		4257.30.00	420 10	
		420GSZ		
		4250.30.00	420 10	
			420WGSZ	
N 326		4205.20.00	420	
			G420KR	
		4203.30.00	420 10	
			420GS	







N 412 - N 416

N 412		3506.20.00	350	
			G350	
		3588.30.00	350 10	
			350GSZ	
		3120.20.00	310	
			GFX310	
		3124.30.00	310 10	
		310GSBL		
N 413		3506.20.00	350	
			G350	
		3588.30.00	350 10	
			350GSZ	
		4205.20.00	420	
N 414			G420KR	
		4203.30.00	420 10	
			420GS	
		3506.20.00	350	
			G350	
		3588.30.00	350 10	
			350GSZ	
		4205.20.00	420	
N 416			G420KR	
		4203.30.00	420 10	
			420GS	
		4255.30.00	420 10	
		420GS		
		8500.40.00	KZI - 4,5	

N 418 - N 426











N 418 N 426		4205.20.00	420	
			G420KR	
		4203.30.00	420 10	
			420GS	

Vehicle list









					
---	---	---	--	---	---

NEOPLAN

N 516 - N 526















N 516, 280kW			 4301.20.00	430 MFZ430	
			 4305.30.00	430 10 430W2GTZ	
			 8935.40.00	KZISZ - 5	
N 516, 384kW			 4010.10.00	400 MFZ2/400X	- This part number includes one clutch disc
			 4021.30.00	400 10 400GVZ	- Loose clutch disc
			 8935.40.00	KZISZ - 5	
			 4020.30.00	400 10 400GVZ	- Contained in xxxx.10.00
N 516			 4301.20.00	430 MFZ430	
			 4305.30.00	430 10 430W2GTZ	
			 8935.40.00	KZISZ - 5	

N 906 - N 940

N 906 Turbo			 2283.20.00	228 M228KR	- GBox: ZF 4DS18
N 907	01.82 -		 3300.20.00	330 GFM330	
			 3300.30.00	330 10 330GSZ	
			 6901.40.00	KZI - 3	
N 912 N 922 N 940			 3525.20.00	350 GF350KR	
			 3583.30.00	350 10 350GSZ	
			 4225.20.00	420 GF420KR	
			 4235.20.00	420 GF420KR	
			 4258.30.00	420 10 420GSZ	

Skyliner

09.73 -

Skyliner			 4255.30.00	420 10 420GS	
			 4225.20.00	420 GF420KR	
			 4235.20.00	420 GF420KR	
			 4208.30.00	420 10 420GS	
			 4301.20.00	430 MFZ430	- GBox: ZF 8S-180, AS-Tronic
			 4300.30.00	430 10 430GTZ	- GBox: ZF 8S-1800, AS-Tonic
			 8935.40.00	KZISZ - 5	- GBox: ZF 8S-180, AS-Tronic
N 1122/3 L			 4301.20.00	430 MFZ430	- GBox: ZF 8S-1800, 12 AS 2300
			 4300.30.00	430 10 430GTZ	- GBox: ZF 8S-180, 12AS 2300
			 8935.40.00	KZISZ - 5	- GBox: ZF 8S-180, 12AS 2300
N 1122/3 C PB 1	03.06 -	D 2676	 4300.90.105	430 10 MFZ430	- Engine code: D2676 LOH04/27/28, D2676 LOH31/32
			 4386.20.00	430WGTZ	- GBox: AS Tronic
			 4386.30.00	430WGTZ	- Use release fork with rollers
			 8939.40.00	KZISZ - 5	

Vehicle list

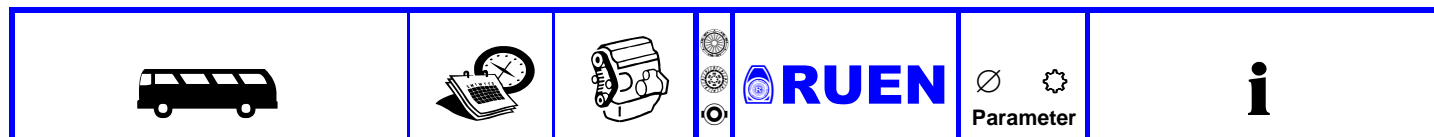

NEOPLAN

Spaceliner 09.79 - 09.92

Spaceliner HC				4301.20.00	430 MFZ430	- Engine code: D 2866 LOH, 301kw, D 2876 LOH, 338kw - GBox: ZF AS-Tronic
				4300.30.00	430 10 430GTZ	- Engine code: D 2866 LOH, 301kw, D 2876 LOH, 338kw - GBox: ZF AS-Tronic
				8935.40.00	KZISZ - 5	- Engine code: D 2866 LOH, 301kw, D 2876 LOH, 338kw - GBox: ZF AS-Tronic

Starliner 09.96 -

N 516 N 516/3	09.96 - 09.02 - 09.02 - 09.96 -	D 2866 LOH 29 D 2876 LOH 01		4301.20.00	430 MFZ430	- GBox: ZF 8S- 180 - GBox: ZF 12 AS 2300
				4300.30.00	430 10 430GTZ	
				8935.40.00	KZISZ - 5	
N 5218 SHD, 353kW N 5218 SHD, 390kW	05.05 - 05.05 -	D 2876 LOH 20 D 2876 LOH 21		4300.90.12	430 10 MFZ430	- GBox: AS- Tronic
				4339.20.00	430WGTZ	
				4386.30.00	KZISZ - 5	
				8919.40.00		
				4300.90.77	430 10 MFZ430	- GBox: AS-Tronic
				4339.20.00	430WGTZ	
				4386.30.00	KZISZ - 5	
				8939.40.00		
Starliner L P12 00 N 5217 SHD P11 00	02.04 - 02.05 -			4300.90.105	430 10 MFZ430	- Engine code: D2876LOH - GBox: AS-Tronic - Use release fork with rollers
				4386.20.00	430WGTZ	
				4386.30.00	KZISZ - 5	
				8939.40.00		
				4319.20.00	430 MFZ430	- Engine code: D2066 LOH07/08/10, D2066 LOH28/32, - Engine code: D2066 LUH09/24/34/53, D2676 LOH10/26/30 - GBox: AS-Tronic
				4346.30.00	430 10 430WGTZ	- Engine code: D2066 LOH07/08/10, D2066 LOH28/32 - Engine code: D2066 LUH09/24/34/53, D2676 LOH10/26/30 - GBox: AS-Tronic
				8919.40.00	KZISZ - 5	- Engine code: D2066 LOH07/08/10, D2066 LOH28/32 - Engine code: D2066 LUH09/24/34/53, D2676 LOH10/26/30 - GBox: AS-Tronic - Use release fork with cam

Vehicle list

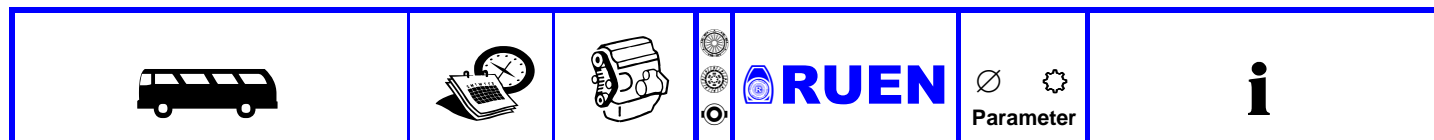

NEOPLAN

Starliner 09.96 -

N 2216 SHD, 228kW N 2216 SHD, 265kW N 2216 SHD, 301kW N 2216 SHD, 6x2 N 2216 SHD, 4x2	01.02 -	D 2866 LOH 27	4300.90.56	430 10	- Engine code: D2066 LUH09/24/34/53, D2066 LOH07/08/10	
	01.02 -	D 2866 LOH 28	4319.20.00	MFZ430	- Engine code: D2066 LOH28/32, D2676 LOH10/26/30	
	01.02 -	D 2866 LOH 29	4346.30.00	430WGTZ	- GBox: AS-Tronic	
	01.02 -	D 2876 LOH 01	8939.40.00	KZISZ - 5	- Use release fork with rollers	
				4301.20.00	430 MFZ430	- Engine code: D2066 LOH07/08/10, D2066 LOH28/32
				8944.40.00	KZIZ-5	- Engine code: D2066 LUH09/24/34/53, D2066 LOH07/08/10
			8919.40.00	KZISZ - 5	- Engine code: D2066 LOH28/32, D2676 LOH10/26/30	
			4300.90.184	430 10	- Engine code: D2066 LUH09/24/34/53, D2066 LOH07/08/10	
			43100.20.00	MFZ430E	- Engine code: D2676 LOH10/26/30	
			43461.30.00	430WGTZ	- GBox: AS-Tronic	
			8916.40.00	KZIZ - 5	- GBox: ZF 6/8 S	
			43460.30.00	430 10 430WGTZ	- Only install together	
					- Engine code: D2866 LOH/LUH	
					- GBox: AS-Tronic	

Tourliner 09.02 -

N 2216 SHD, 301kW N 2216 SHD, 338kW N 2216 SHDL, 301kW N 2216 SHDL, 338kW	01.03 -	D 2866 LOH 34	4301.20.00	430	- GBox: ZF 8S-180	
	01.03 -	D 2876 LOH 03	4306.30.00	MFZ430	- GBox: ZF 8S-180	
	01.03 -		4306.30.00	430 10 430WGTZ	- GBox: ZF 8S-180	
	01.03 -		8916.40.00	KZIZ - 5	- GBox: ZF 8S-180	
				4300.90.12	430 10	- GBox: AS-Tronic
				4339.20.00	MFZ430	
				4386.30.00	430WGTZ	
			8919.40.00	KZISZ - 5		
			4300.90.77	430 10	- GBox: AS Tronic	
			4339.20.00	MFZ430		
			4386.30.00	430WGTZ		
			8939.40.00	KZISZ - 5		
			4300.90.184	430 10	- Engine code: D2866 LOH29/33/34	
			43100.20.00	MFZ430E	- GBox: ZF 6/8 S	
			43461.30.00	430WGTZ	- Only install together	
			8916.40.00	KZIZ - 5		
			43460.30.00	430 10 430WGTZ		

Vehicle list

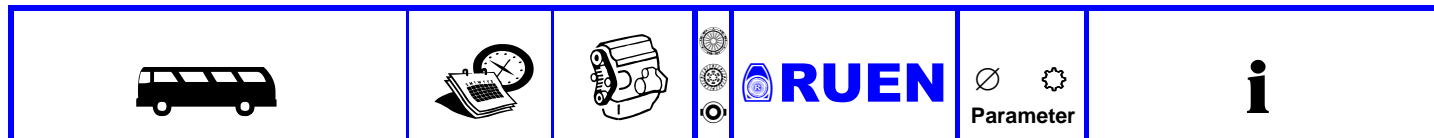

NEOPLAN







Tourliner 09.02 -

N 2216/3SHD Tourliner C P20 00	09.05 -		4300.90.56 4319.20.00 4346.30.00 8939.40.00	430 10 MFZ430 430WGTZ KZISZ - 5	- Engine code: D2066 LUH09/24/34/53, D2066 LOH 07/08/10 - Engine code: D2066 LOH 28/32, D2676 LOH 10/26/30 - GBox: AS Tronic - Use release fork with rollers
			8919.40.00	KZISZ - 5	- Engine code: D2066 LUH09/24/34/53, D2066 LOH 07/08/10 - Engine code: D2066 LOH 28/32, D2676 LOH 10/26/30 - GBox: AS Tronic - Use release fork with cam
			4301.20.00	430 MFZ430	- Engine code: D2066 LOH 07/08/10, D2066 LOH 28/32 - Engine code: D2676 LOH 10/26/30 - GBox: GO 210-6
			8944.40.00	KZIZ-5	- Engine code: D2066 LOH 07/08/10, D2066 LOH 28/32, - Engine code: D2676 LOH 10/26/30 - GBox: GO 210-6
			4300.90.182 43100.20.00 43134.30.00 8916.40.00	430 10 MFZ430E 430WGTZ KZIZ - 5	- Engine code: D2066 LUH09/24/34, D2066 LOH07/08/10/28 - Engine code: D2676 LOH10 - GBox: ZF 6 S - Only install together
N 2216 SHD, 294kW N 2216 SHD, 324kW N 2216 SHDL, 324kW	06.06 - 06.06 - 06.06 -	D 2066 LOH 03 D 2066 LOH 04	8919.40.00	KZISZ - 5	- Engine code: D2866 LOH/LUH - GBox: AS-Tronic - Use release fork with cam
			4386.30.00	430 10 430WGTZ	- Engine code: D2876 LOH - GBox: AS-Tronic
			4300.90.56 4319.20.00 4346.30.00 8939.40.00	430 10 MFZ430 430WGTZ KZISZ - 5	- Engine code: D2066 LUH09/24/34/53, D2066 LOH07/08/10 - Engine code: D2066 LOH28/32, D2676 LOH10/26/30 - GBox: AS-Tronic - Use release fork with rollers
			4300.90.184 43100.20.00 43461.30.00 8916.40.00	430 10 MFZ430E 430WGTZ KZIZ - 5	- Engine code: D2866 LOH29/33/34 - GBox: ZF 6/8 S - Only install together
			43460.30.00	430 10 430WGTZ	

Trendliner 09.04 -

N 3516 Ü, 228kW N 3516/3 ÜL	09.04 - 09.04 -		4319.20.00	430 MFZ430	- GBox: AS-Tronic
			4306.30.00	430 10 430WGTZ	- GBox: AS Tronic
			8919.40.00	KZISZ - 5	- GBox: AS Tronic
			4300.90.182 43100.20.00 43134.30.00 8916.40.00	430 10 MFZ430E 430WGTZ KZIZ - 5	- Engine code: D2066 LUH09/24/34, D2066 LOH07/08/10/28 - Engine code: D2676 LOH - GBox: ZF 6S - Only install together
			4300.90.183 43100.20.00 43461.30.00 8916.40.00	430 10 MFZ430E 430WGTZ KZIZ - 5	- Engine code: D2866 LUH 28 228KW, D2066 LOH07/22/27 - Engine code: D2066 LOH32/47 - GBox: ZF 6S - Only install together
			4300.90.184 43100.20.00 43461.30.00 8916.40.00	430 10 MFZ430E 430WGTZ KZIZ - 5	- Engine code: D2866 LUH29/37/265KW, D2866 LUH29/37/301KW - Engine code: D2066 LUH08/23/28, D2066 LUH33/48, D2066 LUH/33/48 - Engine code: D2066 LOH06/27 - GBox: ZF 6S - Only install together
			43460.30.00	430 10 430WGTZ	



























Vehicle list

					
---	---	---	--	---	---

NEOPLAN



Trendliner

09.04 -

13 M P25 00 N 3516 Ü, 265kW N 3516 Ü, 301kW	09.04 - 09.04 -	D 2866 LUH 29	 4300.90.56	430 10	- Engine code: D2066 LUH09/24/34/53, D2066 LOH07/08/10 - Engine code: D2066 LOH28/32 - GBox: AS-Tronic - Use release fork with rollers	
			 4319.20.00	MFZ430		
			 4346.30.00	430WGTZ		
			 8939.40.00	KZISZ - 5		
			 8919.40.00	KZISZ - 5		- Engine code: D2066 LUH09/24/34/53, D2066 LOH07/08/10 - Engine code: D2066 LUH09/24/34/53, D2066 LOH07/08/10 - GBox: AS-Tronic - Use release fork with cam
			 4300.90.180 	430 10		- Engine code: D2866 LUH29/37/265KW, D2866 LUH29/301KW - GBox: GO210-6 - Only install together
			 43100.20.00	MFZ430E		
			 4346.30.00	430WGTZ		
 8939.40.00	KZISZ - 5					
 4300.90.182 	430 10	- Engine code: D2066 LUH09/24/34, D2066 LOH07/08/10/28 - Engine code: D2676 LOH - GBox: ZF 6S - Only install together				
 43100.20.00	MFZ430E					
 43134.30.00	430WGTZ					
 8916.40.00	KZIZ - 5					
 4300.90.183 	430 10	- Engine code: D2866 LUH 28 228KW, D2066 LOH07/22/27 - Engine code: D2066 LOH32/47 - GBox: ZF 6S - Only install together				
 43100.20.00	MFZ430E					
 43461.30.00	430WGTZ					
 8916.40.00	KZIZ - 5					
 4300.90.184 	430 10	- Engine code: D2866 LUH29/37/265KW, D2866 LUH29/37/301KW - Engine code: D2066 LUH08/23/28, D2066 LUH33/48, D2066 LUH/33/48 - Engine code: D2066 LOH06/27 - GBox: ZF 6S - Only install together				
 43100.20.00	MFZ430E					
 43461.30.00	430WGTZ					
 8916.40.00	KZIZ - 5					
 43460.30.00	430 10 430WGTZ					



ÖSTERREICHISCHE AUTOMOBILFABRIK (ÖAF)

Omnibus





Omnibus GSR + GSL	 4235.20.00	420 GF420KR	
	 4225.20.00	420 GF420KR	
	 4283.30.00	420 10 420WGSZ	

OTOKAR (TÜRKİYE)







MGR 912/4

MAGIRUS 912/4	 2518.20.00	250 G250	
	 2518.30.00	250 10 250GSZ	

SULTAN



OTOKAR SULTAN Maxi	 3574.20.00	350 14" MF 350	
	 3598.30.00	350 10 350WGTZ	
OTOKAR SULTAN 115-125-145(25kisi)	 3174.20.00	310 MF310	
	 3133.30.00	310 10 310GSBL	

Vehicle list

					
---	---	---	--	---	---





OTOYOL (TÜRKİYE)

EUROBUS E25.12/E25.14/E29/14

EUROBUS E25.12/E25.14/E29/14 IVECO Eurocargo Midibus				3188.20.00	310 MFZ 310	
				3133.30.00	310 10 310GSBL	

PEUGEOT

J5 Bus (280P) 09.81 - 09.90









2.0, 55kW 2.0, 58kW	09.81 - 09.90 01.83 - 09.90	170 (XN1T) 170B (XN1T)		2150.90.18	215 21	- To model year: ->07.1989	
					2185.20.00		CP215
					2178.30.00		215CE
					3211.40.00		KZIS - 0

J5 Bus (290P) 09.90 - 03.94

















1.9 D	10.90 -	D9B (XUD9A)		2150.90.16	215 21	
					2185.20.00	CP215

RENAULT









MASTER I Bus (T__) 08.80 - 07.98

28-35 2.0	10.86 - 07.98	J5R 718		2150.90.07	215 21	- To model year: ->02.1989	
					2185.20.00		CP215
					2178.30.00		215CE
28-35 2.4 D	08.80 - 08.89	8140.61.2300 S8U 731		2150.90.07	215 21		
					2185.20.00		CP215
					2178.30.00		215CE
					3233.40.00		KZAS - 0B
				2185.20.00	215	- To model year: ->12.1982	
				3233.40.00	KZAS - 0B	- To model year: ->12.1982	







TRAFIC Bus (T5, T6, T7) 03.80 - 04.89

1.6 1.6, 4x4	01.84 - 06.86 03.80 - 08.86	841 705 A1M 707 A1M 708		2000.90.36	200 21		
					2042.20.00		CP20
					2045.30.00		200D
				3216.40.00	KZAS - 0		
1.7	06.86 - 04.89	F1N 724		2000.90.19	200 26		
					2023.20.00		DB200
					2034.30.00		200CE
					3224.40.00		KZAS - 00
2.0 2.0, 4x4	06.89 - 04.89 06.86 - 04.89	J5R 716 J5R 722 J5R 726		2150.90.42	215 21		
					2185.20.00		CP215
					2178.30.00		215CE
					3216.40.00		KZAS - 0
2.1 D	03.80 - 04.89	852 750		2000.90.40	200 21		
					2042.20.00		CP20
					2080.30.00		200VTB
					3216.40.00		KZAS - 0

TRAFIC Bus (TXW) 03.89 - 03.01

1.7	08.92 - 08.94	F1N 724		2000.90.19	200 26		
					2023.20.00		DB200
					2034.30.00		200CE
				3224.40.00	KZAS - 00		
2.0 2.2, 70kW	05.89 - 08.90 05.89 - 06.94	J5R 726 J7T 780		2150.90.42	215 21		
					2185.20.00		CP215
					2178.30.00		215CE
					3216.40.00		KZAS - 0

















Vehicle list

					
---	---	---	--	---	---

RENAULT





TRAFIC Bus (TXW)

03.89 - 03.01







2.2, 74kW	06.94 - 10.97	J7T 600		2000.90.40	200 21	
				2042.20.00	CP20	
				2080.30.00	200VTB	
				3216.40.00	KZAS - 0	
				2150.90.42	215 21	
				2185.20.00	CP215	
				2178.30.00	215CE	
				3216.40.00	KZAS - 0	
2.1 D, 43kW 2.1 D, 47kW	05.89 - 06.94	852 720		2000.90.40	200 21	
	06.94 - 10.97	852 750		2042.20.00	CP20	
		J8S 620		2080.30.00	200VTB	
		J8S 758		3216.40.00	KZAS - 0	
2.5 D	05.89 - 03.01	8140.67.2500		2000.90.40	200 21	- From model year: 10.1994->
		8140.67.2550		2042.20.00	CP20	
		8140.67.2580		2080.30.00	200VTB	
		S8U 750		3216.40.00	KZAS - 0	
		S8U 752				
S8U 758						

RENAULT TRUCKS

series PR







10 S (6G.)	12.78 -			3866.20.00	380 GM380K	- GBox: BDSL
12 S (6G.) 14 S	02.78 - 01.76 -			3866.20.00	380 GM380K	- GBox: BDSL
14				3866.20.00	380 GM380K	- GBox: BDSL
8	01.86 -			3574.20.00	350 14" MF 350	

series S







45				3562.20.00	350 GMF350	- From chassis no.: 365->
				3570.30.00	350 10 350Z	- From chassis no.: 365->
53				3562.20.00	350 GMF350	- From chassis no.: 1512->
				3570.30.00	350 10 350Z	- From chassis no.: 1512->
105	10.92 -			3562.20.00	350 GMF350	- GBox: RVI332
				3570.30.00	350 10 350Z	- GBox: RVI332
90 SB 2 LE SB 2 MBD	05.83 - 10.70 - 12.79 - 12.79			2525.20.00	250 MF250	- Engine code: 720 - GBox: ZFS5-24, 321 - GBox: 321

ARES

- 03.99

Ares				4311.20.00	430 MFZ430	- GBox: B8 TBV - GBox: ZF 6S-85, ZF 8S-180
				4311.30.00	430 20 430W2GTZ	- GBox: B8 TBV - GBox: ZF 6S-85, ZF 8S-180
				8937.40.00	KZISZ-5	- GBox: B8 TBV - GBox: ZF 6S-85, ZF 8S-180
				4305.30.00	430 10 430W2GTZ	- GBox: ZF 8S-180 - To model year: ->10.2001
				4312.30.00	430 10 430W2GTZ	- GBox: ZF 6S-85
				8935.40.00	KZISZ - 5	- GBox: ZF 6S-1600



Vehicle list

					
---	---	---	--	---	---







RENAULT TRUCKS

AXER

- 03.99

C956			 4007.30.00	400 10 400WGTZ	
			 8935.40.00	KZISZ - 5	



















E 7

E 7 L, M, N			 3835.20.00	380 GF380	- Engine code: MAN2156
			 3866.20.00	380 GM380K	- Engine code: MAN2356
E 7 C	01.75 -		 3500.90.42	350 10 14" MF 350	- Engine code: 798
			 3574.20.00	350GSZ	- GBox: ZFS5-35
			 3587.30.00	KZIS-3	
			 8525.40.00		







E 53

Serie E 53	06.71 - 12.79		 3866.20.00	380 GM380K	
------------	---------------	--	---	----------------------	--







































FR 1

FR 1	04.90 -		 4300.90.75 ⊕	430 10 MFZ430	- From model year: 10.1992->
			 4335.60.00	430GTZ	- GBox: ZF 8S-180
			 4327.30.00		
			 4300.90.47 ⊕	430 10 MFZ430	- From model year: 10.1992->
			 4335.60.00	430W2GTZ	- GBox: ZF S6-90, S6-85
			 4312.30.00		
			 4300.90.48 ⊕	430 20 MFZ430	- From model year: 10.1992->
			 4335.60.00	430W2GTZ	- GBox: B8L
			 4311.30.00		
FR 1 E-T-GT	11.92 -		 4300.90.47 ⊕	430 10 MFZ430	- GBox: ZF S6-90, ZF S6-85
			 4335.60.00	430W2GTZ	
			 4312.30.00		
			 4300.90.75 ⊕	430 10 MFZ430	- GBox: ZF S8-180
			 4335.60.00	430GTZ	
			 4327.30.00		
			 4300.90.48 ⊕	430 20 MFZ430	- GBox: B9/B8L
			 4335.60.00	430W2GTZ	
			 4311.30.00		

Vehicle list

					
---	---	---	--	---	---

RENAULT TRUCKS

ILIADÉ - 03.99					
iliade	10.96 -		 4300.90.48 ⊕  4335.60.00  4311.30.00	430 20 MFZ430 430W2GTZ	- To model year: ->05.1997 - GBox: B8 170r1 TBV
			 4300.90.61 ⊕  4311.20.00  4311.30.00  8937.40.00	430 20 MFZ430 430W2GTZ KZISZ-5	- From model year: 06.1997-> - GBox: B9, B8 1700RS TBV
			 4300.90.47 ⊕  4335.60.00  4312.30.00	430 10 MFZ430 430W2GTZ	- To model year: ->08.1997 - GBox: ZF S6-85
			 4300.90.60  4311.20.00  4312.30.00  8937.40.00	430 10 MFZ430 430W2GTZ KZISZ-5	- From model year: 09.1997-> - GBox: ZF 6S-85
			 4336.60.00 ⊕	430 MFZ430	- To model year: ->10.1997 - GBox: ZF S8-180
			 4305.30.00	430 10 430W2GTZ	- To model year: ->10.1997 - GBox: ZF S8-180
			 8936.40.00	KZISZ - 5	- To model year: ->10.1997 - GBox: ZF S8-180
			 4300.90.54  4311.20.00  4346.30.00  8937.40.00	430 10 MFZ430 430WGTZ KZISZ-5	- From model year: 10.1997-> - GBox: ZF S8-180
			 4311.20.00	430 MFZ430	- GBox: ZF 6S-1600
			 8937.40.00	KZISZ-5	- GBox: ZF 6S-1600
KAROSA - 03.99					
MIHR 062045			 4335.60.00 ⊕	430 MFZ430	
			 4312.30.00	430 10 430W2GTZ	
			 8936.40.00	KZISZ - 5	
OBRADORE - 03.99					
Obradore	10.96 -		 4300.90.61 ⊕  4311.20.00  4311.30.00  8937.40.00	430 20 MFZ430 430W2GTZ KZISZ-5	- GBox: B9/B8L
			 4311.20.00	430 MFZ430	- GBox: ZF S8-180
			 4327.30.00	430 10 430GTZ	- GBox: ZF S8-180
			 8937.40.00	KZISZ-5	- GBox: ZF S8-180
RÉCREO - 03.99					
C935	10.96 -		 4300.90.47 ⊕  4335.60.00  4312.30.00	430 10 MFZ430 430W2GTZ	- Engine code: MIHR062045A/41 - GBox: 5P 115
C955			 4007.30.00	400 10 400WGTZ	
			 8935.40.00	KZISZ - 5	
TRACER - 03.99					
332			 8936.40.00	KZISZ - 5	- To model year: ->12.1992 - GBox: G406



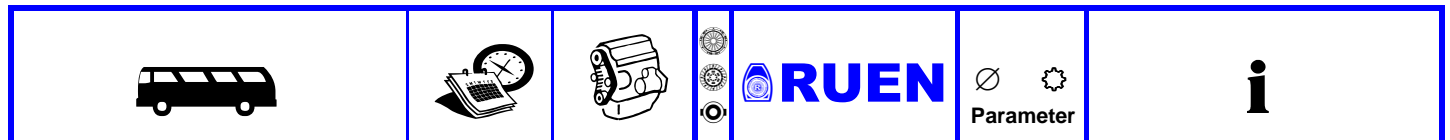



Vehicle list

















































SCANIA

Bus					
BR 116			4200.90.84 4263.20.00 4261.30.00	420 22 GMF420K 420GSZ	- GBox: G764, G774
			4263.20.00	420 GMF420K	- GBox: G764, G774
			4235.30.00	420 10 420/210GS	- GBox: G764
B 116			4263.20.00	420 GMF420K	
			4235.30.00	420 10 420/210GS	
BR 85 BR 86			4261.20.00	420 GMF420K	
			4208.30.00	420 10 420GS	
BR 140 BR 145			4201.20.00	420 G420KR	
			4208.30.00	420 10 420GS	
CR 85			4261.20.00	420 GMF420K	
			4208.30.00	420 10 420GS	
K 82			4263.20.00	420 GMF420K	
			4235.30.00	420 10 420/210GS	
K94 / L94 / N94 / 114 / 124	01.95 -		4300.90.11 4331.60.00 4333.30.00	430 24 MFZ430 430WGTZ	
			4313.20.00	430 MFZ430	- Contained in xxxx.60.00
			8923.40.00	KZIZ - 5	
			4333.30.00	430 24 430WGTZ	
			4300.90.09 4328.20.00 4333.30.00 8631.47.00	430 24 MFZ430 430WGTZ HHISZ-4	
			4328.20.00	430 MFZ430	
			4300.90.51 4313.20.00 4333.30.00 8934.40.00	430 24 MFZ430 430WGTZ KZISZ - 5	
			4313.26.00	430 MFZ430	

Vehicle list

					
---	---	---	--	---	---

SCANIA

Bus					
K 112			 4200.90.77	420 10	
			 4256.20.00	GMF420K	
			 4244.30.00	420/210GSZ	
			 8505.40.00	KZI - 4,5	
			 4256.20.00	420	
				GMF420K	
			 4248.20.00	420	
				GFX420KR	
			 4255.30.00	420 10	
				420GS	
	 8514.40.00	KZI - 4,5			
	 4261.20.00	420			
		GMF420K			
	 4261.30.00	420 22			
		420GSZ			
	 4200.90.84 	420 22			
	 4263.20.00	GMF420K			
	 4261.30.00	420GSZ			
	 4263.20.00	420			
		GMF420K			
	 4235.30.00	420 10			
		420/210GS			
3 - series bus 01.89 - 12.97					
L 113 CLB	01.90 - 12.96	DS 11.34 DSC 11.08	 4000.90.61 	400 22	
			 4060.60.00	MFZ400X	
			 4052.30.00	400GVZ	
			 4000.90.60 	400 24	
			 4060.60.00	MFZ400X	
			 4051.30.00	400WGVZ	
			 4200.90.84 	420 22	
	 4263.20.00	GMF420K			
	 4261.30.00	420GSZ			
	 42106.30.00	420 24			
		420WGTZ			
	 4333.30.00	430 24			
		430WGTZ			
	 4313.20.00	430			
		MFZ430			
K 93 CL K 113 K 113 CLB L 113 CLB	01.91 - 12.96 11.90 - 07.90 - 12.96 01.91 - 12.97 11.93 - 12.96	DS 11.34 DS 11.73 DSC 11.08 DSC 11.22 DSC 11.24 DSC 11.81 DSC 9.08	 4000.90.61 	400 22	
			 4060.60.00	MFZ400X	
			 4052.30.00	400GVZ	
			 4000.90.60 	400 24	
			 4060.60.00	MFZ400X	
			 4051.30.00	400WGVZ	
			 4200.90.84 	420 22	
				 4263.20.00	GMF420K
	 4261.30.00	420GSZ			
	 42106.30.00	420 24			
		420WGTZ			
	 4333.30.00	430 24			
		430WGTZ			
	 4313.20.00	430			
		MFZ430			



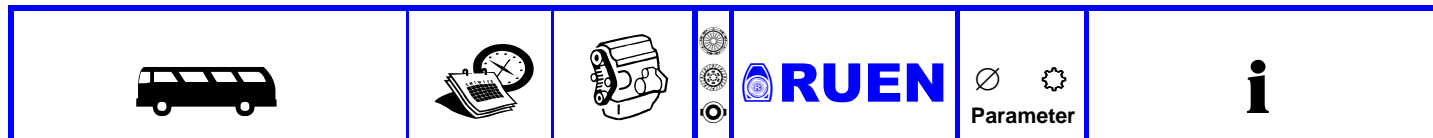



Vehicle list



SETRA

Series 300		09.91 - 02.02					
S315GT, S315GT-HD, S315HD, S315HDH 315.031, 317.011, 317.010, 345.000, 315.032	09.91 - 02.02	OM 446.930 OM 446.931		4307.20.00	430 MFZ430		
				4306.30.00	430 10 430WGTZ		
S317GT-HD, S317HD, S317HDH, S319GT-HD 345.010	09.91 - 02.02	OM 442.980		3822.20.00	380 GF380KR		
				3822.30.00	380 10 380GSZ		
				8502.40.00	KZI - 4		
S313UL, S315H, S315UL, S315NF	09.91 - 02.02			4300.90.180 ■	430 10 MFZ430E	- Engine code: OM 457HLA - Equipment Var: S 315 H - GBox: GO 190 - Only install together	
				43100.20.00	430WGTZ		
				4346.30.00	430WGTZ		
				8939.40.00	KZISZ - 5		
Series 400		06.01 -					
ComfortClass S 416 GT-HD, ComfortClass S 417 GT-HD 632.134, 632.133, 310kW	10.03 -	OM 457.944 OM 457.953 OM 457.961		4304.20.00	430 MFZ430		
				4312.30.00	430 10 430W2GTZ		
				8928.40.00	KZIZ - 5	- For: OE Nr. 002 250 08 15	
				8905.40.00	KZIZ - 5	- For: OE Nr.001 250 98 15	
ComfortClass S 415 GT 632.121, 185kW ComfortClass S 415 GT 632.121, 300kW ComfortClass S 415 GT, GT-HD 632.121, 632.131, 260kW ComfortClass S 415 GT, GT-HD 632.121, 632.131, 300kW ComfortClass S 415 GT, S 416 GT632.121, 632.125 TopClass S 431 DT 410.001	10.03 -	OM 457.941 OM 457.944		4307.20.00	430 MFZ430		
	10.03 -	OM 457.952 OM 457.953		43461.30.00	430 10 430WGTZ		
	10.03 -	OM 457.961		8944.40.00	KZIZ-5		
	10.03 -	OM 457.965 OM 542.948		4300.90.180 ■	430 10 MFZ430E	- Only install together	
	10.03 -	OM 542.966		43100.20.00 4346.30.00 8939.40.00	430WGTZ KZISZ - 5		
ComfortClass S 416 GT-HD, ComfortClass S 417 GT-HD 632.134, 632.133, 260kW S 415 HDH 629.623 S 416 HDH 629.625 S 417 HDH 629.627	10.03 -	OM 457 LA OM 457.944		4348.30.00	430 10 430WGTZ	- Engine code: OM457 - GBox: Powershift	
	01.07 -	OM 457.953 OM 457.961		8944.40.00	KZIZ-5	- Engine code: OM457 - GBox: Powershift	
	01.07 -			4307.20.00	430 MFZ430	- Engine code: OM5*2 - GBox: Powershift	
	01.07 -			43461.30.00	430 10 430WGTZ	- Engine code: OM5*2 - GBox: Powershift	
					4300.90.180 ■	430 10 MFZ430E	- Only install together
					43100.20.00 4346.30.00 8939.40.00	430WGTZ KZISZ - 5	
TopClass S 415 HD 629.411, 629.612, 310kW TopClass S 415 HD 629.411, 629.612, 370kW TopClass S 415 HDH 629.623, 629.421, 260kW TopClass S 415 HDH 629.623, 629.421, 310kW TopClass S 415 HDH 629.623, 629.421, 335kW TopClass S 415 HDH 629.623, 629.421, 370kW	10.01 -	OM 457.944 OM 457.953		8919.40.00	KZISZ - 5	- Engine code: OM457.944 - GBox: AS Tronic - Use release fork with cam	
	10.01 -	OM 457.961		8939.40.00	KZISZ - 5	- Engine code: OM457.944 - GBox: AS Tronic - Use release fork with rollers	
	10.01 -	OM 542.948 OM 542.966		4300.90.180 ■	430 10 MFZ430E	- Engine code: OM457.944 - GBox: GO 210 - Only install together	
	10.01 -			43100.20.00 4346.30.00 8939.40.00	430WGTZ KZISZ - 5		
	10.01 -			8944.40.00	KZIZ-5		
	10.02 -	OM 542.948		4300.90.180 ■	430 10 MFZ430E	- Engine code: OM 502 - Only install together	
			43100.20.00 4346.30.00 8939.40.00	430WGTZ KZISZ - 5			































Vehicle list

					
---	---	---	--	---	---

SETRA





Series 400

06.01 -



TopClass S 411 HD 629.610, 629.410, 260kW	10.01 -	OM 457.944		4300.90.180 	430 10	- Only install together
TopClass S 411 HD 629.610, 629.410, 300kW	10.01 -	OM 457.953		 43100.20.00	MFZ430E	
TopClass S 415 HD 629.411, 629.612, 260kW	10.01 -	OM 457.961		 4346.30.00	430WGTZ	
TopClass S 416 HDH, TopClass S 417 HDH 629.422, 629.425, 629.625	10.01 -	OM 541.950		 8939.40.00	KZISZ - 5	
MultiClass S 412 UL 633.100		OM 542.948				
MultiClass S 415 UL 633.101		OM 542.966		4300.90.180 	430 10	- GBox: G0/190/210
MultiClass S 417 UL 633.103				 43100.20.00	MFZ430E	- Only install together
MultiClass S 419 UL 633.104				 4346.30.00	430WGTZ	
				 8939.40.00	KZISZ - 5	
ComfortClass S 416 GT-HD 632.134, 320kW	10.03 -	OM 457.961		4307.20.00	430	
ComfortClass S 416 GT-HD 632.134, 350kW	10.03 -			43461.30.00	430 10	
ComfortClass S 416 GT-HD 632.134, 370kW	10.03 -			8944.40.00	430WGTZ	
ComfortClass S 416 GT-HD 632.134, 335kW	10.03 -			4307.20.00	430	
				43461.30.00	430 10	
				8944.40.00	430WGTZ	
				4300.90.405	430 10	
				 4301.20.00	MFZ430	
				 4348.30.00	430WGTZ	
				 8944.40.00	KZISZ-5	

SETRA (TÜRKİYE)



S 210 - 213 - 215 - 216

SETRA				4235.20.00	420	
				4250.30.00	420 10	
					GF420KR	
					420WGSZ	
SETRA				4235.20.00	420	
				4282.30.00	420 10	
					GF420KR	
					420WGVZ	

S 309 - 315



SETRA				4304.20.00	430	
				4316.30.00	430 10	
					MFZ430	
					430WGTZ	

S 317 - 319







SETRA				4301.20.00	430	
				4305.30.00	430 10	
					MFZ430	
					430W2GTZ	

TAM

































Bus

75 A5,6				2802.20.00	280	
				2803.30.00	280 6	
					G280	
				6606.40.00	280BHZ	
					KFL - 555	







Vehicle list

					
---	---	---	--	---	---

TAM









Bus					
120 B3			 4305.20.00	430 MFZ430	
			 4305.30.00	430 10 430W2GTZ	
			 8916.40.00	KZIZ - 5	
125 A 11T,P 3000 A 3000 3500 AS 3500,D125			 3505.20.00	350 G350KR	
			 3588.30.00	350 10 350GSZ	
			 6907.40.00	KZI - 3	
190 107M 190 A11 190 A110 190 A94, 102, 131	- 04.90		 3810.20.00	380 G380KR	
	- 04.90		 3857.30.00	380 10 380W2GSZ	
	05.90 - - 04.90		 8500.40.00	KZI - 4,5	
260			 4200.90.17	420 10 GF420KR	
			 4235.20.00	420GSZ	
			 4258.30.00	KZI - 4,5	
260 A113 260 A116 260 A117 260 A119 260 A120 260 A180			 4224.20.00	420 GF420KR	
			 4201.20.00	420 G420KR	
			 4250.30.00	420 10 420WGSZ	
321 A119			 8500.40.00	KZI - 4,5	
			 4244.20.00	420 GFX420KR	- GBox: ZF
			 4250.30.00	420 10 420WGSZ	- GBox: ZF
3500 AS 3500 D150			 8511.40.00	KZI - 4,5	- GBox: ZF
			 3588.30.00	350 10 350GSZ	
			 3951.20.00	395 MF395	
TVM Marbus B3 090 TH TVM Marbus B3 090 TL TVM Marbus B3 090 TLL			 3951.30.00	395 10 395WGTZ	
			 3951.20.00	395 MF395	
TVM Marbus B4 080 TS			 3951.30.00	395 10 395WGTZ	
			 2821.20.00	280 MF280K	
80 A50 2.6, A60 3.2, Minibus			 2821.30.00	280 10 280GTZ	
			 6606.40.00	KFL - 555	
			 3503.20.00	350 G350KR	
170 A11, T, P, M			 3503.30.00	350 10 350GSZ	
			 8401.40.00	KZI - 4,5	
			 3103.20.00	310 GF310KR	
111 A70, 130 A85S			 3102.30.00	310 10 310GSZ	
			 6907.40.00	KZI - 3	

Vehicle list

					
---	---	---	--	---	---



TAM

Bus

150 A11, T, P, M		3802.20.00	380 G380KR	
		3802.30.00	380 10 380GSZ	
		6907.40.00	KZI - 3	
B3 075T, CS, 122 A7 OT		3164.20.00	310 MF310	
		3140.30.00	310 10 310W2GSZ	
		6907.40.00	KZI - 3	
331 A119		4253.20.00	420 GFX420KR	
		4250.30.00	420 10 420WGSZ	



TEMSA

SAFARI





Safari 13		4303.20.00	430 MFZ430	- GBox: ZF 8S-180
		4306.30.00	430 10 430WGTZ	- GBox: ZF 8S-180
		8935.40.00	KZISZ - 5	- GBox: ZF 8S-180

TEMSA (TÜRKİYE)

POWERBUS - OPAL



POWERBUS		3608.20.00	362 MF362	
		3607.30.00	362 10 362WGTZ	

DIAMOND - SAFARI

DIAMOND		4301.20.00	430 MFZ430	
		4306.30.00	430 10 430WGTZ	
		8916.40.00	KZIZ - 5	
DIAMOND Yeni Dizayn		8916.40.00	KZIZ - 5	





TEZELLER-TÜRKAR (TÜRKİYE)

TEZELLER-TÜRKAR







TEZELLER-TÜRKAR		3574.20.00	350 14" MF 350	
		3598.30.00	350 10 350WGTZ	

VAN HOOL



































A 120

A 120		4205.20.00	420 G420KR	
		4208.30.00	420 10 420GS	
		4222.20.00	420 GF420KR	
		4297.30.00	420 10 420GSZ	
		8514.40.00	KZI - 4,5	







Vehicle list

					
---	---	---	--	---	---

















VAN HOOL





8..					
812				4235.20.00	420 GF420KR
813					
814				4258.30.00	420 10 420GSZ
815 A					
815 C				8514.40.00	KZI - 4,5
815 TL					
815, A, 191kW				4208.30.00	420 10 420GS
815 C					
815, A, 257kW				4268.30.00	420 10 420GSZ
TD 824					
				8514.40.00	KZI - 4,5
815				4244.20.00	420 GFX420KR
				4257.30.00	420 10 420GSZ
				8505.40.00	KZI - 4,5
				4245.20.00	420 GFX420KR
				4275.30.00	420 10 420W2GSZ
				4235.20.00	420 GF420KR
				4258.30.00	420 10 420GSZ
				8514.40.00	KZI - 4,5
				4256.20.00	420 GMF420K
				4200.90.22	420 10
				4248.20.00	GFX420KR
				4244.30.00	420/210GSZ
				8514.40.00	KZI - 4,5
815 GT				4244.20.00	420 GFX420KR
				4257.20.00	420 GMF420K
				8505.40.00	KZI - 4,5
815 TLC				4256.20.00	420 GMF420K
				4314.30.00	430 10 430WGTZ
					- Engine code: MAN D 2866 LUH08 - Transmission type: ZF6S-85
816 (Altano Royal)				4245.20.00	420 GFX420KR
				4275.30.00	420 10 420W2GSZ
				8505.40.00	KZI - 4,5
818				4244.20.00	420 GFX420KR
				4257.30.00	420 10 420GSZ
				8505.40.00	KZI - 4,5
				4245.20.00	420 GFX420KR
T 811				3835.20.00	380 GF380
				3857.30.00	380 10 380W2GSZ
				8505.40.00	KZI - 4,5

Vehicle list



					
---	---	---	--	---	---

VAN HOOL







8..						
T 815 UL				4256.20.00	420 GMF420K	
				4275.30.00	420 10 420W2GSZ	
TD 824				4245.20.00	420 GFX420KR	
				4275.30.00	420 10 420W2GSZ	
				8505.40.00	KZI - 4,5	
TD 824 E				4244.20.00	420 GFX420KR	
				4257.30.00	420 10 420GSZ	
				8505.40.00	KZI - 4,5	
TD 827				4001.10.00	400 MFZ2/400X	- This part number includes one clutch disc
				4010.30.00	400 10 400WGVZ	- Loose clutch disc
				8916.40.00	KZIZ - 5	
				4011.30.00	400 6 400GVZ	- Contained in xxxx.10.00
815 A				4254.20.00	420 GF420X	- Engine code: MAN 240/280 PS
				42110.20.00	430 GMF430	- Engine code: MAN 240/280 PS
				42130.30.00	420 10 420GTZ	- Engine code: MAN 240/280 PS
				8514.40.00	KZI - 4,5	- Engine code: MAN 240/280 PS

9..						
915				4256.20.00	420 GMF420K	
				4266.30.00	420 10 420/210GSZ	
TD 924 Astromega TD 927 Astromega				4300.30.00	430 10 430GTZ	- GBox: ZF 8S-180
				8905.40.00	KZIZ - 5	- GBox: ZF 8S-180
T 911 Alicron T 915 Acron T 915 Alicron T 916 Altano T 917 Acron T 917 Altano T 917 Astron T 918 Altano				4036.30.00	400 10 400 WGTZ	- Engine code: D2866LOH29 - GBox: ZF 8S-180

































VOLVO

B 6 11.91 -						
B 6 / B 6 BLE B6R, B6LE	11.91 - 11.91 -	D6A180 D6A210 TD 63 E TD 63 ES		5901.40.00	KZA - 4	- From chassis no.: 5000 - Engine code: TD 63 E
B 6 , F, FA	12.78 -			7906.40.00	KZA-4	- Engine code: TD 60
B 609 - B 7000						
B 609 B 610	12.78 - 12.78 -			7906.40.00	KZA-4	- Engine code: TD 60

Vehicle list

					
---	---	---	--	---	---

VOLVO

B 7		01.92 -			
B 7			 3800.90.10  3860.20.00  3886.30.00  5902.40.00	380 10 GM380K 380GSZ KZA - 4	- From chassis no.: 20000->
			 8925.40.00	KZISZ-5	
			 8946.46.00	KZIZ-5	
B7R / B7R LE		D7A285 D7B230 D7B260 D7C275 D7C290 D7C300 D7C310	 4337.60.00	430 MFZ430	- From chassis no.: 2164-> - GBox: S6-85 - GBox: 6S-1380BD
			 4304.26.00	430 MFZ430	- To chassis no.: 2164-> - GBox: S-85 - Contained in xxxx.60.00 - GBox: 6S_1380BD
			 4322.30.00	10 430WGTZ	- From chassis no.: 2164-> - GBox: S6-85 - GBox: 6S-1380BD
			 4333.60.00	430 MFZ430	- From chassis no.: 2164-> - GBox: S6-90
			 4304.20.00	430 MFZ430	- From chassis no.: 355807-> - GBox: S6-820, S6-1550
			 4300.90.21  4332.60.00  4323.30.00	430 10 MFZ430 430WGTZ	- To chassis no.: ->6485 - GBox: EGS-V, EGS-VR
			 4332.60.00	430 MFZ430	- To chassis no.: 6486-> - GBox: EGS-V, EGS-VR
			 4325.30.00	430 24 430WGTZ	- From chassis no.: 6486-> - GBox: EGS-V, EGS-VR
			 8925.40.00	KZISZ-5	
			 8946.46.00	KZIZ-5	
			B 7	01.98 -	D7E290
 4300.90.21  4332.60.00  4323.30.00	430 10 MFZ430 430WGTZ	- GBox: R/SR1400			
 8925.40.00	KZISZ-5				
 8946.46.00	KZIZ-5				
B 9					
B 9 M	01.79 -		 3800.90.48  3860.20.00  3886.30.00  7802.40.00	380 10 GM380K 380GSZ KZA - 4	- To chassis no.: ->11499 - Chassis no.: 11540-11643 - GBox: S-65
			 4200.90.01  4203.20.00  4254.30.00  5901.40.00	420 10 G420KR 420GSZ KZA - 4	- To chassis no.: ->11499 - GBox: S6-80
			 8946.46.00	KZIZ-5	
			 8925.40.00	KZISZ-5	

Vehicle list

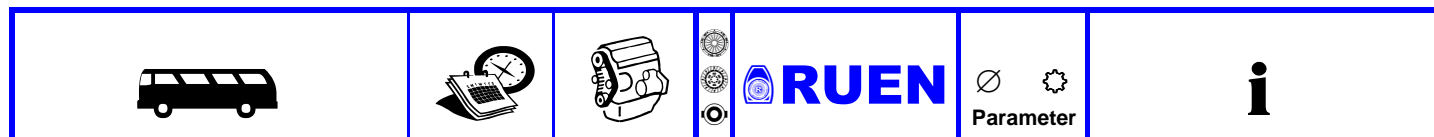

VOLVO







B 9

B 9, 18t, 4x2	09.05 -	G9A260		4336.60.00 ⊕	430 MFZ430	- GBox: ZF6S-1600
B 9, 26t, 6x2	09.05 -	D9B260		4331.30.00	430 10 430WGTZ	- GBox: ZF6S-1600
B 9, 18t, 4x2	09.05 -	D9B310		4300.90.16 ⊕	430 24	- GBox: EGS-V / EGS-VR
B 9, 26t, 6x2	09.05 -	D9B360		4332.60.00	MFZ430	
B 9, 18t, 4x2	09.05 -	G9A300		4325.30.00	430WGTZ	
B 9, 26t, 6x2	09.05 -			4329.30.00	430 24 430WGTZ	- GBox: AT2412C
B 9, 18t, 4x2	09.05 -			8641.47.00	PHIS-6/38	- GBox: AT2412C
B 9, 26t, 6x2	09.05 -			8946.46.00	KZIZ-5	
				8925.40.00	KZISZ-5	































B 10

B 10 B		DH10A		4332.60.00 ⊕	430 MFZ430	- To chassis no.: ->393 - GBox: G7-EGS, G8-EGS - GBox: VT2412B
B 10 BLE		GH10A,B,C		4331.30.00	430 10 430WGTZ	- To chassis no.: ->393 - GBox: G7-EGS, G8-EGS
		THD101G		4304.26.00 ⊖	430 MFZ430	- To chassis no.: ->393 - GBox: G7-EGS, G8-EGS - Contained in xxxx.60.00
		THD102K		4300.90.33 ⊕	430 10	- To chassis no.: 394->
		THD103K		4332.60.00	MFZ430	- GBox: G7-EGS, G8-EGS
		THD104K		4331.30.00	430WGTZ	
				4337.60.00	430 MFZ430	- To chassis no.: 7015-> - GBox: S6-85
				4322.30.00	10 430WGTZ	- From chassis no.: 7015-> - GBox: S6-85
				8946.46.00	KZIZ-5	
				8925.40.00	KZISZ-5	

Vehicle list

					
---	---	---	--	---	---

VOLVO

B 10					
B 10 M	01.94 -	THD 100 DC	 3500.90.01	350 10	- Chassis no.: 11500-11540 - Chassis no.: 11643-27774 - GBox: S6-90
			 3511.10.00	GF2/350	
			 3590.30.00	350GSZ	
			 5902.40.00	KZA - 4	
			 4200.90.01	420 10	- GBox: S6-80, S6-90
			 4203.20.00	G420KR	
			 4254.30.00	420GSZ	
			 5901.40.00	KZA - 4	
			 3515.10.00	350	- Chassis no.: 11500-11540 - Chassis no.: 11643-27774 - GBox: S6-90 - This part number includes one clutch disc
				GF2/350	
			 3562.30.00	350 10	- Loose clutch disc - Chassis no.: 11500-11540 - Chassis no.: 11643-27774 - GBox: S6-90
				350GSZ	
 3515.50.00	350	- Contained in xxxx.10.00 - Chassis no.: 11500-11540 - Chassis no.: 11643-27774 - Vehicles with double disc clutch			
	GF2-350				
 4300.90.21 ⊕	430 10	- GBox: G7-EGS - To chassis no.: ->25456			
 4332.60.00	MFZ430				
 4323.30.00	430WGTZ				
 4304.26.00 ⊖	430	- Contained in xxxx.60.00 - To chassis no.: ->25456 - GBox: G7-EGS			
	MFZ430				
 4332.60.00 ⊕	430	- To chassis no.: 25457-> - GBox: G7-EGS			
	MFZ430				
 4331.30.00	430 10	- From chassis no.: 25457-> - GBox: G7-EGS			
	430WGTZ				
 8925.40.00	KZISZ-5				
 8946.46.00	KZIZ-5				
B 10 M	01.94 -	THD 100 DA THD 100 EA	 3528.30.00	350 10	- Chassis no.: 20001-25456 - GBox: G7-EGS
				350GSZ	
			 4337.60.00	430	- From chassis no.: 52526-> - GBox: S6-85
				MFZ430	
			 4322.30.00	10	- From chassis no.: 52526-> - GBox: S6-85
	430WGTZ				
 8925.40.00	KZISZ-5				
 8946.46.00	KZIZ-5				
B 10 R	01.78 -		 4200.90.01	420 10	- GBox: S6-80
			 4203.20.00	G420KR	
			 4254.30.00	420GSZ	
			 5901.40.00	KZA - 4	
 8925.40.00	KZISZ-5				
 8946.46.00	KZIZ-5				

Vehicle list

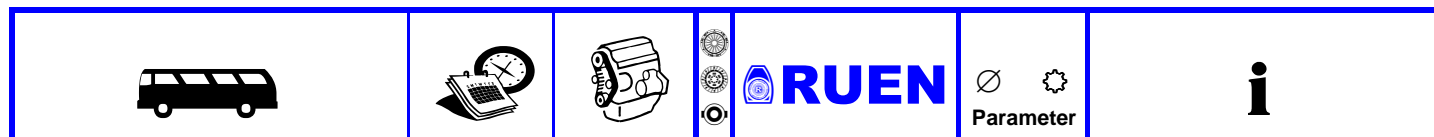

VOLVO







B11R 09.11 -

B11R, 19t, 4x2	09.11 -	D11C330	⊕	8641.47.00	PHIS-6/38	- GBox: AT 2412 E+F
B11R, 26.50t, 6x2	09.11 -	D11C370				
B11R, 19t, 4x2	09.11 -	D11C410				
B11R, 26.50t, 6x2	09.11 -	D11K380				
B11R, 19t, 4x2	09.11 -	D11K430				
B11R, 26.50t, 6x2	09.11 -	D11K460				
B11R, 19t, 4x2	09.13 -					
B11R, 26.50t, 6x2	09.13 -					
B11R, 19t, 4x2	09.13 -					
B11R, 26.50t, 6x2	09.13 -					

B 12 01.92 -















B 12, 262kW	01.92 -	TD 122 FH	⊕	4332.60.00	⊕	430 MFZ430	
			⊕	4331.30.00		430 10 430WGTZ	
B 12, 291/298kW	01.92 -	TD 122 FL TD 123 ES	⊕	4332.60.00	⊕	430 MFZ430	- GBox: G7-EGS
			⊕	4331.30.00		430 10 430WGTZ	- GBox: G7-EGS
			⊖	4304.26.00	⊖	430 MFZ430	- Contained in xxxx.60.00 - GBox: G7-EGS
			⊕	8946.46.00		KZIZ-5	
			⊕	8925.40.00		KZISZ-5	
B 12, 309kW	01.92 -	D12A420	⊕	4332.60.00	⊕	430 MFZ430	
			⊕	4331.30.00		430 10 430WGTZ	
B 12 M (Chassis), 250/309kW		DH12D340 DH12D380 DH12D420	⊕	4300.90.16	⊕	430 24 MFZ430	- GBox: EGS-V, EGS-VR
			⊕	4332.60.00		430WGTZ	
			⊕	4325.30.00		430WGTZ	
			⊕	4336.60.00	⊕	430 MFZ430	- GBox: 6S-1600
			⊕	4331.30.00		430 10 430WGTZ	- GBox: 6S-1600
			⊖	4304.26.00	⊖	430 MFZ430	- GBox: 6S-1600 - Contained in xxxx.60.00 - GBox: VT2412B
			⊕	4300.90.62	⊕	430 24 MFZ430	- GBox: VT2412B
			⊕	4336.60.00		430WGTZ.	
			⊕	4329.30.00		430WGTZ.	
			⊕	8925.40.00		KZISZ-5	
			⊕	8946.46.00		KZIZ-5	
B12	02.06 -	DH12E340	⊕	4300.90.16	⊕	430 24 MFZ430	
			⊕	4332.60.00		430WGTZ	
			⊕	4325.30.00		430WGTZ	
			⊕	4300.90.62	⊕	430 24 MFZ430	
			⊕	4336.60.00		430WGTZ.	
			⊕	4329.30.00		430WGTZ.	
			⊕	8641.47.00		PHIS-6/38	
B12			⊕	4054.30.00		400 10 400WGTZ	- Engine code: TD 73 E

Vehicle list









					
---	---	---	--	---	---

VOLVO









B 51 - B 59

B 57, BB 57	01.72 -		 3800.90.48  3860.20.00  3886.30.00  7802.40.00	380 10 GM380K 380GSZ KZA - 4	- Chassis no.: ->9780 - GBox: S6-65
B 57, BB 57			 3860.20.00	380 GM380K	- From chassis no.: 9781-> - GBox: S6-65
			 3886.30.00	380 10 380GSZ	- From chassis no.: 9781 - From chassis no.: 1563-> - GBox: S6-65 - GBox: K 191
			 3804.20.00	380 G380KR	- From chassis no.: 1563-> - GBox: K 191
B 58			 4200.90.01  4203.20.00  4254.30.00  5901.40.00	420 10 G420KR 420GSZ KZA - 4	- GBox: ZF S6-80
			 4200.90.72  4211.20.00  4254.30.00  8900.40.00	420 10 G420KR 420GSZ KZI - 5	- GBox: K 191







C 10 M

C 10 M	01.84 -		 3500.90.51  3516.10.00  3562.30.00  5902.40.00	350 10 GF2/350 350GSZ KZA - 4	- GBox: S6-90
			 3515.10.00	350 GF2/350	- GBox: S6-90 - This part number includes one clutch disc
			 3559.30.00	350 10 350GSZ	- Loose clutch disc - GBox: S6-90
			 3562.30.00	350 10 350GSZ	- Loose clutch disc - GBox: S6-90
			 5902.40.00	KZA - 4	- GBox: S6-90
			 3515.50.00	350 GF2-350	- GBox: S6-90

8500















8500	04.01 - 04.01 - 04.01 -	DH12D340 DH12D380 DH12D420	 4300.90.16 ⊕  4332.60.00  4325.30.00	430 24 MFZ430 430WGTZ	- GBox: EGS-VR
			 4304.26.00 ⊖	430 MFZ430	- GBox: EGS-VR - Contained in xxxx.60.00 - GBox: ZF 6S-1600 - GBox: VT-2412B
			 4300.90.62 ⊕  4336.60.00  4329.30.00	430 24 MFZ430 430WGTZ.	- GBox: VT2412B
			 4336.60.00 ⊕	430 MFZ430	- GBox: ZF 6S-1600
			 4331.30.00	430 10 430WGTZ	- Vehicles with double disc clutch

Vehicle list













					
---	---	---	--	---	---

VOLVO





8700

8700		DH12D340 DH12D380 DH12D420	 4300.90.16 ⊕	430 24	- GBox: EGS-VR
			 4332.60.00	MFZ430	
			 4325.30.00	430WGTZ	
			 4304.26.00 ⊖	430	- GBox: EGS-VR - Contained in xxxx.60.00 - GBox: ZF 6S-166 - GBox: VT-2412B
			 4300.90.62 ⊕	430 24	- GBox: VT-2412B
			 4336.60.00	MFZ430	
			 4329.30.00	430WGTZ.	
			 4336.60.00 ⊕	430	- GBox: ZF 6S-1600
			 4331.30.00	430 10	- GBox: ZF 6S-1600
8700, 4x2		D7C270 D7C310	 4300.90.21 ⊕	430 10	- To chassis no.: ->6485
			 4332.60.00	MFZ430	
			 4323.30.00	430WGTZ	
			 4332.60.00 ⊕	430	- From chassis no.: 6486-> - GBox: EGS-VR
			 4325.30.00	430 24	- From chassis no.: 6486-> - GBox: EGS-VR
			 4304.26.00 ⊖	430	- GBox: EGS-VR - Contained in xxxx.60.00
				MFZ430	







9700 04.01 -

9700, 250kW, 4x2 9700, 250kW, 6x2/4 9700, 280kW, 4x2 9700, 280kW, 6x2/4 9700, 309kW, 4x2 9700, 309kW, 6x2/4	04.01 - 10.01 - 04.01 - 10.01 - 04.01 - 10.01 -	DH12D340 DH12D380 DH12D420 DH12E340 DH12E380 DH12E420	 4300.90.16 ⊕	430 24	- GBox: EGS-VR
			 4332.60.00	MFZ430	
			 4325.30.00	430WGTZ	
			 4304.26.00 ⊖	430	- GBox: EGS-VR - Contained in xxxx.60.00 - GBox: ZF 6S-1600 - GBox: VT-2412B
			 4300.90.62 ⊕	430 24	- Vehicles with double disc clutch
			 4336.60.00	MFZ430	
			 4329.30.00	430WGTZ.	
			 4336.60.00 ⊕	430	- Vehicles with double disc clutch
			 4331.30.00	430 10	- GBox: ZF 6S-1600
9700, 338kW, 4x2 9700, 338kW, 6x2/4	10.07 - 10.07 -	DH12E460	 4329.30.00	430 24	- Engine code: DH12E460
			 8641.47.00	PHIS-6/38	- Engine code: DH12E460
9700, 309kW, 4x2 9700, 309kW, 6x2/4 9700, 338kW, 4x2 9700, 338kW, 6x2/4	01.09 - 01.09 - 01.09 - 01.09 -	D13C420 D13C460	 4398.30.00	430 24	- Engine code: D12C420
			 8641.47.00	PHIS-6/38	- Engine code: D12C420
				430WGTZ	











9900 10.01 -

9900, 309kW, 12100cc, 4x2	10.01 -	DH12D420 DH12E420	 4300.90.16 ⊕	430 24	- GBox: EGS-VR
			 4332.60.00	MFZ430	
			 4325.30.00	430WGTZ	
			 4304.26.00 ⊖	430	- GBox: EGS-VR - Contained in xxxx.60.00 - GBox: VT-2412B
				MFZ430	





Vehicle list

					
---	---	---	--	---	---





VOLVO

9900		10.01 -				
9900, 309kW, 12100cc, 6x2	10.01 -	DH12D420 DH12E420		4300.90.16 ⊕	430 24	- GBox: EGS-VR
				4332.60.00 4325.30.00	MFZ430 430WGTZ	
				4300.90.62 ⊕	430 24	- GBox: VT-2412B
				4336.60.00 4329.30.00	MFZ430 430WGTZ.	
				4304.26.00 ⊖	430	- GBox: EGS-VR
				MFZ430	430WGTZ	- GBox: VT2412B - Contained in xxxx.60.00
9900, 309kW, 12800cc, 4x2	01.09 -	D13C420		4398.30.00	430 24	- Engine code: D12C420
9900, 309kW, 12800cc, 6x2/4	01.09 -	D13C460			430WGTZ	
9900, 338kW, 12800cc, 4x2	01.09 -			8641.47.00	PHIS-6/38	- Engine code: D12C420
9900, 338kW, 12800cc, 6x2/4	01.09 -					
9900, 338kW, 12100cc, 4x2	10.07 -	DH12E46		4329.30.00	430 24	- Engine code: DH12E460
9900, 338kW, 12100cc, 6x2/4	10.07 -	0			430WGTZ.	
				8641.47.00	PHIS-6/38	- Engine code: DH12E460







YUTONG

ZK						
ZK 6100 HB				4312.30.00	430 10	- Engine code: C245-20
ZK 6118 HGA					430W2GTZ	- GBox: Qijiang QJ805, Qijiang QJ1205
ZK 6120 HA				42111.20.00	430	- Engine code: C245-20
					GMF430	- GBox: Qijiang QJ805, Qijiang QJ1205
ZK 6831 HE				3952.20.00	395	- Engine code: EQB210-20
					MF395	- GBox: Qijiang QJ805
				3954.30.00	395 10	- Engine code: EQB210-20
					395WGTZ	- GBox: Qijiang QJ805

ZASTAVA



Zastava 30...40.8		10.78 -				
30 U-8	10.78 -			2402.20.00	240	
32 U-8	10.78 - 12.80				MF240	
32 U-8S	10.78 - 12.80			2402.30.00	240 10	
35 U-8	10.78 -				240PSD	
35 U-8S	09.80 -					
40 U-8	10.78 -					
40 U-8H	09.80 -					
28-8	01.81 -					
30-8, A	09.84 -					
32-8	01.81 -					
35-8, A	10.81 -					
40-8, A	10.81 -					
Zastava 617/619						
Z 617 N				2514.20.00	250	
Z 617 K					H250K	
Z 619 N				2514.30.00	250 10	
Z 619 K					250CBL	
Z 624 N				5800.40.00	KZA - 2	
Z 624 K						
Z 630 N						
Z 630 K						
Z 630 N, I, L, A						

Vehicle list

				RUEN	 Parameter	
---	---	---	---	-------------	--	---

ZASTAVA

Zastava 635/640

Z 635 N, D, A Z 640 N, D, A Z 645 N, D, A Z 650 N, D, A				2810.20.00	280 H280K	
				2810.30.00	280 10 280CBL	
				6200.40.00	KZ - 4	

Arithmetical list

Reference	Parameter	Hub profile	Manufacturer	Page
1800.90.02			BARKAS	1
1801.20.00	T180120		BARKAS	1
1801.30.00	180DE2R	18,27X20,7-24Z	BARKAS	1
2000.90.19			RENAULT	87
2000.90.36			RENAULT	87
2000.90.40			RENAULT	87 88
2023.20.00	DB200		RENAULT	87
2034.30.00	200CE	20X21,91-26Z	RENAULT	87
2042.20.00	CP20		RENAULT	87 88
2045.30.00	200D	21,38X24,14-21Z	RENAULT	87
2080.30.00	200VTB	21,4x24,3-21N	RENAULT	87 88
2150.90.06			MERCEDES-BENZ	48
2150.90.07			RENAULT	87
2150.90.10			FORD	12
2150.90.16			PEUGEOT	87
2150.90.18			FIAT	11 12
			PEUGEOT	87
2150.90.42			RENAULT	87 88
2159.30.00	215CE	24,4X29X2,5-10Z	MERCEDES-BENZ	48
2171.20.00	MF215K		FORD	12
2172.30.00	215D	23,49X26,01-23Z	FORD	12
2178.30.00	215CE	21,4X24,1-21Z	FIAT	11 12
			PEUGEOT	87
			RENAULT	87 88
2185.20.00	CP215		FIAT	11 12
			MERCEDES-BENZ	48
			PEUGEOT	87
			RENAULT	87 88
2280.90.02			MERCEDES-BENZ	48 49
2280.90.03			MERCEDES-BENZ	48 49
2280.90.04			MERCEDES-BENZ	48
2281.30.00	228PSD	23X29-10Z	MERCEDES-BENZ	48 49
2282.20.00	M228KR		MERCEDES-BENZ	48 49 54
				55
2283.20.00	M228KR		MERCEDES-BENZ	48 49
			NEOPLAN	82
2306.30.00	228GSB	23X4X27-10Z	MERCEDES-BENZ	48 49 54
				55
2307.30.00	228CB	23X4X29-10Z	MERCEDES-BENZ	48 49
2350.90.01			IVECO	18
2353.20.00	MFZ235		IVECO	18
2354.30.00	235CBL	23X29-10Z	IVECO	18
2400.90.04			FORD	12
2400.90.05			MERCEDES-BENZ	66
2400.90.06			FORD	12 13
2402.20.00	MF240		ZASTAVA	105 634
2402.30.00	240PSD	23X29X-10Z	ZASTAVA	105 634
2403.20.00	MF240		FORD	12 13
2413.30.00	240TD	23X26-23Z	FORD	12 13

Arithmetical list

Reference	Parameter	Hub profile	Manufacturer	Page
2418.30.00	240CTB	26x29-26N	MERCEDES-BENZ	47 66
2500.90.01			MERCEDES-BENZ	54 55 62 63
2507.20.00	HBX250		MERCEDES (TÜRKİYE)	46
			MERCEDES-BENZ	54 55 62 63
2514.20.00	H250K		IVECO	16 19 57 88 125
			ZASTAVA	105 635
2514.30.00	250CBL	1 1/4"-10Z	IVECO	16 19 57 88 121 125
			ZASTAVA	105 635
2518.20.00	G250		OTOKAR (TÜRKİYE)	86
2518.30.00	250GSZ	26X32-10Z	OTOKAR (TÜRKİYE)	86
2525.20.00	MF250		RENAULT TRUCKS	88 473 486 509 512 525 527 529 530
2528.30.00	250BHZX	26X32-10Z	MERCEDES (TÜRKİYE)	46
			MERCEDES-BENZ	54 55 62 63
2650.90.01			IVECO	18
2650.90.15			IVECO	18
2651.20.00	MF265		IVECO	18
2654.20.00	MF270		IVECO	16 18 57
2655.30.00	* 265TB	23x29-10N	IVECO	18
2656.30.00	* 270CTB	26x32-10N	IVECO	16 18 57
2658.20.00	MFZ265		IVECO	18
2665.30.00	* 260 CTD	26X29-26N	MERCEDES-BENZ	47
2678.30.00	* 265VTP	23x29-10N	IVECO	18
2800.90.31			IVECO	18
2802.20.00	G280		TAM	94
2803.30.00	280BHZ	26X32-6	TAM	94
2809.20.00	H280		IVECO	16 17 19
2810.20.00	H280K		IVECO	16 17 18 19 20 56 57 88 115
			ZASTAVA	106
2810.30.00	280CBL	1 3/8"-10Z	IVECO	16 17 18 19 20 56 57 88 115
			ZASTAVA	106
2812.20.00	HVB280		MERCEDES-BENZ	55 64 66
2812.30.00	280Z	28X35X4-10	MERCEDES-BENZ	55 64 66
2813.20.00	HVB280		MERCEDES-BENZ	54
2813.30.00	280BHZ	28X35-10Z	MERCEDES-BENZ	64
2819.30.00	280GSZ	26X32-10Z	MAGIRUS-DEUTZ	22 134
2821.20.00	MF280K		TAM	95
2821.30.00	280GTZ	32X40-10	TAM	95
2822.30.00	280GTZ	28X35-10Z	MERCEDES-BENZ	47 50 54 55 62 66
2837.20.00	MFZ280		MERCEDES-BENZ	47 62
2845.20.00	HVB280		MERCEDES-BENZ	50 55
2861.20.00	MFZ280		IVECO	18
2867.30.00	* 280 VBL	23x30,55x10N	IVECO	18
2953.20.00	GF295		MERCEDES-BENZ	50 51

Arithmetical list

Reference	Parameter	Hub profile	Manufacturer	Page
2954.20.00	GF295		MERCEDES-BENZ	65
2954.30.00	295BHZ	28X35-10Z	MERCEDES-BENZ	50 65
2955.20.00	GF295		MAGIRUS-DEUTZ	22 23 24 138
3100.90.12			MERCEDES-BENZ	50 57 63 64
			NEOPLAN	68
3100.90.13			IVECO	16 17 116
3101.20.00	GFX310		MERCEDES (TÜRKİYE)	46
			MERCEDES-BENZ	50 64 65
3102.30.00	310GSZ	32X40-10	TAM	95
3103.20.00	GF310KR		TAM	95
3104.30.00	310GSBL	28X35-10	MERCEDES (TÜRKİYE)	46
3108.30.00	310GSZ	10	MAGIRUS-DEUTZ	23 134
3113.30.00	310GSBL	1 1/2"-10Z	IVECO	16 17 71 87 115 116
			MAGIRUS-DEUTZ	23 24
3120.20.00	GFX310		MERCEDES-BENZ	50 51 64 65
			NEOPLAN	73 74 78 81
3122.20.00	GFX310		EOBUS	4
3124.30.00	310GSBL	28X35-10Z	MERCEDES-BENZ	50 51 64 65
			NEOPLAN	73 74 78 81
3126.30.00	310GSBL	28X35-10Z	EOBUS	4
			IKARUS	14
			MERCEDES-BENZ	47 62 63 64
3131.20.00	G310		MAGIRUS-DEUTZ	23 134
			MAN	44
3133.30.00	310GSBL	1 1/2"- 10N	OTOKAR (TÜRKİYE)	86
			OTOYOL (TÜRKİYE)	87
3136.30.00	310WGSZ	28X35-10	MERCEDES-BENZ	50 57 63 64
			NEOPLAN	68
3140.30.00	310W2GSZ	1 1/2"-10Z	IVECO	19 20
			MAGIRUS-DEUTZ	23
			TAM	96
3162.20.00	MF310		IVECO	19 20
			MAGIRUS-DEUTZ	23
3164.20.00	MF310		MERCEDES-BENZ	50 57 63 64
			NEOPLAN	68
			TAM	96
3166.20.00	MF310		MAGIRUS-DEUTZ	24
3169.20.00	MF310		IVECO	16 17 71 87 116
3174.20.00	MF310		OTOKAR (TÜRKİYE)	86
3176.20.00	MFZ310		IKARUS	14
			MERCEDES-BENZ	47 62 63
3188.20.00	MFZ 310		OTOYOL (TÜRKİYE)	87
3205.40.00	KZIS - 0		FORD	12 13
3206.40.00	KZIS - 1		FORD	12
3209.40.00	KZAS - 1		MERCEDES-BENZ	48

Arithmetical list

Reference	Parameter	Hub profile	Manufacturer	Page		
3211.40.00	KZIS - 0		FIAT	11	12	
			PEUGEOT	87		
3212.40.00	KZI - 0		BARKAS	1		
3214.40.00	KZI/T - 1		MERCEDES-BENZ	48 55	49	54
3216.40.00	KZAS - 0		RENAULT	87	88	
3224.40.00	KZAS - 00		RENAULT	87		
3233.40.00	KZAS - 0B		RENAULT	87		
3300.20.00	GFM330		EVOBUS	6	7	
			MAGIRUS-DEUTZ	25		
			MERCEDES-BENZ	63		
			NEOPLAN	82		
3300.30.00	330GSZ	28X35-10	NEOPLAN	82		
3300.90.04			MERCEDES-BENZ	63		
3300.90.08			MAN	30		
3304.20.00	GMF330		IVECO	20		
3305.20.00	GMF330		MERCEDES-BENZ	50	57	63
3306.30.00	330GSZ	1 3/4"-10C	EVOBUS	6	7	
3308.30.00	330GSZ	1 1/2"-10C	EVOBUS	7		
			IVECO	20		
3309.30.00	330GSZ	1 1/2"-10	MAN	30		
3313.20.00	MFZ330		MAN	30		
3325.30.00	330WGSZ	28X35-10Z	MERCEDES-BENZ	50	57	63
3328.30.00	330WGSZ	1 1/2"-10N	MAGIRUS-DEUTZ	25		
3500.90.01			VOLVO	101		
3500.90.04			MAN	39		
3500.90.11			MERCEDES-BENZ	65		
3500.90.42			RENAULT TRUCKS	89		
3500.90.51			VOLVO	103		
3503.20.00	G350KR		TAM	95		
3503.30.00	350GSZ	1 3/4"-10Z	TAM	95		
3505.20.00	G350KR		IKARUS	14		
			MAGIRUS-DEUTZ	22 25 133 137	23 27	24 29 135
			MAN	44		
			MAN (TÜRKİYE)	45		
			MERCEDES-BENZ	55	64	66
			TAM	95		
			EVOBUS	4	5	6
			NEOPLAN	70 76	74 78	75 81
			MAN	39	40	
			VOLVO	101		
3510.30.00	350W2GSZ	1 3/4"-10Z	MAN	39	40	
3511.10.00	GF2/350		VOLVO	101		
3512.30.00	350W2GSZ	32X40-10Z	MAGIRUS-DEUTZ	23	25	27
				134	145	
3515.10.00	GF2/350		VOLVO	101	103	
3515.50.00	GF2-350		VOLVO	101	103	
3516.10.00	GF2/350		VOLVO	103		
3516.30.00	350WGSZ	32X40-10	IKARUS	14		
			MAN	44		

Arithmetical list

Reference	Parameter	Hub profile	Manufacturer	Page
3517.30.00	350WGSZ	1 3/4"-10Z	MAN	44
			MERCEDES-BENZ	51 64 65
3519.30.00	350GSZ	32X40-10Z	MAGIRUS-DEUTZ	22 23 24
				25 29 133
			MERCEDES (TÜRKİYE)	135 137 138
				46
3521.20.00	GF350KR		DAF	2
3522.20.00	GF350KR		MERCEDES (TÜRKİYE)	46
			MERCEDES-BENZ	50 51 65
3525.20.00	GF350KR		MERCEDES-BENZ	51
			NEOPLAN	74 75 78
				82
3528.30.00	350GSZ	2"-10Z	VOLVO	101
3552.30.00	350	32X40-10Z	MAGIRUS-DEUTZ	29
			MAN	44
			MERCEDES-BENZ	55 64 66
3559.30.00	350GSZ	1 3/4"-10Z	VOLVO	103
3562.20.00	GMF350		RENAULT TRUCKS	88
3562.30.00	350GSZ	1 3/4"-10Z	VOLVO	101 103
3563.20.00	GMF350		MAGIRUS-DEUTZ	22 23 24
				25 27 138
				143
3563.30.00	350GSZ	1 1/2"-10Z	DAF	2
			MAGIRUS-DEUTZ	24
			MAN	30
			NEOPLAN	73
3564.30.00	350GSZ	1 3/4"-10Z	MAGIRUS-DEUTZ	22 23 24
				25 27 138
				143
3565.20.00	GMF350		GÜLERYÜZ (TÜRKİYE)	13
			MAGIRUS-DEUTZ	24
3570.20.00	GMF350		MAGIRUS-DEUTZ	24
3570.30.00	350Z	36X45-10Z	RENAULT TRUCKS	88
3573.20.00	MF350		MAGIRUS-DEUTZ	24
			MAN	30 34 36
				38 39 40
			NEOPLAN	73
3574.20.00	14" MF 350		BMC (TÜRKİYE)	1
			OTOKAR (TÜRKİYE)	86
			RENAULT TRUCKS	88 89 483
				485 486 506
				509 510 511
				512 513 514
				515 530
			TEZELLER-TÜRKKAR (TÜRKİYE)	96
3575.30.00	350WGSZ	1 3/4"-10Z	MAN	44
			MERCEDES-BENZ	51
3576.30.00	350WGSZ	1 1/2"-10Z	GÜLERYÜZ (TÜRKİYE)	13
			MAN	30 34
3580.20.00	GMF350		MERCEDES-BENZ	64 65
3583.30.00	350GSZ	1 3/4"-10Z	MAGIRUS-DEUTZ	24
			MERCEDES-BENZ	64 65
			NEOPLAN	74 75 78
				82
3585.30.00	350GSZ	1 1/2"-10Z	MAGIRUS-DEUTZ	24

Arithmetical list

Reference	Parameter	Hub profile	Manufacturer	Page		
3587.30.00	350GSZ	1 1/2"-10Z	MAN	39		
			NEOPLAN	73		
			RENAULT TRUCKS	89		
3588.30.00	350GSZ	32X40-10	MAN	44		
			MERCEDES-BENZ	50	51	65
			NEOPLAN	74	75	76
				78	81	
			TAM	95		
3590.30.00	350GSZ	1 3/4"-10Z	VOLVO	101		
3596.30.00	350WGSZ	1 1/2"-10Z	MAN	34	36	38
				39	40	
3597.30.00	350 WGTZ	1 3/4 SAE 10C	MAN (TÜRKİYE)	45		
3598.30.00	350WGTZ	1 1/2 SAE 10C	OTOKAR (TÜRKİYE)	86		
			TEZELLER-TÜRKKAR (TÜRKİYE)	96		
3606.20.00	MF362		MERCEDES-BENZ	47	63	64
3607.30.00	362WGTZ	1 1/2"-10C	TEMSA (TÜRKİYE)	96		
3608.20.00	MF362		TEMSA (TÜRKİYE)	96		
3610.20.00	MFZ362		MAN	30		
3610.30.00	362GTZ	1 1/2-10N	MAN	30		
3620.90.01			MERCEDES-BENZ	63	64	
3620.90.02			MERCEDES-BENZ	47	63	
3620.90.10			MAN	30		
3627.30.00	362WGTB	36x40-18N	MERCEDES-BENZ	47	63	64
3800.90.10			VOLVO	99		
3800.90.48			VOLVO	99	103	
3800.90.52			BOVA	2		
3802.20.00	G380KR		TAM	96		
3802.30.00	380GSZ	1 3/4"-10Z	ENASA	4		
			TAM	96		
3804.20.00	G380KR		EVOBUS	4	5	11
			IVECO	18	20	21
			MAGIRUS-DEUTZ	25	26	27
				28	29	133
				138	139	142
			VOLVO	146		
	103					
3805.30.00	380WGSZ	32X40-10Z	MAGIRUS-DEUTZ	24	25	26
				27	28	138
3807.20.00	G380KR		EVOBUS	4	5	6
			MAGIRUS-DEUTZ	24	25	26
			MERCEDES-BENZ	55		
3810.20.00	G380KR		EVOBUS	4	5	6
			MAGIRUS-DEUTZ	26	138	139
				142		
			TAM	95		
38106.30.00	380WGTZ	1 3/4" SAE 10C	MERCEDES (TÜRKİYE)	46		
38115.30.00	380GSZ	1 3/4"-10Z	IVECO	20	21	
3812.30.00	380GSZ	36X45-10Z	IVECO	18	123	
			MAGIRUS-DEUTZ	25	26	27
				133	139	142
				145	146	
3816.30.00	380GSZ	1 3/4"-10Z	MAGIRUS-DEUTZ	26	28	138
				142	143	

Arithmetical list

Reference	Parameter	Hub profile	Manufacturer	Page		
3821.20.00	GF380KR		EVOBUS	5	6	7
				11		
			MERCEDES (TÜRKİYE)	46		
			MERCEDES-BENZ	52	54	65
			NEOPLAN	69	70	
3821.30.00	380GSZ	1 3/4"-10Z	MERCEDES-BENZ	54	64	
			NEOPLAN	69		
3822.20.00	GF380KR		MERCEDES-BENZ	64	65	
			SETRA	93		
3822.30.00	380GSZ	36X45-10Z	MERCEDES-BENZ	55		
			SETRA	93		
3829.20.00	GF380KR		DAF	3		
3831.30.00	380GSZ	32X40-10Z	MAN	44		
			MERCEDES (TÜRKİYE)	46		
			MERCEDES-BENZ	53		
3835.20.00	GF380		MAN	36	37	40
			RENAULT TRUCKS	89		
			VAN HOOL	97		
3852.30.00	380GS	1 3/4"-10Z	DAF	3		
3855.30.00	380GS	2"-10Z	DRÖGMÖLLER	3		
3857.10.00	GF2/380		DRÖGMÖLLER	3		
			EVOBUS	9		
3857.20.00	G380KR		DRÖGMÖLLER	3		
			EVOBUS	9		
3857.30.00	380W2GSZ	1 3/4"-10Z	MAGIRUS-DEUTZ	27	28	29
			MAN	36	37	40
			MERCEDES-BENZ	52		
			NEOPLAN	69	70	
			TAM	95		
			VAN HOOL	97		
3857.50.00	GF2/380		DRÖGMÖLLER	3		
			EVOBUS	9		
3860.20.00	GM380K		VOLVO	99	103	
3861.30.00	380W2GSZ	36X45-10Z	MAGIRUS-DEUTZ	26	27	139
				142	145	146
3866.20.00	GM380K		RENAULT TRUCKS	88	89	473
				480	482	484
				485	504	506
				510	512	526
				527	529	530
				531		
3868.20.00	15" GM380		BMC (TÜRKİYE)	1		
3870.30.00	380/210GSZ	1 3/4"-10Z	KAMAZ	21	22	
3878.20.00	GMF380		BOVA	2		
3882.10.00	GF2/380		DRÖGMÖLLER	3		
3882.20.00	GF2/380		DRÖGMÖLLER	3		
			NEOPLAN	67	73	
3882.50.00	GF2/380		DRÖGMÖLLER	3		
			EVOBUS	9		
			NEOPLAN	67	73	
3883.30.00	380GSZ	2"-10	DRÖGMÖLLER	3		
3884.30.00	15" 380GSZ	1 3/4" SAE 10C	BMC (TÜRKİYE)	1		
3886.30.00	380GSZ	1 3/4"-10Z	VOLVO	99	103	

Arithmetical list

Reference	Parameter	Hub profile	Manufacturer	Page		
⊗ 3888.30.00	380WGSZ	1 3/4"-10Z	EVOBUS	5	6	7
			MERCEDES-BENZ	11		
				65		
⊗ 3889.30.00	380GSZ	2"-10Z	NEOPLAN	67	73	
⊗ 3891.30.00	380GS	2"-10Z	NEOPLAN	67		
⊗ 3892.30.00	380GSZ	2"-10Z	DRÖGMÖLLER	3		
			EVOBUS	9		
⊗ 3893.10.00	GF2/380		NEOPLAN	67	73	
⊗ 3895.20.00	G380KR		MAGIRUS-DEUTZ	26	27	28
				133	142	143
				145		
⊗ 3897.30.00	380GSZ	1 3/4"-10Z	BOVA	2		
⊗ 3899.30.00	380GSZ	32X40-10Z	MAGIRUS-DEUTZ	25	133	138
⊗ 3951.20.00	MF395		KAMAZ	21	22	130
			MERCEDES-BENZ	60	62	
			NEOPLAN	73		
			TAM	95		
⊗ 3951.30.00	395WGTZ	1 3/4"-10Z	NEOPLAN	73		
			TAM	95		
⊗ 3952.20.00	MF395		YUTONG	105		
⊗ 3952.30.00	395WGTZ	1 1/2-10N	IVECO	19		
⊗ 3953.20.00	MF395		IVECO	19		
			KAMAZ	21	127	
⊗ 3954.30.00	395WGTZ	1 3/4"-10N	YUTONG	105		
⊗ 3961.30.00	395GTZ	36X40-18	MERCEDES-BENZ	60		
⊗ 3962.30.00	395GTZ	1 3/4"-10	KAMAZ	21	22	130
⊗ 4000.90.60	⊕		SCANIA	92		
⊗ 4000.90.61	⊕		SCANIA	92		
⊗ 4001.10.00	MFZ2/400X		VAN HOOL	98		
⊗ 4001.20.00	MFZ2/400X		NEOPLAN	69	70	71
				72	80	82
			VAN HOOL	98		
⊗ 4007.30.00	400WGTZ	2"-10N	RENAULT TRUCKS	89	90	
⊗ 4008.30.00	400 WGVZ	1 3/4" SAE 10C	MAN	30		
			MAN (TÜRKİYE)	45		
⊗ 4010.10.00	MFZ2/400X		NEOPLAN	69	70	71
				72	80	82
⊗ 4010.30.00	400WGVZ	2"-10Z	VAN HOOL	98		
⊗ 4011.30.00	400GVZ	73X83-6N	VAN HOOL	98		
⊗ 4020.30.00	400GVZ	2"-10Z	EVOBUS	9	11	
			NEOPLAN	69	70	71
				72	80	82
⊗ 4021.30.00	400GVZ	2"-10Z	EVOBUS	9	11	
			NEOPLAN	69	70	71
				72	80	82
⊗ 4036.30.00	400 WGTZ	2"-10N	VAN HOOL	98		
⊗ 4051.30.00	400WGVZ	46x50-24N	SCANIA	92		
⊗ 4052.30.00	400GVZ	41x45-22N	SCANIA	92		
⊗ 4054.30.00	400WGTZ	1 3/4"- 10N	VOLVO	102		
⊗ 4060.60.00	⊕	MFZ400X	SCANIA	92		
⊗ 4200.90.01			VOLVO	99	101	103

Arithmetical list

Reference	Parameter	Hub profile	Manufacturer	Page
4200.90.17			DRÖGMÖLLER	3
			NEOPLAN	70 71 72 74 75 76 77 78 79 80 81
			TAM	95
4200.90.22			BOVA	2
			VAN HOOL	97
4200.90.49			IVECO	19 20
4200.90.72			VOLVO	103
4200.90.77			SCANIA	92
4200.90.79	●		IVECO	20
4200.90.84	●		SCANIA	91 92
4201.20.00	G420KR		SCANIA	91
			TAM	95
4203.20.00	G420KR		VOLVO	99 101 103
4203.30.00	420GS	36X45-10Z	IKARUS	14
			MAN	44 45
			NEOPLAN	69 70 71 73 76 77 78 79 80 81
4205.20.00	G420KR		DAF	2
			MAN	37
			NEOPLAN	69 70 71 73 76 77 78 79 80 81
			VAN HOOL	96
4208.30.00	420GS	1 3/4"-10Z	DAF	2
			IKARUS	14
			IVECO	18 20 88 89 90 94 95 117 118 119 120 121 122 123 125
			NEOPLAN	67 69 82
			SCANIA	91
			VAN HOOL	96 97
4209.30.00	420GS	1 3/4"-10Z	NEOPLAN	71 77
42106.30.00	420WGTZ	46x50-24N	SCANIA	92
4211.20.00	G420KR		VOLVO	103
42110.20.00	GMF430		NEOPLAN	79
			VAN HOOL	98
42111.20.00	GMF430		YUTONG	105
42130.30.00	420GTZ	1 3/4" -10N	VAN HOOL	98
4215.30.00	420 GSZ	1 3/4" -10N	IKARUS (TÜRKİYE)	14
4221.30.00	420 GSZ	1 3/4" -10N	IKARUS (TÜRKİYE)	14
4222.20.00	GF420KR		IKARUS	14
			IKARUS (TÜRKİYE)	14
			MAGIRUS-DEUTZ	27 28 145 146
			MAN	35 37 44
			MERCEDES-BENZ	53 54
			VAN HOOL	96
4222.30.00	420BH	36x45-10N	MAN	37

Arithmetical list

Reference	Parameter	Hub profile	Manufacturer	Page		
4224.20.00	GF420KR		MAGIRUS-DEUTZ	29	144	145
				146		
			MAN	36	40	41
				44	45	
			TAM	95		
4225.20.00	GF420KR		EOBUS	5	6	7
				8	9	10
				11		
			MERCEDES-BENZ	51	53	66
			NEOPLAN	67	69	70
				71	72	74
				75	76	77
				78	79	80
			81	82		
		ÖSTERREICHISCHE AUTOMOBILFABRIK (ÖAF)	86			
4226.20.00	GF420KR		MAGIRUS-DEUTZ	27	28	145
				146	147	
			MAN	35	37	
			MERCEDES-BENZ	65		
		NEOPLAN	69			
4231.30.00	420GSZ	36X45-10N	EOBUS	6		
			NEOPLAN	77		
4234.20.00	GF420KR		IKARUS	14		
			MERCEDES-BENZ	52	54	65
			NEOPLAN	69		
4235.20.00	GF420KR		BOVA	2		
			DRÖGMÖLLER	3		
			EOBUS	5	6	7
				8	9	11
			IVECO	18	120	121
				123	125	
			MAGIRUS-DEUTZ	29	144	145
				146	147	
			MAN	36	41	44
				45		
			MAN (TÜRKIYE)	45		
			MERCEDES (TÜRKIYE)	46		
			MERCEDES-BENZ	51	52	53
				60	66	
			NEOPLAN	67	69	70
	71	72	74			
	75	76	77			
	78	79	80			
			81	82		
		ÖSTERREICHISCHE AUTOMOBILFABRIK (ÖAF)	86			
		SETRA (TÜRKIYE)	94			
		TAM	95			
		VAN HOOL	97			
4235.30.00	420/210GS	1 3/4"-10Z	SCANIA	91	92	
4236.20.00	GF420KR		IVECO	18	19	20
				95	112	117
				118	119	121
				122	123	124
				125	126	
4236.30.00	420/210GSZ	36X45-10Z	MAGIRUS-DEUTZ	27	28	144
				145	146	147
				148		
4237.20.00	GF420KR		IKARUS	14		
			MAGIRUS-DEUTZ	28	29	142
				143		
		MERCEDES-BENZ	52	54		

Arithmetical list

Reference	Parameter	Hub profile	Manufacturer	Page		
4244.20.00	GFX420KR		EOBUS	6	7	8
				9		
			MAN	35	36	37
				38	40	41
			MERCEDES-BENZ	51	53	59
				60		
			NEOPLAN	67	69	70
				72	73	75
				76	77	79
				80	81	
	TAM	95				
	VAN HOOL	97	98			
4244.30.00	420/210GSZ	1 3/4"-10Z	BOVA	1	2	
			SCANIA	92		
			VAN HOOL	97		
4245.20.00	GFX420KR		EOBUS	8		
			MAN	36	38	41
			VAN HOOL	97	98	
4248.20.00	GFX420KR		BOVA	2		
			SCANIA	92		
			VAN HOOL	97		
4249.30.00	420W2GSZ	1 3/4"-10Z	MAGIRUS-DEUTZ	26	28	29
			MAN	35	36	37
				38		
4250.20.00	GFX420KR		EOBUS	5	7	8
				9	11	
4250.30.00	420WGSZ	1 3/4"-10Z	DAF	2	3	
			EOBUS	6	7	8
				9	10	
			MAN	36	38	40
				41		
			MERCEDES (TÜRKİYE)	46		
			NEOPLAN	70	71	72
				73	76	77
				79	81	
				SETRA (TÜRKİYE)	94	
	TAM	95	96			
4253.20.00	GFX420KR		IVECO	18	71	88
				89	91	124
				125		
			MAN	41		
			NEOPLAN	70	71	72
				73	76	77
				81		
	TAM	96				
4254.20.00	GF420X		BOVA	2		
			DRÖGMÖLLER	3		
			MERCEDES-BENZ	60		
			VAN HOOL	98		
4254.30.00	420GSZ	1 3/4"-10Z	VOLVO	99	101	103
4255.30.00	420GS	1 3/4"-10Z	NEOPLAN	67	69	81
				82		
			SCANIA	92		
4256.20.00	GMF420K		BOVA	1	2	
			NEOPLAN	71	72	
			SCANIA	92		
			VAN HOOL	97	98	

Arithmetical list

Reference	Parameter	Hub profile	Manufacturer	Page					
⊗ 4257.20.00	GMF420K		BOVA	1	2				
			DAF	2	3				
			VAN HOOL	97					
⊗ 4257.30.00	420GSZ	1 3/4"-10Z	BOVA	2					
			MAGIRUS-DEUTZ	29					
			NEOPLAN	70	71	72			
				73	76	77			
				81					
	VAN HOOL	97	98						
⊗ 4258.30.00	420GSZ	1 3/4"-10Z	BOVA	2					
			DRÖGMÖLLER	3					
			EVOBUS	6					
			MERCEDES-BENZ	60					
			NEOPLAN	69	70	71			
				72	74	75			
				76	77	78			
				79	80	81			
				82					
				TAM	95				
	VAN HOOL	97							
⊗ 4259.30.00	420GSZ	2"-10Z	BOVA	1	2				
⊗ 4261.20.00	GMF420K		SCANIA	91	92				
⊗ 4261.30.00	420GSZ	41X45-22Z	SCANIA	91	92				
⊗ 4263.20.00	GMF420K		SCANIA	91	92				
⊗ 4264.20.00	GFM420K		ENASA	4					
⊗ 4265.30.00	420GSZ	1 3/4"-10Z	IVECO	19	20				
⊗ 4266.30.00	420/210GSZ	2"-10Z	VAN HOOL	98					
⊗ 4268.30.00	420GSZ	1 3/4"-10Z	IVECO	18	20	71			
				88	89	90			
				91	92	93			
				94	95	112			
				117	118	119			
				120	121	122			
				123	124	125			
				VAN HOOL	97				
			⊗ 4272.30.00	420WGSZ	1 3/4"-10Z	DRÖGMÖLLER	3		
						MAGIRUS-DEUTZ	28	29	147
MERCEDES-BENZ	51	52				53			
	66								
NEOPLAN	70	71				72			
	74	75	76						
	77	78	79						
	80	81							
⊗ 4275.30.00	420W2GSZ	1 3/4"-10Z	MAN	35	36	41			
			VAN HOOL	97	98				
⊗ 4277.20.00	GFX420KR		IVECO	20					
⊗ 4278.20.00	GFX420KR		IVECO	20					
			NEOPLAN	70	75				
⊗ 4278.30.00	420W2GSZ	1 3/4"-10Z	MERCEDES-BENZ	51	53	59			
				60					
			NEOPLAN	67	69	72			
				73	76	77			
	79	80	81						
⊗ 4279.30.00	420WGSZ	1 3/4"-10N	MERCEDES-BENZ	59	60				

Arithmetical list

Reference	Parameter	Hub profile	Manufacturer	Page
4281.30.00	420WGVZ	1 3/4"-10Z	EVOBUS	7 8 9
			MAN	35 36 37
				38 40 41
			MAN (TÜRKİYE)	45
			MERCEDES (TÜRKİYE)	46
			MERCEDES-BENZ	52 59 60
			65	
4282.30.00	420WGVZ	2"-10C	EVOBUS	6 8 9
			NEOPLAN	71 72
			SETRA (TÜRKİYE)	94
4283.30.00	420WGSZ	36X45-10Z	MAN	37 44
			ÖSTERREICHISCHE AUTOMOBILFABRIK (ÖAF)	86
4284.30.00	420WGSZ	2"-10N	MERCEDES-BENZ	59 60
4291.20.00	GTF420		MAN	38
4291.30.00	420GSZ	1 3/4"-10N	ENASA	4
4296.20.00	GF420		BOVA	2
4297.30.00	420GSZ	1 3/4"-10Z	MERCEDES-BENZ	53 54 59
				60
			NEOPLAN	69
			VAN HOOL	96
4298.20.00	GF420		IKARUS	14
			MAGIRUS-DEUTZ	26 28 29
				142 143 146
			147	
4299.30.00	420GSZ	2"-10	IVECO	18 126
4300.20.00	MFZ430		BMC (TÜRKİYE)	1
			MAN	33
			MERCEDES (TÜRKİYE)	46
4300.30.00	430GTZ	2"-10Z	MAN	33 38
			NEOPLAN	66 67 68
				82 83
			VAN HOOL	98
4300.90.01			MERCEDES-BENZ	56 66
4300.90.03			MAN	31 32 33
				42 43 44
4300.90.05			MAN	30 35 37
				40 42 43
4300.90.09			SCANIA	91
4300.90.105			NEOPLAN	68 82 83
4300.90.11	⊕		SCANIA	91
4300.90.12			MAN	31 33
			NEOPLAN	83 84
4300.90.13			MAN	45
			NEOPLAN	68
4300.90.16	⊕		VOLVO	100 102 103
				104 105
4300.90.18			MERCEDES-BENZ	52 58
4300.90.180	■		EVOBUS	11
			MERCEDES-BENZ	57 61 62
			NEOPLAN	68 86
			SETRA	93 94
4300.90.182	■		MAN	31 43
			NEOPLAN	67 85 86
4300.90.183	■		MAN	32 42
			NEOPLAN	85 86

Arithmetical list

Reference	Parameter	Hub profile	Manufacturer	Page		
4300.90.184			MAN	32	42	43
				44		
4300.90.185			NEOPLAN	84	85	86
4300.90.21			MAN	34	35	
4300.90.30			NEOPLAN	68		
4300.90.33			VOLVO	99	101	104
4300.90.34			MERCEDES-BENZ	53	56	58
4300.90.405				66		
4300.90.44			VOLVO	100		
4300.90.47			VOLVO	99		
4300.90.48			VOBUS	10		
4300.90.49			SETRA	94		
4300.90.54			KAMAZ	21	127	129
4300.90.56			IRISBUS	15		
			RENAULT TRUCKS	89	90	
4300.90.57			RENAULT TRUCKS	89	90	
4300.90.58			MAN	30	31	45
4300.90.59			SCANIA	91		
4300.90.61			IRISBUS	15		
			RENAULT TRUCKS	90		
4300.90.62			MAN	45		
			NEOPLAN	67	68	69
4300.90.65				84	85	86
4300.90.66			VOBUS	4	11	
4300.90.67			MERCEDES-BENZ	61		
4300.90.68			VOBUS	10		
4300.90.69			MERCEDES-BENZ	53	56	58
				59		
4300.90.70			IRISBUS	15		
			RENAULT TRUCKS	90		
4300.90.71			IRISBUS	15		
			RENAULT TRUCKS	90		
4300.90.72			VOLVO	102	103	104
				105		
4300.90.73			KAMAZ	21	22	127
				129	130	
4300.90.74			RENAULT TRUCKS	89		
4300.90.75			MAN	31	33	
			NEOPLAN	83	84	

Arithmetical list

Reference	Parameter	Hub profile	Manufacturer	Page
4301.20.00	MFZ430		BOVA	1
			EVOBUS	8 10 11
			GÜLERYÜZ (TÜRKİYE)	13
			IVECO	18 20 71
				72 73 74
				75 76 77
				78 79 80
				81 82 86
				96 99 102
				103 106 109
				110 111 120
				122 124
			KAMAZ	21 22 129
			LAZ	22
			MAN	30 31 32
				33 34 35
				37 38 40
				41 42 43
				44 45
			MAN (TÜRKİYE)	45
			MAZ	45
			NEOPLAN	66 67 68
				70 71 72
				73 74 75
				76 77 78
				79 80 82
				83 84 85
SETRA	94			
SETRA (TÜRKİYE)	94			
TEMSA (TÜRKİYE)	96			
4303.20.00	MFZ430		BOVA	1
			DAF	2
			IVECO	19
			TEMSA	96
4304.20.00	MFZ430		EVOBUS	4 8 9
				11
			KAMAZ	21 22 127
				129 130
			MERCEDES (TÜRKİYE)	46
			MERCEDES-BENZ	49 51 52
				53 56 57
				58 59 61
				66
			SETRA	93
			SETRA (TÜRKİYE)	94
VOLVO	99			
4304.26.00	MFZ430		VOLVO	99 100 101
				102 103 104
				105
4304.30.00	430WGTZ	1 3/4"-10Z	MAN	33
			MERCEDES-BENZ	53 56 58
				66
4305.20.00	MFZ430		EVOBUS	9 10
			MERCEDES-BENZ	53 56 58
				61 66
			NEOPLAN	80
			TAM	95

Arithmetical list

Reference	Parameter	Hub profile	Manufacturer	Page
4305.30.00	430W2GTZ	2"-10Z	IRISBUS	15
			MAN	38
			MERCEDES-BENZ	49 57 61
			NEOPLAN	70 71 72
				73 74 75
				76 77 78
				79 80 82
			RENAULT TRUCKS	88 90
			SETRA (TÜRKİYE)	94
			TAM	95
			4306.30.00	430WGTZ
DAF	2			
EOBUS	5 8 9			
	10 11			
MAN	31 32 38			
	43			
MAN (TÜRKİYE)	45			
MERCEDES (TÜRKİYE)	46			
MERCEDES-BENZ	49 51 53			
	56 57 58			
	59 61 62			
	66			
NEOPLAN	76 77 78			
	79 80 84			
	85			
SETRA	93			
TEMSA	96			
TEMSA (TÜRKİYE)	96			
4307.20.00	MFZ430		EOBUS	8 10 11
			MERCEDES-BENZ	57 58 61
			SETRA	93 94
43100.20.00	MFZ430E	■*	EOBUS	11
			MAN	31 32 34
				35 42 43
				44
			MERCEDES-BENZ	57 61 62
			NEOPLAN	67 68 84
				85 86
SETRA	93 94			
4311.20.00	MFZ430		IRISBUS	15
			RENAULT TRUCKS	88 90
4311.30.00	430W2GTZ	50X55-20Z	IRISBUS	15
			RENAULT TRUCKS	88 89 90
4312.30.00	430W2GTZ	1 3/4"-10Z	IRISBUS	15
			RENAULT TRUCKS	88 89 90
			SETRA	93
			YUTONG	105
4313.20.00	MFZ430		SCANIA	91 92
4313.26.00	MFZ430		SCANIA	91
43134.30.00	430WGTZ	2" -10N	MAN	31 43
			NEOPLAN	67 85 86
4314.30.00	430WGTZ	1 3/4"-10Z	MAN	33
			VAN HOOL	97

Arithmetical list

Reference	Parameter	Hub profile	Manufacturer	Page			
⊗ 4316.30.00	430WGTZ	1 3/4"-10Z	BMC (TÜRKİYE)	1			
			EVOBUS	4 8 9			
				10 11			
			GÜLERYÜZ (TÜRKİYE)	13			
			KAMAZ	21 127 129			
			LAZ	22			
			MAN	33 34 35			
				37 38 40			
				41 42			
				45			
⊗ 4319.20.00	MFZ430		MAN	32 45			
			NEOPLAN	67 68 69			
				83 84 85			
				86			
			⊗ 4322.30.00	430	1 3/4"-10N	VOLVO	99 100 101
						VOLVO	99 100 101
			⊗ 4323.30.00	430WGTZ	2" -10Z	VOLVO	99 101 104
			⊗ 4325.30.00	430WGTZ	46X50-24Z	VOLVO	99 100 102
							103 104 105
			⊗ 4326.30.00	430WGTZ	2"-10Z	IVECO	20
⊗ 4327.30.00	430GTZ	2"-10Z	IRISBUS	15			
			RENAULT TRUCKS	89 90			
⊗ 4328.20.00	MFZ430		SCANIA	91			
⊗ 4329.30.00	430WGTZ.	46x50-24Z	VOLVO	100 102 103			
				104 105			
⊗ 4329.60.00	⊕ MFZ430		MERCEDES-BENZ	49			
⊗ 4331.30.00	430WGTZ	2"-10Z	VOLVO	99 100 101			
				102 103 104			
⊗ 4331.60.00	⊕ MFZ430		SCANIA	91			
⊗ 4332.30.00	430GTZ	2"-10N	KAMAZ	21 22 127			
				129 130			
			MERCEDES-BENZ	58			
⊗ 4332.60.00	⊕ MFZ430		VOLVO	99 100 101			
				102 103 104			
				105			
⊗ 4333.30.00	430WGTZ	46X50-24Z	SCANIA	91 92			
⊗ 4333.60.00	⊕ MFZ430		VOLVO	99			
⊗ 4334.30.00	430GTZ	2"-10Z	MAN	31 32 33			
				42 43 44			
⊗ 4335.30.00	430GTZ	1 3/4"-10Z	KAMAZ	21 130			
⊗ 4335.60.00	⊕ MFZ430		IRISBUS	15			
			RENAULT TRUCKS	89 90			
⊗ 4336.60.00	⊕ MFZ430		RENAULT TRUCKS	90			
			VOLVO	100 102 103			
				104 105			
⊗ 4337.60.00	MFZ430		VOLVO	99 100 101			
⊗ 4339.20.00	MFZ430		MAN	31 33			
			NEOPLAN	83 84			
⊗ 4341.20.00	MFZ430		BOVA	2			
			EVOBUS	5			

Arithmetical list

Reference	Parameter	Hub profile	Manufacturer	Page		
⊗ 4346.30.00	430WGTZ	2" -10N	EOBUS	10	11	
			IRISBUS	15		
			MAN	30	31	35
				37	40	42
				43	45	
			MERCEDES-BENZ	49	53	56
				57	58	59
				61	62	66
			NEOPLAN	67	68	69
				83	84	85
	86					
	RENAULT TRUCKS	90				
	SETRA	93	94			
⊗ 43460.30.00	430WGTZ	2" -10N	EOBUS	10	11	
			MAN	30	31	
			MERCEDES-BENZ	56	57	62
			NEOPLAN	69	76	77
				78	79	80
	84	85	86			
⊗ 43461.30.00	430WGTZ	2" -10N	MAN	32	42	43
				44		
			MERCEDES-BENZ	57	61	
			NEOPLAN	84	85	86
	SETRA	93	94			
⊗ 4347.30.00	430WGTZ	2" -10N	MERCEDES-BENZ	61		
			NEOPLAN	67		
⊗ 4348.30.00	430WGTZ	2" -10N	SETRA	93	94	
⊗ 4356.30.00	430WGTZ	1 3/4"-10N	MAN	34	35	
			NEOPLAN	68		
⊗ 4386.20.00	MFZ430		NEOPLAN	68	82	83
⊗ 4386.30.00	430WGTZ	2"-10N	MAN	31	33	
			NEOPLAN	68	82	83
				84	85	
⊗ 4398.30.00	430WGTZ	46x50-24N	VOLVO	104	105	
⊗ 4500.40.00	KZIZ - 3		IVECO	18		
⊗ 4502.40.00	KZI - 1		IVECO	18		
⊗ 5700.40.00	KZIZ - 3		IKARUS	14		
			MERCEDES-BENZ	47	62	63
⊗ 5800.40.00	KZA - 2		IVECO	16	17	19
				115		
			ZASTAVA	105		
⊗ 5901.40.00	KZA - 4		VOLVO	98	99	101
				103		
⊗ 5902.40.00	KZA - 4		VOLVO	99	101	103
⊗ 6200.40.00	KZ - 4		ZASTAVA	106		
⊗ 6301.40.00	KZI - 2		IVECO	18	19	57
⊗ 6606.40.00	KFL - 555		TAM	94	95	
⊗ 6901.40.00	KZI - 3		MERCEDES-BENZ	50	54	55
				57	62	63
				64		
			NEOPLAN	68	82	
⊗ 6905.40.00	KZIS - 3		IVECO	19	20	
			MAGIRUS-DEUTZ	22	23	24
				25	28	29
				133	138	
			MAN	30	34	36
				38	39	40
			NEOPLAN	73		

Arithmetical list

Reference	Parameter	Hub profile	Manufacturer	Page		
⊙ 6907.40.00	KZI - 3		TAM	95	96	
⊙ 6908.40.00	KZ - 3		MERCEDES-BENZ	50 62	54 63	55
⊙ 6909.40.00	KZI - 3		MERCEDES-BENZ	50 62 65	54 63	55 64
⊙ 6915.40.00	KZI - 4		MERCEDES-BENZ	50	51	65
⊙ 7451.40.00	KZIS-4		IVECO	19		
			KAMAZ	21	127	
⊙ 7802.40.00	KZA - 4		VOLVO	99	103	
⊙ 7903.40.00	KZI-4		IVECO	16	17	116
⊙ 7906.40.00	KZA-4		VOLVO	98		
⊙ 7951.40.00	KZIS - 4		BOVA	2		
			EVOBUS	4 11	5	6
			IVECO	18	86	123
			MAGIRUS-DEUTZ	25 138 145	26 139	27 142 146
			MAN	35 38	36	37
⊙ 8401.40.00	KZI - 4,5		TAM	95		
⊙ 8500.40.00	KZI - 4,5		BOVA	2		
			DRÖGMÖLLER	3		
			MERCEDES-BENZ	51 54	52 59	53
			NEOPLAN	70 74 77 80	71 75 78	72 76 79
			TAM	81 95		
⊙ 8502.40.00	KZI - 4		MERCEDES-BENZ	55		
			SETRA	93		
⊙ 8505.40.00	KZI - 4,5		BOVA	2		
			MAGIRUS-DEUTZ	23 133	27	28
			MAN	37 44	38	40
			SCANIA	92		
			VAN HOOL	97	98	
⊙ 8509.40.00	KZI - 4,5		MERCEDES-BENZ	51		
⊙ 8510.40.00	KZI - 4,5		IVECO	20		
⊙ 8511.40.00	KZI - 4,5		MERCEDES-BENZ	51 59 66	52 60	53 65
			TAM	95		
⊙ 8512.40.00	KZI - 4,5		IVECO	20		

Arithmetical list

Reference	Parameter	Hub profile	Manufacturer	Page
⊙ 8514.40.00	KZI - 4,5		BOVA	2
			DAF	2 3
			EVOBUS	6
			IKARUS	14
			IVECO	18 60 62
				65 67 68
				69 70 71
				88 89 90
				91 92 93
				94 95 116
				117 118 119
				120 121 122
				123 124 125
			MAGIRUS-DEUTZ	22 24 25
				26 27 28
				29 138 142
				143 144 145
	146 147 148			
	SCANIA	92		
	VAN HOOL	96 97 98		
⊙ 8515.40.00	KZI - 4,5		NEOPLAN	67 69
⊙ 8520.40.00	KZI - 4,5		DRÖGMÖLLER	3
			EVOBUS	9
⊙ 8525.40.00	KZIS-3		RENAULT TRUCKS	89
⊙ 8529.40.00	KZI - 4,5		MERCEDES-BENZ	64 65
⊙ 8531.40.00	KZI - 4,5		IVECO	20
⊙ 8532.40.00	KZI - 4,5		IVECO	19 20
⊙ 8533.40.00	KZI - 4,5		KAMAZ	21 22 127
				130
⊙ 8536.40.00	KZIS-4		MERCEDES-BENZ	63 64
⊙ 8540.40.00	KZIS-4		MERCEDES-BENZ	47 60 62
⊙ 8631.47.00	HHISZ-4		SCANIA	91
⊙ 8641.47.00	PHIS-6/38		VOLVO	100 102 104
				105
⊙ 8900.40.00	KZI - 5		VOLVO	103
⊙ 8905.40.00	KZIZ - 5		EVOBUS	8
			MERCEDES-BENZ	56 57 61
				66
			SETRA	93
			VAN HOOL	98
⊙ 8916.40.00	KZIZ - 5		BOVA	1
			KAMAZ	21 22 127
				129 130
			MAN	30 31 32
				33 34 35
				37 38 40
				41 42 43
				44 45
			MAN (TÜRKİYE)	45
			NEOPLAN	67 68 84
				85 86
			TAM	95
			TEMSA (TÜRKİYE)	96
			VAN HOOL	98
			⊙ 8917.40.00	KZIZ - 5
	58 66			
⊙ 8918.40.00	KZISZ - 5		MERCEDES-BENZ	49

Arithmetical list

Reference	Parameter	Hub profile	Manufacturer	Page
8919.40.00	KZISZ - 5		IRISBUS	15
			IVECO	19 20
			MAN	31 32 33
				45
			NEOPLAN	67 68 69
				80 83 84
			85 86	
			SETRA	93
8923.40.00	KZIZ - 5		SCANIA	91
8925.40.00	KZISZ-5		VOLVO	99 100 101
				102
8928.40.00	KZIZ - 5		EVOBUS	10
			MERCEDES (TÜRKİYE)	46
			MERCEDES-BENZ	51 53 56
				57 58 59
				61 66
			SETRA	93
8934.40.00	KZISZ - 5		SCANIA	91
8935.40.00	KZISZ - 5		BMC (TÜRKİYE)	1
			BOVA	1
			EVOBUS	4 9 10
				11
			GÜLERYÜZ (TÜRKİYE)	13
			KAMAZ	21 130
			LAZ	22
			MAN	33
			MAZ	45
			MERCEDES-BENZ	57 58 59
				61
			NEOPLAN	66 67 68
				69 70 71
				72 73 74
				75 76 77
				78 79 80
				82 83
RENAULT TRUCKS	88 89 90			
			TEMSA	96
8936.40.00	KZISZ - 5		IRISBUS	15
			RENAULT TRUCKS	90
8937.40.00	KZISZ-5		IRISBUS	15
			RENAULT TRUCKS	88 90
8939.40.00	KZISZ - 5		EVOBUS	11
			IVECO	19
			KAMAZ	21
			MAN	31 33 45
			MERCEDES-BENZ	57 61 62
			NEOPLAN	67 68 69
				82 83 84
				85 86
				93 94
8944.40.00	KZIZ-5		MERCEDES-BENZ	57 61 62
			NEOPLAN	67 84 85
			SETRA	93 94
8946.46.00	KZIZ-5		VOLVO	99 100 101
				102
8951.40.00	KZISZ-5		MERCEDES-BENZ	49
9101.40.00	KZI - 5		BOVA	1

Cross reference list

OEM reference	RUEN reference	Parameter
---------------	----------------	-----------

ASKAM CHRYSLER (TÜRKİYE)

27900	3868.20.00	15" GM380
27901	3884.30.00	15" 380GSZ

AUWARTER

0401.424.41	4278.30.00	420W2GSZ
040114800	4255.30.00	420GS
040117500	8515.40.00	KZI - 4,5
0421.010.00	4244.20.00	GFX420KR
04210100099	4244.20.00	GFX420KR
11009966	4244.20.00	GFX420KR
11009994	4278.30.00	420W2GSZ
20280	4278.30.00	420W2GSZ
20295	4244.20.00	GFX420KR

BMC (TÜRKİYE)

52RS011979	4304.20.00	MFZ430
52RS015966	4304.20.00	MFZ430
52RS020390	43460.30.00	430WGTZ
57RS308621	3574.20.00	14" MF 350
D02967	8935.40.00	KZISZ - 5
D040463	3574.20.00	14" MF 350
D060053	3868.20.00	15" GM380
D060113	4300.20.00	MFZ430
D060281	4316.30.00	430WGTZ
HB8104YR	3884.30.00	15" 380GSZ

BOVA

239354	43460.30.00	430WGTZ
267748	43460.30.00	430WGTZ

CITROËN

95 632 809	2185.20.00	CP215
------------	------------	-------

DACIA

11 00 004 720	2045.30.00	200D
11 00 014 731	2045.30.00	200D

DAF

0291 228	4256.20.00	GMF420K
0376 491	3878.20.00	GMF380
096 006	4208.30.00	420GS
1140537	43460.30.00	430WGTZ
117 379	4244.30.00	420/210GSZ
117 380	4255.30.00	420GS
117 405	4248.20.00	GFX420KR
117 8753	4226.20.00	GF420KR
1204205	4303.20.00	MFZ430
1230549	4256.20.00	GMF420K
1239659	4300.30.00	430GTZ
1250710	8916.40.00	KZIZ - 5
1272115	4300.30.00	430GTZ
1287597	4300.30.00	430GTZ
1303975	8916.40.00	KZIZ - 5
1329549	4303.20.00	MFZ430
1362752	8916.40.00	KZIZ - 5
1375597	3953.20.00	MF395
1393177	43100.20.00	MFZ430E
1393177R	43100.20.00	MFZ430E
1458592	43100.20.00	MFZ430E
1458592R	43100.20.00	MFZ430E
161 852	4205.20.00	G420KR

OEM reference	RUEN reference	Parameter
---------------	----------------	-----------

161 854	3829.20.00	GF380KR
1625968	4300.90.03	
165 495	4208.30.00	420GS
165 499	4209.30.00	420GS
1663216	43100.20.00	MFZ430E
1663220	43134.30.00	430WGTZ
1664346	8916.40.00	KZIZ - 5
1685711	43134.30.00	430WGTZ
1686642	8939.40.00	KZISZ - 5
1697725	8939.40.00	KZISZ - 5
1700508R	3953.20.00	MF395
1703740	3953.20.00	MF395
1703740R	3953.20.00	MF395
1746150	8939.40.00	KZISZ - 5
1780332	8916.40.00	KZIZ - 5
1810168	8916.40.00	KZIZ - 5
1818190R	3953.20.00	MF395
1822487	8939.40.00	KZISZ - 5
1829974R	8939.40.00	KZISZ - 5
1830316	8939.40.00	KZISZ - 5
1843938R	3953.20.00	MF395
1846414	43134.30.00	430WGTZ
1846414R	43134.30.00	430WGTZ
1912687	8939.40.00	KZISZ - 5
1912689	8916.40.00	KZIZ - 5
1935399R	8939.40.00	KZISZ - 5
252 683	3564.30.00	350GSZ
286 877	3573.20.00	MF350
331 815	3563.30.00	350GSZ
504039135	3953.20.00	MF395
616 542	3852.30.00	380GS
740 784	4244.30.00	420/210GSZ
740 802	4255.30.00	420GS
ATR563	3953.20.00	MF395

DAF (TÜRKİYE)

0376491	3878.20.00	GMF380
0740784	4244.30.00	420/210GSZ
1329549	4303.20.00	MFZ430
1348144	3563.30.00	350GSZ
1362752	8916.40.00	KZIZ - 5
138933	4334.30.00	430GTZ

EICHER

175 522.M91	2802.20.00	G280
3141 909.M1	3300.20.00	GFM330
707 652	2518.20.00	G250
707 829	3131.20.00	G310

EOBUS

0.072.505.004	43100.20.00	MFZ430E
023 250 73 03	4348.30.00	430WGTZ
025 250 79 03	4348.30.00	430WGTZ
8.383.219.000	4253.20.00	GFX420KR
8.383.244.000	4253.20.00	GFX420KR
A 023 250 73 03	4348.30.00	430WGTZ
A 025 250 79 03	4348.30.00	430WGTZ

FIAT

4 456 2120 EB	2353.20.00	MFZ235
---------------	------------	--------

FORD

1475 197	2403.20.00	MF240
1518 419	2403.20.00	MF240

Cross reference list

OEM reference	RUEN reference	Parameter
FORD >>		
5 010 155	2150.90.10	
5 011 070	2150.90.10	
5 013 615	2150.90.10	
5 050 664	2150.90.10	
6055 852	2171.20.00	MF215K
6076 152	2172.30.00	215D
6107851	2171.20.00	MF215K
6107852	2171.20.00	MF215K
83BB 7563 CA	2171.20.00	MF215K
83BB 7563 DA	2171.20.00	MF215K
85BB 7563 AA	2171.20.00	MF215K

FORD (TÜRKİYE)		
AM93CT7563AA	3574.20.00	14" MF 350

HYUNDAI		
41200-8D000	43100.20.00	MFZ430E

IKARUS		
082.14.1045-005	4222.20.00	GF420KR
1299 393 670	8500.40.00	KZI - 4,5

IMR-BEOGRAD		
800 196	2802.20.00	G280
815 643	2802.20.00	G280
823 599	3503.20.00	G350KR

IMT-BEOGRAD-MASSEY FERGUSON		
514 00 260	4201.20.00	G420KR

INDOS		
8751-52-01.30	2802.20.00	G280

IVECO		
0126 6638	3552.30.00	350
0190 4749	2350.90.01	
0190 4797	2350.90.01	
0190 8520	2350.90.01	
0190 8552	2350.90.01	
0190 8555	2350.90.01	
01903832	3328.30.00	330WGSZ
01903841	2651.20.00	MF265
01903841	2655.30.00	265TB
01903890	3328.30.00	330WGSZ
01903907	2654.20.00	MF270
01903907	2656.30.00	270CTB
01903914	2650.90.01	
01904704	3328.30.00	330WGSZ
01904705	3328.30.00	330WGSZ
01904710	2654.20.00	MF270
01904710	2656.30.00	270CTB
01904718	2650.90.01	
01904760	2650.90.15	
01904771	3328.30.00	330WGSZ
01904772	3328.30.00	330WGSZ
01904795	2650.90.01	
01904798	2650.90.15	
01908521	2650.90.01	
01908523	2650.90.15	
01908543	2800.90.31	
01908544	2650.90.15	

OEM reference	RUEN reference	Parameter
01908545	2654.20.00	MF270
01908545	2656.30.00	270CTB
01908553	2800.90.31	
01908574	2650.90.15	
0244 23 06	3899.30.00	380GSZ
0244 23 07	3899.30.00	380GSZ
0244 2557	3812.30.00	380GSZ
0244 3805	2819.30.00	280GSZ
0247 6483	4250.20.00	GFX420KR
0247 9048	8514.40.00	KZI - 4,5
0247 9856	2955.20.00	GF295
0445 9822	4277.20.00	GFX420KR
0460 7799	2514.30.00	250CBL
0469 2717	4277.20.00	GFX420KR
0472 4694	8512.40.00	KZI - 4,5
0475 7082	8510.40.00	KZI - 4,5
0476 6075	3816.30.00	380GSZ
0478 7649	3169.20.00	MF310
0478 7652	3169.20.00	MF310
0483 9133	3816.30.00	380GSZ
049 99 161	4265.30.00	420GSZ
0855 8284	2810.30.00	280CBL
0856 6183	2514.30.00	250CBL
0857 8611	2810.30.00	280CBL
0858 2397	2810.30.00	280CBL
0858 8630	2810.30.00	280CBL
08586808	2656.30.00	270CTB
08586809	2654.20.00	MF270
08587332	2656.30.00	270CTB
08597015	2656.30.00	270CTB
08598464	2656.30.00	270CTB
127 8622	3804.20.00	G380KR
1447 9854	2955.20.00	GF295
244 2308	3810.20.00	G380KR
244 2557	3812.30.00	380GSZ
244 2558	3812.30.00	380GSZ
244 2563	3810.20.00	G380KR
244 2596	3861.30.00	380W2GSZ
244 3712	3805.30.00	380WGSZ
244 3713	3805.30.00	380WGSZ
244 3714	3805.30.00	380WGSZ
244 3844	3861.30.00	380W2GSZ
2443797KZ	3512.30.00	350W2GSZ
247 5334	4236.30.00	420/210GSZ
247 7181	4236.30.00	420/210GSZ
247 7896A	4236.30.00	420/210GSZ
247 7898	3804.20.00	G380KR
247 7898	3805.30.00	380WGSZ
247 7930	3812.30.00	380GSZ
2477935	3503.30.00	350GSZ
296 0741	3861.30.00	380W2GSZ
2991656	2650.90.15	
2992012	2650.90.15	
2992026	2800.90.31	
2992215	2800.90.31	
2992474	2350.90.01	
2992556	2650.90.15	
2992580	2800.90.31	
2992630	2800.90.31	
2992631	2650.90.15	
2994017	2350.90.01	
2994018	2650.90.15	
2994020	2800.90.31	
2994026	2650.90.15	

Cross reference list

OEM reference	RUEN reference	Parameter
IVECO >>		
2994027	2800.90.31	
2994034	2650.90.15	
2994036	2800.90.31	
2994037	2650.90.15	
2994040	2650.90.01	
2994069	2350.90.01	
2995559	2800.90.31	
2995704	2650.90.15	
2995705	2800.90.31	
2995706	2650.90.15	
2995776	2800.90.31	
2996089	2800.90.31	
4200 3325	3805.30.00	380WGSZ
4200 3473	8514.40.00	KZI - 4,5
4200 3474	8514.40.00	KZI - 4,5
4200 3736	3804.20.00	G380KR
4201 4240	4298.20.00	GF420
4201 4394	4237.20.00	GF420KR
4202 6780	4278.20.00	GFX420KR
4203 7237	3570.20.00	GMF350
4203 7967	3166.20.00	MF310
4206 1357	3585.30.00	350GSZ
4206 3184	8514.40.00	KZI - 4,5
42061411	3328.30.00	330WGSZ
4210 0567KZ	4268.30.00	420GSZ
4210 2097	4301.20.00	MFZ430
4210 2099	4301.20.00	MFZ430
4210 2148	3140.30.00	310W2GSZ
4210 2161	3805.30.00	380WGSZ
42102151	3328.30.00	330WGSZ
42102151/U-E	3328.30.00	330WGSZ
42102151/V-E	3328.30.00	330WGSZ
42102151/V-S	3328.30.00	330WGSZ
42102156	3512.30.00	350W2GSZ
42104709	3328.30.00	330WGSZ
445 9152	4226.20.00	GF420KR
460 5181	5800.40.00	KZA - 2
469 9160	4236.20.00	GF420KR
472 4654	8512.40.00	KZI - 4,5
4739151	4265.30.00	420GSZ
504029031	43460.30.00	430WGTZ
504039135	7451.40.00	KZIS-4
504059764	2350.90.01	
504061486	2350.90.01	
504080319	2350.90.01	
504122591	2800.90.31	
504213753	8514.40.00	KZI - 4,5
504229179	8514.40.00	KZI - 4,5
504229188	8514.40.00	KZI - 4,5
51.07-52-01.04	2518.20.00	G250
5107-52-01-03	2518.30.00	250GSZ
70704 0185	2514.20.00	H250K
7704 0185	2514.30.00	250CBL
7709 7510	2810.30.00	280CBL
8602 1252	3162.20.00	MF310
8602 1253	3162.20.00	MF310
8751-52-12.20	3131.20.00	G310
9380 1198	2402.30.00	240PSD
93801297	2651.20.00	MF265
93801299	2655.30.00	265TB
93808507	2655.30.00	265TB
93808508	2651.20.00	MF265

OEM reference	RUEN reference	Parameter
93808930	2651.20.00	MF265
93809013	2651.20.00	MF265
93811556	2655.30.00	265TB
93812451	2658.20.00	MFZ265
93812507	2678.30.00	265VTP
93812508	2658.20.00	MFZ265
98448583	2678.30.00	265VTP
98471641	2650.90.15	
98471692	2678.30.00	265VTP
99473296	2658.20.00	MFZ265

IVECO-FIAT (TÜRKİYE)

019038887	4268.30.00	420GSZ
01904730	4327.30.00	430GTZ
01904751	4301.20.00	MFZ430
01904785	8919.40.00	KZISZ - 5
01908524	4326.30.00	430WGTZ

JOHN DEERE

AZ 36712	3300.20.00	GFM330
----------	------------	--------

KAELBLE

59 286	3552.30.00	350
--------	------------	-----

KLOCKNER-HUMBOLDT-DEUTZ (KOLN)

0127 8622	3804.20.00	G380KR
1-1116-300-570.10	2802.20.00	G280

LIAZ

4421-7050-570.9	3860.20.00	GM380K
-----------------	------------	--------

LIEBHERR

5031-18808	4386.20.00	MFZ430
------------	------------	--------

MAGIRUS-DEUTZ

01260500	3505.20.00	G350KR
01260638	3505.20.00	G350KR
01261333	3804.20.00	G380KR
01262431	3804.20.00	G380KR
01266503	3505.20.00	G350KR
01266566	3804.20.00	G380KR
0127 2047 /U-E	3505.20.00	G350KR
01271852	3807.20.00	G380KR
01271976	3807.20.00	G380KR
01272035	3505.20.00	G350KR
01272040	3505.20.00	G350KR
01272042	3505.20.00	G350KR
01272047	3505.20.00	G350KR
01272048	3505.20.00	G350KR
01278622	3804.20.00	G380KR
01903816	3895.20.00	G380KR
01903848	3505.20.00	G350KR
01903849	3505.20.00	G350KR
01903850	3505.20.00	G350KR
01903873	3804.20.00	G380KR
01903874	3804.20.00	G380KR
01903875	3804.20.00	G380KR
01903876	3804.20.00	G380KR
01903877	3804.20.00	G380KR
01903878	3804.20.00	G380KR
01903879	4298.20.00	GF420
01903890	3300.20.00	GFM330
01903890	3328.30.00	330WGSZ

Cross reference list

OEM reference	RUEN reference	Parameter
MAGIRUS-DEUTZ >>		
01903925	3895.20.00	G380KR
01903946	3804.20.00	G380KR
01903948	3505.20.00	G350KR
01903950	3804.20.00	G380KR
01903950	3805.30.00	380WGSZ
01903952	3804.20.00	G380KR
01903952	3805.30.00	380WGSZ
01903955	3505.20.00	G350KR
01903956	3804.20.00	G380KR
01903957	4298.20.00	GF420
01904705	3300.20.00	GFM330
01904705	3328.30.00	330WGSZ
01904713	3804.20.00	G380KR
01904715	3804.20.00	G380KR
01904716	3804.20.00	G380KR
01904772	3300.20.00	GFM330
01904772	3328.30.00	330WGSZ
01904791	4298.20.00	GF420
02442309	3807.20.00	G380KR
02443712	3805.30.00	380WGSZ
02475546	6905.40.00	KZIS - 3
02475547	6905.40.00	KZIS - 3
02477898	3804.20.00	G380KR
02565803	6905.40.00	KZIS - 3
04626605	3804.20.00	G380KR
04695659	3804.20.00	G380KR
04695660	3804.20.00	G380KR
04733573	4298.20.00	GF420
42003033	3804.20.00	G380KR
42003325	3805.30.00	380WGSZ
42003396	6905.40.00	KZIS - 3
42003397	6905.40.00	KZIS - 3
42003734	3807.20.00	G380KR
42003736	3804.20.00	G380KR
42003737	3804.20.00	G380KR
42003852	4298.20.00	GF420
42016352	3300.20.00	GFM330
42026352	3300.20.00	GFM330
42026354	3300.20.00	GFM330
42026354/KZ	3300.20.00	GFM330
42061921	6905.40.00	KZIS - 3
42066352	3300.20.00	GFM330
42102161	3805.30.00	380WGSZ
42532403	4298.20.00	GF420
61146805	3505.20.00	G350KR
61146808	3804.20.00	G380KR
61751945	3804.20.00	G380KR
8739-47-13.10	3505.20.00	G350KR
8739-47-21.10	3804.20.00	G380KR
8751-52-51.36	3505.20.00	G350KR
8751-52-51.64	3505.20.00	G350KR
8751-52-51.65	3505.20.00	G350KR
8751-52-51.92	3804.20.00	G380KR

MAN		
30.30305.0048	4225.20.00	GF420KR
36.30550.0001	8919.40.00	KZISZ - 5
81.30000.6587	4301.20.00	MFZ430
81.30000.6587	4356.30.00	430WGTZ
81.30000.6587	8916.40.00	KZIZ - 5
81.30000.6600	4301.20.00	MFZ430
81.30000.6600	4356.30.00	430WGTZ

OEM reference	RUEN reference	Parameter
81.30000.6600	8916.40.00	KZIZ - 5
81.30000.6601	4301.20.00	MFZ430
81.30000.6602	4301.20.00	MFZ430
81.30000.6602	43460.30.00	430WGTZ
81.30000.6640	4300.90.183	
81.30005.9013	4300.90.05	
81.30005.9021	4300.90.05	
81.30005.9035	4300.90.184	
81.30301.0001	3610.30.00	362GTZ
81.30301.0059	3831.30.00	380GSZ
81.30301.0106	4283.30.00	420WGSZ
81.30301.0112	4250.30.00	420WGSZ
81.30301.0116	4249.30.00	420W2GSZ
81.30301.0128	3510.30.00	350W2GSZ
81.30301.0148	4250.30.00	420WGSZ
81.30301.0151	3870.30.00	380/210GSZ
81.30301.0228	3857.30.00	380W2GSZ
81.30301.0250	4281.30.00	420WGVZ
81.30301.0279	3587.30.00	350GSZ
81.30301.0284	38115.30.00	380GSZ
81.30301.0293	3510.30.00	350W2GSZ
81.30301.0299	4010.30.00	400WGVZ
81.30301.0300	4011.30.00	400GVZ
81.30301.0342	4249.30.00	420W2GSZ
81.30301.0350	3309.30.00	330GSZ
81.30301.0375	3596.30.00	350WGSZ
81.30301.0378	3951.30.00	395WGTZ
81.30301.0380	3309.30.00	330GSZ
81.30301.0393	3610.30.00	362GTZ
81.30301.0395	3610.30.00	362GTZ
81.30301.0416	4386.30.00	430WGTZ
81.30301.0438	4356.30.00	430WGTZ
81.30301.0440	43460.30.00	430WGTZ
81.30301.0448	4386.30.00	430WGTZ
81.30301.0449	3607.30.00	362WGTZ
81.30301.0456	4356.30.00	430WGTZ
81.30301.0457	4356.30.00	430WGTZ
81.30301.0470	3607.30.00	362WGTZ
81.30301.0475	3610.30.00	362GTZ
81.30301.0478	4386.30.00	430WGTZ
81.30301.0490	3607.30.00	362WGTZ
81.30301.0491	3607.30.00	362WGTZ
81.30301.0492	3607.30.00	362WGTZ
81.30301.0497	4356.30.00	430WGTZ
81.30301.0498	4356.30.00	430WGTZ
81.30301.0500	43460.30.00	430WGTZ
81.30301.0509	43460.30.00	430WGTZ
81.30301.0520	3607.30.00	362WGTZ
81.30301.0522	4386.30.00	430WGTZ
81.30301.0524	3951.30.00	395WGTZ
81.30301.0526	4386.30.00	430WGTZ
81.30301.0529	3607.30.00	362WGTZ
81.30301.0538	4386.30.00	430WGTZ
81.30301.0556	3607.30.00	362WGTZ
81.30301.0557	3951.30.00	395WGTZ
81.30301.0558	3951.30.00	395WGTZ
81.30301.0578	43461.30.00	430WGTZ
81.30301.0582	43460.30.00	430WGTZ
81.30301.0583	43460.30.00	430WGTZ
81.30301.0588	43461.30.00	430WGTZ
81.30301.0601	3951.30.00	395WGTZ
81.30301.0622	43461.30.00	430WGTZ
81.30301.0625	43460.30.00	430WGTZ
81.30301.0627	43461.30.00	430WGTZ

Cross reference list

OEM reference	RUEN reference	Parameter
MAN >>		
81.30301.0628	43461.30.00	430WGTZ
81.30301.0669	43461.30.00	430WGTZ
81.30301.6004	3831.30.00	380GSZ
81.30301.6005	3588.30.00	350GSZ
81.30301.6099	43461.30.00	430WGTZ
81.30301.9378	3951.30.00	395WGTZ
81.30301.9393	3610.30.00	362GTZ
81.30301.9438	4356.30.00	430WGTZ
81.30301.9457	4356.30.00	430WGTZ
81.30301.9473	4386.30.00	430WGTZ
81.30301.9492	3607.30.00	362WGTZ
81.30301.9557	3951.30.00	395WGTZ
81.30301.9575	4386.30.00	430WGTZ
81.30301.9627	43461.30.00	430WGTZ
81.30301.9669	43461.30.00	430WGTZ
81.30305.0006	3131.20.00	G310
81.30305.0046	3835.20.00	GF380
81.30305.0078	4224.20.00	GF420KR
81.30305.0079	3835.20.00	GF380
81.30305.0111	4235.20.00	GF420KR
81.30305.0113	4244.20.00	GFX420KR
81.30305.0113	4253.20.00	GFX420KR
81.30305.0117	4253.20.00	GFX420KR
81.30305.0124	4244.20.00	GFX420KR
81.30305.0137	4245.20.00	GFX420KR
81.30305.0138	4301.20.00	MFZ430
81.30305.0139	4301.20.00	MFZ430
81.30305.0158	4301.20.00	MFZ430
81.30305.0162	3573.20.00	MF350
81.30305.0165	4301.20.00	MFZ430
81.30305.0166	4300.20.00	MFZ430
81.30305.0179	4301.20.00	MFZ430
81.30305.0182	4301.20.00	MFZ430
81.30305.0184	3313.20.00	MFZ330
81.30305.0191	4301.20.00	MFZ430
81.30305.0193	4301.20.00	MFZ430
81.30305.0194	4301.20.00	MFZ430
81.30305.0201	3610.20.00	MFZ362
81.30305.0217	43100.20.00	MFZ430E
81.30305.0229	4386.20.00	MFZ430
81.30305.0237	43100.20.00	MFZ430E
81.30305.0239	4386.20.00	MFZ430
81.30305.0249	3855.30.00	380GS
81.30305.6007	2802.20.00	G280
81.30305.6020	4205.20.00	G420KR
81.30305.6024	4222.20.00	GF420KR
81.30305.6028	4224.20.00	GF420KR
81.30305.9113	4253.20.00	GFX420KR
81.30305.9191	4301.20.00	MFZ430
81.30305.9193	4301.20.00	MFZ430
81.30305.9194	4301.20.00	MFZ430
81.30305.9201	3610.20.00	MFZ362
81.30305.9219	4386.20.00	MFZ430
81.30305.9229	4386.20.00	MFZ430
81.30550.0041	8505.40.00	KZI - 4,5
81.30550.0050	8505.40.00	KZI - 4,5
81.30550.0096	8919.40.00	KZISZ - 5
81.30550.0101	8919.40.00	KZISZ - 5
81.30550.0102	8919.40.00	KZISZ - 5
81.30550.0103	8916.40.00	KZIZ - 5
81.30550.0109	8916.40.00	KZIZ - 5
81.30550.0110	8916.40.00	KZIZ - 5

OEM reference	RUEN reference	Parameter
81.30550.0114	8919.40.00	KZISZ - 5
81.30550.0116	8916.40.00	KZIZ - 5
81.30550.0118	8936.40.00	KZISZ - 5
81.30550.0118	8939.40.00	KZISZ - 5
81.30550.0249	8936.40.00	KZISZ - 5
81.30550.0249	8939.40.00	KZISZ - 5
81.30550.0251	8936.40.00	KZISZ - 5
81.30550.0251	8939.40.00	KZISZ - 5
81.30550.0255	8936.40.00	KZISZ - 5
81.30550.0255	8939.40.00	KZISZ - 5
81.30550.0264	8936.40.00	KZISZ - 5
81.30550.0264	8939.40.00	KZISZ - 5
81.30550.0270	8936.40.00	KZISZ - 5
81.30550.0270	8939.40.00	KZISZ - 5
81.32412.0006	8936.40.00	KZISZ - 5
81.32412.0006	8939.40.00	KZISZ - 5
8130301.0249	4250.30.00	420WGSZ
8130305.0166	4300.20.00	MFZ430
88.30301.0015	3831.30.00	380GSZ
88.30304.0003	3804.20.00	G380KR
88.30305.0002	3807.20.00	G380KR
88.30305.0003	3804.20.00	G380KR
88.30305.9003	3804.20.00	G380KR
90.44562.01	3804.20.00	G380KR
90.90445.6201	3804.20.00	G380KR

MAN (TÜRKİYE)

81.30301.0139	4036.30.00	400 WGTZ
81.30301.0228	38106.30.00	380WGTZ
81.30301.0247	3597.30.00	350 WGTZ
81.30301.0250	4281.30.00	420WGVZ
81.30301.0378	3951.30.00	395WGTZ
81.30301.0393	3610.30.00	362GTZ
81.30301.0492	3607.30.00	362WGTZ
81.30301.0505	4306.30.00	430WGTZ
81.30305.0124	4244.20.00	GFX420KR
81.30305.0193	4301.20.00	MFZ430
81.30305.0201	3610.20.00	MFZ362
81.30305.0220	4319.20.00	MFZ430
81.30401.7013	3505.20.00	G350KR
81.30550.0104	8919.40.00	KZISZ - 5
81.30550.0109	8916.40.00	KZIZ - 5

MANITOU

90395	2802.20.00	G280
-------	------------	------

MASSEY FERGUSON

945 522 M91	2802.20.00	G280
975 522 M91	2802.20.00	G280

MERCEDES (TÜRKİYE)

000 250 63 03	2528.30.00	250BHZX
001 250 00 04	3522.20.00	GF350KR
001 250 59 03	3104.30.00	310GSBL
001 250 75 04	2507.20.00	HBX250
001 250 97 03	3519.30.00	350GSZ
002 250 41 15	8918.40.00	KZISZ - 5
002 250 64 03	3831.30.00	380GSZ
002 250 96 04	3101.20.00	GFX310
003 250 22 04	3822.20.00	GF380KR
003 250 28 04	3821.20.00	GF380KR
003 250 48 04	3565.20.00	GMF350
003 250 61 04	4244.20.00	GFX420KR
003 250 70 04	4235.20.00	GF420KR

Cross reference list

OEM reference	RUEN reference	Parameter
MERCEDES (TÜRKİYE) >>		
003 250 99 04	3305.20.00	GMF330
004 250 24 04	3580.20.00	GMF350
004 250 89 04	4300.20.00	MFZ430
005 250 66 04	4329.60.00	MFZ430
005 250 84 04	4304.20.00	MFZ430
005 250 88 04	4010.10.00	MFZ2/400X
006 250 82 03	3325.30.00	330WGSZ
007 250 15 04	3951.20.00	MF395
008 250 08 03	3597.30.00	350 WGTZ
010 250 89 03	4021.30.00	400GVZ
010 250 92 03	4020.30.00	400GVZ
017 250 47 03	4306.30.00	430WGTZ
018 250 99 03	4306.30.00	430WGTZ
019 250 64 04	3606.20.00	MF362
019 250 97 03	3961.30.00	395GTZ

MERCEDES-BENZ		
000 250 38 15	8509.40.00	KZI - 4,5
000 250 40 15	6908.40.00	KZ - 3
000 250 41 04	3807.20.00	G380KR
000 250 42 15	6901.40.00	KZI - 3
000 250 46 04	2954.20.00	GF295
000 250 46 15	6901.40.00	KZI - 3
000 250 63 04	2953.20.00	GF295
000 250 70 15	8529.40.00	KZI - 4,5
000 250 74 15	8500.40.00	KZI - 4,5
000 250 75 15	8520.40.00	KZI - 4,5
000 250 76 15	8511.40.00	KZI - 4,5
000 250 77 15	8500.40.00	KZI - 4,5
000 250 78 15	6907.40.00	KZI - 3
000 250 82 03	2954.30.00	295BHZ
000 250 87 04	2812.20.00	HVB280
000 250 99 04	2507.20.00	HBX250
001 250 01 04	3521.20.00	GF350KR
001 250 03 04	3120.20.00	GFX310
001 250 16 04	3522.20.00	GF350KR
001 250 38 03	2954.30.00	295BHZ
001 250 40 03	2813.30.00	280BHZ
001 250 55 03	3822.30.00	380GSZ
001 250 67 03	3822.30.00	380GSZ
001 250 74 04	3522.20.00	GF350KR
001 250 75 04	2507.20.00	HBX250
001 250 79 15	8905.40.00	KZIZ - 5
001 250 85 04	4235.20.00	GF420KR
001 250 90 04	3122.20.00	GFX310
002 250 04 03	3104.30.00	310GSBL
002 250 31 04	3821.20.00	GF380KR
002 250 31 15	6908.40.00	KZ - 3
002 250 33 03	4231.30.00	420GSZ
002 250 34 03	3104.30.00	310GSBL
002 250 35 03	2528.30.00	250BHZX
002 250 36 03	2813.30.00	280BHZ
002 250 38 04	4235.20.00	GF420KR
002 250 61 04	3101.20.00	GFX310
002 250 63 15	8944.40.00	KZIZ-5
002 250 65 15	8540.40.00	KZIS-4
002 250 73 04	2283.20.00	M228KR
002 250 74 03	2528.30.00	250BHZX
002 250 75 04	3580.20.00	GMF350
002 250 83 15	8944.40.00	KZIZ-5
002 250 84 04	2845.20.00	HVB280
002 250 87 04	3300.20.00	GFM330

OEM reference	RUEN reference	Parameter
002 250 93 03	3892.30.00	380GSZ
002 250 94 04	3120.20.00	GFX310
002 250 96 04	3101.20.00	GFX310
002 250 97 03	3821.30.00	380GSZ
003 250 91 04	2282.20.00	M228KR
003 250 00 04	4235.20.00	GF420KR
003 250 10 04	2507.20.00	HBX250
003 250 11 04	2812.20.00	HVB280
003 250 12 04	2845.20.00	HVB280
003 250 14 04	3807.20.00	G380KR
003 250 14 15	8944.40.00	KZIZ-5
003 250 16 04	3522.20.00	GF350KR
003 250 22 04	3822.20.00	GF380KR
003 250 23 04	3525.20.00	GF350KR
003 250 25 04	3821.20.00	GF380KR
003 250 33 03	2954.30.00	295BHZ
003 250 33 04	4234.20.00	GF420KR
003 250 34 04	3521.20.00	GF350KR
003 250 37 04	2283.20.00	M228KR
003 250 41 04	4254.20.00	GF420X
003 250 48 04	3563.20.00	GMF350
003 250 48 15	8944.40.00	KZIZ-5
003 250 59 04	3300.20.00	GFM330
003 250 61 04	4253.20.00	GFX420KR
003 250 69 15	8944.40.00	KZIZ-5
003 250 70 04	4235.20.00	GF420KR
003 250 79 03	4257.30.00	420GSZ
003 250 82 03	3104.30.00	310GSBL
003 250 83 04	3857.20.00	G380KR
003 250 84 03	3300.30.00	330GSZ
003 250 84 04	3565.20.00	GMF350
003 250 86 03	3124.30.00	310GSBL
003 250 86 04	4253.20.00	GFX420KR
003 250 90 04	4253.20.00	GFX420KR
003 250 93 04	2837.20.00	MFZ280
003 250 94 04	3176.20.00	MFZ310
003 250 98 04	3164.20.00	MF310
003 250 99 04	3305.20.00	GMF330
004 250 00 04	4296.20.00	GF420
004 250 17 03	2281.30.00	228PSD
004 250 24 04	3580.20.00	GMF350
004 250 51 04	3176.20.00	MFZ310
004 250 54 04	3882.20.00	GF2/380
004 250 55 04KZ	3882.10.00	GF2/380
004 250 66 03	2813.30.00	280BHZ
004 250 71 04	3857.10.00	GF2/380
004 250 88 04	4305.20.00	MFZ430
004 250 90 03	3519.30.00	350GSZ
004 250 96 03	3892.30.00	380GSZ
004 250 98 04	3882.10.00	GF2/380
005 250 06 03	3104.30.00	310GSBL
005 250 10 03	2281.30.00	228PSD
005 250 11 04	3882.20.00	GF2/380
005 250 40 03	3583.30.00	350GSZ
005 250 64 04	4329.60.00	MFZ430
005 250 66 04	4329.60.00	MFZ430
005 250 83 04	4305.20.00	MFZ430
005 250 84 04	4304.20.00	MFZ430
005 250 86 03	3104.30.00	310GSBL
005 250 95 03	2822.30.00	280GTZ
005 259 49 03	3899.30.00	380GSZ
006 250 46 03	3897.30.00	380GSZ
006 250 82 03	3325.30.00	330WGSZ
006 250 87 03	4272.30.00	420WGSZ

Cross reference list

OEM reference	RUEN reference	Parameter
MERCEDES-BENZ >>		
006 250 95 03	3891.30.00	380GS
007 250 03 03	3889.30.00	380GSZ
007 250 09 03	3897.30.00	380GSZ
007 250 10 03	3897.30.00	380GSZ
007 250 12 03	4297.30.00	420GSZ
007 250 18 03	2813.30.00	280BHZ
007 250 19 03	2813.30.00	280BHZ
007 250 23 04	3952.20.00	MF395
007 250 24 04	3952.20.00	MF395
007 250 38 03	3822.30.00	380GSZ
007 250 40 04	43100.20.00	MFZ430E
007 250 43 03	4258.30.00	420GSZ
007 250 50 04	43100.20.00	MFZ430E
007 250 55 03	3888.30.00	380WGSZ
007 250 61 04	4329.60.00	MFZ430
007 250 62 04	43100.20.00	MFZ430E
007 250 74 03	3583.30.00	350GSZ
007 250 85 03	2306.30.00	228GSB
007 250 86 03	2306.30.00	228GSB
007 250 95 04	43100.20.00	MFZ430E
007 250 99 03	3136.30.00	310WGSZ
008 250 06 03	3325.30.00	330WGSZ
008 250 08 03	3517.30.00	350WGSZ
008 250 16 03	3855.30.00	380GS
008 250 24 04	4329.60.00	MFZ430
008 250 30 04	4329.60.00	MFZ430
008 250 46 03	3575.30.00	350WGSZ
008 250 72 03	3126.30.00	310GSBL
009 250 08 04	4329.60.00	MFZ430
009 250 13 03	3104.30.00	310GSBL
009 250 13 03	3124.30.00	310GSBL
009 250 13 03 KZ	3126.30.00	310GSBL
009 250 21 03	4305.30.00	430W2GTZ
009 250 26 03	2307.30.00	228CB
009 250 27 03	2307.30.00	228CB
009 250 30 03	2307.30.00	228CB
009 250 83 04	4329.60.00	MFZ430
010 250 07 04	4329.60.00	MFZ430
010 250 10 04	4329.60.00	MFZ430
010 250 26 03	2281.30.00	228PSD
010 250 77 03	3855.30.00	380GS
012 250 26 03	4272.30.00	420WGSZ
013 250 21 03	4305.30.00	430W2GTZ
013 250 57 03	3583.30.00	350GSZ
014 250 84 03	4347.30.00	430WGTZ
015 250 46 03	3961.30.00	395GTZ
015 250 63 03	3961.30.00	395GTZ
016 250 84 03	3961.30.00	395GTZ
018 250 92 03	3627.30.00	362WGTB
018 250 94 01	3620.90.02	
019 250 34 03	4347.30.00	430WGTZ
019 250 95 03	3961.30.00	395GTZ
019 250 99 03	3961.30.00	395GTZ
020 250 00 03	3961.30.00	395GTZ
020 250 58 03	43460.30.00	430WGTZ
021 250 25 01	3952.20.00	MF395
021 250 34 01	3620.90.02	
021 250 35 01	3620.90.02	
021 250 60 03	3627.30.00	362WGTB
021 250 61 03	3627.30.00	362WGTB
021 250 66 03	3961.30.00	395GTZ
021 250 67 03	3961.30.00	395GTZ

OEM reference	RUEN reference	Parameter
022 250 81 01	3606.20.00	MF362
022 250 87 03	3961.30.00	395GTZ
022 250 88 03	3961.30.00	395GTZ
024 250 17 03	3627.30.00	362WGTB
024 250 21 03	3627.30.00	362WGTB
025 250 23 01	3620.90.02	
025 250 25 01	3620.90.02	
305 250 06 15	6915.40.00	KZI - 4
317 250 02 04	3807.20.00	G380KR
327 250 11 15	6915.40.00	KZI - 4
340 250 02 15	6909.40.00	KZI - 3
352 250 01 15	6909.40.00	KZI - 3
352 250 05 15	6909.40.00	KZI - 3
381 250 04 15	6901.40.00	KZI - 3
695 250 70 04	3580.20.00	GMF350
695 250 71 03	3583.30.00	350GSZ
A 000 250 41 04	3807.20.00	G380KR
A 002 250 63 15	8944.40.00	KZIZ-5
A 002 250 65 15	8540.40.00	KZIS-4
A 002 250 83 15	8944.40.00	KZIZ-5
A 003 250 14 04	3807.20.00	G380KR
A 003 250 14 15	8944.40.00	KZIZ-5
A 003 250 48 15	8944.40.00	KZIZ-5
A 003 250 69 15	8944.40.00	KZIZ-5
A 005 250 64 04	4329.60.00	MFZ430
A 005 250 66 04	4329.60.00	MFZ430
A 007 250 23 04	3952.20.00	MF395
A 007 250 24 04	3952.20.00	MF395
A 007 250 40 04	43100.20.00	MFZ430E
A 007 250 50 04	43100.20.00	MFZ430E
A 007 250 61 04	4329.60.00	MFZ430
A 007 250 62 04	43100.20.00	MFZ430E
A 007 250 81 04	4329.60.00	MFZ430
A 007 250 95 04	43100.20.00	MFZ430E
A 008 250 24 04	4329.60.00	MFZ430
A 008 250 30 04	4329.60.00	MFZ430
A 009 250 08 04	4329.60.00	MFZ430
A 009 250 83 04	4329.60.00	MFZ430
A 010 250 07 04	4329.60.00	MFZ430
A 010 250 10 04	4329.60.00	MFZ430
A 014 250 84 03	4347.30.00	430WGTZ
A 015 250 46 03	3961.30.00	395GTZ
A 015 250 63 03	3961.30.00	395GTZ
A 016 250 84 03	3961.30.00	395GTZ
A 018 250 92 03	3627.30.00	362WGTB
A 018 250 94 01	3620.90.02	
A 018 250 94 03	43460.30.00	430WGTZ
A 019 250 34 03	4347.30.00	430WGTZ
A 019 250 66 03	43460.30.00	430WGTZ
A 019 250 95 03	3961.30.00	395GTZ
A 019 250 99 03	3961.30.00	395GTZ
A 020 250 00 03	3961.30.00	395GTZ
A 021 250 25 01	3952.20.00	MF395
A 021 250 34 01	3620.90.02	
A 021 250 35 01	3620.90.02	
A 021 250 60 03	3627.30.00	362WGTB
A 021 250 61 03	3627.30.00	362WGTB
A 021 250 66 03	3961.30.00	395GTZ
A 021 250 67 03	3961.30.00	395GTZ
A 022 250 81 01	3606.20.00	MF362
A 022 250 87 03	3961.30.00	395GTZ
A 022 250 88 03	3961.30.00	395GTZ
A 024 250 17 03	3627.30.00	362WGTB
A 024 250 21 03	3627.30.00	362WGTB

Cross reference list

OEM reference	RUEN reference	Parameter
---------------	----------------	-----------

MERCEDES-BENZ >>

A 025 250 23 01	3620.90.02	
A 025 250 25 01	3620.90.02	
A 317 250 02 04	3807.20.00	G380KR

NEOPLAN

0421.035.300	43460.30.00	430WGTZ
11010031	43460.30.00	430WGTZ

OTOKAR (TÜRKİYE)

13C0022005AC	3133.30.00	310GSBL
--------------	------------	---------

OTOYOL (TÜRKİYE)

30379	3133.30.00	310GSBL
45190	3188.20.00	MFZ 310
46613084	3169.20.00	MF310
52795	3133.30.00	310GSBL
60148673	3113.30.00	310GSBL
HA2526	2514.20.00	H250K

PEUGEOT

2001.92	2150.90.06	
2004 40	2185.20.00	CP215
2004.88	2150.90.06	
2054 52	2159.30.00	215CE
2054 93	2159.30.00	215CE
2055 14	2159.30.00	215CE

RENAULT

7700 587 482	2034.30.00	200CE
7700 722 064	2185.20.00	CP215
7700 743 120	2034.30.00	200CE
7700 743 123	2023.20.00	DB200
7700 850 865	2023.20.00	DB200

RENAULT (TÜRKİYE)

5000 677 197	6905.40.00	KZIS - 3
5010 244 023	3162.20.00	MF310
5010 244 202	8937.40.00	KZIS-5
5010 244 203	4311.20.00	MFZ430
5010 244 310	3574.20.00	14" MF 350
5010 245 447	4312.30.00	430W2GTZ
5010 245 448	4311.30.00	430W2GTZ
5010 452 822	8919.40.00	KZISZ - 5
5010 545 038	4306.30.00	430WGTZ
5010 545 852	4301.20.00	MFZ430

RENAULT TRUCKS

0001 151 857	3574.20.00	14" MF 350
0003 272 816	2525.20.00	MF250
0003 722 816	2525.20.00	MF250
23 618 037	3812.30.00	380GSZ
23 618 133	3866.20.00	GM380K
23 618 190	3866.20.00	GM380K
5000 0041 314	3562.20.00	GMF350
5000 055 186	2525.20.00	MF250
5000 055 986	2525.20.00	MF250
5000 059 526	4312.30.00	430W2GTZ
5000 240 959	3835.20.00	GF380
5000 249 083	3574.20.00	14" MF 350
5000 455 001	3563.20.00	GMF350
5000 534 738	3866.20.00	GM380K

OEM reference	RUEN reference	Parameter
---------------	----------------	-----------

5000 534 850	3562.20.00	GMF350
5000 534 850	3574.20.00	14" MF 350
5000 534 976	3570.30.00	350Z
5000 660 956	3574.20.00	14" MF 350
5000 667 054	4311.30.00	430W2GTZ
5000 677 154	4311.30.00	430W2GTZ
5000 677 243	4311.30.00	430W2GTZ
5000 677 249	4312.30.00	430W2GTZ
5000 677 328	4311.30.00	430W2GTZ
5000 788 292	4311.30.00	430W2GTZ
5000 788 573	3574.20.00	14" MF 350
5000 789 974	3574.20.00	14" MF 350
5000 789 975	3574.20.00	14" MF 350
5000 789 976	3574.20.00	14" MF 350
5000 826 290	2525.20.00	MF250
5000 826 314	3574.20.00	14" MF 350
5000 841 290	2525.20.00	MF250
5001 014 737	3574.20.00	14" MF 350
5001 811 639	2650.90.15	
5001 830 920	2525.20.00	MF250
5001 830 942	3500.90.42	
5001 845 014	3500.90.42	
5001 865 164	2650.90.15	
5001 865 764	3574.20.00	14" MF 350
5001 866 091	3500.90.42	
5001 867 502	2650.90.15	
5001 868 260	2650.90.15	
5001 868 273	3500.90.42	
5010 244 091	4312.30.00	430W2GTZ
5010 244 310	3574.20.00	14" MF 350
5010 245 267	2650.90.15	
5010 545 836	4386.20.00	MFZ430
5010 545 852	4313.20.00	MFZ430
5010 613 228	2650.90.15	
5010 639 242	2650.90.15	
5800 207 049	4250.30.00	420WGSZ
5800 207 052	4224.20.00	GF420KR
7420 811 639	2650.90.15	
7421 580 956	8641.47.00	PHIS-6/38
7421 580 968	8641.47.00	PHIS-6/38
7422 429 963	8641.47.00	PHIS-6/38
7485 003 687	8641.47.00	PHIS-6/38
7485 013 168	8641.47.00	PHIS-6/38
7485 020 473	8641.47.00	PHIS-6/38

SCANIA

1102425	4263.20.00	GMF420K
1111148	4333.30.00	430WGTZ
1113870	4313.20.00	MFZ430
1123296	8631.47.00	HHISZ-4
1321253	4333.30.00	430WGTZ
1321254	4313.20.00	MFZ430
1321258	4333.30.00	430WGTZ
1321259	4313.20.00	MFZ430
1324883	4333.30.00	430WGTZ
1335280	4060.60.00	MFZ400X
1335282	4052.30.00	400GVZ
1340192	4333.30.00	430WGTZ
1341687	4328.20.00	MFZ430
1349349	4051.30.00	400WGVZ
1355282	4052.30.00	400GVZ
1361679	4313.20.00	MFZ430
1365486	4313.20.00	MFZ430
1368697	4333.30.00	430WGTZ

Cross reference list

OEM reference	RUEN reference	Parameter
SCANIA >>		
1370793	4313.20.00	MFZ430
1370794	4313.20.00	MFZ430
1382331	4328.20.00	MFZ430
1386931	4333.30.00	430WGTZ
1390374	4051.30.00	400WGVZ
1393184	4060.60.00	MFZ400X
1393332	8631.47.00	HHISZ-4
1412319	4333.30.00	430WGTZ
1413177	4051.30.00	400WGVZ
1434649	8631.47.00	HHISZ-4
1444110	4333.30.00	430WGTZ
1479576	8934.40.00	KZISZ - 5
1499770	8934.40.00	KZISZ - 5
1510032	4333.30.00	430WGTZ
1513719	4313.20.00	MFZ430
1513720	4313.20.00	MFZ430
1522377	8631.47.00	HHISZ-4
1571220	4313.20.00	MFZ430
1728165	8934.40.00	KZISZ - 5
1749125	8934.40.00	KZISZ - 5
1851631	8934.40.00	KZISZ - 5
2164195	8934.40.00	KZISZ - 5
2274550	8934.40.00	KZISZ - 5
234 680	4261.20.00	GMF420K
234 682	4263.20.00	GMF420K
254 902	4201.20.00	G420KR
264 078	4235.30.00	420/210GS
304 398	4261.30.00	420GSZ
327 557	4263.20.00	GMF420K
327557	4263.20.00	GMF420K
327577	4263.20.00	GMF420K
329439	4263.20.00	GMF420K
382499	4313.20.00	MFZ430
382576	4313.20.00	MFZ430
550501	4000.90.60	
550502	4000.90.61	
571217	4313.20.00	MFZ430
571218	4313.20.00	MFZ430
571220	4313.20.00	MFZ430
571221	4313.20.00	MFZ430
571223	4052.30.00	400GVZ
571224	4051.30.00	400WGVZ
571226	4313.20.00	MFZ430
571227	4313.20.00	MFZ430
571268	4333.30.00	430WGTZ
571271	4333.30.00	430WGTZ
571289	4328.20.00	MFZ430
571291	4051.30.00	400WGVZ
571296	4051.30.00	400WGVZ
571300	4333.30.00	430WGTZ
571802	4000.90.60	
571803	4000.90.61	
572955	4300.90.09	
574983	4300.90.09	
6490375	4208.30.00	420GS

SCANIA (TÜRKİYE)

1102425	4263.20.00	GMF420K
1103482	4235.30.00	420/210GS
1104305	4261.20.00	GMF420K
1321259	4313.20.00	MFZ430
1324883	4333.30.00	430WGTZ

OEM reference	RUEN reference	Parameter
1341687	4328.20.00	MFZ430
1513720	4313.20.00	MFZ430
1728165	8934.40.00	KZISZ - 5
254902	4201.20.00	G420KR
394884	4263.20.00	GMF420K

STEYR

609 B16 0001	3131.20.00	G310
614160002	3506.20.00	G350
81500160011	4258.30.00	420GSZ
81560160006	4250.20.00	GFX420KR
99114160020	4257.30.00	420GSZ

TAM

0002-158	2803.30.00	280BHZ
205 1104	6606.40.00	KFL - 555
247 5800	8500.40.00	KZI - 4,5
502 40 64	3102.30.00	310GSZ
5179629	3503.30.00	350GSZ
5179637	3503.20.00	G350KR
5190118	3802.20.00	G380KR
5190126	3802.30.00	380GSZ
5243815	3103.20.00	GF310KR
525 3497	3857.30.00	380W2GSZ
533 6236	4250.30.00	420WGSZ
5409179	2821.30.00	280GTZ
55 992 16	6907.40.00	KZI - 3
5539630	2821.20.00	MF280K
5579 934	4253.20.00	GFX420KR
5582684	3166.20.00	MF310
5590 384	4268.30.00	420GSZ
5590 386	4236.20.00	GF420KR
5594 669	4235.20.00	GF420KR
5599 216	6907.40.00	KZI - 3
5601 007	3140.30.00	310W2GSZ
8751.52.51.36	3505.20.00	G350KR
8751-52-0130	2802.20.00	G280

TEMSA (TÜRKİYE)

81.30301.0492	3607.30.00	362WGTZ
81.30301.0505	4306.30.00	430WGTZ
81.30550.0109	8916.40.00	KZIZ - 5

VAN HOOL

100.901.513	4386.30.00	430WGTZ
10744609	43100.20.00	MFZ430E
10744649	43100.20.00	MFZ430E
109 96 028	43100.20.00	MFZ430E
10901513	4386.30.00	430WGTZ
11430376	4386.30.00	430WGTZ
518 312	4386.20.00	MFZ430

VOLVO

1526046	3528.30.00	350GSZ
1655164	3590.30.00	350GSZ
1655406	3511.10.00	GF2/350
1655407	3516.10.00	GF2/350
1655648	3528.30.00	350GSZ
1668 718	4203.20.00	G420KR
1668616	4305.20.00	MFZ430
20504343	4386.20.00	MFZ430
267 158	8900.40.00	KZI - 5
267 160	4211.20.00	G420KR
267 171	4257.20.00	GMF420K

Cross reference list

OEM reference	RUEN reference	Parameter
---------------	----------------	-----------

OEM reference	RUEN reference	Parameter
---------------	----------------	-----------

VOLVO

>>

267 248	3860.20.00	GM380K
267 417	4254.30.00	420GSZ
267142	3515.10.00	GF2/350
267249	3886.30.00	380GSZ
3018128	4254.30.00	420GSZ
3018130	3562.30.00	350GSZ
3192845	4054.30.00	400WGTZ
346 319	4203.20.00	G420KR
346 320	4254.30.00	420GSZ
348 842	8900.40.00	KZI - 5
355023	3886.30.00	380GSZ
355156	3562.30.00	350GSZ
8112754	4200.90.01	
85001033	4054.30.00	400WGTZ

VOLVO (TÜRKİYE)

1668372	3528.30.00	350GSZ
20569126	4332.60.00	MFZ430
267171	4257.20.00	GMF420K
3191766	4325.30.00	430WGTZ
3191991	4331.30.00	430WGTZ
3192201	4333.60.00	MFZ430
8113812	4300.90.33	

WARTBURG

353.0.08.501.1	1801.20.00	T180120
530.0.08.500.0	1801.30.00	180DE2R

ZASTAVA

08566184	2514.20.00	H250K
162 47 59	2514.30.00	250CBL
1624760	2514.20.00	H250K
4 661 18 92	2514.30.00	250CBL
466 12 145	2810.30.00	280CBL
466 13 085	3113.30.00	310GSBL
46612180	2810.20.00	H280K
46613084	3169.20.00	MF310
8584017	2810.20.00	H280K
859 90 98	3113.30.00	310GSBL

Comparison list by manufacturer

Comparison refer.	RUEN reference	Parameter
-------------------	----------------	-----------

BORG&BEG

HA 2526	2514.20.00	H250K
HB4522	2172.30.00	215D
HB8833	2159.30.00	215CE
HE4521	2171.20.00	MF215K
HE5475	2353.20.00	MFZ235

LUK

122 0026 12	2171.20.00	MF215K
125 0002 20	2507.20.00	HBX250
128 0011 50	2810.20.00	H280K
128 0219 20	2837.20.00	MFZ280
131 0030 20	3101.20.00	GFX310
131 0223 50	3169.20.00	MF310
133 0205 20	3305.20.00	GMF330
135 0201 20	3580.20.00	GMF350
142 0028 20	4235.20.00	GF420KR
320 0178 10	2034.30.00	200CE
322 0148 10	2172.30.00	215D
323 0062 16	2281.30.00	228PSD
323 0127 16	2307.30.00	228CB
325 0002 26	2528.30.00	250BHZX
328 0110 50	2810.30.00	280CBL
331 0001 26	3124.30.00	310GSBL
335 0002 26	3519.30.00	350GSZ
338 0003 26	3821.30.00	380GSZ
342 0011 26	4258.30.00	420GSZ
500 0008 20	6908.40.00	KZ - 3
500 0173 20	6901.40.00	KZI - 3

SACHS

1861 088 007	4203.30.00	420GS
3151 101 031	8514.40.00	KZI - 4,5
3482 000 187	3951.20.00	MF395
1862 390 031	4007.30.00	400WGTZ
1878 001 154	4249.30.00	420W2GSZ
1878 005 367	3512.30.00	350W2GSZ
1878 039 831	43460.30.00	430WGTZ
1878 047 333	3607.30.00	362WGTZ
1878 048 741	3627.30.00	362WGTB
1881 041 656	3807.20.00	G380KR
3151 169 031	8916.40.00	KZIZ - 5
3151 221 001	7451.40.00	KZIS-4
3400 700 304	4300.90.03	
3400 710 004	4300.90.09	
3482 123 832	3952.20.00	MF395
3482 124 001	3574.20.00	14" MF 350
3499 377 832	3562.20.00	GMF350
1800 107 133	4200.90.01	
1800 125 001	3500.90.51	
1800 125 201	2500.90.01	
1800 125 301	4200.90.17	
1800 125 601	4200.90.72	
1850 280 049	2402.20.00	MF240
1850 280 683	2810.20.00	H280K
1850 280 784	2514.20.00	H250K
1850 281 829	2810.30.00	280CBL
1850 281 917	2514.30.00	250CBL
1850 282 653	5800.40.00	KZA - 2
1850 480 049	2402.20.00	MF240
1850 480 076	2185.20.00	CP215
1850 481 008	2402.30.00	240PSD
1859 170 204	3515.50.00	GF2-350
1859 250 100	3882.50.00	GF2/380
1859 250 101	3857.50.00	GF2/380

Comparison refer.	RUEN reference	Parameter
-------------------	----------------	-----------

1859 250 102	3857.50.00	GF2/380
1860 062 037	2812.30.00	280Z
1861 034 003	3552.30.00	350
1861 034 047	3552.30.00	350
1861 034 147	3552.30.00	350
1861 060 003	2803.30.00	280BHZ
1861 206 111	4203.30.00	420GS
1861 206 112	4208.30.00	420GS
1861 206 113	4209.30.00	420GS
1861 206 211	4203.30.00	420GS
1861 206 212	4208.30.00	420GS
1861 206 242	4208.30.00	420GS
1861 219 009	3822.30.00	380GSZ
1861 219 111	3831.30.00	380GSZ
1861 219 141	3831.30.00	380GSZ
1861 219 157	3822.30.00	380GSZ
1861 219 179	3831.30.00	380GSZ
1861 224 033	2518.30.00	250GSZ
1861 224 034	2518.30.00	250GSZ
1861 224 048	2518.30.00	250GSZ
1861 234 001	3588.30.00	350GSZ
1861 234 010	3588.30.00	350GSZ
1861 244 101	2518.30.00	250GSZ
1861 254 034	2813.30.00	280BHZ
1861 254 037	2813.30.00	280BHZ
1861 279 031	2954.30.00	295BHZ
1861 279 133	2954.30.00	295BHZ
1861 279 135	2954.30.00	295BHZ
1861 288 105	3519.30.00	350GSZ
1861 288 135	3519.30.00	350GSZ
1861 288 136	3519.30.00	350GSZ
1861 291 033	2528.30.00	250BHZX
1861 291 036	2528.30.00	250BHZX
1861 291 136	2528.30.00	250BHZX
1861 296 033	2819.30.00	280GSZ
1861 296 034	2819.30.00	280GSZ
1861 303 202	3104.30.00	310GSBL
1861 303 232	3124.30.00	310GSBL
1861 303 243	3126.30.00	310GSBL
1861 303 246	3104.30.00	310GSBL
1861 303 246	3124.30.00	310GSBL
1861 303 248	3124.30.00	310GSBL
1861 303 248	3126.30.00	310GSBL
1861 321 139	3812.30.00	380GSZ
1861 325 105	3563.30.00	350GSZ
1861 325 106	3564.30.00	350GSZ
1861 325 135	3563.30.00	350GSZ
1861 325 141	3564.30.00	350GSZ
1861 325 142	3563.30.00	350GSZ
1861 329 139	3812.30.00	380GSZ
1861 350 201	3512.30.00	350W2GSZ
1861 350 231	3512.30.00	350W2GSZ
1861 350 233	3512.30.00	350W2GSZ
1861 351 305	3805.30.00	380WGSZ
1861 351 342	3805.30.00	380WGSZ
1861 409 105	4221.30.00	420 GSZ
1861 409 132	4203.30.00	420GS
1861 410 002	4231.30.00	420GSZ
1861 410 006	4258.30.00	420GSZ
1861 410 015	4257.30.00	420GSZ
1861 410 016	4258.30.00	420GSZ
1861 410 046	4258.30.00	420GSZ
1861 410 047	4231.30.00	420GSZ
1861 410 048	4257.30.00	420GSZ
1861 435 333	3861.30.00	380W2GSZ
1861 435 334	3861.30.00	380W2GSZ

Comparison list by manufacturer

Comparison refer.	RUEN reference	Parameter
SACHS >>		
1861 437 002	3559.30.00	350GSZ
1861 437 106	3562.30.00	350GSZ
1861 437 236	3562.30.00	350GSZ
1861 438 204	3516.30.00	350WGSZ
1861 438 234	3516.30.00	350WGSZ
1861 470 133	3899.30.00	380GSZ
1861 470 234	3831.30.00	380GSZ
1861 470 234	3899.30.00	380GSZ
1861 480 331	4283.30.00	420WGSZ
1861 480 335	4283.30.00	420WGSZ
1861 482 034	4255.30.00	420GS
1861 486 231	3857.30.00	380W2GSZ
1861 489 101	3870.30.00	380/210GSZ
1861 489 235	3510.30.00	350W2GSZ
1861 494 103	3821.30.00	380GSZ
1861 494 140	3821.30.00	380GSZ
1861 498 202	3510.30.00	350W2GSZ
1861 498 232	3510.30.00	350W2GSZ
1861 498 235	3510.30.00	350W2GSZ
1861 515 332	2281.30.00	228PSD
1861 521 231	4249.30.00	420W2GSZ
1861 521 234	4249.30.00	420W2GSZ
1861 526 003	4291.30.00	420GSZ
1861 526 014	4291.30.00	420GSZ
1861 527 002	4244.30.00	420/210GSZ
1861 527 033	4244.30.00	420/210GSZ
1861 535 001	3102.30.00	310GSZ
1861 557 103	2306.30.00	228GSB
1861 557 233	2306.30.00	228GSB
1861 557 235	2306.30.00	228GSB
1861 557 236	2306.30.00	228GSB
1861 557 237	2307.30.00	228CB
1861 560 204	4268.30.00	420GSZ
1861 560 234	4268.30.00	420GSZ
1861 569 031	4236.30.00	420/210GSZ
1861 569 038	4236.30.00	420/210GSZ
1861 571 101	3300.30.00	330GSZ
1861 571 110	3306.30.00	330GSZ
1861 571 131	3300.30.00	330GSZ
1861 571 236	3300.30.00	330GSZ
1861 572 431	4299.30.00	420GSZ
1861 577 037	3113.30.00	310GSBL
1861 577 136	3113.30.00	310GSBL
1861 579 131	3816.30.00	380GSZ
1861 598 103	4261.30.00	420GSZ
1861 598 133	4261.30.00	420GSZ
1861 599 102	3852.30.00	380GS
1861 600 033	3108.30.00	310GSZ
1861 620 233	2307.30.00	228CB
1861 620 234	2307.30.00	228CB
1861 632 032	2813.30.00	280BHZ
1861 632 032	2822.30.00	280GTZ
1861 635 031	3886.30.00	380GSZ
1861 635 035	3886.30.00	380GSZ
1861 639 004	4250.30.00	420WGSZ
1861 639 006	4250.30.00	420WGSZ
1861 639 031	4250.30.00	420WGSZ
1861 639 032	4250.30.00	420WGSZ
1861 639 035	4250.30.00	420WGSZ
1861 639 107	4250.30.00	420WGSZ
1861 639 148	4250.30.00	420WGSZ
1861 641 031	3528.30.00	350GSZ
1861 641 135	3528.30.00	350GSZ
1861 653 102	3140.30.00	310W2GSZ

Comparison refer.	RUEN reference	Parameter
1861 670 002	4261.30.00	420GSZ
1861 672 031	4254.30.00	420GSZ
1861 672 033	4254.30.00	420GSZ
1861 680 002	4261.30.00	420GSZ
1861 680 036	4261.30.00	420GSZ
1861 680 037	4261.30.00	420GSZ
1861 680 038	4235.30.00	420/210GS
1861 680 107	4261.30.00	420GSZ
1861 680 149	4261.30.00	420GSZ
1861 699 101	3892.30.00	380GSZ
1861 699 131	3892.30.00	380GSZ
1861 714 133	3575.30.00	350WGSZ
1861 715 032	4272.30.00	420WGSZ
1861 715 035	4272.30.00	420WGSZ
1861 724 003	4278.30.00	420W2GSZ
1861 724 104	4278.30.00	420W2GSZ
1861 724 137	4278.30.00	420W2GSZ
1861 742 032	3585.30.00	350GSZ
1861 760 034	4266.30.00	420/210GSZ
1861 775 035	2281.30.00	228PSD
1861 776 032	2159.30.00	215CE
1861 777 037	3563.30.00	350GSZ
1861 777 041	3563.30.00	350GSZ
1861 777 043	3564.30.00	350GSZ
1861 778 002	3328.30.00	330WGSZ
1861 778 003	3308.30.00	330GSZ
1861 778 003	3328.30.00	330WGSZ
1861 778 031	3328.30.00	330WGSZ
1861 787 004	3583.30.00	350GSZ
1861 787 031	3583.30.00	350GSZ
1861 787 034	3583.30.00	350GSZ
1861 856 132	2281.30.00	228PSD
1861 857 132	2172.30.00	215D
1861 860 131	4299.30.00	420GSZ
1861 861 031	3816.30.00	380GSZ
1861 861 032	3816.30.00	380GSZ
1861 863 233	3870.30.00	380/210GSZ
1861 866 032	3585.30.00	350GSZ
1861 869 042	2045.30.00	200D
1861 874 031	3328.30.00	330WGSZ
1861 874 032	3308.30.00	330GSZ
1861 874 032	3328.30.00	330WGSZ
1861 903 002	4291.30.00	420GSZ
1861 903 032	4291.30.00	420GSZ
1861 903 033	4291.30.00	420GSZ
1861 911 204	4282.30.00	420WGVZ
1861 911 232	4281.30.00	420WGVZ
1861 911 245	4281.30.00	420WGVZ
1861 911 303	4281.30.00	420WGVZ
1861 911 304	4282.30.00	420WGVZ
1861 912 034	3897.30.00	380GSZ
1861 912 035	3897.30.00	380GSZ
1861 919 031	2822.30.00	280GTZ
1861 919 032	2822.30.00	280GTZ
1861 919 033	2822.30.00	280GTZ
1861 919 034	2822.30.00	280GTZ
1861 919 134	2822.30.00	280GTZ
1861 923 002	3888.30.00	380WGSZ
1861 923 032	3888.30.00	380WGSZ
1861 936 031	2281.30.00	228PSD
1861 936 042	2281.30.00	228PSD
1861 936 142	2281.30.00	228PSD
1861 936 142	2306.30.00	228GSB
1861 941 032	4297.30.00	420GSZ
1861 941 033	4297.30.00	420GSZ
1861 957 231	3590.30.00	350GSZ

Comparison list by manufacturer

Comparison refer.	RUEN reference	Parameter
SACHS >>		
1861 961 033	3597.30.00	350 WGTZ
1861 962 033	3517.30.00	350WGSZ
1861 963 033	3325.30.00	330WGSZ
1861 964 034	3136.30.00	310WGSZ
1861 986 135	4244.30.00	420/210GSZ
1861 986 140	4259.30.00	420GSZ
1861 988 031	4335.30.00	430GTZ
1861 988 034	4335.30.00	430GTZ
1861 992 432	4327.30.00	430GTZ
1861 999 221	2821.30.00	280GTZ
1862 108 031	4346.30.00	430WGTZ
1862 108 034	4346.30.00	430WGTZ
1862 109 034	4346.30.00	430WGTZ
1862 122 031	3889.30.00	380GSZ
1862 122 131	3889.30.00	380GSZ
1862 122 132	3889.30.00	380GSZ
1862 122 134	3889.30.00	380GSZ
1862 123 131	3891.30.00	380GS
1862 135 003	3855.30.00	380GS
1862 135 035	3855.30.00	380GS
1862 188 032	4305.30.00	430W2GTZ
1862 190 105	4021.30.00	400GVZ
1862 193 105	4020.30.00	400GVZ
1862 211 031	4279.30.00	420WGSZ
1862 215 032	4305.30.00	430W2GTZ
1862 215 032	4347.30.00	430WGTZ
1862 216 032	4304.30.00	430WGTZ
1862 216 032	4312.30.00	430W2GTZ
1862 217 032	4346.30.00	430WGTZ
1862 217 033	4346.30.00	430WGTZ
1862 217 235	4346.30.00	430WGTZ
1862 217 335	4346.30.00	430WGTZ
1862 217 337	4346.30.00	430WGTZ
1862 226 131	4356.30.00	430WGTZ
1862 226 346	4356.30.00	430WGTZ
1862 226 511	4356.30.00	430WGTZ
1862 227 034	4281.30.00	420WGVZ
1862 235 001	38115.30.00	380GSZ
1862 236 031	3587.30.00	350GSZ
1862 283 133	4305.30.00	430W2GTZ
1862 299 032	3136.30.00	310WGSZ
1862 302 031	4011.30.00	400GVZ
1862 303 031	4010.30.00	400WGVZ
1862 308 031	3821.30.00	380GSZ
1862 315 101	4300.30.00	430GTZ
1862 326 032	4333.30.00	430WGTZ
1862 347 131	2413.30.00	240TD
1862 356 031	3888.30.00	380WGSZ
1862 364 133	4008.30.00	400 WGVZ
1862 374 003	4284.30.00	420WGSZ
1862 382 031	4054.30.00	400WGTZ
1862 418 031	4356.30.00	430WGTZ
1862 419 101	4346.30.00	430WGTZ
1862 438 031	3309.30.00	330GSZ
1862 438 032	3309.30.00	330GSZ
1862 441 031	43460.30.00	430WGTZ
1862 441 131	43460.30.00	430WGTZ
1862 450 031	4052.30.00	400GVZ
1862 454 031	4051.30.00	400WGVZ
1862 461 031	4333.30.00	430WGTZ
1862 461 132	4333.30.00	430WGTZ
1862 491 031	3596.30.00	350WGSZ
1862 494 031	4356.30.00	430WGTZ
1862 506 131	3951.30.00	395WGTZ

Comparison refer.	RUEN reference	Parameter
1862 519 137	4305.30.00	430W2GTZ
1862 519 243	4347.30.00	430WGTZ
1862 519 259	4305.30.00	430W2GTZ
1862 519 259	4347.30.00	430WGTZ
1862 528 032	3610.30.00	362GTZ
1862 530 231	4323.30.00	430WGTZ
1862 541 031	3610.30.00	362GTZ
1862 541 032	3610.30.00	362GTZ
1862 722 001	2810.30.00	280CBL
1862 768 001	1801.30.00	180DE2R
1862 811 001	2656.30.00	270CTB
1862 867 004	2034.30.00	200CE
1862 909 141	2178.30.00	215CE
1862 935 001	2178.30.00	215CE
1862 936 142	2281.30.00	228PSD
1862 954 142	2080.30.00	200VTB
1862 967 001	2655.30.00	265TB
1862 967 002	2514.30.00	250CBL
1862 977 001	2402.30.00	240PSD
1864 279 033	2954.30.00	295BHZ
1864 351 006	3570.30.00	350Z
1878 000 036	3952.30.00	395WGTZ
1878 000 055	4316.30.00	430WGTZ
1878 000 055	4356.30.00	430WGTZ
1878 000 104	3812.30.00	380GSZ
1878 000 104	3822.30.00	380GSZ
1878 000 105	3821.30.00	380GSZ
1878 000 105	3852.30.00	380GS
1878 000 105	3897.30.00	380GSZ
1878 000 116	4305.30.00	430W2GTZ
1878 000 205	4332.30.00	430GTZ
1878 000 206	4335.30.00	430GTZ
1878 000 294	3954.30.00	395WGTZ
1878 000 634	4325.30.00	430WGTZ
1878 000 841	3596.30.00	350WGSZ
1878 000 948	4329.30.00	430WGTZ.
1878 000 957	38115.30.00	380GSZ
1878 000 957	3816.30.00	380GSZ
1878 000 959	3816.30.00	380GSZ
1878 000 961	3886.30.00	380GSZ
1878 000 967	3870.30.00	380/210GSZ
1878 001 030	4346.30.00	430WGTZ
1878 001 070	3564.30.00	350GSZ
1878 001 070	3583.30.00	350GSZ
1878 001 071	3563.30.00	350GSZ
1878 001 074	3519.30.00	350GSZ
1878 001 074	3588.30.00	350GSZ
1878 001 077	3585.30.00	350GSZ
1878 001 077	3587.30.00	350GSZ
1878 001 078	3564.30.00	350GSZ
1878 001 083	3559.30.00	350GSZ
1878 001 136	4297.30.00	420GSZ
1878 001 138	4208.30.00	420GS
1878 001 144	3510.30.00	350W2GSZ
1878 001 144	3517.30.00	350WGSZ
1878 001 144	3597.30.00	350 WGTZ
1878 001 145	3596.30.00	350WGSZ
1878 001 147	3575.30.00	350WGSZ
1878 001 152	38106.30.00	380WGTZ
1878 001 152	3857.30.00	380W2GSZ
1878 001 154	4249.30.00	420W2GSZ
1878 001 155	4283.30.00	420WGSZ
1878 001 215	4325.30.00	430WGTZ
1878 001 496	4348.30.00	430WGTZ
1878 001 938	4386.30.00	430WGTZ
1878 002 072	2354.30.00	235CBL

Comparison list by manufacturer

Comparison refer.	RUEN reference	Parameter
SACHS >>		
1878 002 139	4386.30.00	430WGTZ
1878 002 504	4331.30.00	430WGTZ
1878 002 643	4036.30.00	400 WGTZ
1878 002 706	42130.30.00	420GTZ
1878 002 729	4305.30.00	430W2GTZ
1878 002 733	4331.30.00	430WGTZ
1878 002 791	4347.30.00	430WGTZ
1878 003 066	4333.30.00	430WGTZ
1878 003 238	4261.30.00	420GSZ
1878 003 276	4291.30.00	420GSZ
1878 003 647	4332.30.00	430GTZ
1878 003 657	4250.30.00	420WGSZ
1878 003 657	4272.30.00	420WGSZ
1878 003 779	4054.30.00	400WGTZ
1878 003 784	3961.30.00	395GTZ
1878 003 867	4329.30.00	430WGTZ.
1878 004 573	43134.30.00	430WGTZ
1878 004 832	4305.30.00	430W2GTZ
1878 004 832	4346.30.00	430WGTZ
1878 004 832	43461.30.00	430WGTZ
1878 005 367	3512.30.00	350W2GSZ
1878 005 367	3516.30.00	350WGSZ
1878 005 540	4348.30.00	430WGTZ
1878 005 541	43461.30.00	430WGTZ
1878 005 668	4304.30.00	430WGTZ
1878 005 805	4020.30.00	400GVZ
1878 006 584	4329.30.00	430WGTZ.
1878 007 046	4398.30.00	430WGTZ
1878 013 031	4051.30.00	400WGVZ
1878 013 132	4051.30.00	400WGVZ
1878 020 241	4311.30.00	430W2GTZ
1878 022 841	4305.30.00	430W2GTZ
1878 023 731	4346.30.00	430WGTZ
1878 023 831	3961.30.00	395GTZ
1878 026 241	4312.30.00	430W2GTZ
1878 031 002	4356.30.00	430WGTZ
1878 031 032	4356.30.00	430WGTZ
1878 031 048	4356.30.00	430WGTZ
1878 032 032	4007.30.00	400WGTZ
1878 037 001	4291.30.00	420GSZ
1878 037 441	2159.30.00	215CE
1878 037 631	4333.30.00	430WGTZ
1878 037 831	4356.30.00	430WGTZ
1878 037 834	4346.30.00	430WGTZ
1878 037 838	4346.30.00	430WGTZ
1878 037 844	43460.30.00	430WGTZ
1878 037 854	4356.30.00	430WGTZ
1878 037 857	43460.30.00	430WGTZ
1878 037 858	4347.30.00	430WGTZ
1878 038 041	4386.30.00	430WGTZ
1878 039 631	3962.30.00	395GTZ
1878 039 731	3113.30.00	310GSBL
1878 040 334	4322.30.00	430
1878 040 334	4322.30.00	430WGTZ
1878 040 631	4334.30.00	430GTZ
1878 043 231	4051.30.00	400WGVZ
1878 044 631	3610.30.00	362GTZ
1878 045 541	2172.30.00	215D
1878 046 631	3951.30.00	395WGTZ
1878 052 842	3627.30.00	362WGTB
1878 054 031	4331.30.00	430WGTZ
1878 054 933	4334.30.00	430GTZ
1878 054 951	4327.30.00	430GTZ
1878 054 953	4346.30.00	430WGTZ

Comparison refer.	RUEN reference	Parameter
1878 061 841	4314.30.00	430WGTZ
1878 063 231	4333.30.00	430WGTZ
1878 063 501	3575.30.00	350WGSZ
1878 063 501	3576.30.00	350WGSZ
1878 063 531	3607.30.00	362WGTZ
1878 065 131	4304.30.00	430WGTZ
1878 065 531	4347.30.00	430WGTZ
1878 074 641	2822.30.00	280GTZ
1878 074 741	2518.30.00	250GSZ
1878 076 031	3563.30.00	350GSZ
1878 079 331	3607.30.00	362WGTZ
1878 080 031	4316.30.00	430WGTZ
1878 080 031	4356.30.00	430WGTZ
1878 080 033	4306.30.00	430WGTZ
1878 080 034	4346.30.00	430WGTZ
1878 080 034	43460.30.00	430WGTZ
1878 080 035	4305.30.00	430W2GTZ
1878 080 035	4346.30.00	430WGTZ
1878 080 037	4346.30.00	430WGTZ
1878 080 037	4347.30.00	430WGTZ
1878 085 641	4300.30.00	430GTZ
1878 085 741	4326.30.00	430WGTZ
1878 086 741	4304.30.00	430WGTZ
1878 086 742	4259.30.00	420GSZ
1878 086 941	4282.30.00	420WGVZ
1878 237 831	4316.30.00	430WGTZ
1878 634 008	2178.30.00	215CE
1878 634 009	2178.30.00	215CE
1878 634 017	4236.30.00	420/210GSZ
1878 634 026	4331.30.00	430WGTZ
1878 634 027	4305.30.00	430W2GTZ
1878 634 052	2306.30.00	228GSB
1878 634 082	2528.30.00	250BHZX
1878 997 101	2678.30.00	265VTP
1880 019 445	3515.10.00	GF2/350
1880 083 102	2802.20.00	G280
1880 083 132	2802.20.00	G280
1880 092 405	3131.20.00	G310
1880 092 435	3131.20.00	G310
1881 010 139	2518.20.00	G250
1881 039 003	3505.20.00	G350KR
1881 039 531	3506.20.00	G350
1881 039 532	3505.20.00	G350KR
1881 039 539	3505.20.00	G350KR
1881 041 526	3807.20.00	G380KR
1881 041 556	3807.20.00	G380KR
1881 041 656	3807.20.00	G380KR
1882 039 532	3505.20.00	G350KR
1882 110 202	3521.20.00	GF350KR
1882 110 532	3521.20.00	GF350KR
1882 110 542	3521.20.00	GF350KR
1882 166 707	3822.20.00	GF380KR
1882 166 737	3822.20.00	GF380KR
1882 201 101	2954.20.00	GF295
1882 201 102	2953.20.00	GF295
1882 201 103	2955.20.00	GF295
1882 201 132	2953.20.00	GF295
1882 201 133	2955.20.00	GF295
1882 205 234	2507.20.00	HBX250
1882 209 334	3563.20.00	GMF350
1882 226 402	4203.20.00	G420KR
1882 226 433	4211.20.00	G420KR
1882 226 533	4203.20.00	G420KR
1882 230 232	2812.20.00	HVB280
1882 230 238	2812.20.00	HVB280
1882 234 403	3522.20.00	GF350KR

Comparison list by manufacturer

Comparison refer.	RUEN reference	Parameter
SACHS >>		
1882 234 433	3522.20.00	GF350KR
1882 252 301	3120.20.00	GFX310
1882 252 303	3122.20.00	GFX310
1882 252 331	3120.20.00	GFX310
1882 252 333	3122.20.00	GFX310
1882 301 208	4234.20.00	GF420KR
1882 301 209	4235.20.00	GF420KR
1882 301 237	4222.20.00	GF420KR
1882 301 238	4234.20.00	GF420KR
1882 301 239	4224.20.00	GF420KR
1882 301 239	4235.20.00	GF420KR
1882 301 239	4254.20.00	GF420X
1882 301 240	4296.20.00	GF420
1882 302 101	3821.20.00	GF380KR
1882 302 131	3821.20.00	GF380KR
1882 302 131	3835.20.00	GF380
1882 302 134	3835.20.00	GF380
1882 303 102	4250.20.00	GFX420KR
1882 303 103	4248.20.00	GFX420KR
1882 303 108	4254.20.00	GF420X
1882 303 141	4254.20.00	GF420X
1882 305 101	3101.20.00	GFX310
1882 305 131	3101.20.00	GFX310
1882 308 102	4201.20.00	G420KR
1882 308 103	4205.20.00	G420KR
1882 308 133	4205.20.00	G420KR
1882 311 101	3525.20.00	GF350KR
1882 316 005	4237.20.00	GF420KR
1882 316 033	4226.20.00	GF420KR
1882 316 038	4298.20.00	GF420
1882 317 101	2845.20.00	HVB280
1882 317 131	2845.20.00	HVB280
1882 325 032	3810.20.00	G380KR
1882 325 033	3802.20.00	G380KR
1882 325 034	3804.20.00	G380KR
1882 325 039	3895.20.00	G380KR
1882 325 134	3804.20.00	G380KR
1882 325 139	3895.20.00	G380KR
1882 326 001	4236.20.00	GF420KR
1882 326 331	4236.20.00	GF420KR
1882 327 001	3829.20.00	GF380KR
1882 330 002	4222.20.00	GF420KR
1882 330 031	4224.20.00	GF420KR
1882 330 032	4222.20.00	GF420KR
1882 330 033	4225.20.00	GF420KR
1882 331 033	3821.20.00	GF380KR
1882 331 033	3835.20.00	GF380
1882 335 233	4277.20.00	GFX420KR
1882 335 234	4278.20.00	GFX420KR
1882 335 236	4277.20.00	GFX420KR
1882 341 001	3857.20.00	G380KR
1882 342 105	4245.20.00	GFX420KR
1882 342 133	4253.20.00	GFX420KR
1882 342 134	4244.20.00	GFX420KR
1882 342 134	4253.20.00	GFX420KR
1882 349 001	3882.20.00	GF2/380
1882 349 002	3882.20.00	GF2/380
1882 349 003	3882.20.00	GF2/380
1882 600 122	2507.20.00	HBX250
1882 806 001	2809.20.00	H280
1882 814 001	2514.20.00	H250K
1882 815 001	2810.20.00	H280K
1888 019 344	3511.10.00	GF2/350
1888 019 445	3515.10.00	GF2/350

Comparison refer.	RUEN reference	Parameter
1888 019 539	3516.10.00	GF2/350
1888 019 542	3515.10.00	GF2/350
1888 042 009	3857.10.00	GF2/380
1888 055 005	3882.10.00	GF2/380
1888 055 035	3882.10.00	GF2/380
1888 055 041	3882.10.00	GF2/380
1891 986 135	4255.30.00	420GS
1898 917 329	3596.30.00	350WGSZ
3000 120 001	2150.90.10	
3000 152 002	2150.90.06	
3000 154 001	2000.90.19	
3000 169 002	2000.90.36	
3000 169 004	2000.90.40	
3000 290 001	2150.90.18	
3000 297 002	2280.90.03	
3000 322 001	1800.90.02	
3000 324 001	1800.90.02	
3000 325 001	1800.90.02	
3000 389 002	2400.90.04	
3000 389 004	2400.90.06	
3000 441 002	2150.90.07	
3000 463 001	2150.90.16	
3000 569 001	2150.90.42	
3000 826 901	2400.90.05	
3000 830 001	2350.90.01	
3000 830 201	2280.90.02	
3000 830 301	2280.90.04	
3000 951 249	2350.90.01	
3082 038 031	2171.20.00	MF215K
3082 054 132	2283.20.00	M228KR
3082 119 131	2185.20.00	CP215
3082 121 031	2282.20.00	M228KR
3082 121 031	2283.20.00	M228KR
3082 122 132	2403.20.00	MF240
3082 131 031	2171.20.00	MF215K
3082 133 041	2042.20.00	CP20
3082 156 031	2283.20.00	M228KR
3082 196 131	2403.20.00	MF240
3082 859 101	2023.20.00	DB200
3082 859 141	2023.20.00	DB200
3082 859 143	2023.20.00	DB200
3082 879 042	2171.20.00	MF215K
3082 899 001	2185.20.00	CP215
3082 966 001	1801.20.00	T180120
3082 967 001	1801.20.00	T180120
3083 039 031	2353.20.00	MFZ235
3100 002 255	8918.40.00	KZISZ - 5
3100 026 433	8946.46.00	KZIZ-5
3151 000 034	8916.40.00	KZIZ - 5
3151 000 144	8919.40.00	KZISZ - 5
3151 000 151	8934.40.00	KZISZ - 5
3151 000 155	8918.40.00	KZISZ - 5
3151 000 157	8935.40.00	KZISZ - 5
3151 000 163	8925.40.00	KZISZ-5
3151 000 206	3214.40.00	KZI/T - 1
3151 000 272	8923.40.00	KZIZ - 5
3151 000 335	8944.40.00	KZIZ-5
3151 000 374	8529.40.00	KZI - 4,5
3151 000 375	8500.40.00	KZI - 4,5
3151 000 395	7951.40.00	KZIS - 4
3151 000 395	8505.40.00	KZI - 4,5
3151 000 396	8540.40.00	KZIS-4
3151 000 419	7451.40.00	KZIS-4
3151 000 493	8936.40.00	KZISZ - 5
3151 000 493	8939.40.00	KZISZ - 5
3151 000 497	8951.40.00	KZISZ-5

Comparison list by manufacturer

Comparison refer.	RUEN reference	Parameter
SACHS >>		
3151 000 512	8514.40.00	KZI - 4,5
3151 000 515	8514.40.00	KZI - 4,5
3151 000 958	8533.40.00	KZI - 4,5
3151 007 301	8514.40.00	KZI - 4,5
3151 007 303	8514.40.00	KZI - 4,5
3151 027 131	8500.40.00	KZI - 4,5
3151 033 031	6908.40.00	KZ - 3
3151 034 031	3214.40.00	KZI/T - 1
3151 043 031	8509.40.00	KZI - 4,5
3151 044 031	6901.40.00	KZI - 3
3151 054 032	8532.40.00	KZI - 4,5
3151 058 001	8514.40.00	KZI - 4,5
3151 065 031	4502.40.00	KZI - 1
3151 066 002	8505.40.00	KZI - 4,5
3151 066 032	8505.40.00	KZI - 4,5
3151 067 031	8533.40.00	KZI - 4,5
3151 071 032	8510.40.00	KZI - 4,5
3151 087 041	8502.40.00	KZI - 4
3151 094 041	6915.40.00	KZI - 4
3151 095 043	6909.40.00	KZI - 3
3151 098 031	8531.40.00	KZI - 4,5
3151 105 041	8900.40.00	KZI - 5
3151 105 141	8900.40.00	KZI - 5
3151 108 031	8520.40.00	KZI - 4,5
3151 112 031	8529.40.00	KZI - 4,5
3151 114 031	8510.40.00	KZI - 4,5
3151 116 031	6907.40.00	KZI - 3
3151 119 001	8515.40.00	KZI - 4,5
3151 126 031	8511.40.00	KZI - 4,5
3151 127 031	8512.40.00	KZI - 4,5
3151 133 331	3214.40.00	KZI/T - 1
3151 152 102	7951.40.00	KZIS - 4
3151 157 001	8505.40.00	KZI - 4,5
3151 169 131	8916.40.00	KZIZ - 5
3151 169 332	8916.40.00	KZIZ - 5
3151 170 131	5700.40.00	KZIZ - 3
3151 182 233	9101.40.00	KZI - 5
3151 195 032	8935.40.00	KZISZ - 5
3151 195 033	8935.40.00	KZISZ - 5
3151 199 001	6905.40.00	KZIS - 3
3151 203 031	8919.40.00	KZISZ - 5
3151 213 031	4500.40.00	KZIZ - 3
3151 225 001	8919.40.00	KZISZ - 5
3151 225 031	8919.40.00	KZISZ - 5
3151 234 132	8936.40.00	KZISZ - 5
3151 245 031	8928.40.00	KZIZ - 5
3151 245 032	8917.40.00	KZIZ - 5
3151 246 031	8905.40.00	KZIZ - 5
3151 250 231	8937.40.00	KZISZ-5
3151 259 001	8918.40.00	KZISZ - 5
3151 259 031	8918.40.00	KZISZ - 5
3151 261 031	8540.40.00	KZIS-4
3151 272 631	8529.40.00	KZI - 4,5
3151 273 431	8916.40.00	KZIZ - 5
3151 273 731	8944.40.00	KZIZ-5
3151 275 601	3211.40.00	KZIS - 0
3151 600 529	4500.40.00	KZIZ - 3
3151 600 540	7903.40.00	KZI-4
3151 803 001	3206.40.00	KZIS - 1
3151 824 002	5902.40.00	KZA - 4
3151 824 003	5901.40.00	KZA - 4
3151 824 005	7802.40.00	KZA - 4
3151 838 001	3209.40.00	KZAS - 1
3151 843 001	3205.40.00	KZIS - 0

Comparison refer.	RUEN reference	Parameter
3151 846 001	3216.40.00	KZAS - 0
3151 847 001	3224.40.00	KZAS - 00
3151 859 001	3233.40.00	KZAS - 0B
3151 868 001	3212.40.00	KZI - 0
3151 999 116	6907.40.00	KZI - 3
3180 000 001	8918.40.00	KZISZ - 5
3182 006 131	8631.47.00	HHISZ-4
3182 006 231	8631.47.00	HHISZ-4
3182 006 531	8631.47.00	HHISZ-4
3182 009 936	8631.47.00	HHISZ-4
3182 009 938	8631.47.00	HHISZ-4
3400 037 031	3800.90.10	
3400 037 032	3800.90.48	
3400 042 031	4200.90.79	
3400 043 032	4300.90.33	
3400 106 031	4300.90.21	
3400 116 901	4300.90.47	
3400 117 202	4300.90.48	
3400 117 701	2650.90.15	
3400 119 001	4200.90.49	
3400 121 401	3620.90.01	
3400 121 801	3620.90.10	
3400 122 001	4300.90.09	
3400 122 101	4300.90.03	
3400 122 201	4300.90.05	
3400 122 301	4300.90.49	
3400 122 401	3100.90.12	
3400 122 601	4300.90.01	
3400 123 001	4300.90.18	
3400 123 401	4300.90.61	
3400 123 501	4000.90.61	
3400 123 601	4000.90.60	
3400 123 701	4300.90.11	
3400 124 001	4300.90.01	
3400 124 101	4300.90.30	
3400 124 301	3300.90.04	
3400 124 701	3800.90.52	
3400 125 001	3500.90.11	
3400 125 101	3500.90.11	
3400 125 501	3500.90.04	
3400 125 601	4200.90.72	
3400 125 701	4200.90.77	
3400 125 901	4200.90.84	
3400 127 101	4300.90.34	
3400 127 201	4300.90.21	
3400 127 701	3620.90.02	
3400 127 801	4300.90.58	
3400 128 001	4300.90.59	
3400 700 305	4200.90.22	
3400 700 322	3300.90.08	
3400 700 329	4300.90.75	
3400 700 330	4300.90.54	
3400 700 339	3500.90.42	
3400 700 342	4300.90.16	
3400 700 344	4300.90.65	
3400 700 345	4300.90.44	
3400 700 347	3100.90.13	
3400 700 349	4300.90.400	
3400 700 350	4300.90.62	
3400 700 354	4300.90.51	
3400 700 381	4300.90.56	
3400 700 403	4300.90.13	
3400 700 404	4300.90.12	
3400 700 409	4300.90.60	
3400 700 429	2650.90.01	
3400 700 432	2800.90.31	

Comparison list by manufacturer

Comparison refer.	RUEN reference	Parameter
SACHS >>		
3400 700 433	2350.90.01	
3400 700 444	2650.90.15	
3400 700 445	4300.90.77	
3400 700 447	2650.90.15	
3400 700 450	4300.90.56	
3400 700 451	4300.90.57	
3400 700 459	4300.90.105	
3400 700 505	4300.90.182	
3400 700 506	4300.90.183	
3400 700 507	4300.90.184	
3400 700 509	4300.90.180	
3400 700 510	4300.90.185	
3400 700 643	4300.90.405	
3482 000 042	43100.20.00	MFZ430E
3482 000 151	4313.20.00	MFZ430
3482 000 195	4339.20.00	MFZ430
3482 000 196	4319.20.00	MFZ430
3482 000 197	3952.20.00	MF395
3482 000 246	4339.20.00	MFZ430
3482 000 251	4313.20.00	MFZ430
3482 000 361	4319.20.00	MFZ430
3482 000 461	3608.20.00	MF362
3482 000 462	3606.20.00	MF362
3482 000 463	3951.20.00	MF395
3482 000 464	3952.20.00	MF395
3482 000 474	3953.20.00	MF395
3482 000 573	4303.20.00	MFZ430
3482 000 852	4307.20.00	MFZ430
3482 000 953	3580.20.00	GMF350
3482 001 101	4261.20.00	GMF420K
3482 001 104	4263.20.00	GMF420K
3482 001 134	4263.20.00	GMF420K
3482 001 139	4261.20.00	GMF420K
3482 001 234	4263.20.00	GMF420K
3482 002 102	3563.20.00	GMF350
3482 002 103	3562.20.00	GMF350
3482 002 104	3563.20.00	GMF350
3482 002 107	3565.20.00	GMF350
3482 002 132	3563.20.00	GMF350
3482 002 135	3563.20.00	GMF350
3482 002 137	3563.20.00	GMF350
3482 002 202	3563.20.00	GMF350
3482 002 203	3562.20.00	GMF350
3482 002 204	3563.20.00	GMF350
3482 002 204	3565.20.00	GMF350
3482 002 232	3563.20.00	GMF350
3482 002 233	3562.20.00	GMF350
3482 002 234	3563.20.00	GMF350
3482 002 235	3563.20.00	GMF350
3482 002 237	3563.20.00	GMF350
3482 002 237	3565.20.00	GMF350
3482 006 032	4291.20.00	GTF420
3482 006 036	4291.20.00	GTF420
3482 008 003	3162.20.00	MF310
3482 008 006	3166.20.00	MF310
3482 008 008	3164.20.00	MF310
3482 008 033	3162.20.00	MF310
3482 008 033	3169.20.00	MF310
3482 008 038	3164.20.00	MF310
3482 011 201	3580.20.00	GMF350
3482 011 331	3580.20.00	GMF350
3482 012 201	3300.20.00	GFM330
3482 012 211	3300.20.00	GFM330
3482 012 231	3300.20.00	GFM330

Comparison refer.	RUEN reference	Parameter
3482 012 237	3300.20.00	GFM330
3482 012 240	3304.20.00	GMF330
3482 012 240	3305.20.00	GMF330
3482 017 034	3878.20.00	GMF380
3482 018 101	4257.20.00	GMF420K
3482 018 132	4256.20.00	GMF420K
3482 018 202	4256.20.00	GMF420K
3482 018 205	4256.20.00	GMF420K
3482 018 231	4257.20.00	GMF420K
3482 021 001	3860.20.00	GM380K
3482 021 031	3860.20.00	GM380K
3482 037 041	3866.20.00	GM380K
3482 037 141	3866.20.00	GM380K
3482 038 001	3570.20.00	GMF350
3482 051 131	3580.20.00	GMF350
3482 051 201	3580.20.00	GMF350
3482 054 031	2837.20.00	MFZ280
3482 054 131	2837.20.00	MFZ280
3482 055 102	3176.20.00	MFZ310
3482 055 132	3176.20.00	MFZ310
3482 060 131	3573.20.00	MF350
3482 060 132	3573.20.00	MF350
3482 060 233	3573.20.00	MF350
3482 081 231	4304.20.00	MFZ430
3482 081 232	4305.20.00	MFZ430
3482 081 233	4300.20.00	MFZ430
3482 081 233	4307.20.00	MFZ430
3482 083 031	4300.20.00	MFZ430
3482 083 032	4301.20.00	MFZ430
3482 083 032	4303.20.00	MFZ430
3482 083 034	4311.20.00	MFZ430
3482 083 034	4313.20.00	MFZ430
3482 083 039	4313.20.00	MFZ430
3482 083 039	4313.26.00	MFZ430
3482 083 041	4303.20.00	MFZ430
3482 083 113	4300.20.00	MFZ430
3482 083 118	4304.20.00	MFZ430
3482 083 119	4301.20.00	MFZ430
3482 083 150	4328.20.00	MFZ430
3482 085 033	4236.20.00	GF420KR
3482 093 032	3313.20.00	MFZ330
3482 118 031	4248.20.00	GFX420KR
3482 119 031	4256.20.00	GMF420K
3482 119 032	4257.20.00	GMF420K
3482 119 034	4263.20.00	GMF420K
3482 120 031	3610.20.00	MFZ362
3482 123 234	4304.26.00	MFZ430
3482 123 235	4304.26.00	MFZ430
3482 123 534	4339.20.00	MFZ430
3482 123 833	3951.20.00	MF395
3482 123 839	3953.20.00	MF395
3482 124 041	3573.20.00	MF350
3482 124 041	3574.20.00	14" MF 350
3482 124 514	4261.20.00	GMF420K
3482 124 516	4253.20.00	GFX420KR
3482 124 522	4250.20.00	GFX420KR
3482 124 531	4237.20.00	GF420KR
3482 124 532	4298.20.00	GF420
3482 124 534	42110.20.00	GMF430
3482 124 534	4224.20.00	GF420KR
3482 124 534	4225.20.00	GF420KR
3482 124 541	4226.20.00	GF420KR
3482 124 541	4234.20.00	GF420KR
3482 124 542	4264.20.00	GFM420K
3482 124 549	42111.20.00	GMF430
3482 125 131	4278.20.00	GFX420KR

Comparison list by manufacturer

Comparison refer.	RUEN reference	Parameter
SACHS >>		
3482 125 512	3608.20.00	MF362
3482 126 331	3606.20.00	MF362
3482 906 001	3169.20.00	MF310
3482 907 001	2651.20.00	MF265
3482 911 001	2654.20.00	MF270
3482 998 701	2658.20.00	MFZ265
3482 999 027	2821.20.00	MF280K
3483 020 036	4331.60.00	MFZ430
3483 028 031	4060.60.00	MFZ400X
3483 030 032	4329.60.00	MFZ430
3483 034 032	4332.60.00	MFZ430
3483 034 033	4332.60.00	MFZ430
3483 034 034	4333.60.00	MFZ430
3483 034 042	4336.60.00	MFZ430
3483 034 045	4337.60.00	MFZ430
3488 017 333	4001.10.00	MFZ2/400X
3488 017 432	4010.10.00	MFZ2/400X
3499 373 055	2525.20.00	MF250
6482 000 087	8641.47.00	PHIS-6/38
6482 000 155	8641.47.00	PHIS-6/38

VALEO		
003 398	2150.90.18	
003 446	2150.90.06	
079 800	2023.20.00	DB200
094 185	4263.20.00	GMF420K
094 492	2023.20.00	DB200
178 622 TUR.	3188.20.00	MFZ 310
261 673	2514.20.00	H250K
263 105	2042.20.00	CP20
263 645	3866.20.00	GM380K
264 630	3211.40.00	KZIS - 0
264 635	2171.20.00	MF215K
265 315	3216.40.00	KZAS - 0
265 529	2159.30.00	215CE
266 121	3224.40.00	KZAS - 00
266 244	2159.30.00	215CE
266 923	2185.20.00	CP215
267 426	2185.20.00	CP215
275 853	3209.40.00	KZAS - 1
279 014	3866.20.00	GM380K
279 118	2402.20.00	MF240
279 165	2023.20.00	DB200
279 375	2402.30.00	240PSD
279 379	2034.30.00	200CE
279 389	2403.20.00	MF240
279 421	2023.20.00	DB200
279 431	4502.40.00	KZI - 1
279 458	2042.20.00	CP20
355 100	4211.20.00	G420KR
355 101	4254.30.00	420GSZ
355 102	4201.20.00	G420KR
355 104	3521.20.00	GF350KR
355 106	3522.20.00	GF350KR
355 108	3522.20.00	GF350KR
355 111	3804.20.00	G380KR
355 119	4205.20.00	G420KR
355 125	2507.20.00	HBX250
355 128	3519.30.00	350GSZ
355 130	3822.30.00	380GSZ
355 131	2953.20.00	GF295
355 132	2954.30.00	295BHZ
355 138	4235.20.00	GF420KR
355 139	4231.30.00	420GSZ

Comparison refer.	RUEN reference	Parameter
355 140	3120.20.00	GFX310
355 141	4222.20.00	GF420KR
355 146	3822.20.00	GF380KR
355 149	4226.20.00	GF420KR
355 150	4248.20.00	GFX420KR
355 153	4244.30.00	420/210GSZ
355 164	3510.30.00	350W2GSZ
355 165	3821.20.00	GF380KR
355 176	3528.30.00	350GSZ
355 178	4257.20.00	GMF420K
355 338	3126.30.00	310GSBL
355 575	2172.30.00	215D
355 576	2172.30.00	215D
355 591	3214.40.00	KZI/T - 1
357 810	3812.30.00	380GSZ
357 978	2812.20.00	HVB280
358 192	3563.20.00	GMF350
358 200	2403.20.00	MF240
358 262	2282.20.00	M228KR
358 262	2283.20.00	M228KR
358 275	3206.40.00	KZIS - 1
358 279	2307.30.00	228CB
358 280	3565.20.00	GMF350
358 281	8509.40.00	KZI - 4,5
358 282	3562.20.00	GMF350
358 286	8500.40.00	KZI - 4,5
358 295	3300.20.00	GFM330
358 296	3300.30.00	330GSZ
358 297	6901.40.00	KZI - 3
358 320	2171.20.00	MF215K
358 323	8900.40.00	KZI - 5
358 331	3829.20.00	GF380KR
358 332	3878.20.00	GMF380
358 333	3852.30.00	380GS
358 335	4261.20.00	GMF420K
358 336	3525.20.00	GF350KR
358 338	3104.30.00	310GSBL
358 350	4244.20.00	GFX420KR
358 511	8514.40.00	KZI - 4,5
358 546	6908.40.00	KZ - 3
358 547	6908.40.00	KZ - 3
358 810	3812.30.00	380GSZ
472 020	2810.20.00	H280K
508 028	4304.20.00	MFZ430
582 472	3580.20.00	GMF350
583 314	3133.30.00	310GSBL
583 314 TUR.	3133.30.00	310GSBL
583 584	3174.20.00	MF310
801 040	2150.90.10	
801 250	2150.90.07	
801 409	2350.90.01	
801 435	2280.90.02	
801 546	2280.90.03	
801 881	2400.90.04	
801 939	1800.90.02	
802 308	1801.20.00	T180120
802 321	2023.20.00	DB200
803 393	1801.30.00	180DE2R
804 007	3233.40.00	KZAS - 0B
804 019	3214.40.00	KZI/T - 1
804 022	3205.40.00	KZIS - 0
804 106	3212.40.00	KZI - 0
805 028	4300.90.01	
805 062	4300.90.05	
805 073	4300.90.11	
805 164	4300.90.03	

Comparison list by manufacturer

Comparison refer.	RUEN reference	Parameter
VALEO >>		
805 172	3516.10.00	GF2/350
805 175	3857.10.00	GF2/380
805 176	3882.10.00	GF2/380
805 186	4300.90.05	
805 450	4300.90.09	
805 453	4300.90.11	
805 454	4300.90.09	
805 508	3574.20.00	14" MF 350
805 513	4305.20.00	MFZ430
805 525	3164.20.00	MF310
805 531	2353.20.00	MFZ235
805 549	4222.20.00	GF420KR
805 549	4234.20.00	GF420KR
805 564	3305.20.00	GMF330
805 566	3580.20.00	GMF350
805 600	4301.20.00	MFZ430
805 601	3882.20.00	GF2/380
805 602	2282.20.00	M228KR
805 607	3162.20.00	MF310
805 632	4313.20.00	MFZ430
805 633	4307.20.00	MFZ430
805 642	4300.20.00	MFZ430
805 643	3860.20.00	GM380K
805 645	3101.20.00	GF310
805 646	3807.20.00	G380KR
805 649	4224.20.00	GF420KR
805 691	3122.20.00	GF310
805 707	2802.20.00	G280
805 708	3857.20.00	G380KR
805 711	4304.20.00	MFZ430
805 724	4301.20.00	MFZ430
805 726	4263.20.00	GMF420K
805 748	3804.20.00	G380KR
805 750	2518.20.00	G250
805 752	3131.20.00	G310
805 779	3606.20.00	MF362
805 781	4329.60.00	MFZ430
805 785	4311.20.00	MFZ430
805 786	4328.20.00	MFZ430
805 787	4328.20.00	MFZ430
805 798	4332.60.00	MFZ430
805 801	4332.60.00	MFZ430
805 809	4236.20.00	GF420KR
805 831	4305.20.00	MFZ430
805 842	3951.20.00	MF395
806 012	4258.30.00	420GSZ
806 013	3570.30.00	350Z
806 015	4305.30.00	430W2GTZ
806 018	3583.30.00	350GSZ
806 019	2528.30.00	250BHZX
806 021	3821.30.00	380GSZ
806 024	4311.30.00	430W2GTZ
806 092	2810.30.00	280CBL
806 097	2813.30.00	280BHZ
806 113	2822.30.00	280GTZ
806 117	3136.30.00	310WGSZ
806 128	3309.30.00	330GSZ
806 137	2514.30.00	250CBL
806 179	4272.30.00	420WGSZ
806 183	2306.30.00	228GSB
806 190	4305.30.00	430W2GTZ
806 200	4327.30.00	430GTZ
806 315	3892.30.00	380GSZ
806 363	4250.30.00	420WGSZ

Comparison refer.	RUEN reference	Parameter
806 432	3325.30.00	330WGSZ
806 441	4326.30.00	430WGTZ
806 443	4327.30.00	430GTZ
806 449	4306.30.00	430WGTZ
806 450	3517.30.00	350WGSZ
806 476	4203.30.00	420GS
806 478	4257.30.00	420GSZ
806 504	6905.40.00	KZIS - 3
806 507	4500.40.00	KZIZ - 3
806 508	8919.40.00	KZISZ - 5
806 529	8520.40.00	KZI - 4,5
806 532	8511.40.00	KZI - 4,5
806 611	8905.40.00	KZIZ - 5
806 615	8505.40.00	KZI - 4,5
806 616	8916.40.00	KZIZ - 5
806 662	8401.40.00	KZI - 4,5
806 675	8937.40.00	KZISZ-5
806 677	8918.40.00	KZISZ - 5
807 503	4334.30.00	430GTZ
807 507	4306.30.00	430WGTZ
807 508	4312.30.00	430W2GTZ
807 518	4261.30.00	420GSZ
807 540	2528.30.00	250BHZX
807 542	4235.30.00	420/210GS
807 545	4333.30.00	430WGTZ
807 558	4326.30.00	430WGTZ
807 558	4327.30.00	430GTZ
807 571	4311.30.00	430W2GTZ
807 573	4312.30.00	430W2GTZ
807 575	4306.30.00	430WGTZ
807 722	3886.30.00	380GSZ
826 585	2400.90.05	
827 052	4300.90.51	
829 309 TUR.	3133.30.00	310GSBL
829 358	3961.30.00	395GTZ
829 365	3884.30.00	15" 380GSZ
829 366	3597.30.00	350 WGTZ
829 367	3133.30.00	310GSBL
829 367 TUR.	3133.30.00	310GSBL
830 007	9101.40.00	KZI - 5
830 010	8934.40.00	KZISZ - 5
831 030	4313.20.00	MFZ430
831 314 TUR.	3188.20.00	MFZ 310
831 317	3868.20.00	15" GM380
831 320	3574.20.00	14" MF 350
831 322	3574.20.00	14" MF 350

Comparison list by RUEN

RUEN reference	Parameter	Comparison refer.
----------------	-----------	-------------------

BORG&BEG

2159.30.00	215CE	HB8833
2171.20.00	MF215K	HE4521
2172.30.00	215D	HB4522
2353.20.00	MFZ235	HE5475
2514.20.00	H250K	HA 2526

LUK

2034.30.00	200CE	320 0178 10
2171.20.00	MF215K	122 0026 12
2172.30.00	215D	322 0148 10
2281.30.00	228PSD	323 0062 16
2307.30.00	228CB	323 0127 16
2507.20.00	HBX250	125 0002 20
2528.30.00	250BHZX	325 0002 26
2810.20.00	H280K	128 0011 50
2810.30.00	280CBL	328 0110 50
2837.20.00	MFZ280	128 0219 20
3101.20.00	GFX310	131 0030 20
3124.30.00	310GSBL	331 0001 26
3169.20.00	MF310	131 0223 50
3305.20.00	GMF330	133 0205 20
3519.30.00	350GSZ	335 0002 26
3580.20.00	GMF350	135 0201 20
3821.30.00	380GSZ	338 0003 26
4235.20.00	GF420KR	142 0028 20
4258.30.00	420GSZ	342 0011 26
6901.40.00	KZI - 3	500 0173 20
6908.40.00	KZ - 3	500 0008 20

SACHS

1800.90.02		3000 322 001
1800.90.02		3000 324 001
1800.90.02		3000 325 001
1801.20.00	T180120	3082 966 001
1801.20.00	T180120	3082 967 001
1801.30.00	180DE2R	1862 768 001
2000.90.19		3000 154 001
2000.90.36		3000 169 002
2000.90.40		3000 169 004
2023.20.00	DB200	3082 859 101
2023.20.00	DB200	3082 859 141
2023.20.00	DB200	3082 859 143
2034.30.00	200CE	1862 867 004
2042.20.00	CP20	3082 133 041
2045.30.00	200D	1861 869 042
2080.30.00	200VTB	1862 954 142
2150.90.06		3000 152 002
2150.90.07		3000 441 002
2150.90.10		3000 120 001
2150.90.16		3000 463 001
2150.90.18		3000 290 001
2150.90.42		3000 569 001
2159.30.00	215CE	1861 776 032
2159.30.00	215CE	1878 037 441
2171.20.00	MF215K	3082 038 031
2171.20.00	MF215K	3082 131 031
2171.20.00	MF215K	3082 879 042
2172.30.00	215D	1861 857 132
2172.30.00	215D	1878 045 541
2178.30.00	215CE	1862 909 141
2178.30.00	215CE	1862 935 001
2178.30.00	215CE	1878 634 008
2178.30.00	215CE	1878 634 009

RUEN reference	Parameter	Comparison refer.
2185.20.00	CP215	1850 480 076
2185.20.00	CP215	3082 119 131
2185.20.00	CP215	3082 899 001
2280.90.02		3000 830 201
2280.90.03		3000 297 002
2280.90.04		3000 830 301
2281.30.00	228PSD	1861 515 332
2281.30.00	228PSD	1861 775 035
2281.30.00	228PSD	1861 856 132
2281.30.00	228PSD	1861 936 031
2281.30.00	228PSD	1861 936 042
2281.30.00	228PSD	1861 936 142
2281.30.00	228PSD	1862 936 142
2282.20.00	M228KR	3082 121 031
2283.20.00	M228KR	3082 054 132
2283.20.00	M228KR	3082 121 031
2283.20.00	M228KR	3082 156 031
2306.30.00	228GSB	1861 557 103
2306.30.00	228GSB	1861 557 233
2306.30.00	228GSB	1861 557 235
2306.30.00	228GSB	1861 557 236
2306.30.00	228GSB	1861 936 142
2306.30.00	228GSB	1878 634 052
2307.30.00	228CB	1861 557 237
2307.30.00	228CB	1861 620 233
2307.30.00	228CB	1861 620 234
2350.90.01		3000 830 001
2350.90.01		3000 951 249
2350.90.01		3400 700 433
2353.20.00	MFZ235	3083 039 031
2354.30.00	235CBL	1878 002 072
2400.90.04		3000 389 002
2400.90.05		3000 826 901
2400.90.06		3000 389 004
2402.20.00	MF240	1850 280 049
2402.20.00	MF240	1850 480 049
2402.30.00	240PSD	1850 481 008
2402.30.00	240PSD	1862 977 001
2403.20.00	MF240	3082 122 132
2403.20.00	MF240	3082 196 131
2413.30.00	240TD	1862 347 131
2500.90.01		1800 125 201
2507.20.00	HBX250	1882 205 234
2507.20.00	HBX250	1882 600 122
2514.20.00	H250K	1850 280 784
2514.20.00	H250K	1882 814 001
2514.30.00	250CBL	1850 281 917
2514.30.00	250CBL	1862 967 002
2518.20.00	G250	1881 010 139
2518.30.00	250GSZ	1861 224 033
2518.30.00	250GSZ	1861 224 034
2518.30.00	250GSZ	1861 224 048
2518.30.00	250GSZ	1861 244 101
2518.30.00	250GSZ	1878 074 741
2525.20.00	MF250	3499 373 055
2528.30.00	250BHZX	1861 291 033
2528.30.00	250BHZX	1861 291 036
2528.30.00	250BHZX	1861 291 136
2528.30.00	250BHZX	1878 634 082
2650.90.01		3400 700 429
2650.90.15		3400 117 701
2650.90.15		3400 700 444
2650.90.15		3400 700 447
2651.20.00	MF265	3482 907 001
2654.20.00	MF270	3482 911 001
2655.30.00	265TB	1862 967 001

Comparison list by RUEN

RUEN reference	Parameter	Comparison refer.
SACHS >>		
2656.30.00	270CTB	1862 811 001
2658.20.00	MFZ265	3482 998 701
2678.30.00	265VTP	1878 997 101
2800.90.31		3400 700 432
2802.20.00	G280	1880 083 102
2802.20.00	G280	1880 083 132
2803.30.00	280BHZ	1861 060 003
2809.20.00	H280	1882 806 001
2810.20.00	H280K	1850 280 683
2810.20.00	H280K	1882 815 001
2810.30.00	280CBL	1850 281 829
2810.30.00	280CBL	1862 722 001
2812.20.00	HVB280	1882 230 232
2812.20.00	HVB280	1882 230 238
2812.30.00	280Z	1860 062 037
2813.30.00	280BHZ	1861 254 034
2813.30.00	280BHZ	1861 254 037
2813.30.00	280BHZ	1861 632 032
2819.30.00	280GSZ	1861 296 033
2819.30.00	280GSZ	1861 296 034
2821.20.00	MF280K	3482 999 027
2821.30.00	280GTZ	1861 999 221
2822.30.00	280GTZ	1861 632 032
2822.30.00	280GTZ	1861 919 031
2822.30.00	280GTZ	1861 919 032
2822.30.00	280GTZ	1861 919 033
2822.30.00	280GTZ	1861 919 034
2822.30.00	280GTZ	1861 919 134
2822.30.00	280GTZ	1878 074 641
2837.20.00	MFZ280	3482 054 031
2837.20.00	MFZ280	3482 054 131
2845.20.00	HVB280	1882 317 101
2845.20.00	HVB280	1882 317 131
2953.20.00	GF295	1882 201 102
2953.20.00	GF295	1882 201 132
2954.20.00	GF295	1882 201 101
2954.30.00	295BHZ	1861 279 031
2954.30.00	295BHZ	1861 279 133
2954.30.00	295BHZ	1861 279 135
2954.30.00	295BHZ	1864 279 033
2955.20.00	GF295	1882 201 103
2955.20.00	GF295	1882 201 133
3100.90.12		3400 122 401
3100.90.13		3400 700 347
3101.20.00	GFX310	1882 305 101
3101.20.00	GFX310	1882 305 131
3102.30.00	310GSZ	1861 535 001
3104.30.00	310GSBL	1861 303 202
3104.30.00	310GSBL	1861 303 246
3108.30.00	310GSZ	1861 600 033
3113.30.00	310GSBL	1861 577 037
3113.30.00	310GSBL	1861 577 136
3113.30.00	310GSBL	1878 039 731
3120.20.00	GFX310	1882 252 301
3120.20.00	GFX310	1882 252 331
3122.20.00	GFX310	1882 252 303
3122.20.00	GFX310	1882 252 333
3124.30.00	310GSBL	1861 303 232
3124.30.00	310GSBL	1861 303 246
3124.30.00	310GSBL	1861 303 248
3126.30.00	310GSBL	1861 303 243
3126.30.00	310GSBL	1861 303 248
3131.20.00	G310	1880 092 405
3131.20.00	G310	1880 092 435

RUEN reference	Parameter	Comparison refer.
3136.30.00	310WGSZ	1861 964 034
3136.30.00	310WGSZ	1862 299 032
3140.30.00	310W2GSZ	1861 653 102
3162.20.00	MF310	3482 008 003
3162.20.00	MF310	3482 008 033
3164.20.00	MF310	3482 008 008
3164.20.00	MF310	3482 008 038
3166.20.00	MF310	3482 008 006
3169.20.00	MF310	3482 008 033
3169.20.00	MF310	3482 906 001
3176.20.00	MFZ310	3482 055 102
3176.20.00	MFZ310	3482 055 132
3205.40.00	KZIS - 0	3151 843 001
3206.40.00	KZIS - 1	3151 803 001
3209.40.00	KZAS - 1	3151 838 001
3211.40.00	KZIS - 0	3151 275 601
3212.40.00	KZI - 0	3151 868 001
3214.40.00	KZI/T - 1	3151 000 206
3214.40.00	KZI/T - 1	3151 034 031
3214.40.00	KZI/T - 1	3151 133 331
3216.40.00	KZAS - 0	3151 846 001
3224.40.00	KZAS - 00	3151 847 001
3233.40.00	KZAS - 0B	3151 859 001
3300.20.00	GFM330	3482 012 201
3300.20.00	GFM330	3482 012 211
3300.20.00	GFM330	3482 012 231
3300.20.00	GFM330	3482 012 237
3300.30.00	330GSZ	1861 571 101
3300.30.00	330GSZ	1861 571 131
3300.30.00	330GSZ	1861 571 236
3300.90.04		3400 124 301
3300.90.08		3400 700 322
3304.20.00	GMF330	3482 012 240
3305.20.00	GMF330	3482 012 240
3306.30.00	330GSZ	1861 571 110
3308.30.00	330GSZ	1861 778 003
3308.30.00	330GSZ	1861 874 032
3309.30.00	330GSZ	1862 438 031
3309.30.00	330GSZ	1862 438 032
3313.20.00	MFZ330	3482 093 032
3325.30.00	330WGSZ	1861 963 033
3328.30.00	330WGSZ	1861 778 002
3328.30.00	330WGSZ	1861 778 003
3328.30.00	330WGSZ	1861 778 031
3328.30.00	330WGSZ	1861 874 031
3328.30.00	330WGSZ	1861 874 032
3500.90.04		3400 125 501
3500.90.11		3400 125 001
3500.90.11		3400 125 101
3500.90.42		3400 700 339
3500.90.51		1800 125 001
3505.20.00	G350KR	1881 039 003
3505.20.00	G350KR	1881 039 532
3505.20.00	G350KR	1881 039 539
3505.20.00	G350KR	1882 039 532
3506.20.00	G350	1881 039 531
3510.30.00	350W2GSZ	1861 489 235
3510.30.00	350W2GSZ	1861 498 202
3510.30.00	350W2GSZ	1861 498 232
3510.30.00	350W2GSZ	1861 498 235
3510.30.00	350W2GSZ	1878 001 144
3511.10.00	GF2/350	1888 019 344
3512.30.00	350W2GSZ	1878 005 367
3512.30.00	350W2GSZ	1861 350 201
3512.30.00	350W2GSZ	1861 350 231
3512.30.00	350W2GSZ	1861 350 233

Comparison list by RUEN

RUEN reference	Parameter	Comparison refer.
SACHS >>		
3512.30.00	350W2GSZ	1878 005 367
3515.10.00	GF2/350	1880 019 445
3515.10.00	GF2/350	1888 019 445
3515.10.00	GF2/350	1888 019 542
3515.50.00	GF2-350	1859 170 204
3516.10.00	GF2/350	1888 019 539
3516.30.00	350WGSZ	1861 438 204
3516.30.00	350WGSZ	1861 438 234
3516.30.00	350WGSZ	1878 005 367
3517.30.00	350WGSZ	1861 962 033
3517.30.00	350WGSZ	1878 001 144
3519.30.00	350GSZ	1861 288 105
3519.30.00	350GSZ	1861 288 135
3519.30.00	350GSZ	1861 288 136
3519.30.00	350GSZ	1878 001 074
3521.20.00	GF350KR	1882 110 202
3521.20.00	GF350KR	1882 110 532
3521.20.00	GF350KR	1882 110 542
3522.20.00	GF350KR	1882 234 403
3522.20.00	GF350KR	1882 234 433
3525.20.00	GF350KR	1882 311 101
3528.30.00	350GSZ	1861 641 031
3528.30.00	350GSZ	1861 641 135
3552.30.00	350	1861 034 003
3552.30.00	350	1861 034 047
3552.30.00	350	1861 034 147
3559.30.00	350GSZ	1861 437 002
3559.30.00	350GSZ	1878 001 083
3562.20.00	GMF350	3499 377 832
3562.20.00	GMF350	3482 002 103
3562.20.00	GMF350	3482 002 203
3562.20.00	GMF350	3482 002 233
3562.30.00	350GSZ	1861 437 106
3562.30.00	350GSZ	1861 437 236
3563.20.00	GMF350	1882 209 334
3563.20.00	GMF350	3482 002 102
3563.20.00	GMF350	3482 002 104
3563.20.00	GMF350	3482 002 132
3563.20.00	GMF350	3482 002 135
3563.20.00	GMF350	3482 002 137
3563.20.00	GMF350	3482 002 202
3563.20.00	GMF350	3482 002 204
3563.20.00	GMF350	3482 002 232
3563.20.00	GMF350	3482 002 234
3563.20.00	GMF350	3482 002 235
3563.20.00	GMF350	3482 002 237
3563.30.00	350GSZ	1861 325 105
3563.30.00	350GSZ	1861 325 135
3563.30.00	350GSZ	1861 325 142
3563.30.00	350GSZ	1861 777 037
3563.30.00	350GSZ	1861 777 041
3563.30.00	350GSZ	1878 001 071
3563.30.00	350GSZ	1878 076 031
3564.30.00	350GSZ	1861 325 106
3564.30.00	350GSZ	1861 325 141
3564.30.00	350GSZ	1861 777 043
3564.30.00	350GSZ	1878 001 070
3564.30.00	350GSZ	1878 001 078
3565.20.00	GMF350	3482 002 107
3565.20.00	GMF350	3482 002 204
3565.20.00	GMF350	3482 002 237
3570.20.00	GMF350	3482 038 001
3570.30.00	350Z	1864 351 006
3573.20.00	MF350	3482 060 131

RUEN reference	Parameter	Comparison refer.
3573.20.00	MF350	3482 060 132
3573.20.00	MF350	3482 060 233
3573.20.00	MF350	3482 124 041
3574.20.00	14" MF 350	3482 124 001
3574.20.00	14" MF 350	3482 124 041
3575.30.00	350WGSZ	1861 714 133
3575.30.00	350WGSZ	1878 001 147
3575.30.00	350WGSZ	1878 063 501
3576.30.00	350WGSZ	1878 063 501
3580.20.00	GMF350	3482 000 953
3580.20.00	GMF350	3482 011 201
3580.20.00	GMF350	3482 011 331
3580.20.00	GMF350	3482 051 131
3580.20.00	GMF350	3482 051 201
3583.30.00	350GSZ	1861 787 004
3583.30.00	350GSZ	1861 787 031
3583.30.00	350GSZ	1861 787 034
3585.30.00	350GSZ	1878 001 070
3585.30.00	350GSZ	1861 742 032
3585.30.00	350GSZ	1861 866 032
3585.30.00	350GSZ	1878 001 077
3587.30.00	350GSZ	1862 236 031
3587.30.00	350GSZ	1878 001 077
3588.30.00	350GSZ	1861 234 001
3588.30.00	350GSZ	1861 234 010
3588.30.00	350GSZ	1878 001 074
3590.30.00	350GSZ	1861 957 231
3596.30.00	350WGSZ	1862 491 031
3596.30.00	350WGSZ	1878 000 841
3596.30.00	350WGSZ	1878 001 145
3596.30.00	350WGSZ	1898 917 329
3597.30.00	350 WGTZ	1861 961 033
3597.30.00	350 WGTZ	1878 001 144
3606.20.00	MF362	3482 000 462
3607.30.00	MF362	3482 126 331
3607.30.00	362WGTZ	1878 047 333
3607.30.00	362WGTZ	1878 063 531
3607.30.00	362WGTZ	1878 079 331
3608.20.00	MF362	3482 000 461
3608.20.00	MF362	3482 125 512
3610.20.00	MFZ362	3482 120 031
3610.30.00	362GTZ	1862 528 032
3610.30.00	362GTZ	1862 541 031
3610.30.00	362GTZ	1862 541 032
3610.30.00	362GTZ	1878 044 631
3620.90.01		3400 121 401
3620.90.02		3400 127 701
3620.90.10		3400 121 801
3627.30.00	362WGTB	1878 048 741
3627.30.00	362WGTB	1878 052 842
3800.90.10		3400 037 031
3800.90.48		3400 037 032
3800.90.52		3400 124 701
3802.20.00	G380KR	1882 325 033
3804.20.00	G380KR	1882 325 034
3804.20.00	G380KR	1882 325 134
3805.30.00	380WGSZ	1861 351 305
3805.30.00	380WGSZ	1861 351 342
3807.20.00	G380KR	1881 041 656
3807.20.00	G380KR	1881 041 526
3807.20.00	G380KR	1881 041 556
3807.20.00	G380KR	1881 041 656
3810.20.00	G380KR	1882 325 032
38106.30.00	380WGTZ	1878 001 152
38115.30.00	380GSZ	1862 235 001
38115.30.00	380GSZ	1878 000 957

Comparison list by RUEN

RUEN reference	Parameter	Comparison refer.
SACHS >>		
3812.30.00	380GSZ	1861 321 139
3812.30.00	380GSZ	1861 329 139
3812.30.00	380GSZ	1878 000 104
3816.30.00	380GSZ	1861 579 131
3816.30.00	380GSZ	1861 861 031
3816.30.00	380GSZ	1861 861 032
3816.30.00	380GSZ	1878 000 957
3816.30.00	380GSZ	1878 000 959
3821.20.00	GF380KR	1882 302 101
3821.20.00	GF380KR	1882 302 131
3821.20.00	GF380KR	1882 331 033
3821.30.00	380GSZ	1861 494 103
3821.30.00	380GSZ	1861 494 140
3821.30.00	380GSZ	1862 308 031
3821.30.00	380GSZ	1878 000 105
3822.20.00	GF380KR	1882 166 707
3822.20.00	GF380KR	1882 166 737
3822.30.00	380GSZ	1861 219 009
3822.30.00	380GSZ	1861 219 157
3822.30.00	380GSZ	1878 000 104
3829.20.00	GF380KR	1882 327 001
3831.30.00	380GSZ	1861 219 111
3831.30.00	380GSZ	1861 219 141
3831.30.00	380GSZ	1861 219 179
3831.30.00	380GSZ	1861 470 234
3835.20.00	GF380	1882 302 131
3835.20.00	GF380	1882 302 134
3835.20.00	GF380	1882 331 033
3852.30.00	380GS	1861 599 102
3852.30.00	380GS	1878 000 105
3855.30.00	380GS	1862 135 003
3855.30.00	380GS	1862 135 035
3857.10.00	GF2/380	1888 042 009
3857.20.00	G380KR	1882 341 001
3857.30.00	380W2GSZ	1861 486 231
3857.30.00	380W2GSZ	1878 001 152
3857.50.00	GF2/380	1859 250 101
3857.50.00	GF2/380	1859 250 102
3860.20.00	GM380K	3482 021 001
3860.20.00	GM380K	3482 021 031
3861.30.00	380W2GSZ	1861 435 333
3861.30.00	380W2GSZ	1861 435 334
3866.20.00	GM380K	3482 037 041
3866.20.00	GM380K	3482 037 141
3870.30.00	380/210GSZ	1861 489 101
3870.30.00	380/210GSZ	1861 863 233
3870.30.00	380/210GSZ	1878 000 967
3878.20.00	GMF380	3482 017 034
3882.10.00	GF2/380	1888 055 005
3882.10.00	GF2/380	1888 055 035
3882.10.00	GF2/380	1888 055 041
3882.20.00	GF2/380	1882 349 001
3882.20.00	GF2/380	1882 349 002
3882.20.00	GF2/380	1882 349 003
3882.50.00	GF2/380	1859 250 100
3886.30.00	380GSZ	1861 635 031
3886.30.00	380GSZ	1861 635 035
3886.30.00	380GSZ	1878 000 961
3888.30.00	380WGSZ	1861 923 002
3888.30.00	380WGSZ	1861 923 032
3888.30.00	380WGSZ	1862 356 031
3889.30.00	380GSZ	1862 122 031
3889.30.00	380GSZ	1862 122 131
3889.30.00	380GSZ	1862 122 132

RUEN reference	Parameter	Comparison refer.
3889.30.00	380GSZ	1862 122 134
3891.30.00	380GS	1862 123 131
3892.30.00	380GSZ	1861 699 101
3892.30.00	380GSZ	1861 699 131
3895.20.00	G380KR	1882 325 039
3895.20.00	G380KR	1882 325 139
3897.30.00	380GSZ	1861 912 034
3897.30.00	380GSZ	1861 912 035
3897.30.00	380GSZ	1878 000 105
3899.30.00	380GSZ	1861 470 133
3899.30.00	380GSZ	1861 470 234
3951.20.00	MF395	3482 000 187
3951.20.00	MF395	3482 000 463
3951.20.00	MF395	3482 123 833
3951.30.00	395WGTZ	1862 506 131
3951.30.00	395WGTZ	1878 046 631
3952.20.00	MF395	3482 123 832
3952.20.00	MF395	3482 000 197
3952.20.00	MF395	3482 000 464
3952.30.00	395WGTZ	1878 000 036
3953.20.00	MF395	3482 000 474
3953.20.00	MF395	3482 123 839
3954.30.00	395WGTZ	1878 000 294
3961.30.00	395GTZ	1878 003 784
3961.30.00	395GTZ	1878 023 831
3962.30.00	395GTZ	1878 039 631
4000.90.60		3400 123 601
4000.90.61		3400 123 501
4001.10.00	MFZ2/400X	3488 017 333
4007.30.00	400WGTZ	1862 390 031
4007.30.00	400WGTZ	1878 032 032
4008.30.00	400 WGVZ	1862 364 133
4010.10.00	MFZ2/400X	3488 017 432
4010.30.00	400WGVZ	1862 303 031
4011.30.00	400GVZ	1862 302 031
4020.30.00	400GVZ	1862 193 105
4020.30.00	400GVZ	1878 005 805
4021.30.00	400GVZ	1862 190 105
4036.30.00	400 WGTZ	1878 002 643
4051.30.00	400WGVZ	1862 454 031
4051.30.00	400WGVZ	1878 013 031
4051.30.00	400WGVZ	1878 013 132
4051.30.00	400WGVZ	1878 043 231
4052.30.00	400GVZ	1862 450 031
4054.30.00	400WGTZ	1862 382 031
4054.30.00	400WGTZ	1878 003 779
4060.60.00	MFZ400X	3483 028 031
4200.90.01		1800 107 133
4200.90.17		1800 125 301
4200.90.22		3400 700 305
4200.90.49		3400 119 001
4200.90.72		1800 125 601
4200.90.72		3400 125 601
4200.90.77		3400 125 701
4200.90.79		3400 042 031
4200.90.84		3400 125 901
4201.20.00	G420KR	1882 308 102
4203.20.00	G420KR	1882 226 402
4203.20.00	G420KR	1882 226 533
4203.30.00	420GS	1861 088 007
4203.30.00	420GS	1861 206 111
4203.30.00	420GS	1861 206 211
4203.30.00	420GS	1861 409 132
4205.20.00	G420KR	1882 308 103
4205.20.00	G420KR	1882 308 133
4208.30.00	420GS	1861 206 112

Comparison list by RUEN

RUEN reference	Parameter	Comparison refer.
SACHS >>		
4208.30.00	420GS	1861 206 212
4208.30.00	420GS	1861 206 242
4208.30.00	420GS	1878 001 138
4209.30.00	420GS	1861 206 113
4211.20.00	G420KR	1882 226 433
42110.20.00	GMF430	3482 124 534
42111.20.00	GMF430	3482 124 549
42130.30.00	420GTZ	1878 002 706
4221.30.00	420 GSZ	1861 409 105
4222.20.00	GF420KR	1882 301 237
4222.20.00	GF420KR	1882 330 002
4222.20.00	GF420KR	1882 330 032
4224.20.00	GF420KR	1882 301 239
4224.20.00	GF420KR	1882 330 031
4224.20.00	GF420KR	3482 124 534
4225.20.00	GF420KR	1882 330 033
4225.20.00	GF420KR	3482 124 534
4226.20.00	GF420KR	1882 316 033
4226.20.00	GF420KR	3482 124 541
4231.30.00	420GSZ	1861 410 002
4231.30.00	420GSZ	1861 410 047
4234.20.00	GF420KR	1882 301 208
4234.20.00	GF420KR	1882 301 238
4234.20.00	GF420KR	3482 124 541
4235.20.00	GF420KR	1882 301 209
4235.20.00	GF420KR	1882 301 239
4235.30.00	420/210GS	1861 680 038
4236.20.00	GF420KR	1882 326 001
4236.20.00	GF420KR	1882 326 331
4236.20.00	GF420KR	3482 085 033
4236.30.00	420/210GSZ	1861 569 031
4236.30.00	420/210GSZ	1861 569 038
4236.30.00	420/210GSZ	1878 634 017
4237.20.00	GF420KR	1882 316 005
4237.20.00	GF420KR	3482 124 531
4244.20.00	GFX420KR	1882 342 134
4244.30.00	420/210GSZ	1861 527 002
4244.30.00	420/210GSZ	1861 527 033
4244.30.00	420/210GSZ	1861 986 135
4245.20.00	GFX420KR	1882 342 105
4248.20.00	GFX420KR	1882 303 103
4248.20.00	GFX420KR	3482 118 031
4249.30.00	420W2GSZ	1878 001 154
4249.30.00	420W2GSZ	1861 521 231
4249.30.00	420W2GSZ	1861 521 234
4249.30.00	420W2GSZ	1878 001 154
4250.20.00	GFX420KR	1882 303 102
4250.20.00	GFX420KR	3482 124 522
4250.30.00	420WGSZ	1861 639 004
4250.30.00	420WGSZ	1861 639 006
4250.30.00	420WGSZ	1861 639 031
4250.30.00	420WGSZ	1861 639 032
4250.30.00	420WGSZ	1861 639 035
4250.30.00	420WGSZ	1861 639 107
4250.30.00	420WGSZ	1861 639 148
4250.30.00	420WGSZ	1878 003 657
4253.20.00	GFX420KR	1882 342 133
4253.20.00	GFX420KR	1882 342 134
4253.20.00	GFX420KR	3482 124 516
4254.20.00	GF420X	1882 301 239
4254.20.00	GF420X	1882 303 108
4254.20.00	GF420X	1882 303 141
4254.30.00	420GSZ	1861 672 031
4254.30.00	420GSZ	1861 672 033

RUEN reference	Parameter	Comparison refer.
4255.30.00	420GS	1861 482 034
4255.30.00	420GS	1891 986 135
4256.20.00	GMF420K	3482 018 132
4256.20.00	GMF420K	3482 018 202
4256.20.00	GMF420K	3482 018 205
4256.20.00	GMF420K	3482 119 031
4257.20.00	GMF420K	3482 018 101
4257.20.00	GMF420K	3482 018 231
4257.20.00	GMF420K	3482 119 032
4257.30.00	420GSZ	1861 410 015
4257.30.00	420GSZ	1861 410 048
4258.30.00	420GSZ	1861 410 006
4258.30.00	420GSZ	1861 410 016
4258.30.00	420GSZ	1861 410 046
4259.30.00	420GSZ	1861 986 140
4259.30.00	420GSZ	1878 086 742
4261.20.00	GMF420K	3482 001 101
4261.20.00	GMF420K	3482 001 139
4261.20.00	GMF420K	3482 124 514
4261.30.00	420GSZ	1861 598 103
4261.30.00	420GSZ	1861 598 133
4261.30.00	420GSZ	1861 670 002
4261.30.00	420GSZ	1861 680 002
4261.30.00	420GSZ	1861 680 036
4261.30.00	420GSZ	1861 680 037
4261.30.00	420GSZ	1861 680 107
4261.30.00	420GSZ	1861 680 149
4261.30.00	420GSZ	1878 003 238
4263.20.00	GMF420K	3482 001 104
4263.20.00	GMF420K	3482 001 134
4263.20.00	GMF420K	3482 001 234
4263.20.00	GMF420K	3482 119 034
4264.20.00	GFM420K	3482 124 542
4266.30.00	420/210GSZ	1861 760 034
4268.30.00	420GSZ	1861 560 204
4268.30.00	420GSZ	1861 560 234
4272.30.00	420WGSZ	1861 715 032
4272.30.00	420WGSZ	1861 715 035
4272.30.00	420WGSZ	1878 003 657
4277.20.00	GFX420KR	1882 335 233
4277.20.00	GFX420KR	1882 335 236
4278.20.00	GFX420KR	1882 335 234
4278.20.00	GFX420KR	3482 125 131
4278.30.00	420W2GSZ	1861 724 003
4278.30.00	420W2GSZ	1861 724 104
4278.30.00	420W2GSZ	1861 724 137
4279.30.00	420WGSZ	1862 211 031
4281.30.00	420WGVZ	1861 911 232
4281.30.00	420WGVZ	1861 911 245
4281.30.00	420WGVZ	1861 911 303
4281.30.00	420WGVZ	1862 227 034
4282.30.00	420WGVZ	1861 911 204
4282.30.00	420WGVZ	1861 911 304
4282.30.00	420WGVZ	1878 086 941
4283.30.00	420WGSZ	1861 480 331
4283.30.00	420WGSZ	1861 480 335
4283.30.00	420WGSZ	1878 001 155
4284.30.00	420WGSZ	1862 374 003
4291.20.00	GTF420	3482 006 032
4291.20.00	GTF420	3482 006 036
4291.30.00	420GSZ	1861 526 003
4291.30.00	420GSZ	1861 526 014
4291.30.00	420GSZ	1861 903 002
4291.30.00	420GSZ	1861 903 032
4291.30.00	420GSZ	1861 903 033
4291.30.00	420GSZ	1878 003 276

Comparison list by RUEN

RUEN reference	Parameter	Comparison refer.
SACHS >>		
4291.30.00	420GSZ	1878 037 001
4296.20.00	GF420	1882 301 240
4297.30.00	420GSZ	1861 941 032
4297.30.00	420GSZ	1861 941 033
4297.30.00	420GSZ	1878 001 136
4298.20.00	GF420	1882 316 038
4298.20.00	GF420	3482 124 532
4299.30.00	420GSZ	1861 572 431
4299.30.00	420GSZ	1861 860 131
4300.20.00	MFZ430	3482 081 233
4300.20.00	MFZ430	3482 083 031
4300.20.00	MFZ430	3482 083 113
4300.30.00	430GTZ	1862 315 101
4300.30.00	430GTZ	1878 085 641
4300.90.01		3400 122 601
4300.90.01		3400 124 001
4300.90.03		3400 700 304
4300.90.03		3400 122 101
4300.90.05		3400 122 201
4300.90.09		3400 710 004
4300.90.09		3400 122 001
4300.90.105		3400 700 459
4300.90.11		3400 123 701
4300.90.12		3400 700 404
4300.90.13		3400 700 403
4300.90.16		3400 700 342
4300.90.18		3400 123 001
4300.90.180		3400 700 509
4300.90.182		3400 700 505
4300.90.183		3400 700 506
4300.90.184		3400 700 507
4300.90.185		3400 700 510
4300.90.21		3400 106 031
4300.90.21		3400 127 201
4300.90.30		3400 124 101
4300.90.33		3400 043 032
4300.90.34		3400 127 101
4300.90.400		3400 700 349
4300.90.405		3400 700 643
4300.90.44		3400 700 345
4300.90.47		3400 116 901
4300.90.48		3400 117 202
4300.90.49		3400 122 301
4300.90.51		3400 700 354
4300.90.54		3400 700 330
4300.90.56		3400 700 381
4300.90.56		3400 700 450
4300.90.57		3400 700 451
4300.90.58		3400 127 801
4300.90.59		3400 128 001
4300.90.60		3400 700 409
4300.90.61		3400 123 401
4300.90.62		3400 700 350
4300.90.65		3400 700 344
4300.90.75		3400 700 329
4300.90.77		3400 700 445
4301.20.00	MFZ430	3482 083 032
4301.20.00	MFZ430	3482 083 119
4303.20.00	MFZ430	3482 000 573
4303.20.00	MFZ430	3482 083 032
4303.20.00	MFZ430	3482 083 041
4304.20.00	MFZ430	3482 081 231
4304.20.00	MFZ430	3482 083 118
4304.26.00	MFZ430	3482 123 234

RUEN reference	Parameter	Comparison refer.
4304.26.00	MFZ430	3482 123 235
4304.30.00	430WGTZ	1862 216 032
4304.30.00	430WGTZ	1878 005 668
4304.30.00	430WGTZ	1878 065 131
4304.30.00	430WGTZ	1878 086 741
4305.20.00	MFZ430	3482 081 232
4305.30.00	430W2GTZ	1862 188 032
4305.30.00	430W2GTZ	1862 215 032
4305.30.00	430W2GTZ	1862 283 133
4305.30.00	430W2GTZ	1862 519 137
4305.30.00	430W2GTZ	1862 519 259
4305.30.00	430W2GTZ	1878 000 116
4305.30.00	430W2GTZ	1878 002 729
4305.30.00	430W2GTZ	1878 004 832
4305.30.00	430W2GTZ	1878 022 841
4305.30.00	430W2GTZ	1878 080 035
4305.30.00	430W2GTZ	1878 634 027
4306.30.00	430WGTZ	1878 080 033
4307.20.00	MFZ430	3482 000 852
4307.20.00	MFZ430	3482 081 233
43100.20.00	MFZ430E	3482 000 042
4311.20.00	MFZ430	3482 083 034
4311.30.00	430W2GTZ	1878 020 241
4312.30.00	430W2GTZ	1862 216 032
4312.30.00	430W2GTZ	1878 026 241
4313.20.00	MFZ430	3482 000 151
4313.20.00	MFZ430	3482 000 251
4313.20.00	MFZ430	3482 083 034
4313.20.00	MFZ430	3482 083 039
4313.26.00	MFZ430	3482 083 039
43134.30.00	430WGTZ	1878 004 573
4314.30.00	430WGTZ	1878 061 841
4316.30.00	430WGTZ	1878 000 055
4316.30.00	430WGTZ	1878 080 031
4316.30.00	430WGTZ	1878 237 831
4319.20.00	MFZ430	3482 000 196
4319.20.00	MFZ430	3482 000 361
4322.30.00	430	1878 040 334
4322.30.00	430WGTZ	1878 040 334
4323.30.00	430WGTZ	1862 530 231
4325.30.00	430WGTZ	1878 000 634
4325.30.00	430WGTZ	1878 001 215
4326.30.00	430WGTZ	1878 085 741
4327.30.00	430GTZ	1861 992 432
4327.30.00	430GTZ	1878 054 951
4328.20.00	MFZ430	3482 083 150
4329.30.00	430WGTZ.	1878 000 948
4329.30.00	430WGTZ.	1878 003 867
4329.30.00	430WGTZ.	1878 006 584
4329.60.00	MFZ430	3483 030 032
4331.30.00	430WGTZ	1878 002 504
4331.30.00	430WGTZ	1878 002 733
4331.30.00	430WGTZ	1878 054 031
4331.30.00	430WGTZ	1878 634 026
4331.60.00	MFZ430	3483 020 036
4332.30.00	430GTZ	1878 000 205
4332.30.00	430GTZ	1878 003 647
4332.60.00	MFZ430	3483 034 032
4332.60.00	MFZ430	3483 034 033
4333.30.00	430WGTZ	1862 326 032
4333.30.00	430WGTZ	1862 461 031
4333.30.00	430WGTZ	1862 461 132
4333.30.00	430WGTZ	1878 003 066
4333.30.00	430WGTZ	1878 037 631
4333.30.00	430WGTZ	1878 063 231
4333.60.00	MFZ430	3483 034 034

Comparison list by RUEN

RUEN reference	Parameter	Comparison refer.
SACHS >>		
4334.30.00	430GTZ	1878 040 631
4334.30.00	430GTZ	1878 054 933
4335.30.00	430GTZ	1861 988 031
4335.30.00	430GTZ	1861 988 034
4335.30.00	430GTZ	1878 000 206
4336.60.00	MFZ430	3483 034 042
4337.60.00	MFZ430	3483 034 045
4339.20.00	MFZ430	3482 000 195
4339.20.00	MFZ430	3482 000 246
4339.20.00	MFZ430	3482 123 534
4346.30.00	430WGTZ	1862 108 031
4346.30.00	430WGTZ	1862 108 034
4346.30.00	430WGTZ	1862 109 034
4346.30.00	430WGTZ	1862 217 032
4346.30.00	430WGTZ	1862 217 033
4346.30.00	430WGTZ	1862 217 235
4346.30.00	430WGTZ	1862 217 335
4346.30.00	430WGTZ	1862 219 337
4346.30.00	430WGTZ	1862 417 101
4346.30.00	430WGTZ	1878 001 030
4346.30.00	430WGTZ	1878 004 832
4346.30.00	430WGTZ	1878 023 731
4346.30.00	430WGTZ	1878 037 834
4346.30.00	430WGTZ	1878 037 838
4346.30.00	430WGTZ	1878 054 953
4346.30.00	430WGTZ	1878 080 034
4346.30.00	430WGTZ	1878 080 035
4346.30.00	430WGTZ	1878 080 037
43460.30.00	430WGTZ	1878 039 831
43460.30.00	430WGTZ	1862 441 031
43460.30.00	430WGTZ	1862 441 131
43460.30.00	430WGTZ	1878 037 844
43460.30.00	430WGTZ	1878 037 857
43460.30.00	430WGTZ	1878 080 034
43461.30.00	430WGTZ	1878 004 832
43461.30.00	430WGTZ	1878 005 541
4347.30.00	430WGTZ	1862 215 032
4347.30.00	430WGTZ	1862 519 243
4347.30.00	430WGTZ	1862 519 259
4347.30.00	430WGTZ	1878 002 791
4347.30.00	430WGTZ	1878 037 858
4347.30.00	430WGTZ	1878 065 531
4347.30.00	430WGTZ	1878 080 037
4348.30.00	430WGTZ	1878 001 496
4348.30.00	430WGTZ	1878 005 540
4356.30.00	430WGTZ	1862 226 131
4356.30.00	430WGTZ	1862 226 346
4356.30.00	430WGTZ	1862 226 511
4356.30.00	430WGTZ	1862 418 031
4356.30.00	430WGTZ	1862 494 031
4356.30.00	430WGTZ	1878 000 055
4356.30.00	430WGTZ	1878 031 002
4356.30.00	430WGTZ	1878 031 032
4356.30.00	430WGTZ	1878 031 048
4356.30.00	430WGTZ	1878 037 831
4356.30.00	430WGTZ	1878 037 854
4356.30.00	430WGTZ	1878 080 031
4386.30.00	430WGTZ	1878 001 938
4386.30.00	430WGTZ	1878 002 139
4386.30.00	430WGTZ	1878 038 041
4398.30.00	430WGTZ	1878 007 046
4500.40.00	KZIZ - 3	3151 213 031
4500.40.00	KZIZ - 3	3151 600 529
4502.40.00	KZI - 1	3151 065 031

RUEN reference	Parameter	Comparison refer.
5700.40.00	KZIZ - 3	3151 170 131
5800.40.00	KZA - 2	1850 282 653
5901.40.00	KZA - 4	3151 824 003
5902.40.00	KZA - 4	3151 824 002
6901.40.00	KZI - 3	3151 044 031
6905.40.00	KZIS - 3	3151 199 001
6907.40.00	KZI - 3	3151 116 031
6907.40.00	KZI - 3	3151 999 116
6908.40.00	KZ - 3	3151 033 031
6909.40.00	KZI - 3	3151 095 043
6915.40.00	KZI - 4	3151 094 041
7451.40.00	KZIS-4	3151 221 001
7451.40.00	KZIS-4	3151 000 419
7802.40.00	KZA - 4	3151 824 005
7903.40.00	KZI-4	3151 600 540
7951.40.00	KZIS - 4	3151 000 395
7951.40.00	KZIS - 4	3151 152 102
8500.40.00	KZI - 4,5	3151 000 375
8500.40.00	KZI - 4,5	3151 027 131
8502.40.00	KZI - 4	3151 087 041
8505.40.00	KZI - 4,5	3151 000 395
8505.40.00	KZI - 4,5	3151 066 002
8505.40.00	KZI - 4,5	3151 066 032
8505.40.00	KZI - 4,5	3151 157 001
8509.40.00	KZI - 4,5	3151 043 031
8510.40.00	KZI - 4,5	3151 071 032
8510.40.00	KZI - 4,5	3151 114 031
8511.40.00	KZI - 4,5	3151 126 031
8512.40.00	KZI - 4,5	3151 127 031
8514.40.00	KZI - 4,5	3151 101 031
8514.40.00	KZI - 4,5	3151 000 512
8514.40.00	KZI - 4,5	3151 000 515
8514.40.00	KZI - 4,5	3151 007 301
8514.40.00	KZI - 4,5	3151 007 303
8514.40.00	KZI - 4,5	3151 058 001
8515.40.00	KZI - 4,5	3151 119 001
8520.40.00	KZI - 4,5	3151 108 031
8529.40.00	KZI - 4,5	3151 000 374
8529.40.00	KZI - 4,5	3151 112 031
8529.40.00	KZI - 4,5	3151 272 631
8531.40.00	KZI - 4,5	3151 098 031
8532.40.00	KZI - 4,5	3151 054 032
8533.40.00	KZI - 4,5	3151 000 958
8533.40.00	KZI - 4,5	3151 067 031
8540.40.00	KZIS-4	3151 000 396
8540.40.00	KZIS-4	3151 261 031
8631.47.00	HHISZ-4	3182 006 131
8631.47.00	HHISZ-4	3182 006 231
8631.47.00	HHISZ-4	3182 006 531
8631.47.00	HHISZ-4	3182 009 936
8631.47.00	HHISZ-4	3182 009 938
8641.47.00	PHIS-6/38	6482 000 087
8641.47.00	PHIS-6/38	6482 000 155
8900.40.00	KZI - 5	3151 105 041
8900.40.00	KZI - 5	3151 105 141
8905.40.00	KZIZ - 5	3151 246 031
8916.40.00	KZIZ - 5	3151 169 031
8916.40.00	KZIZ - 5	3151 000 034
8916.40.00	KZIZ - 5	3151 169 131
8916.40.00	KZIZ - 5	3151 169 332
8916.40.00	KZIZ - 5	3151 273 431
8917.40.00	KZIZ - 5	3151 245 032
8918.40.00	KZISZ - 5	3100 002 255
8918.40.00	KZISZ - 5	3151 000 155
8918.40.00	KZISZ - 5	3151 259 001
8918.40.00	KZISZ - 5	3151 259 031

Comparison list by RUEN

RUEN reference	Parameter	Comparison refer.
----------------	-----------	-------------------

SACHS

>>

8918.40.00	KZISZ - 5	3180 000 001
8919.40.00	KZISZ - 5	3151 000 144
8919.40.00	KZISZ - 5	3151 203 031
8919.40.00	KZISZ - 5	3151 225 001
8919.40.00	KZISZ - 5	3151 225 031
8923.40.00	KZIZ - 5	3151 000 272
8925.40.00	KZISZ-5	3151 000 163
8928.40.00	KZIZ - 5	3151 245 031
8934.40.00	KZISZ - 5	3151 000 151
8935.40.00	KZISZ - 5	3151 000 157
8935.40.00	KZISZ - 5	3151 195 032
8935.40.00	KZISZ - 5	3151 195 033
8936.40.00	KZISZ - 5	3151 000 493
8936.40.00	KZISZ - 5	3151 234 132
8937.40.00	KZIZS-5	3151 250 231
8939.40.00	KZISZ - 5	3151 000 493
8944.40.00	KZIZ-5	3151 000 335
8944.40.00	KZIZ-5	3151 027 731
8946.46.00	KZIZ-5	3100 276 433
8951.40.00	KZISZ-5	3151 000 497
9101.40.00	KZI - 5	3151 182 233

VALEO

1800.90.02		801 939
1801.20.00	T180120	802 308
1801.30.00	180DE2R	803 393
2023.20.00	DB200	079 800
2023.20.00	DB200	094 492
2023.20.00	DB200	279 165
2023.20.00	DB200	279 421
2023.20.00	DB200	802 321
2034.30.00	200CE	279 379
2042.20.00	CP20	263 105
2042.20.00	CP20	279 458
2150.90.06		003 446
2150.90.07		801 250
2150.90.10		801 040
2150.90.18		003 398
2159.30.00	215CE	265 529
2159.30.00	215CE	266 244
2171.20.00	MF215K	264 635
2171.20.00	MF215K	358 320
2172.30.00	215D	355 575
2172.30.00	215D	355 576
2185.20.00	CP215	266 923
2185.20.00	CP215	267 426
2280.90.02		801 435
2280.90.03		801 546
2282.20.00	M228KR	358 262
2282.20.00	M228KR	805 602
2283.20.00	M228KR	358 262
2306.30.00	228GSB	806 183
2307.30.00	228CB	358 279
2350.90.01		801 409
2353.20.00	MFZ235	805 531
2400.90.04		801 881
2400.90.05		826 585
2402.20.00	MF240	279 118
2402.30.00	240PSD	279 375
2403.20.00	MF240	279 389
2403.20.00	MF240	358 200
2507.20.00	HBX250	355 125
2514.20.00	H250K	261 673
2514.30.00	250CBL	806 137

RUEN reference	Parameter	Comparison refer.
2518.20.00	G250	805 750
2528.30.00	250BHZX	806 019
2528.30.00	250BHZX	807 540
2802.20.00	G280	805 707
2810.20.00	H280K	472 020
2810.30.00	280CBL	806 092
2812.20.00	HVB280	357 978
2813.30.00	280BHZ	806 097
2822.30.00	280GTZ	806 113
2953.20.00	GF295	355 131
2954.30.00	295BHZ	355 132
3101.20.00	GFX310	805 645
3104.30.00	310GSBL	358 338
3120.20.00	GFX310	355 140
3122.20.00	GFX310	805 691
3126.30.00	310GSBL	355 338
3131.20.00	G310	805 752
3133.30.00	310GSBL	583 314
3133.30.00	310GSBL	583 314 TUR.
3133.30.00	310GSBL	829 309 TUR.
3133.30.00	310GSBL	829 367
3133.30.00	310GSBL	829 367 TUR.
3136.30.00	310WGSZ	806 117
3162.20.00	MF310	805 607
3164.20.00	MF310	805 525
3174.20.00	MF310	583 584
3188.20.00	MFZ 310	178 622 TUR.
3188.20.00	MFZ 310	831 314 TUR.
3205.40.00	KZIS - 0	804 022
3206.40.00	KZIS - 1	358 275
3209.40.00	KZAS - 1	275 853
3211.40.00	KZIS - 0	264 630
3212.40.00	KZI - 0	804 106
3214.40.00	KZI/T - 1	355 591
3214.40.00	KZI/T - 1	804 019
3216.40.00	KZAS - 0	265 315
3224.40.00	KZAS - 00	266 121
3233.40.00	KZAS - 0B	804 007
3300.20.00	GFM330	358 295
3300.30.00	330GSZ	358 296
3305.20.00	GMF330	805 564
3309.30.00	330GSZ	806 128
3325.30.00	330WGSZ	806 432
3510.30.00	350W2GSZ	355 164
3516.10.00	GF2/350	805 172
3517.30.00	350WGSZ	806 450
3519.30.00	350GSZ	355 128
3521.20.00	GF350KR	355 104
3522.20.00	GF350KR	355 106
3522.20.00	GF350KR	355 108
3525.20.00	GF350KR	358 336
3528.30.00	350GSZ	355 176
3562.20.00	GMF350	358 282
3563.20.00	GMF350	358 192
3565.20.00	GMF350	358 280
3570.30.00	350Z	806 013
3574.20.00	14" MF 350	805 508
3574.20.00	14" MF 350	831 320
3574.20.00	14" MF 350	831 322
3580.20.00	GMF350	582 472
3580.20.00	GMF350	805 566
3583.30.00	350GSZ	806 018
3597.30.00	350 WGTZ	829 366
3606.20.00	MF362	805 779
3804.20.00	G380KR	355 111
3804.20.00	G380KR	805 748

Comparison list by RUEN

RUEN reference	Parameter	Comparison refer.
VALEO >>		
3807.20.00	G380KR	805 646
3812.30.00	380GSZ	357 810
3812.30.00	380GSZ	358 810
3821.20.00	GF380KR	355 165
3821.30.00	380GSZ	806 021
3822.20.00	GF380KR	355 146
3822.30.00	380GSZ	355 130
3829.20.00	GF380KR	358 331
3852.30.00	380GS	358 333
3857.10.00	GF2/380	805 175
3857.20.00	G380KR	805 708
3860.20.00	GM380K	805 643
3866.20.00	GM380K	263 645
3866.20.00	GM380K	279 014
3868.20.00	15" GM380	831 317
3878.20.00	GMF380	358 332
3882.10.00	GF2/380	805 176
3882.20.00	GF2/380	805 601
3884.30.00	15" 380GSZ	829 365
3886.30.00	380GSZ	807 722
3892.30.00	380GSZ	806 315
3951.20.00	MF395	805 842
3961.30.00	395GTZ	829 358
4201.20.00	G420KR	355 102
4203.30.00	420GS	806 476
4205.20.00	G420KR	355 119
4211.20.00	G420KR	355 100
4222.20.00	GF420KR	355 141
4222.20.00	GF420KR	805 549
4224.20.00	GF420KR	805 649
4226.20.00	GF420KR	355 149
4231.30.00	420GSZ	355 139
4234.20.00	GF420KR	805 549
4235.20.00	GF420KR	355 138
4235.30.00	420/210GS	807 542
4236.20.00	GF420KR	805 809
4244.20.00	GFX420KR	358 350
4244.30.00	420/210GSZ	355 153
4248.20.00	GFX420KR	355 150
4250.30.00	420WGSZ	806 363
4254.30.00	420GSZ	355 101
4257.20.00	GMF420K	355 178
4257.30.00	420GSZ	806 478
4258.30.00	420GSZ	806 012
4261.20.00	GMF420K	358 335
4261.30.00	420GSZ	807 518
4263.20.00	GMF420K	094 185
4263.20.00	GMF420K	805 726
4272.30.00	420WGSZ	806 179
4300.20.00	MFZ430	805 642
4300.90.01		805 028
4300.90.03		805 164
4300.90.05		805 062
4300.90.05		805 186
4300.90.09		805 450
4300.90.09		805 454
4300.90.11		805 073
4300.90.11		805 453
4300.90.51		827 052
4301.20.00	MFZ430	805 600
4301.20.00	MFZ430	805 724
4304.20.00	MFZ430	508 028
4304.20.00	MFZ430	805 711
4305.20.00	MFZ430	805 513

















RUEN reference	Parameter	Comparison refer.
4305.20.00	MFZ430	805 831
4305.30.00	430W2GTZ	806 015
4305.30.00	430W2GTZ	806 190
4306.30.00	430WGTZ	806 449
4306.30.00	430WGTZ	807 507
4306.30.00	430WGTZ	807 575
4307.20.00	MFZ430	805 633
4311.20.00	MFZ430	805 785
4311.30.00	430W2GTZ	806 024
4311.30.00	430W2GTZ	807 571
4312.30.00	430W2GTZ	807 508
4312.30.00	430W2GTZ	807 573
4313.20.00	MFZ430	805 632
4313.20.00	MFZ430	831 030
4326.30.00	430WGTZ	806 441
4326.30.00	430WGTZ	807 558
4327.30.00	430GTZ	806 200
4327.30.00	430GTZ	806 443
4327.30.00	430GTZ	807 558
4328.20.00	MFZ430	805 786
4328.20.00	MFZ430	805 787
4329.60.00	MFZ430	805 781
4332.60.00	MFZ430	805 798
4332.60.00	MFZ430	805 801
4333.30.00	430WGTZ	807 545
4334.30.00	430GTZ	807 503
4500.40.00	KZIZ - 3	806 507
4502.40.00	KZI - 1	279 431
6901.40.00	KZI - 3	358 297
6905.40.00	KZIS - 3	806 504
6908.40.00	KZ - 3	358 546
6908.40.00	KZ - 3	358 547
8401.40.00	KZI - 4,5	806 662
8500.40.00	KZI - 4,5	358 286
8505.40.00	KZI - 4,5	806 615
8509.40.00	KZI - 4,5	358 281
8511.40.00	KZI - 4,5	806 532
8514.40.00	KZI - 4,5	358 511
8520.40.00	KZI - 4,5	806 529
8900.40.00	KZI - 5	358 323
8905.40.00	KZIZ - 5	806 611
8916.40.00	KZIZ - 5	806 616
8918.40.00	KZISZ - 5	806 677
8919.40.00	KZISZ - 5	806 508
8934.40.00	KZISZ - 5	830 010
8937.40.00	KZISZ-5	806 675
9101.40.00	KZI - 5	830 007

Contents

Clutches for busses





Vehicle list	1
BARKAS	1
BMC (TÜRKİYE)	1
BOVA	1
DAF	2
DRÖGMÖLLER	3
ENASA	4
EVOBUS	4
FIAT	11
FORD	12
GÜLERYÜZ (TÜRKİYE)	13
IKARUS	14
IKARUS (TÜRKİYE)	14
IRISBUS	15
IVECO	16
KAMAZ	21
LAZ	22
MAGIRUS-DEUTZ	22
MAN	30
MAN (TÜRKİYE)	45
MAZ	45
MERCEDES (TÜRKİYE)	46
MERCEDES-BENZ	47
NEOPLAN	66
ÖSTERREICHISCHE AUTOMOBILFABRIK (OAF)	86
OTOKAR (TÜRKİYE)	86
PEUGEOT	87
RENAULT	87
RENAULT TRUCKS	88
SCANIA	91
SETRA	93
SETRA (TÜRKİYE)	94
TAM	95
TEMSA	96
TEMSA (TÜRKİYE)	96
TEZELLER-TÜRKKAR (TÜRKİYE)	96
VAN HOOL	96
VOLVO	98
YUTONG	105
ZASRAVA	105
Arithmetical List	107
Cross reference list	129
Comparison list by manufacturer	139
Comparison list by RUEN	149

Symbols

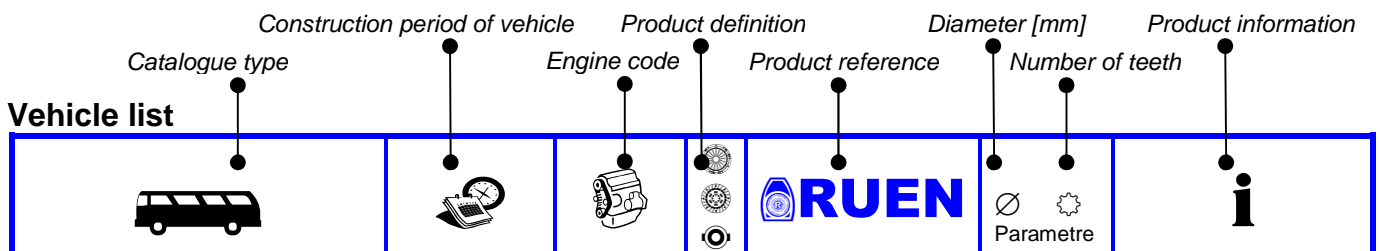
	Passenger cars
	Commercial vehicles
	Busses
	Tractors
	Clutch Kit
	Cover assembly
	Clutch Disc
	Release bearing
	Only available as kit
	Release bearing fitted to the cover assembly
	Optional design
	Without releaser
	Transmission side
	Engine side
	Heavy duty version
	In development

Catalogue layout



MERCEDES-BENZ						
OS 1831 - 1860		04.96 -				
1831 AK 1831 K		04.97 - 10.02 04.97 - 10.02	OM 541.920 OM 541.926 OM 541.941	 4000.90.02 ⊕  4012.10.00  4012.30.00  8922.40.00	400 18 MFZ2/400 400WGVZ KZISZ-5	- Equipment Var: SA50468204
<i>Vehicle type</i>	<i>Vehicle model</i>	<i>Vehicle manufacturer</i>	<i>Construction period</i>	<i>Product criteria</i>		

Measuring scale

- Profiles in inches

Mark	∅ d1 Mm	∅ d2 mm	b mm
5/8 "	13.7	16.1	2.50
7/8 "	19.1	22.2	3.45
1 "	20.6	25.8	3.93
1 1/8 "	23.4	28.9	4.45
1 1/4 "	25.8	32.1	4.93
1 3/8 "	28.7	35.2	5.43
1 1/2 "	30.7	38.4	5.89
1 5/8 "	33.4	41.3	6.40
1 3/4 "	36.0	44.5	6.88
2SAE "	41.1	50.8	7.88

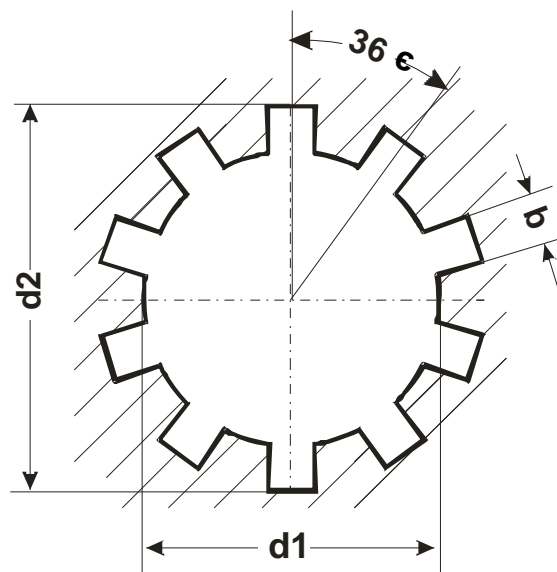

Übersetzung

Arithmetical list	Arithmetische Liste
Box	Kasten
Bus	Bus
Cab with engine	Triebkopf
Catalogue layout	Katalogaufbau
Catalogue type	Katalogtyp
Chassis no.	Fahrgestellnu.
Clutch Disc	Kupplungsscheibe
Clutch Kit	Kupplungssatz
Clutches for busses	Kupplungen für Busse
Clutches for commercial vehicles	Kupplungen für Nkw
Clutches for passenger cars	Kupplungen für Pkw
Clutches for tractors	Kupplungen für Traktoren
Comparison list by manufacturer	Vergleichsliste des Herstellers
Comparison list by RUEN	Vergleichsliste von RUEN
Comparison refer.	Vergleichsreferenz
Concrete Mixer	Betonmischer
Construction period of vehicle	Bauzeitraum des fahrzeugs
Contained in xxxx.10.00	In xxxx.10.00 enthalten
Contained in xxxx.60.00	In xxxx.60.00 enthalten
Contents	Inhalt
Convertible	Cabriolet
Coupe	Coupe
Cover assembly	Kupplungsdeckel
Cross reference list	Kreuzverweisliste
Diameter [mm]	Durchmesser [mm]
Diesel	Diesel
Dump Truck	Kipper
Engine code	Motornummer
Engine side	Motorseitig
Equipment Var	Ausgerüstet mit
Estate	Kombi
Flatbed/Chassis	Pritsche/Fahrgestell
For	Für
For PTO	Für nebenantrieb
From chassis no.	Ab fahrgestellnu.
From engine no.	Ab motornummer
From model year	Ab baujahr
From transmission no.	Ab getriebenummer
GBox	Getriebe
Hatchback	Schrägheck
Heavy duty version	Verstärkte ausführung
Hub profile	Nabenprofil
In development	In entwicklung
Loose clutch disc	Lose kupplungsscheibe
Manufacturer	Hersteller
Mark	Benennung
Measuring scale	Maßtabelle
Memo	Memo
MPV	Großraumlimousine
Not for chassis no.	Nicht für fahrgestellnummer
Number of teeth	Zähnezahl

Übersetzung

OEM reference	OEM Referenz
Off-Road Vehicle	Geländewagen
Only available as kit	Nur als satz lieferbar
Only install if the vehicle is equipped with an M-type clutch	Nur verbauen, wenn fahrzeug mit M-Kupplung ausgerüstet ist
Only install together	Nur zusammen verbauen
Optional design	Mahlweise
Page	Seite
Parameter	Parameter
Petrol	Benzin
Pickup	Pick-up
Platform/Chassis	Plattform/Fahrgestell
Product criteria	Produktkriterien
Product definition	Produktdefinition
Product description	Produktbeschreibung
Product information	Produktinformationen
Profiles in inches	Zollprofile
Reference	Referenz
Release bearing	Ausrücker
Release bearing fitted to the cover assembly	Ausrücker montiert mit kupplungsdeckel
RUEN - Products Catalogue 2018/19	RUEN - Produktkatalog 2018/19
RUEN reference	RUEN Referenz
Saloon	Stufenheck
See parts list for components	Siehe Teileliste
Special design	Sonderausführung
Special design	Sonderanfertigung
Symbols	Symbole
This part number includes one clutch disc	Diese artikelnummer enthält eine kupplungsscheibe
To chassis no.	Bis fahrgestellnu.
To engine no.	Bis motornummer
To model year	Bis baujahr
To transmission no.	Bis getriebenummer
Translation	Übersetzung
Transmission Number	Getriebenummer
Transmission side	Getriebeseitig
Transmission type	Getriebetyp
Truck Tractor	Sattelzugmaschine
Use release fork with cam	Ausrückgabel mit nocken verwenden
Use release fork with rollers	Ausrückgabel mit rollen verwenden
Utility truck	Kommunalfahrzeug
Van/Estate	Kasten/Kombi
Vehicle list	Fahrzeugliste
Vehicle manufacturer	Fahrzeughersteller
Vehicle model	Fahrzeugmodell
Vehicle type	Fahrzeugtyp
Vehicles with double disc clutch	Fahrzeuge mit zweiseibenkupplung
Vehicles with single clutch disc	Fahrzeuge mit einscheibenkupplung
Without releaser	Ohne ausrücker

Traduction

Arithmetical list	Liste arithmétique
Box	Boîte
Bus	Châssis autocar
Cab with engine	Châssis-cabine
Catalogue layout	Mise en page du catalogue
Catalogue type	Type de catalogue
Chassis no.	Châssis n°
Clutch Disc	Disque d'embrayage
Clutch Kit	Kit d'embrayage
Clutches for busses	Embrayages pour autobus
Clutches for commercial vehicles	Embrayages pour véhicules commerciaux
Clutches for passenger cars	Embrayages pour automobiles
Clutches for tractors	Embrayages pour tracteurs
Comparison list by manufacturer	Liste comparative par fabricant
Comparison list by RUEN	Liste comparative de RUEN
Comparison refer.	Référence de comparaison
Concrete Mixer	Bétonnière
Construction period of vehicle	Période de fabrication du véhicule
Contained in xxxx.10.00	Contenu dans xxxx.10.00
Contained in xxxx.60.00	Contenu dans xxxx.60.00
Contents	Table des matières
Convertible	Cabriolet
Coupe	Coupé
Cover assembly	Mécanisme d'embrayage
Cross reference list	Liste des références croisées
Diameter [mm]	Diamètre [mm]
Diesel	Diesel
Dump Truck	Camion benne
Engine code	Code moteur
Engine side	Côté moteur
Equipment Var	Equipé pour
Estate	Combi break/Véhicule industriel léger
Flatbed/Chassis	Camion Plate-forme/Châssis
For	Pour
For PTO	Pour commande auxiliaire
From chassis no.	A partir de châssis n°
From engine no.	A partir de moteur n°
From model year	A partir année de fabrication
From transmission no.	A partir de transmission n°
GBox	Boîte de vitesse
Hatchback	3/5 portes
Heavy duty version	Modèle renforcé
Hub profile	Cannelure de moyeu
In development	En développement
Loose clutch disc	Disque d'embrayage amovible
Manufacturer	Fabricant
Mark	Marque
Measuring scale	Echelle de mesure
Memo	Mémo
MPV	Monospace
Not for chassis no.	Ne convient pas au châssis n°
Number of teeth	Nombre de dentures

Traduction

OEM reference	OEM référence
Off-Road Vehicle	Véhicule tout terrain
Only available as kit	Uniquement disponible en kit
Only install if the vehicle is equipped with an M-type clutch	Installer uniquement si le véhicule est équipé du
Only install together	Installe uniquement ensemble
Optional design	Au choix
Page	Page
Parameter	Paramètre
Petrol	Essence
Pickup	Pick-up
Platform/Chassis	Plate-forme/Châssis
Product criteria	Critères du produit
Product definition	Définition du produit
Product description	Description du produit
Product information	Information sur le produit
Profiles in inches	Profile en pouces
Reference	Référence
Release bearing	Butée d'embrayage
Release bearing fitted to the cover assembly	Butée fixée sur le mécanisme d'embrayage
RUEN - Products Catalogue 2018/19	RUEN - Catalogue des produits 2018/19
RUEN reference	Référence RUEN
Saloon	Saloon
See parts list for components	Voir liste des pièces
Special design	Modèle spécial
Symbols	Symboles
This part number includes one clutch disc	Cette pièce comprend un disque d'embrayage
To chassis no.	Jusqu'à châssis n°
To engine no.	Jusqu'à moteur n°
To model year	Jusqu'à année de fabrication
To transmission no.	Jusqu'à transmission n°
Translation	Traduction
Transmission Number	Numéro de transmission
Transmission side	Côté transmission
Transmission type	Type de transmission
Truck Tractor	Camion-tracteur
Use release fork with cam	Utiliser fourche d'embrayage avec cames
Use release fork with rollers	Utiliser fourche d'embrayage avec rouleaux
Utility truck	Véhicule communal
Van/Estate	Van
Vehicle list	Liste véhicules
Vehicle manufacturer	Fabricant du véhicule
Vehicle model	Modèle de véhicule
Vehicle type	Type de véhicule
Vehicles with double disc clutch	Véhicule à embrayage bi-disque
Vehicles with single clutch disc	Véhicule à embrayage monodisque
Without releaser	Sans butée

Превод

Arithmetical list	Аритметичка листа
Box	Кутија
Bus	Автобус
Cab with engine	Погонска единица
Catalogue layout	Изглед на каталогот
Catalogue type	Тип на каталог
Chassis no.	Шасија бр.
Clutch Disc	Диск
Clutch Kit	Комплет спојница
Clutches for busses	Спојници за автобуси
Clutches for commercial vehicles	Спојници за комерцијални возила
Clutches for passenger cars	Спојници за патнички возила
Clutches for tractors	Спојници за трактори
Comparison list by manufacturer	Споредбена листа по производител
Comparison list by RUEN	Споредбена листа по RUEN
Comparison refer.	Споредбена ознака
Concrete Mixer	Мешалица за бетон
Construction period of vehicle	Период на изработка на возилото
Contained in xxxx.10.00	Содржано во xxxx.10.00
Contained in xxxx.60.00	Содржано во xxxx.60.00
Contents	Содржина
Convertible	Кабриолет
Coupe	Купе
Cover assembly	Нападно тело
Cross reference list	Вкрстена листа
Diameter [mm]	Диаметар [mm]
Diesel	Дизел
Dump Truck	Камион Кипер
Engine code	Број на мотор
Engine side	На страна на моторот
Equipment Var	Опремен со
Estate	Комбе
Flatbed/Chassis	Рамна шасија
For	За
For PTO	За РТО
From chassis no.	Од шасија
From engine no.	Од мотор број
From model year	До година на производство
From transmission no.	Од менувач број
GBox	Менувач
Hatchback	Задна врата
Heavy duty version	HD верзија
Hub profile	Хаб профил
In development	Во развој
Loose clutch disc	Неприцврстен диск
Manufacturer	Производител
Mark	Ознака
Measuring scale	Мерна скала
Memo	Белешки
MPV	Моноволумец
Not for chassis no.	Не за шасија број
Number of teeth	Број на заби

Превод

OEM reference	ОЕМ ознака
Off-Road Vehicle	Теренско возило
Only available as kit	Достапен само како комплет
Only install if the vehicle is equipped with an M-type clutch	Се инсталира само доколку возилото е опремено со М-тип на спојка
Only install together	Се инсталира само заедно
Optional design	По избор
Page	Страна
Parameter	Параметар
Petrol	Бензин
Pickup	Пикап
Platform/Chassis	Платформа/Шасија
Product criteria	Критериуми за производот
Product definition	Дефиниција на производот
Product description	Опис на производот
Product information	Информации за производот
Profiles in inches	Профили во инчи
Reference	Ознака
Release bearing	Исклучно лежиште
Release bearing fitted to the cover assembly	Лежиштето вградено со потисната плоча
RUEN - Products Catalogue 2018/19	RUEN - Каталог на производи 2018/19
RUEN reference	RUEN ознака
Saloon	Седан
See parts list for components	Да се види листа на делови за компонентите
Special design	Специјален дизајн
Symbols	Симболи
This part number includes one clutch disc	Оваа референца содржи еден диск
To chassis no.	До шасија
To engine no.	До мотор број
To model year	Од година на производство
To transmission no.	До менувач број
Translation	Превод
Transmission Number	Број на менувач
Transmission side	На страна на менувачот
Transmission type	Тип на менувач
Truck Tractor	Камион Влекач
Use release fork with cam	Користи исклучна вилушка со брег
Use release fork with rollers	Користи исклучна вилушка со валци
Utility truck	Комунално возило
Van/Estate	Комбе
Vehicle list	Листа по возила
Vehicle manufacturer	Производител на возила
Vehicle model	Модел на возило
Vehicle type	Тип на возило
Vehicles with double disc clutch	Возило со двоен диск
Vehicles with single clutch disc	Возило со единечен диск
Without releaser	Без лежиште

Prevod

Arithmetical list	Aritmetička lista
Box	Box
Bus	Autobus
Cab with engine	Kabina sa motorom
Catalogue layout	Izgled kataloga
Catalogue type	Tip kataloga
Chassis no.	Broj šasiije
Clutch Disc	Lamela
Clutch Kit	Set kvačila
Clutches for busses	Kvačila za autobuse
Clutches for commercial vehicles	Kvačila za komercijalna vozila
Clutches for passenger cars	Kvačila za putnička vozila
Clutches for tractors	Kvačila za traktore
Comparison list by manufacturer	Uporedna lista po proizvođaču
Comparison list by RUEN	Uporedna lista po RUENU
Comparison refer.	Uporedna oznaka
Concrete Mixer	Mešalica betona
Construction period of vehicle	Period izrade vozila
Contained in xxxx.10.00	Sadržano u xxxx.10.00
Contained in xxxx.60.00	Sadržano u xxxx.60.00
Contents	Sadržaj
Convertible	Kabriolet
Coupe	Kupe
Cover assembly	Korpa kvačila
Cross reference list	Ukrštena lista
Diameter [mm]	Dijametar [mm]
Diesel	Dizel
Dump Truck	Kamion-kiper
Engine code	Broj motora
Engine side	Na strani motora
Equipment Var	Opremljen sa
Estate	Estate
Flatbed/Chassis	Ravna šasija
For	Za
For PTO	Za pogon na dodatnu osovinu
From chassis no.	Od šasiije
From engine no.	Od broja motora
From model year	Od godine proizvodnje
From transmission no.	Od broja mjenjača
GBox	Menjač
Hatchback	Peta vrata
Heavy duty version	Ojačana verzija
Hub profile	Presek osovine
In development	U razvoju
Loose clutch disc	Nepričvršćena lamela
Manufacturer	Proizvođač
Mark	Oznaka
Measuring scale	Merna skala
Memo	Beleške
MPV	MPV
Not for chassis no.	Ne za broj šasiije
Number of teeth	Broj zuba

Prevod

OEM reference	OEM oznaka
Off-Road Vehicle	Terensko vozilo
Only available as kit	Dostupno samo kao set
Only install if the vehicle is equipped with an M-type clutch	Instalirati samo ukoliko je vozilo opremljeno sa kvačilom M-tipa
Only install together	Instalirati samo zajedno
Optional design	Po izboru
Page	Strana
Parameter	Parametar
Petrol	Benzin
Pickup	Pick up
Platform/Chassis	Platforma/šasija
Product criteria	Kriterijum proizvoda
Product definition	Definicija proizvoda
Product description	Opis proizvoda
Product information	Informacija o proizvodu
Profiles in inches	Profili u inčima
Reference	Oznaka
Release bearing	Isključni ležaj
Release bearing fitted to the cover assembly	Isključni ležaj ugrađen na korpu kvačila
RUEN - Products Catalogue 2018/19	RUEN - Katalog proizvoda 2018/19
RUEN reference	RUEN oznaka
Saloon	Saloon
See parts list for components	Vidi listu delova za komponente
Special design	Specijalni dizajn
Symbols	Simboli
This part number includes one clutch disc	Ova referenca sadrži jednu lamelu
To chassis no.	Do šasije
To engine no.	Do broja motora
To model year	Do godine proizvodnje
To transmission no.	Do broja mjenjača
Translation	Prevod
Transmission Number	Broj mjenjača
Transmission side	Na strani menjača
Transmission type	Tip mjenjača
Truck Tractor	Tegljac Traktor
Use release fork with cam	Koristi isključnu viljušku sa bregom
Use release fork with rollers	Koristi isključnu viljušku sa valjcima
Utility truck	Komunalno vozilo
Van/Estate	Van/Estate
Vehicle list	Lista vozila
Vehicle manufacturer	Proizvođač vozila
Vehicle model	Model vozila
Vehicle type	Tip vozila
Vehicles with double disc clutch	Vozilo sa duplim kvačilom
Vehicles with single clutch disc	Vozilo sa jednostrukim kvačilom
Without releaser	Bez isključnog ležaja

Перевод

Arithmetical list	Арифметический лист
Box	Коробка
Bus	Автобус
Cab with engine	Двигательная единица
Catalogue layout	Внешний вид каталога
Catalogue type	Тип каталога
Chassis no.	Код шасси
Clutch Disc	Ведомый диск сцепления
Clutch Kit	Комплект
Clutches for busses	Сцепления для автобусов
Clutches for commercial vehicles	Сцепления для грузовых автомобилей
Clutches for passenger cars	Сцепления для легковых автомобилей
Clutches for tractors	Сцепления для тракторов
Comparison list by manufacturer	Сопоставительный лист по производителям
Comparison list by RUEN	Сопоставительный лист по РУЕНе
Comparison refer.	Сопост. номер
Concrete Mixer	Бетономешалка
Construction period of vehicle	Срок изготовления автомобиля
Contained in xxxx.10.00	Входящий в состав xxxx.10.00
Contained in xxxx.60.00	Входящий в состав xxxx.60.00
Contents	Содержание
Convertible	Кабриолет
Coupe	Купе
Cover assembly	Нажимный диск сцепления
Cross reference list	Перекрестный ссылочный лист
Diameter [mm]	Диаметр [мм]
Diesel	Дизель
Dump Truck	Самосвал
Engine code	Код двигателя
Engine side	Со стороне двигателя
Equipment Var	Оборудован с
Estate	Фургон
Flatbed/Chassis	Шасси
For	Для
For PTO	Для ПТО
From chassis no.	От шасси но.
From engine no.	От кода двигателя но.
From model year	До года выпуска модели
From transmission no.	От КП но.
GBox	Передача
Hatchback	Задняя дверь
Heavy duty version	Версия для тяжелого режима работы
Hub profile	Профиль узла
In development	В развитие
Loose clutch disc	Незакрепленный диск
Manufacturer	Производитель
Mark	Знак
Measuring scale	Измерительная шкала
Memo	Записка
MPV	Лимузин
Not for chassis no.	Не соответствует для шасси но.
Number of teeth	Количество зубьев

Перевод

OEM reference	ОЕМ номер
Off-Road Vehicle	Автомобиль для бездорожья
Only available as kit	Доступный только в комплекте
Only install if the vehicle is equipped with an M-type clutch	Устанавливать только если автомобиль оборудован со сцеплением М-типа
Only install together	Устанавливать только совместно
Optional design	Произвольный выбор
Page	Страница
Parameter	Параметр
Petrol	Бензин
Pickup	Пикап
Platform/Chassis	Платформа/Шасси
Product criteria	Критерий продукта
Product definition	Дефиниция продукта
Product description	Описание продукта
Product information	Информации о продукте
Profiles in inches	Профили в дюймах
Reference	Ссылочный номер
Release bearing	Подшипник расцепителя
Release bearing fitted to the cover assembly	Расцепитель установлен на нажимном диске
RUEN - Products Catalogue 2018/19	РУЕН - Каталог продуктов 2018/19
RUEN reference	Номер РУЕНа
Saloon	Седан
See parts list for components	Посмотри список составных частей
Special design	Специальный дизайн
Symbols	Символы
This part number includes one clutch disc	Настоящий ссылочный номер содержит только один диск
To chassis no.	По шасси но.
To engine no.	По коду двигателя но.
To model year	От года выпуска модели
To transmission no.	По КП но.
Translation	Перевод
Transmission Number	Код коробки передачи
Transmission side	Со стороне коробки передачи
Transmission type	Тип КП
Truck Tractor	Трактор-тягач
Use release fork with cam	Пользуется выкл. свернутой вилкой
Use release fork with rollers	Пользуется выкл. вилкой с роликами
Utility truck	Коммунальный автомобиль
Van/Estate	Автофургон
Vehicle list	Список автомобилей
Vehicle manufacturer	Производитель автомобилей
Vehicle model	Модель автомобиля
Vehicle type	Тип автомобиля
Vehicles with double disc clutch	Автомобиль с удвоенным диском
Vehicles with single clutch disc	Автомобиль с единичным диском
Without releaser	Без расцепителя

Çeviri

Arithmetical list	Aritmetik Liste
Box	Vites Kutusu
Bus	Otobüs
Cab with engine	Motorlu Kabin
Catalogue layout	Katalog Düzeni
Catalogue type	Katalog Tipi
Chassis no.	Şasi No.
Clutch Disc	Debriyaj diski
Clutch Kit	Debriyaj Seti
Clutches for busses	Otobüsler İçin Debriyajlar
Clutches for commercial vehicles	Ticari Araçlar İçin Debriyajlar
Clutches for passenger cars	Binek Araçları için Debriyajlar
Clutches for tractors	Traktörler İçin Debriyajlar
Comparison list by manufacturer	OEM Geçiş Listesi
Comparison list by RUEN	Tirsan Geçiş Listesi
Comparison refer.	Karşılaştırma Refer.
Concrete Mixer	Beton Mikseri
Construction period of vehicle	Araç Üretim Tarih Aralığı
Contained in xxxx.10.00	xxxx.10.00 içinde bulunan
Contained in xxxx.60.00	xxxx.60.00 içinde bulunan
Contents	İçerik
Convertible	Cabriolet
Coupe	Coupe
Cover assembly	Debriyaj Baskısı
Cross reference list	Çapraz Geçiş Listesi
Diameter [mm]	Çap [mm]
Diesel	Dizel
Dump Truck	Damperli Kamyon
Engine code	Motor Kodu
Engine side	Motor Tarafı
Equipment Var	Ekipman var
Estate	Arazi Taşıtı
Flatbed/Chassis	Düz/Şasi
For	İçin
For PTO	PTO İçin
From chassis no.	Şasi No' dan İtibaren
From engine no.	Motor No' dan İtibaren
From model year	Model Yılından İtibaren
From transmission no.	Şanzıman No'dan itibaren
GBox	Vites Kutusu
Hatchback	Hatchback
Heavy duty version	Ağır Hizmet Tipi
Hub profile	Göbek Profili
In development	Geliştirilmekte
Loose clutch disc	Hareketli Debriyaj Diski
Manufacturer	OEM
Mark	Markalama
Measuring scale	Ölçü Tablosu
Memo	Hatırlatma
MPV	MPV
Not for chassis no.	Şasi No'su İçin Değil
Number of teeth	Diş Sayısı

Çeviri

OEM reference	OEM Referansı
Off-Road Vehicle	OFF Road Araç
Only available as kit	Sadece kit olarak kullanılabilir
Only install if the vehicle is equipped with an M-type clutch	Yalnızca M-tipi Debriyaj ile Donatılmış araç ise
Only install together	Sadece Birlikte Kullanılabilir
Optional design	İsteğe Bağlı Tasarım
Page	Sayfa
Parameter	Parametre
Petrol	Benzinli
Pickup	Pickup
Platform/Chassis	Platform/Şasi
Product criteria	Ürün Kriterleri
Product definition	Ürün Tanımı
Product description	Ürün Açıklaması
Product information	Ürün Bilgisi
Profiles in inches	Inch Ölçü Profilleri
Reference	Referans
Release bearing	Debriyaj Rulmanı
Release bearing fitted to the cover assembly	Debriyaj Rulmanı Baskıya Montajlı
RUEN - Products Catalogue 2018/19	RUEN - Debriyaj Ürün Kataloğu 2018/19
RUEN reference	Tirsan Referansı
Saloon	Sedan
See parts list for components	Bileşenleri için parça listesine bakınız
Special design	Özel Tasarım
Symbols	Semboller
This part number includes one clutch disc	Bu Parça No Bir Debriyaj Diski İçindir
To chassis no.	Şasi No.na kadar
To engine no.	Motor No'suna Kadar
To model year	Model Yılı
To transmission no.	Şanzıman No'suna Kadar
Translation	Çeviri
Transmission Number	Şanzıman Numarası
Transmission side	Şanzıman Tarafı
Transmission type	Şanzıman Tipi
Truck Tractor	Çekici
Use release fork with cam	Kam ile Çalışan Serbest Çatal Kullanımı
Use release fork with rollers	Makara ile Çalışan Serbest Çatal Kullanımı
Utility truck	Çok Amaçlı Kamyon
Van/Estate	Van/Kasa
Vehicle list	Araç Listesi
Vehicle manufacturer	Araç Üreticisi
Vehicle model	Araç Modeli
Vehicle type	Araç Tipi
Vehicles with double disc clutch	Çift Debriyaj Diskli Araçlar
Vehicles with single clutch disc	Tek Debriyaj Diskli Araçlar
Without releaser	Geri Getirici Olmadan